

Roland



Reference Manual

01: Overview

Describes the top and rear panels of the FA, and the structure of its sound engine and memory.

02: Performing

Explains basic performance operations, such as how to select tones.

03: Performance Functions

Explains convenient functions that you'll use while performing, such as modifying the sound in real time.

04: Editing

Explains how to edit studio sets, tones, and effects.

05: Sequencer (Creating Songs)

Explains how to use the sequencer to play, record and edit songs.

06: Sampler

Explains sampling and sample editing.

07: Pads

Explains how to use the pads.

08: DAW

Explains how to use the FA in conjunction with a computer or DAW controller.

09: Settings

Explains convenient functions, and settings that apply to the entire FA.

10: Appendix

Provides troubleshooting information and lists error messages.

About the PDF manual

The PDF manual lets you quickly search for a term, or view an explanation simply by clicking a link.

* You'll need Adobe Reader (a free download) in order to view the PDF manual.

Contents

01: Overview

5

Panel Descriptions	6
Top Panel	6
Rear Panel (Connecting Your Equipment)	8
An Overview of the FA	10
Overall Structure	10
Synthesizer	10
Sequencer	10
Sampler	10
How the Sound Engine Is Structured	11
Tones	11
Studio Sets	12
About the Effects	13
About Memory	14
About the Sequencer	15
Songs	15
Tracks	15
About the Sampler	16
Getting Ready	17
Placing This Unit on a Stand	17
Turning the Power On/Off	19
Turning the Power On	19
Turning the Power Off	19
Playing the Demo Songs	19

02: Performing

21

Playing One Tone (Single Play)	22
Selecting a Tone	22
Selecting a Tone from a List	23
Playing Two Tones Together (Dual)	24
Changing the Tones	24
Playing Different Tones in the Right and Left Hands (Split)	25
Changing the Tones	25
Changing the Split Point	25
Playing Multiple Parts (Multi Part Play)	26
Viewing the Part Settings (PART VIEW Screen)	26
Selecting the Parts that Sound (Keyboard Switch)	27
Switching Studio Sets	27
Registering/Recalling Favorite Sounds (Favorites)	28
Registering a Sound as a Favorite	28
Recalling a Favorite	28
Registering/Recalling/Editing Favorites in the List	28
Changing the Keyboard Settings	29
Raising/Lowering the Key Range in Semitone Steps (Transpose)	29
Raising/Lowering the Key Range in Octaves (Octave Shift)	29

03: Performance Functions

31

Playing Arpeggios	32
Using the Arpeggiator	32
Setting the Arpeggiator Tempo	32
Holding the Arpeggio (Hold)	32
Arpeggiator Settings	33
Importing a Computer SMF File into an Arpeggio Style (Import SMF)	34
Creating an Arpeggio Style from a Song (Import Song)	34
Using Chord Memory	35
Performing with the Chord Memory Function	35
Chord Memory Settings	35
Performing with Rhythm Patterns	36
Selecting/Playing Rhythm Patterns	36
Changing the Tempo of the Rhythm Pattern	37
Saving a Rhythm Group	37
Importing SMF into a Rhythm Pattern	38
Creating a Rhythm Pattern from a Song	38
Modifying the Sound in Real Time	39
Using the SOUND MODIFY Knobs to Vary the Sound	39
Changing the Tonal Character of the Part (CUTOFF, RESONANCE)	39
Changing How the Volume Will Vary of the Part (ATTACK, RELEASE)	39
Changing the Stereo Position of the Sound of the Part (PAN)	39
Adjusting the Volume of the Part (LEVEL)	39
Adjusting the Level of the Low, Mid, and High Frequencies (EQ)	39
Adjusting the Input Volume (INPUT LEVEL)	39
Applying an Assigned Function (ASSIGN 1–6)	39
Applying Effects Conveniently (GLOBAL CONTROL)	40
Moving Your Hand to Vary the Pitch or Volume (D-BEAM Controller)	41
Changing the Pitch (Pitch Bend)	41
Applying Vibrato or Dynamics (Modulation)	41
Using an Assigned Function to Vary the Sound ([S1] [S2] buttons)	41
Using a Pedal to Vary the Sound	42
Sustaining the Notes (Hold Pedal)	42
Adding Expression to Your Performance (Control Pedal)	42
Performing with a Microphone (Vocoder)	42
Using the Vocoder	42
Editing the Vocoder Settings	42

04: Editing 43

Editing a Studio Set 44
 Overall Settings for the Studio Set 44
 Settings for Each Part. 44
 Saving a Studio Set. 45
 Initializing a Studio Set (Studio Set Init) 45
 Initializing a Part (Part Init). 45

Editing a Tone. 46
 Basic Procedure for Tone Edit 46
 SuperNATURAL Acoustic Tone (SN-A). 46
 SuperNATURAL Synth Tone (SN-S). 46
 SuperNATURAL Drum Kit (SN-D) 47
 PCM Synth Tone (PCMS) 47
 PCM Drum Kit (PCMD) 48
 Saving a Tone/Drum Kit. 48
 Initializing a Tone (Tone Initialize) 48
 Selecting the Partials That Sound (Partial Switch) 49
 Selecting the Partials to Edit (Partial Select) 49
 Initializing a Partial (Partial Initialize) 49
 Copying a Partial (Partial Copy) 49

Editing a Pattern 50
 Initializing a Pattern (Initialize) 50
 Specifying the Time Signature and Length (Setup). 50
 Specifying the Grid Scale (Scale) 50
 Specifying the Note Type, Duration, and Loudness (Note Setup) 51
 Entering Notes 51
 Deleting Notes (Clear Step, Clear Note). 51
 Saving the Pattern. 51

Editing the Effects. 52
 Turning Effects On/off 52
 Editing the Effects of the Studio Set. 53
 Editing the Effects of the Tone 53
 Editing the System Effects 54

05: Sequencer (Creating Songs) 55

Playing Songs. 56
 Selecting and Playing Songs. 56
 Setting the Tempo of the Song 56
 Looping the Song Playback. 57

Recording the Song 58
 Recording Workflow. 58
 Prepare for Recording 58
 Realtime Recording 59
 Selecting the Performance Data to Record (Recording Select) 60
 Removing Unwanted Data During Recording (Realtime Erase) 60
 Auditioning Sounds or Phrases During Recording (Rehearsal Function). 60
 Step Recording. 61
 Canceling a Recording or Edit (Undo/Redo) 62

Editing the Song 63
 Specifying the Sound Engine Played by Each Track 63
 Muting a Part's Performance (MUTE) 63
 Sounding One Part by Itself (SOLO) 63
 Edit Performance Data for Entire Tracks (Track Modify) 64
 Basic Procedure for Track Modify. 64
 Correcting the Song's Timing (Quantize) 64
 Erasing Unwanted Performance Data (Erase) 65
 Deleting Unwanted Measures (Delete) 65
 Copying Performance Data (Copy) 65
 Inserting Blank Measures (Insert) 66
 Transposing (Transpose). 66
 Changing the Velocity (Change Velocity) 66
 Changing the Duration of the Notes (Change Duration). 67
 Moving Performance Data Forward or Backward (Shift Clock) 67
 Editing Individual Events of Performance Data (Microscope) 68
 Selecting the Track to Edit / Viewing Specific Performance Data (View) 69
 Inserting Performance Data (Create) 69
 Erasing Performance Data (Erase) 69
 Moving Performance Data (Move) 70
 Copying/Pasting Performance Data (Copy/Paste) 70
 Changing the Tempo During a Song 71
 Changing the Time Signature During a Song 71
 Adjusting the Pan and Volume Balance (Mixer) 72
 Erasing the Song in the Temporary Area (Song Clear) 72
 Assigning a Name to the Song (Song Name) 72
 Specifying the Song's Time Signature (Time Signature) 73
 Deleting a Song (Delete Song) 73

Saving/Exporting a Song 74
 Save the Song. 74
 Exporting Tracks as Individual WAV Format Files (Multi-track Export). 74
 Exporting a Two-Channel Mix in WAV Format. 75
 Exporting the Song in SMF Format. 75
 Exporting Samples in WAV Format 76
 Importing an SMF as a Song 76

Overview

Performing

Performance Functions

Editing

Sequencer (Creating Songs)

Sampler

Pads

DAW

Settings

Appendix

06: Sampler 77

Playing Samples	78
Selecting/Playing Samples	78
Switching Banks	78
Sampling	79
Sampling Procedure	79
Setting the Input Volume (Input Setting)	80
Moving/Copying a Sample (Clip Board)	80
Moving a Sample	80
Copying a Sample	80
Editing a Sample	81
Editing Procedure	81
Renaming the Sample (Rename)	81
Cutting Unwanted Regions from the Sample (Truncate) ..	81
Deleting a Sample (Delete)	81
Zooming the Sample Display (Zoom)	82
Auditioning the Edited Result (Preview)	82
Exporting the Sample in WAV Format (Export Sample) ...	82
Importing an Audio File (Sample Import)	82
Switching the Sample Information Display (Change Information)	82

07: Pads 83

Using the Pads	84
Specifying the Function of the Pads (PAD UTILITY)	84
Playing Samples (SAMPLE PAD)	84
Selecting Parts (PART SELECT)	84
Switching Part Mute (PART MUTE)	84
Switching the Soloed Part (PART SOLO)	84
Using the Pads as Numeric Keys (NUMERIC)	84
Selecting Partials and Turning Them On/Off (PARTIAL SW/SEL)	84
Turning the Keyboard Switch On/Off (KBD SW)	85

08: DAW 87

Connecting to a Computer via USB	88
Installing the USB Driver	88
Making USB Driver Settings	88
Using the FA with DAW Software	89
Using the FA as a DAW Controller	89
Using the FA to Control DAW Software	89
Assigning Functions to Knobs and Buttons	90
Using the FA as a MIDI Keyboard	90
Playing the FA's Sound Engine from DAW Software	91
Using the FA as an Audio Interface	91
Specifying the USB Audio Output	91
Saving the DAW CONTROL Settings	92

09: Settings 93

Useful Functions	94
Basic Procedure for Utility Operations	94
Backing Up User Data (Backup/Restore)	94
Backing Up to an SD Card (Backup)	94
Returning Backup Data to the FA (Restore)	94
Importing a Studio Set or Tone (Import Studio Set/Tone)	95
Importing from Backup Data	95
Importing Tones Downloaded from the Axial Site	95
Restoring the Factory Settings (Factory Reset)	95
Initializing an SD Card (Format SD Card)	96
Backing-Up SD Card Data to a Computer	96
Transmitting the Temporary Area's Data to an External MIDI Device (Bulk Dump)	96
Settings for the Entire FA	97
Basic Procedure for System Settings	97
Saving the System Settings	97
System Parameter	97
About the Wireless LAN Function	104
What is Wireless LAN Function?	104
Basic Connection Method (Connect by WPS)	104
Wireless LAN Function Settings	105
Status Indication (WIRELESS STATUS)	105
Connecting to a Wireless LAN Access Point That You Select (SELECT ACCESS POINT)	105
Other Settings (WIRELESS OPTIONS)	106
Checking the IP Address and MAC Address (WIRELESS INFORMATION)	106

10: Appendix 107

About SD Cards	108
Chord Memory List	109
Block Diagram	111
Error Message List	112
Troubleshooting	113
MIDI Implementation Chart	118
Main Specifications	120

01: Overview

Describes the top and rear panels of the FA, and the structure of its sound engine and memory.

Panel Descriptions	6
An Overview of the FA	10
Getting Ready	17

Panel Descriptions

Top Panel

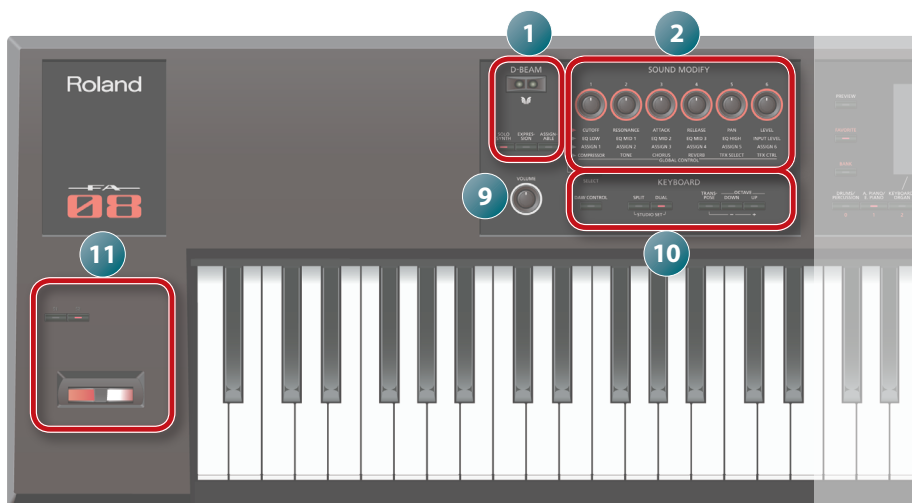

Number	Area	Name	Explanation	Page
1	D-BEAM	D-BEAM controller	By positioning your hand over the D-BEAM, you can apply various effects to the sound.	p. 41
		[SOLO SYNTH] button	Lets you play monophonic synthesizer sounds by moving your hand above the D-BEAM controller.	
		[EXPRESSION] button	Lets you use the D-BEAM controller to control the volume.	
		[ASSIGNABLE] button	Lets you assign various parameters of functions that modify the sound in real time.	
2	SOUND MODIFY	[1]–[6] knobs	Control the parameters that you've selected by the [SELECT] button.	p. 39
		[SELECT] button	Selects the group of parameters that is controlled by the [1]–[6] knobs.	
3		[PREVIEW] button	Auditions the currently selected tone while this button is held down.	p. 22
		[FAVORITE] button	Lets you register your favorite tones or studio sets to the [0]–[9] buttons.	p. 28
		FAVORITE [BANK] button		
		Tone buttons ([0]–[9])	Select tone category groups. If the [FAVORITE] button or [BANK] button is lit, these buttons operate as [0]–[9] buttons. When executing functions that are displayed at the bottom of the screen, these buttons operate as function buttons ([2]–[7] buttons).	p. 22
4	Display	Display	Shows various information depending on operation.	–
5		Dial	Changes a value. If you hold down the [SHIFT] button and turn the dial, the value changes more greatly.	–
		[MENU] button	Lets you make detailed settings for various functions.	–
		[WRITE] button	Saves a studio set, tone or song.	p. 45 p. 48 p. 74
		[DEC] [INC] buttons	Changes a value. If you press one of these buttons while holding down the other, the value changes more rapidly. If you press one of these buttons while holding down the [SHIFT] button, the value changes more greatly.	–
		[▲] [▼] [◀] [▶] buttons	Move the cursor position up/down/left/right.	–
		[SHIFT] button	Accesses the corresponding edit screen when pressed together with another button.	–
		[EXIT] button	Returns to the previous screen or closes the open window.	–
		[ENTER] button	Used to confirm a value, execute an operation, or view lists of tones or other items.	–

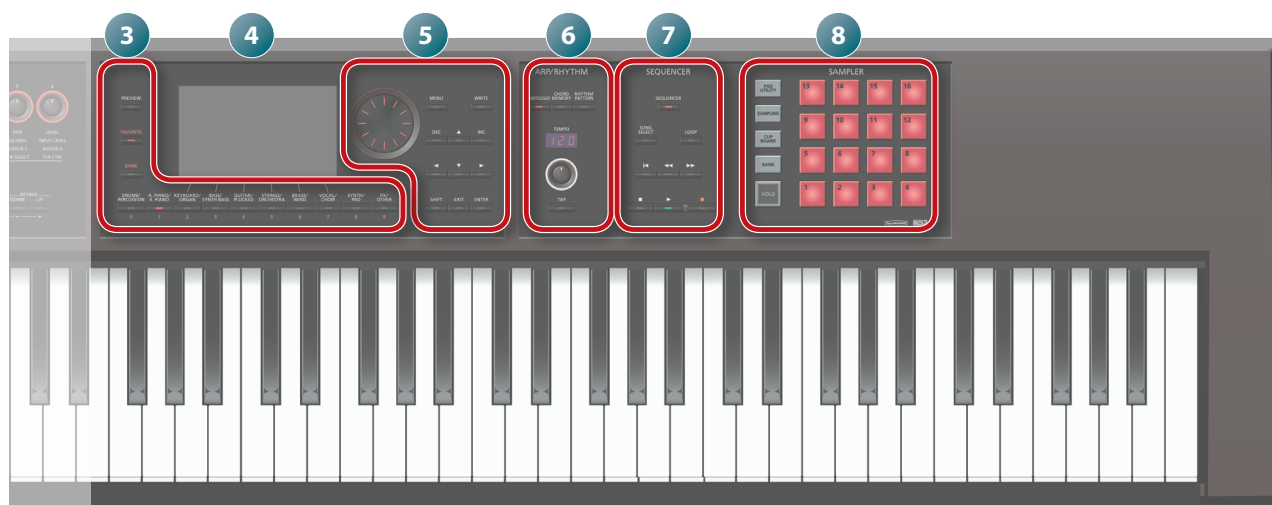

Number	Area	Name	Explanation	Page
6	ARP/RHYTHM	[ARPEGGIO] button	Turns the arpeggiator on/off.	p. 32
		[CHORD MEMORY] button	Turns the chord memory function on/off.	p. 35
		[RHYTHM PATTERN] button	Accesses the RHYTHM PATTERN screen.	p. 36
		TEMPO indicator	Indicates the tempo.	p. 37
		[TEMPO] knob	Adjusts the tempo.	
		[TAP] button	Sets the tempo to the interval at which you repeatedly press the button.	
7	SEQUENCER	[SEQUENCER] button	Accesses the SEQUENCER screen.	p. 58
		[SONG SELECT] button	Selects a song.	p. 56
		[LOOP] button	Loops the song playback or overdubbing.	p. 57
		[◀] button	Moves the song position to the beginning. If you press this button during playback, the position returns to the beginning of the song and playback stops.	p. 56
		[◀◀] [▶▶] buttons	Moves the song position to the first beat of the previous/next measure.	
		[■] button	Stops song playback or recording.	
		[▶] button	Plays the song.	p. 59
[●] button	Enters the record-standby state.			
8	SAMPLER	[PAD UTILITY] button	Displays the status of the samples, and lets you edit or import them. Functions other than the sampler can also be assigned.	p. 84
		[SAMPLING] button	Lets you sample.	p. 79
		[CLIP BOARD] button	Lets you move or copy a sample from one pad to another.	p. 80
		[BANK] button	Switches the pad bank.	p. 78
		[HOLD] button	Causes the sample to continue playing.	p. 78
		Pads [1]–[16]	Play the samples assigned to each pad.	p. 78
9		[VOLUME] knob	Adjusts the volume that is output from the MAIN OUTPUT jacks and the PHONES jack.	–
10	KEYBOARD	[DAW CONTROL] button	Lets you use this unit as a DAW controller.	p. 89
		[SPLIT] button	Turns the split function on/off.	p. 25
		[DUAL] button	Turns the dual function on/off.	p. 24
		[TRANSPOSE] button	Hold down this button and use the OCTAVE [DOWN] [UP] buttons to raise or lower the pitch range in semitone steps.	p. 29
		OCTAVE [DOWN] [UP] buttons	Raise or lower the pitch range in steps of an octave.	p. 29
11	Controller	[S1] [S2] buttons	Various parameters or functions can be assigned to these buttons. Hold down the [SHIFT] button and press one of these buttons to access a screen that lets you assign a function.	p. 41
		Pitch bend/modulation lever	Varies the pitch or applies vibrato.	

Overview

Performing

Performance Functions

Editing

Sequencer (Creating Songs)

Sampler

Pads

DAW

Settings

Appendix

Rear Panel (Connecting Your Equipment)

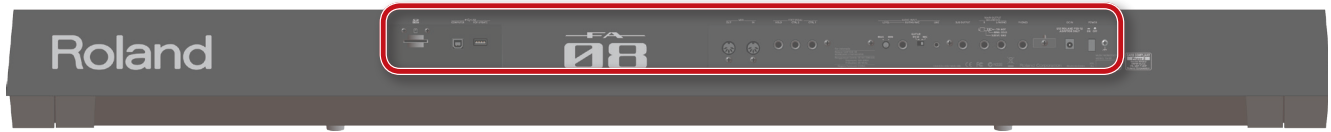

SD card slot

This unit is shipped from the factory with the included SD card inserted and the SD card protector secured with screws. To remove the SD card, remove the screws.

The SD card stores various data of this unit (e.g., settings, sounds, samples).



MIDI connectors

Connect an external MIDI device here.

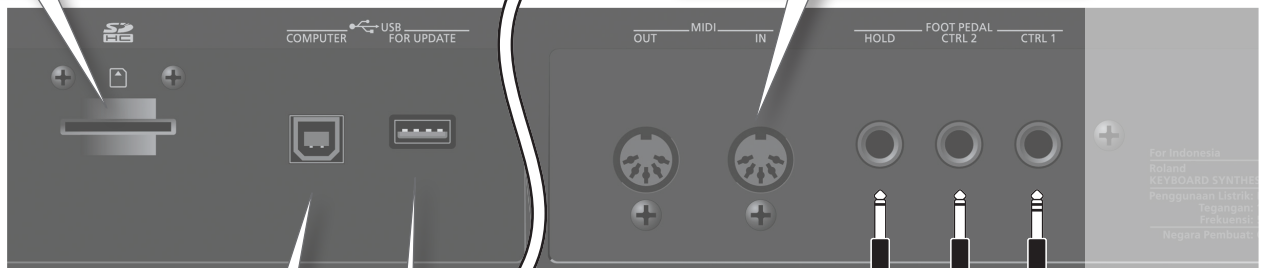

USB COMPUTER port

Use a commercially available USB 2.0 cable to connect this unit to your computer.



USB FOR UPDATE port

You can update the system program by connecting a USB flash drive here.

You can also connect a wireless USB adapter (WNA1100-RL; sold separately) here, and use wireless-enabled applications (such as the iPhone app Air Recorder).



* Use a commercially available USB flash drive or a USB flash drive sold by Roland. However, we cannot guarantee that all commercially available USB flash drives will work with this unit.

FOOT PEDAL jacks

HOLD jack

You can connect a pedal switch (DP series; sold separately) and use it as a hold pedal.



CTRL 1, CTRL 2 jacks

You can connect an expression pedal (EV-5; sold separately) or pedal switch (DP series; sold separately) here and use them to control various parameters or functions.

* Use only the specified expression pedal (EV-5; sold separately). By connecting any other expression pedals, you risk causing malfunction and/or damage to the unit.



* To prevent malfunction and equipment failure, always turn down the volume, and turn off all the units before making any connections.

* When connection cables with resistors are used, the volume level of equipment connected to the AUDIO INPUT jacks may be low. If this happens, use connection cables that do not contain resistors.

MAIN OUTPUT jacks

Connect your speakers here. If outputting in monaural, connect the L/MONO jack.

* This instrument is equipped with balanced (TRS) type jacks. Wiring diagrams for these jacks are shown below. Make connections after first checking the wiring diagrams of other equipment you intend to connect.



DC IN jack, Cord hook

Connect the included AC adaptor here.

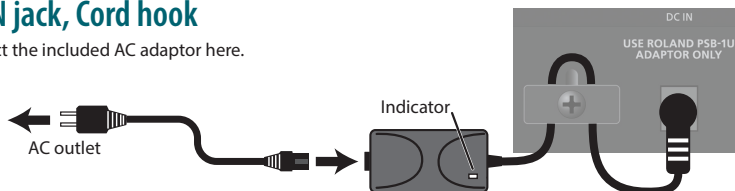

* To prevent the inadvertent disruption of power to your unit (should the plug be pulled out accidentally), and to avoid applying undue stress to the DC IN jack, anchor the power cord using the cord hook, as shown in the illustration.

* Place the AC adaptor so the side with the indicator (see illustration) faces upwards and the side with textual information faces downwards. The indicator will light when you plug the AC adaptor into an AC outlet.

[POWER] switch

Press this switch to turn it on/off.

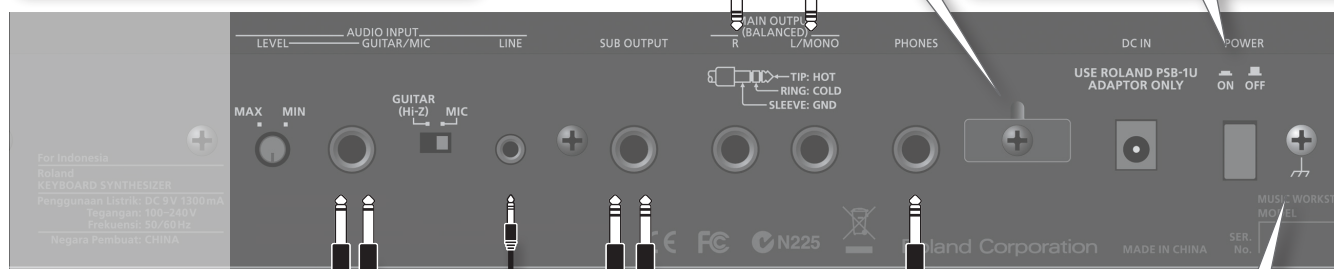

AUDIO INPUT jacks



GUITAR/MIC jack

Connect your guitar or microphone here.

Use the [LEVEL] knob to adjust the input level.

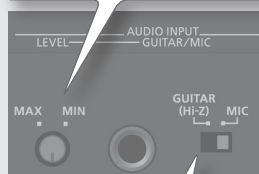

Set this to "GUITAR" if you've connected a guitar, or to "MIC" if you've connected a microphone.

MEMO

You can adjust the overall input volume (Audio Input Level: p. 80).

LINE jack

Connect your audio player or audio device here.

Use a stereo mini-plug cable (commercially available) to make connections. Adjust the volume using the controls of the device you've connected.



Ground terminal

Depending on the circumstances of a particular setup, you may experience a discomforting sensation, or perceive that the surface feels gritty to the touch when you touch this device, microphones connected to it, or the metal portions of other objects, such as guitars. This is due to an infinitesimal electrical charge, which is absolutely harmless. However, if you are concerned about this, connect the ground terminal (see figure) with an external ground. When the unit is grounded, a slight hum may occur, depending on the particulars of your installation. If you are unsure of the connection method, contact the nearest Roland Service Center, or an authorized Roland distributor, as listed on the "Information" page.

Unsuitable places for connection

- Water pipes (may result in shock or electrocution)
- Gas pipes (may result in fire or explosion)
- Telephone-line ground or lightning rod (may be dangerous in the event of lightning)

PHONES jack

Connect your headphones (sold separately) to this jack.



SUB OUTPUT jack

Connect separately sold headphones or speakers here. Sounds such as the metronome or a specific part can be specified for individual output.

Lets you synchronize your tempo with other players when performing in a band.

* The top panel [VOLUME] knob does not adjust the volume of this output.

An Overview of the FA

Overall Structure

Broadly speaking, the FA consists of three sections: **“synthesizer,” “sequencer,”** and **“sampler.”**

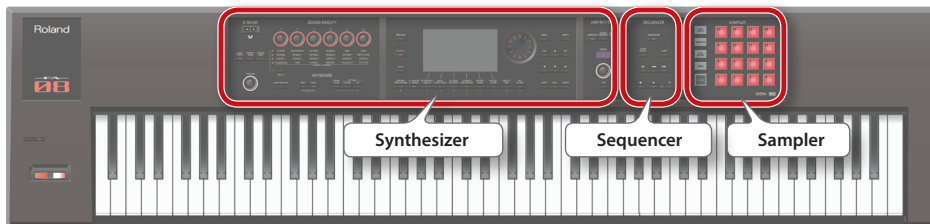

Synthesizer

page 21

The FA provides 16 parts, allowing you to play multiple tones simultaneously. These 16 parts are collectively called a **“studio set.”** One tone can be assigned to each part of a studio set.

Normally, you'll perform using the tone of part 1 (single play).

When using the sequencer to create a song, you'll use all 16 parts of the studio set (multi part play).

You can also use the tones of part 1 and part 2 for dual play or split play.

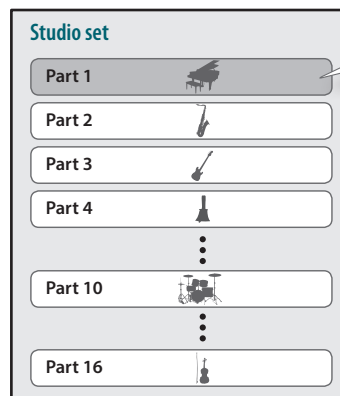

What is a tone?

Each sound that you can play on the FA is called a **“tone.”** Press a tone button to select a tone.

Sequencer

page 55

You can use the 16-track MIDI sequencer to create songs.

You can record 16 tracks using the tones of the studio set's 16 parts.

You can also record the performance data that is produced when you strike the pads to play samples.

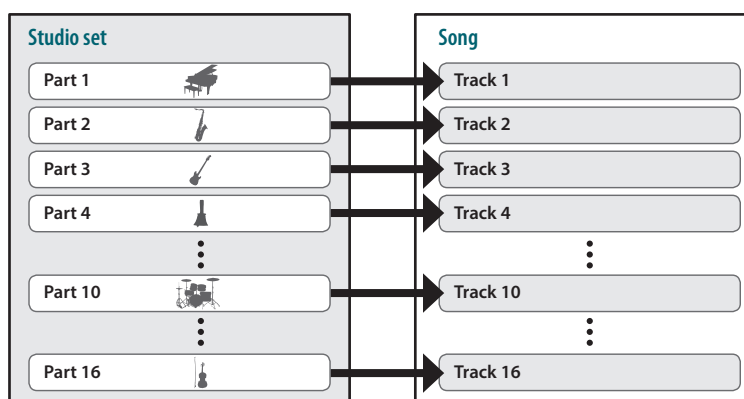

What is a song?

A **“song”** is performance data for one song. A song contains the performance data, tempo data, and the studio set that you used. Sample banks are also remembered for each song.

Sampler

page 77

Using the sampler section, the sound of your keyboard performance or the sound that's input from a connected audio device or microphone can be recorded (sampled) to an SD card as audio.

Samples that you've sampled to an SD card can be played by pressing the pads.

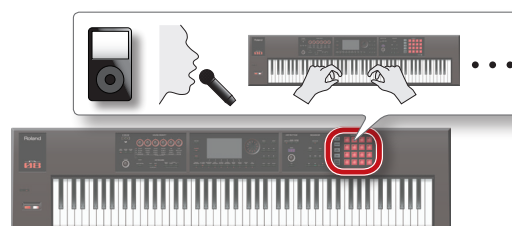

What is a sample?

A sample is a sampled sound together with loop data and other settings, that is assigned to one of the 16 pads.

How the Sound Engine Is Structured

Tones

There are two types of tones: **“SuperNATURAL tones”** and **“PCM tones.”**

You can choose a tone from the sound library and assign it to a part. You can also edit a tone and save it to user memory (p. 14).

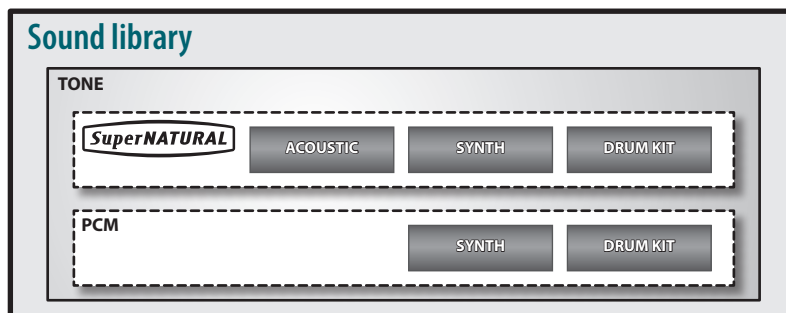

SuperNATURAL tones

There are three types of SuperNATURAL tones: **“SuperNATURAL acoustic tones,” “SuperNATURAL synth tones,”** and **“SuperNATURAL drum kits.”**

Type	Explanation
SuperNATURAL acoustic tones (SN-A)	These tones reproduce not merely the sounds of acoustic instruments, but also the differences arising from the phrase, chord, or melodic performances of the player, giving you the expressive power that is distinctive of that acoustic instrument.
SuperNATURAL synth tones (SN-S)	Each tone components: “OSC (oscillator),” “FILTER (filter),” and “AMP (amp).” Powerful synth sounds can be produced by a single tone.
SuperNATURAL drum kits (SN-D)	These are drum sounds that reproduce the natural tonal change from soft to strong strikes, and the way in which the sound responds to repeated strikes.

PCM Tones

There are two types of PCM tones: **“PCM synth tones”** and **“PCM drum kits.”**

Type	Explanation
PCM synth tones (PSMC)	These are sounds that were called “patches” on Roland synthesizers of the past, and have been tuned for this unit. You can combine up to four partials (waves) in one PCM synth tone.
PCM drum kits (PCMD)	These are sounds that were called “rhythm sets” on Roland synthesizers of the past, and have been tuned for this unit. A drum kit is a group containing multiple percussion instrument sounds so that different percussion instrument sound are heard depending on the key (note number) you play.

* Each tone built into the FA includes multi-effect (MFX) settings specifically for that tone.

Overview

Performing

Performance Functions

Editing

Sequencer (Creating Songs)

Sampler

Pads

DAW

Settings

Appendix

Studio Sets

A studio set contains 16 parts, with one tone assigned to each part.

Normally, you'll play the tone that's assigned to part one (single play). When using the sequencer to create a song, you'll use all 16 parts of the studio set (multi part play).

In a multi part play, you can assign a tone or drum kit to each part to create an ensemble, or layer sounds so that you can enjoy performing rich textures.

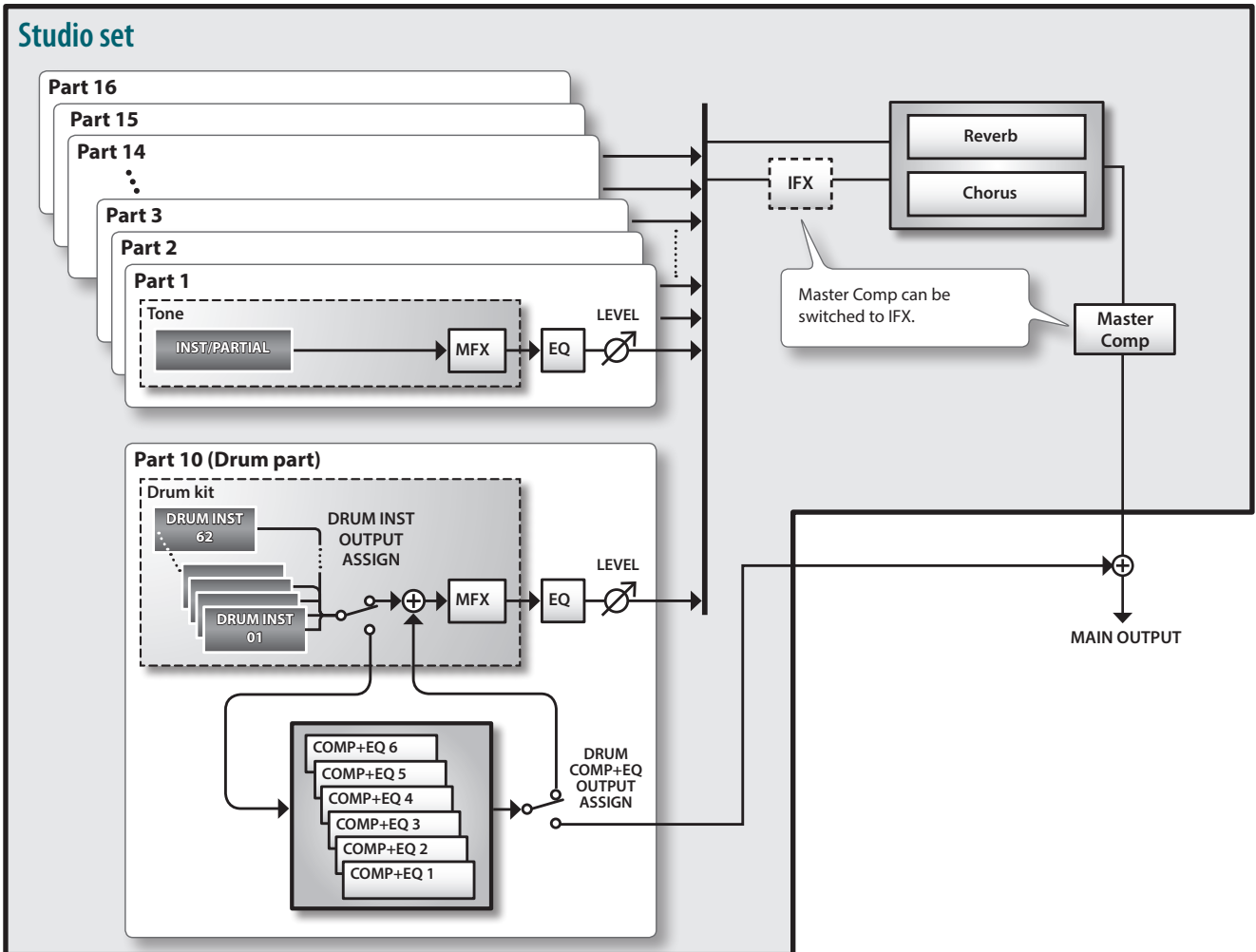

* As an example here, part 10 is assigned as a drum part.

About the Effects

The following effects are built into the FA, and you can make settings independently for each effect.

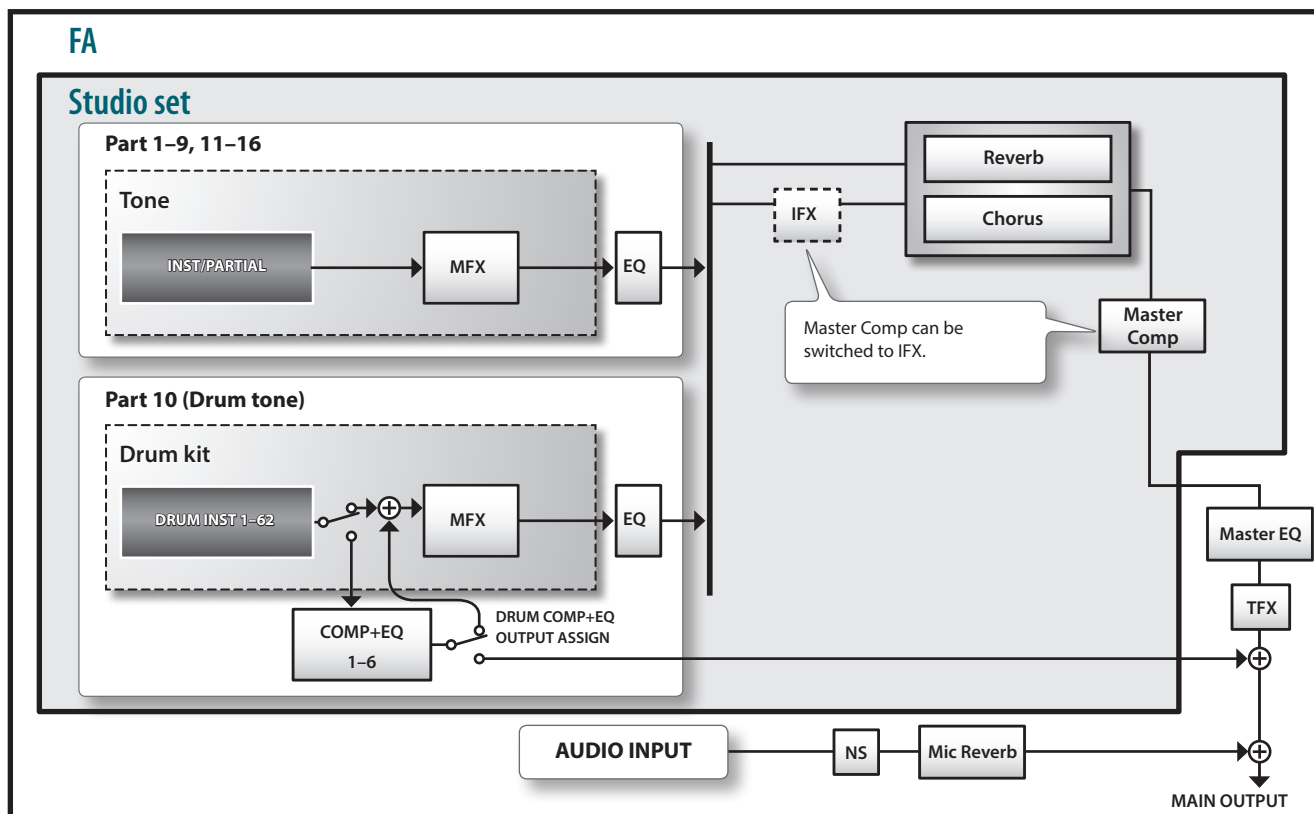

Effect type	Effect	Explanation
Tone effects	Multi-effect (MFX)	This is a general-purpose multi-effect that transforms the sound itself, giving it an entirely different character. You can choose from 68 types as appropriate for your needs. These types include single effects such as distortion or flanger, as well as a variety of other types. Each tone has settings for one multi-effect.
	Compressor + equalizer (COMP+EQ)	A drum part lets you use six compressors and equalizers. Each drum instrument can be individually assigned to these. Although a drum kit can be assigned to each of the parts, the six sets of compressor+equalizer are available only for one specified part (the part specified by the Drum Comp+EQ Assign setting).
Studio set effects	Equalizer (EQ)	This is an equalizer that can be applied to each part. You can independently adjust the high, mid, and low-frequency ranges.
	Chorus	Chorus is an effect that adds depth and spaciousness to the sound.
	Reverb	Reverb is an effect that produces the reverberation that is characteristic of sounds heard in a hall.
	Master compressor (Master Comp)	The compressor compresses sounds that exceed a specified volume level, making the volume more consistent. You can independently adjust the high, mid, and low-frequency ranges. * The insert effect is unavailable while the master effect is being used.
	Insert effect (IFX)	This is a general-purpose insert effect that can transform the sound itself, giving it a completely different character. You can choose from 78 types as appropriate for your needs. Use this when you want to apply an effect in addition to the multi-effect. * The master compressor is unavailable while the insert effect is being used.
System effects	Master EQ	This is an equalizer that is applied to the overall sound of the entire FA. You can independently adjust the high, mid, and low-frequency ranges.
	Total effect (TFX)	The total effect can be controlled in real time using the SOUND MODIFY knobs. You can choose from 29 types as appropriate for your needs. The total effect can also be applied to the sound being input from the AUDIO INPUT jack (p. 52).
Effects applied to the AUDIO INPUT jack	Noise suppressor (NS)	The noise suppressor is an effect that suppresses noise during periods of silence.
	Mic reverb	This is a reverb that is applied to the sound being input from the GUITAR/MIC jack.

MEMO

- For details on how to edit the effects, refer to **“Editing the Effects”** (p.52).
- For details on the effect parameters, refer to **“Parameter guide”** (PDF).

Overview

Performing

Performance Functions

Editing

Sequencer (Creating Songs)

Sampler

Pads

DAW

Settings

Appendix

About Memory

The area where studio sets, tones, and other settings are stored is called memory.

Memory can be classified into three types by its function: “**temporary memory (the temporary area)**,” “**rewritable memory (user memory, system memory, an SD card)**,” and “**non-rewritable memory (preset memory)**.”

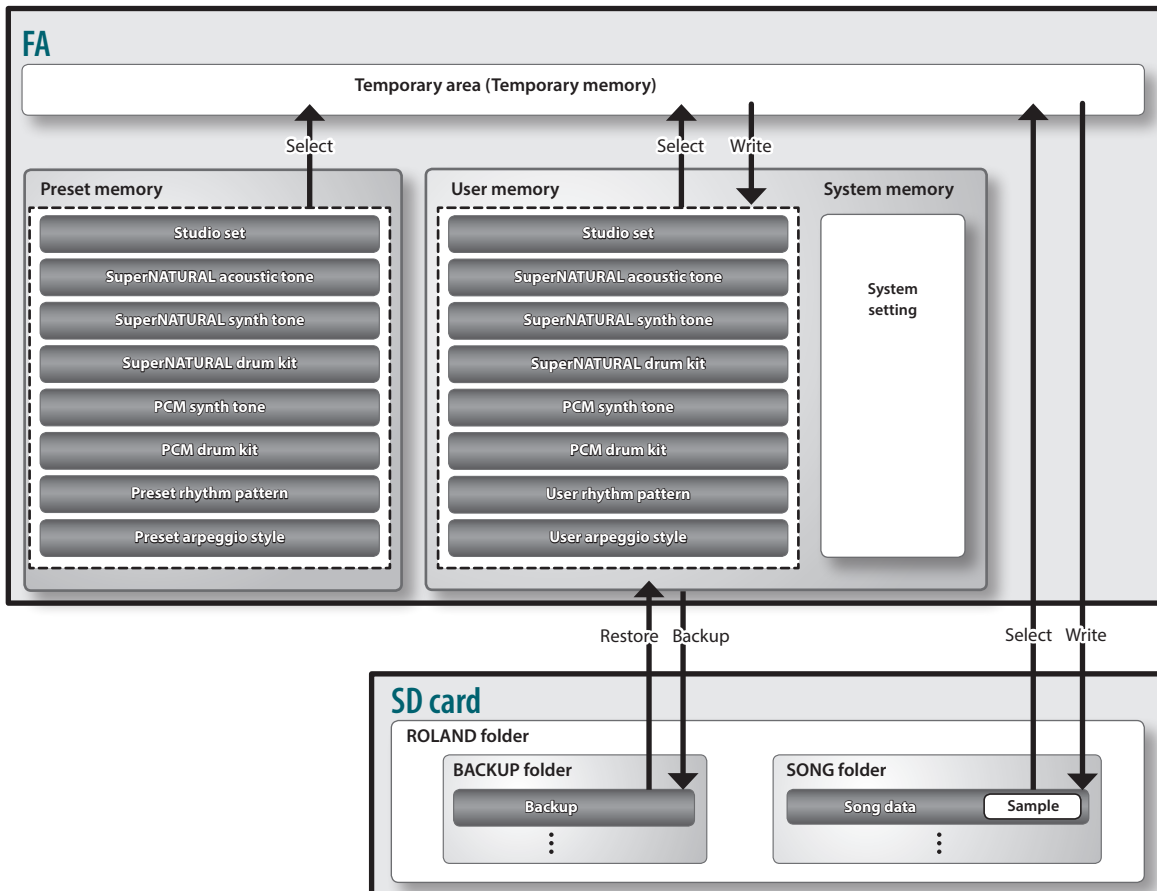

Temporary memory

The temporary area

This area temporarily holds the studio set, tones, and song data that you select using the panel buttons.

When you perform, the sounds are produced according to the settings in the temporary area. Likewise, when you edit a studio set, tone, or song, your edits are modifying the data that has been called into temporary memory; you are not directly modifying the data in the original memory.

Settings in temporary memory are not permanent; they will be lost when you turn off the power or recall other settings. If you want to keep the settings that are in temporary memory, you must save them to user memory or an SD card.

Rewritable memory

System memory

This area stores system settings for the entire FA. To save system parameters, execute the system save operation (p. 97).

User memory

Data that you save on the FA is held in this memory. To save data, execute the Save operation.

- Saving a studio set (p. 45)
- Saving a tone (p. 48)
- Saving a drum kit (p. 48)
- Saving a rhythm pattern (p. 51)
- Saving an arpeggio style (p. 45)

SD card

- The user memory data and the system parameter settings can be backed up together to an SD card (p. 94).
- Song data (including samples) is also saved on an SD card. To save a song, execute the Save operation (p. 74).
- Samples are automatically saved when you stop sampling or when you exit the SAMPLE EDIT screen.

Non-rewritable memory

Preset memory

Data in preset memory cannot be rewritten.

However, you can call this data into the temporary area, modify the settings, and then save those modified settings in user memory.

About the Sequencer

The sequencer is a function that records performance data from the keyboard and pads, allowing you to create a song.

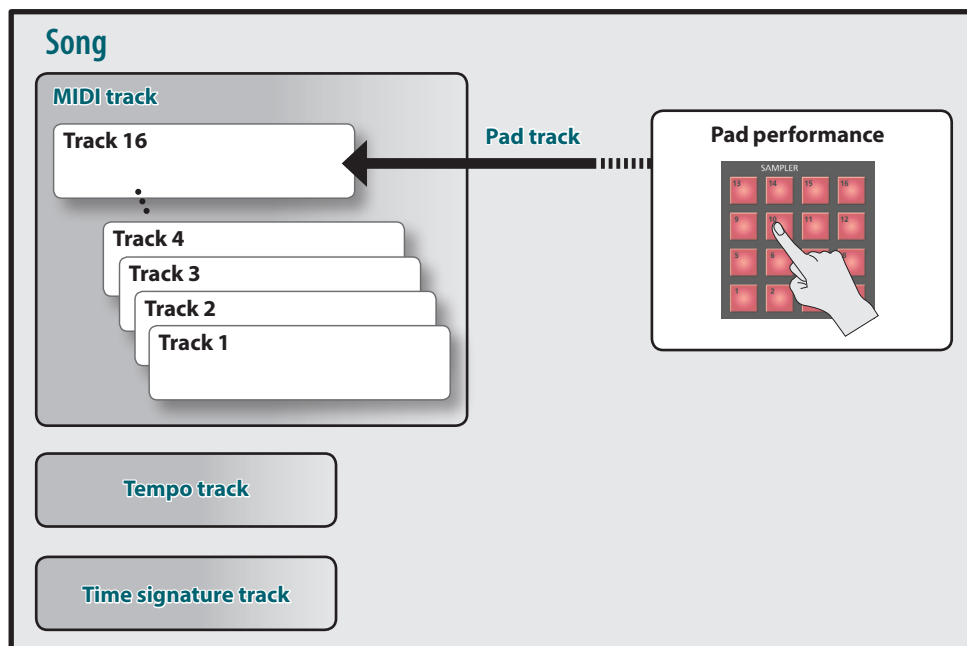

* You can use one of the tracks 1–16 as the pad track. As an example here, we've assigned track 16 to be the pad track.

Songs

Performance data for one song is called a song. This contains the data for tracks 1–16, the tempo track, the time signature track, and the samples (p. 10).

Tracks

A track is an area that records performance data.

Tracks 1–16

MIDI tracks (MIDI)

These tracks record keyboard performance data.

Pad track (PAD)

This track records performance data for the samples that you play by striking the pads. You can use one of the tracks 1–16 as the pad track.

Tempo track

The tempo track records changes in the song's tempo. Use it when you want the tempo to vary during the song.

Time signature track

The time signature track records the time signature of each measure in the song. You'll make settings for this track when you newly record a song, or when you want the time signature to change during the song.

About the Sampler

Your keyboard performance or the sound that's being input from an audio device or microphone can be sampled (recorded) by the sampler as audio data.

You can play back the sampled sounds by pressing the pads. You can also import WAV/AIFF/MP3 format files and use them as samples.

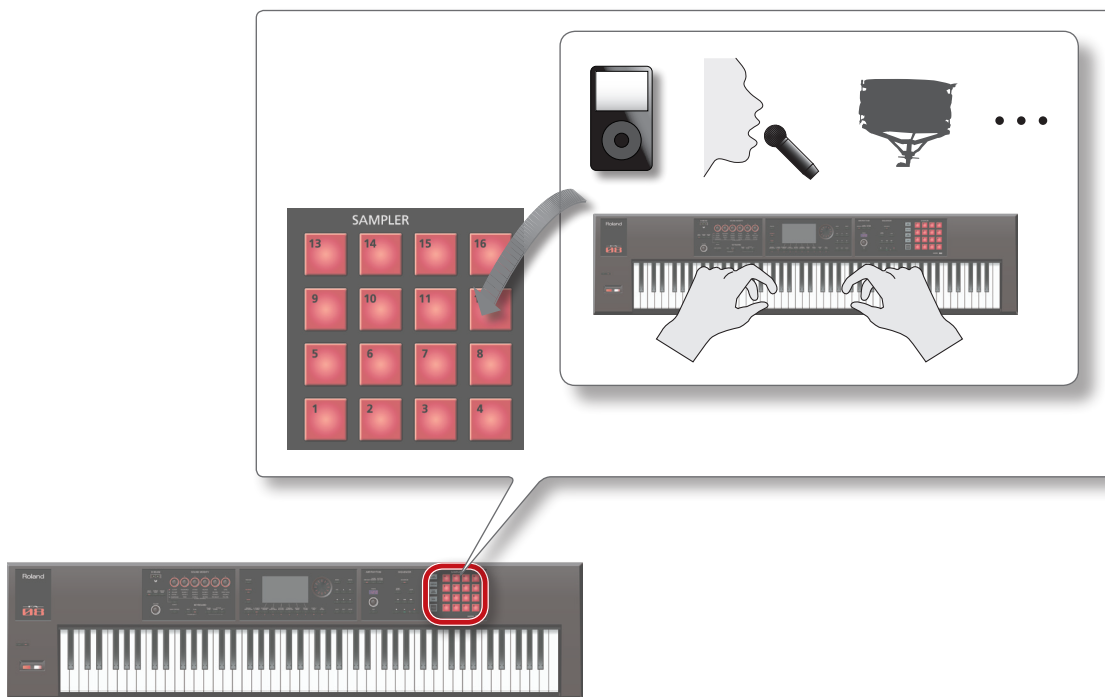

Samples

A “sample” is a sampled (recorded) sound together with loop settings and other data, that is assigned to one of the 16 pads.

By pressing pads [1]–[16] you can play the sample that is assigned to each pad.

MEMO

Samples are automatically saved to the song data on the SD card when you stop sampling or when you exit the SAMPLE EDIT screen.

Audio files that can be imported

WAV/AIFF	Sampling frequency	44.1/48/96 kHz
	Bit rate	8/16/24 bit
MP3	Format	MPEG-1 audio layer 3
	Sampling frequency	44.1 kHz
	Bit rate	64/80/96/112/128/160/192/224/256/320 kbps, VBR (Variable Bit Rate)

Getting Ready

Placing This Unit on a Stand

Be careful not to pinch your fingers when setting up the stand.

Place the instrument on the stand as follows.

- * When using the KS-18Z, ensure that the height of the unit is one meter or lower.

If you're using the FA-06/FA-07

If you want to place the FA-06/FA-07 on a stand, please use the KS-12 or KS-18Z stands manufactured by Roland.

- * The illustration shows the FA-06.

KS-12



Adjust the width of the stand so that the rubber feet on the keyboard side of the bottom of the keyboard fit into the rubber feet receptacles

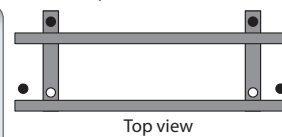

KS-18Z

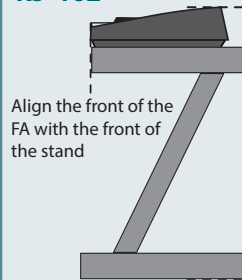

Adjust so that the height does not exceed 1 meter (Adjust the stand to a level no higher than the fifth level from the bottom)

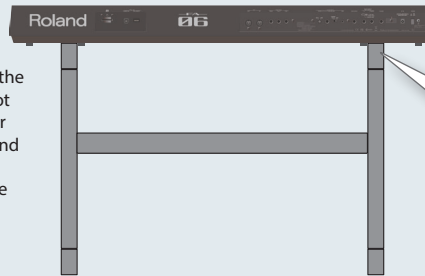

Adjust the width of the stand so that the rubber feet of the FA straddle the stand

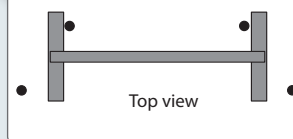

If you're using the FA-08

If you want to place the FA-08 on a stand, please use the KS-12, KS-18Z, or KS-G8B stands manufactured by Roland.

KS-12

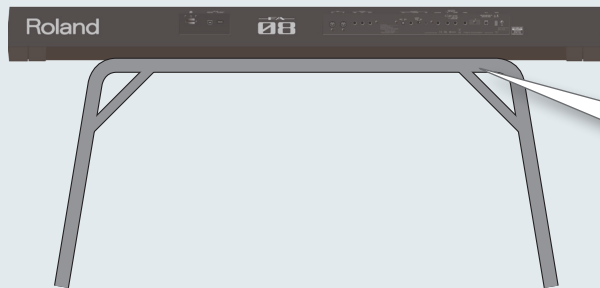

Adjust the width of the stand so that the rubber feet of the FA fit into the rubber feet receptacles



Top view

KS-18Z

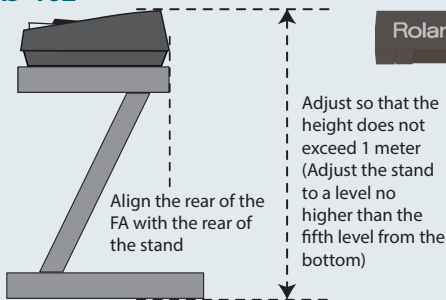

Align the rear of the FA with the rear of the stand

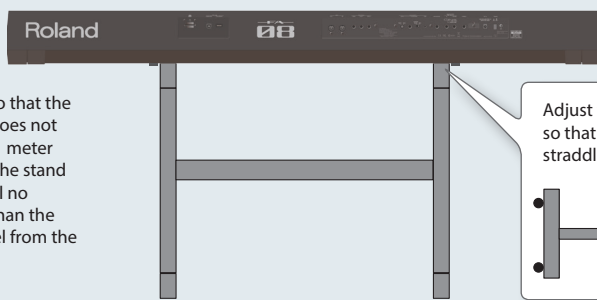

Adjust the width of the stand so that the rubber feet of the FA straddle the stand

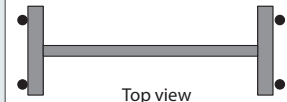

Top view

KS-G8B

Align the front of the FA with the rubber base of the stand

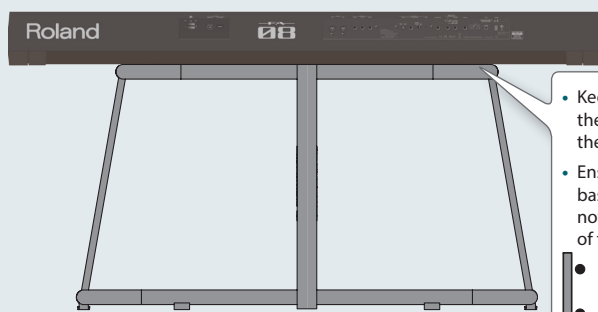
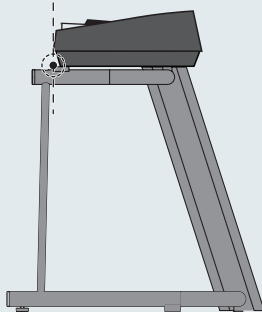

- Keep the rubber feet of the FA on the inside of the stand
- Ensure that the rubber base of the stand does not contact the screws of the FA



Top view

Turning the Power On/Off

Once everything is properly connected (p. 8), be sure to follow the procedure below to turn on their power. If you turn on equipment in the wrong order, you risk causing malfunction or equipment failure.

Turning the Power On

* Before turning the unit on/off, always be sure to turn the volume down. Even with the volume turned down, you might hear some sound when switching the unit on/off. However, this is normal and does not indicate a malfunction.

1. Turn the power on in the following order: the FA → connected devices.

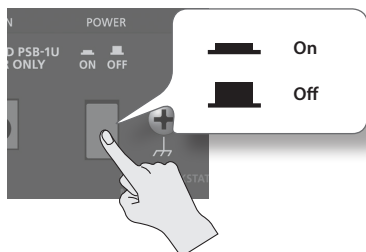

2. Turn the [VOLUME] knob to adjust the volume.



Concerning the Auto Off function

The power to this unit will be turned off automatically after a predetermined amount of time has passed since it was last used for playing music, or its buttons or controls were operated (Auto Off function). If you do not want the power to be turned off automatically, disengage the Auto Off function.

- Any settings that you are in the process of editing will be lost when the power is turned off. If you have any settings that you want to keep, you should save them beforehand.
- To restore power, turn the power on again.

Turning the Power Off

1. Turn the power off in the following order: connected devices → the FA.

Playing the Demo Songs

The SD card included with this unit contains demo songs.

1. Press the [▶] button.

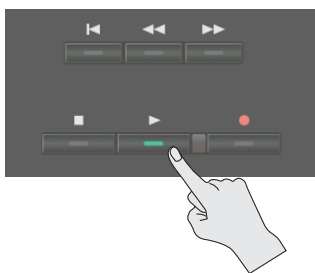

Demo song playback starts.

2. Press the [■] button to stop.

* Use of the demo songs for any purpose other than personal enjoyment without permission from the copyright holder is prohibited by law.

Selecting a song

1. Press the [SONG SELECT] button.
The SONG SELECT screen appears.
2. Turn the dial to select a song.
3. Press the [7] (Load) button.
A confirmation message appears.
4. Press the [6] (OK) button.
The song is selected.

02: Performing

Explains basic performance operations, such as how to select tones.

Playing One Tone (Single Play)	22
Playing Two Tones Together (Dual)	24
Playing Different Tones in the Right and Left Hands (Split)...	25
Playing Multiple Parts (Multi Part Play).....	26
Registering/Recalling Favorite Sounds (Favorites)	28
Changing the Keyboard Settings	29

Playing One Tone (Single Play)

When playing the FA, you'll typically play the tone that's assigned to part 1 of the studio set (single play mode).

The tones are organized into the following banks.

Bank	Explanation
PRST (preset)	These are non-rewritable tones, but you can edit a tone and save the edited result in the user bank.
USER (user)	Tones you edit can be saved in this bank.

MEMO

For PCM synth tones and PCM drum kits, you can also select from the GM2 bank.

Selecting a Tone

1. Make sure that the **[SPLIT]** button and **[DUAL]** button are unlit.
2. Press a tone button to select a category group.

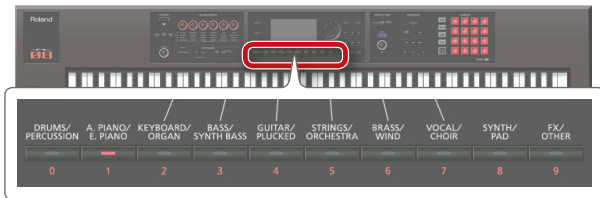

Category group	Explanation
DRUMS/PERCUSSION	Rhythm instruments
A. PIANO/E. PIANO	Piano
KEYBOARD/ORGAN	Keyboard/organ
BASS/SYNTH BASS	Bass
GUITAR/PLUCKED	Guitar
STRINGS/ORCHESTRA	Strings/orchestral
BRASS/WIND	Brass/woodwinds
VOCAL/CHOIR	Vocal/choir
SYNTH/PAD	Synthesizer/pads
FX/OTHER	Sound effects/other

3. Press a tone button.

MEMO

If you press a tone button twice in succession, a different category in the same category group is selected.

4. Turn the dial to select a tone.

Play the keyboard and hear the sound.

MEMO

- For more about tones, refer to **"Sound List"** (PDF).
- If you hold down the **[PREVIEW]** button, the FA plays a demo using a phrase that's suitable for the selected tone.
- If you hold down the **[SHIFT]** button and press the **[PREVIEW]** button, the phrase continues playing and the **[PREVIEW]** button remains lit even after you release it. When you press the **[PREVIEW]** button once again, the button goes dark and the phrase playback stops.
- If desired, you can make the SOUND MODIFY knob settings be reset when you switch tones (Auto Knob Reset: p. 99).

About the screen



No.	Explanation	Page
1	Effect information and status	p. 52
2	Song information	p. 56
3	Bank, number, and name of the studio set	p. 27
4	Tone number and name	-
5	Type and bank of tone	p. 11
6	Tone level	p. 44
7	Category name and lock	-
8	Keyboard status (active region, dual, split, etc.)	p. 44

Save your selection

Your selection of tone is temporary. If you turn off the power or choose a different studio set, your tone selection disappears. If you want this unit to remember the tone you selected, save the studio set (p. 45).

Selecting tones by category (Category Lock)

If you move the cursor to the lock icon (🔒) and use the dial or the **[DEC]** **[INC]** buttons to select the **"UNLOCK"** setting, you can select tones across categories.

If the **"LOCK"** setting is selected, tones can be selected within the currently selected category.

You can add tones

A wide range of tones from the Axial sound library site can be added to the FA.

For details, refer to the Axial site

<http://axial.roland.com/>



Selecting a Tone from a List

You can view a list of tones and select one of them.

1. Make sure that the **[SPLIT]** button and **[DUAL]** button are unlit.
2. Press a tone button to select a category group.
3. Press the **[ENTER]** button.

The TONE LIST screen appears.

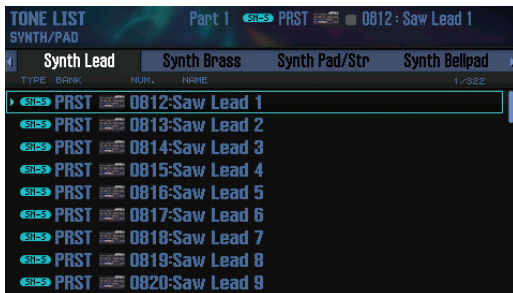

MEMO

You can also access the TONE LIST screen by moving the cursor to the tone and pressing the **[ENTER]** button.

4. Use the cursor [**◀**] [**▶**] buttons to select a category.
5. Use the dial or the **[DEC]** **[INC]** buttons to select a tone, and press the **[ENTER]** button.

MEMO

For more about the tones, refer to **“Sound List”** (PDF).

Playing Two Tones Together (Dual)

You can layer two tones so that they are played simultaneously by the same key. This is called Dual performance mode.

In Dual mode, you'll hear the tones of part 1 and part 2 of the studio set.

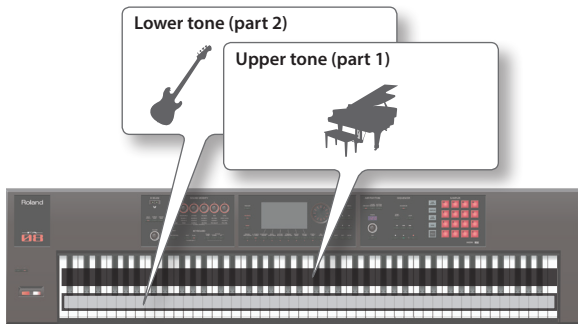

1. Press the **[DUAL]** button to make it light.

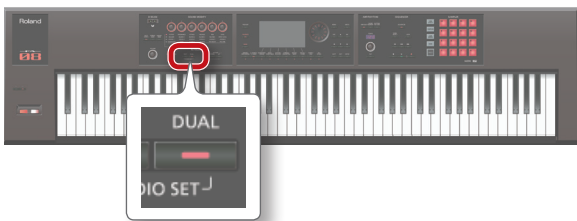

The Dual screen appears. The upper tone and lower tone are heard as a layer.



2. To cancel Dual mode, press the **[DUAL]** button to make it go dark.

Changing the Tones

Here's how to change the tones that you're playing in Dual mode.

1. Access the Dual screen.
2. Move the cursor to the tone of the part that you want to change, and use the dial or the **[DEC]** **[INC]** buttons to change the tone.

MEMO

- You can also select a tone by pressing a tone button.
- When you're playing in Single mode or in Dual mode, you can select two tones by simultaneously pressing two of the tone buttons.
- If you want the Dual settings to be memorized, save the studio set (p. 45).

Playing Different Tones in the Right and Left Hands (Split)

You can divide the keyboard so that the right-hand and left-hand regions each play a different tone.

This is called Split performance mode, and the location at which the keyboard is split is called the “split point.”

In Split mode, you'll hear the tones of part 1 and part 2 of the studio set.

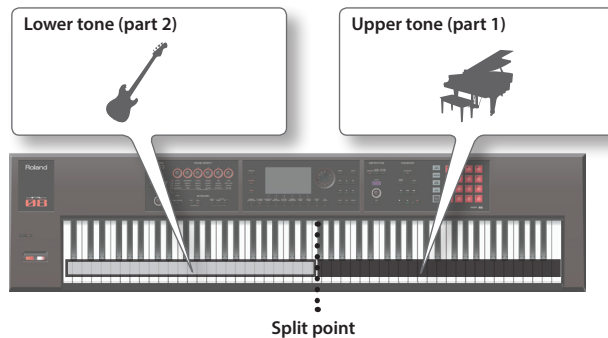

1. Press the [SPLIT] button to make it light.

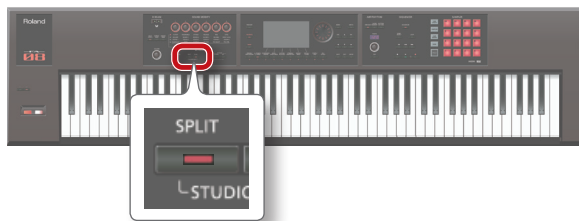

The Split screen appears. The right-hand region of the keyboard plays the upper tone, and the left-hand region plays the lower tone.

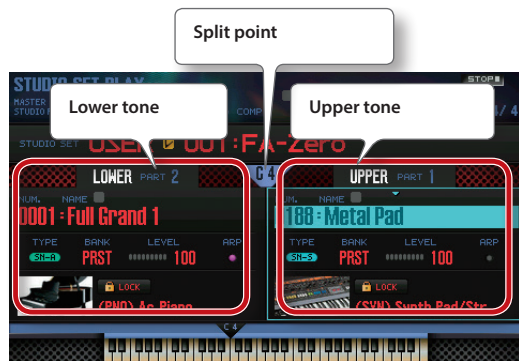

2. To cancel Split mode, press the [SPLIT] button to make it go dark.

Changing the Tones

Here's how to change the tones that you're playing in Split mode.

1. Access the Split screen.
2. Move the cursor to the tone of the part that you want to change, and use the dial or the [DEC] [INC] buttons to change the tone.

MEMO

You can also select a tone by pressing a tone button.

Changing the Split Point

Here's how to change the split point.

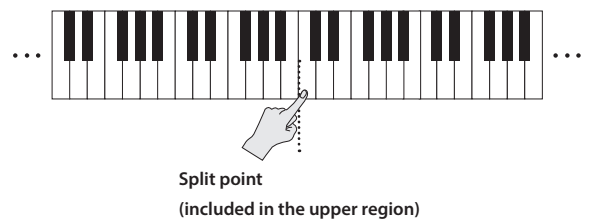

1. Hold down the [SPLIT] button and press the key that you want to assign as the new split point.

The key you press becomes the new split point.

MEMO

- You can also assign the split point in the following ways.
- In the Split screen, move the cursor to the split point and turn the dial.
- With the cursor located at the split point, hold down the [SHIFT] button and press the key that you want to assign as the split point.
- If you want the Split settings to be memorized, save the studio set (p. 45).

Playing Multiple Parts (Multi Part Play)

If you want to perform using three or more parts in a complex combination, or if you're using the sequencer to create a song, you'll use all 16 parts of the studio set (multi part play).

1. Press the **[SPLIT]** button and **[DUAL]** button simultaneously.

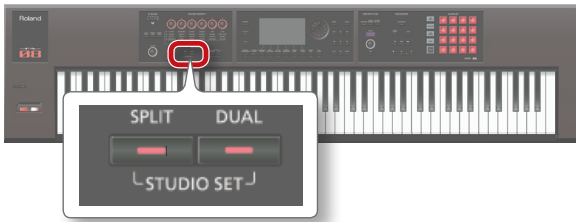

The **[SPLIT]** button and **[DUAL]** button are both lit, and the FA is in multi part play mode.

If you press the **[SPLIT]** button and **[DUAL]** button simultaneously once again, you return to single play mode.

Viewing the Part Settings (PART VIEW Screen)

In the PART VIEW screen you can view or edit a list of the part settings.

1. Press the **[MENU]** button.
2. Move the cursor to "Part View" and press the **[ENTER]** button.

The PART VIEW screen appears.



MEMO

You can also access the PART VIEW screen from the STUDIO SET PLAY screen by holding down the **[SHIFT]** button and pressing the **[4] (Part View)** button.

3. Use the cursor buttons to select a parameter, and use the dial to edit the value.

You can switch tabs by holding down the **[SHIFT]** button and using the cursor **[◀] [▶]** buttons.

MEMO

For more about the part parameters, refer to "Parameter Guide" (PDF).

About the screen

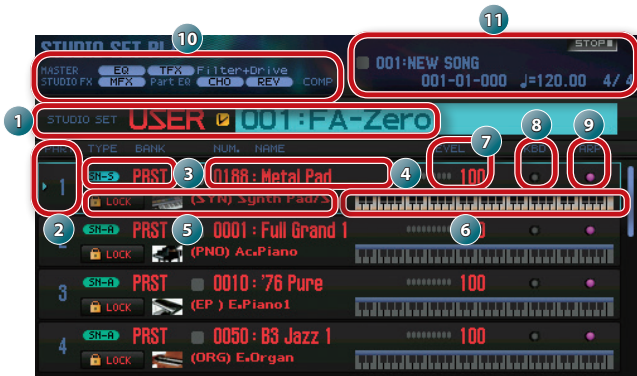

No.	Explanation	Page
1	Bank, number, and name of the studio set	p. 27
2	Part number	-
3	Type and bank of tone	p. 11
4	Tone number and name	-
5	Category name and lock	-
6	Keyboard status (key range, etc.)	p. 44
7	Tone level	p. 44
8	Keyboard switch setting	p. 27
9	Arpeggio switch setting	p. 32
10	Effect information and status	p. 52
11	Song information	p. 56

MEMO

- To edit a setting, move the cursor to that value and turn the dial. If you want to keep the edited settings, save the studio set in the user bank (p. 45).
- To change the keyboard range, move the cursor to the keyboard (6) and turn the dial, or press a key while holding down the **[SHIFT]** button.
- To view all parts simultaneously, hold down the **[SHIFT]** button and press the **[7] (◼◄◻)** button.

Selecting the Parts that Sound (Keyboard Switch)

Here's how to select the parts that are heard when you play the keyboard.

1. Put the FA in multi part play mode (p. 26).
2. Move the cursor to the "KBD" field of the part whose keyboard switch setting you want to change, and use the dial or the [DEC] [INC] buttons to turn it on/off.



When you play the keyboard, you hear parts whose keyboard switch is turned on.

MEMO

- If you want to play multiple parts as a layer, turn on the keyboard switch of those parts. Also, ensure that one of the parts whose keyboard switch is on is the current part (the currently selected part).
- If a part whose keyboard switch is turned off becomes the current part, you can play just the sound of that part by itself.
- The current part is memorized in the studio set.
- You can use the pads to turn the keyboard switch on/off (p. 85).

Switching Studio Sets

Here's how to switch between studio sets. There are two banks of studio sets, as follows.

Bank	Explanation
PRST (preset)	Non-rewritable studio sets. You can edit a studio set and save the edited result in the user bank.
USER (user)	Studio sets you edit can be saved in this bank.

1. Move the cursor to "STUDIO SET," and use the dial or the [DEC] [INC] buttons to select a studio set.



MEMO

You can move the cursor to "STUDIO SET" and press the [ENTER] button to access the STUDIO SET LIST screen. You can also select a studio set from the list.

Registering/Recalling Favorite Sounds (Favorites)

If there are sounds that you use frequently in live performance, you can register them as “favorites” for instant recall.

You can register ten sounds in each bank; ten such banks (0–9) can be created.

For example, sounds for the songs you play in a live performance could be registered in the order in which you’ll play them.

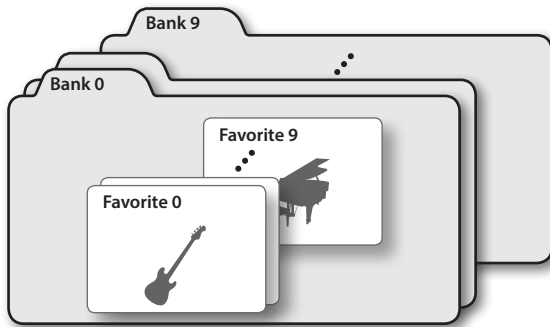

Registering a Sound as a Favorite

Here’s how to register a sound as a favorite.

1. Select the sound (tones or studio sets) that you want to register.
2. Press the **[FAVORITE]** button to make it light.



3. Select the bank in which you want to register the favorite.



1. Press the **FAVORITE [BANK]** button.
2. Press a button (**[0]–[9]** button) to specify the bank number.
4. Hold down the **[FAVORITE]** button and press a button (**[0]–[9]** buttons) to specify the number in which the favorite will be stored.

The sound has been registered.

MEMO

The content that is registered as a favorite will depend on the performance state.

Performance state	Registered content
Single play	The tone of part 1 * The Octave Shift (p. 44) setting of part 1 is recalled as “0.”
Dual play	
Split play	The studio set
Multi part play	

Recalling a Favorite

If you leave the **[FAVORITE]** button turned on, you can successively recall favorites simply by pressing the **[0]–[9]** buttons.

1. Press the **[FAVORITE]** button to make it light.
Now you can use the **[0]–[9]** buttons to recall favorites.
2. Select the bank you want to recall.
 1. Press the **FAVORITE [BANK]** button.
 2. Press the button (**[0]–[9]** buttons) of the bank number that you want to select.

MEMO

You can change the favorite bank even when the **[FAVORITE]** button is off.

3. Use the **[0]–[9]** buttons to select a favorite.
The favorite will be recalled.

Registering/Recalling/Editing Favorites in the List

Regardless of whether the **[FAVORITE]** button is on or off, you can view a list of the registered favorites, and register or recall favorites. You can also remove a registered favorite, or change its number.

1. Hold down the **[SHIFT]** button and press the **[FAVORITE]** button.

The FAVORITE LIST screen appears.

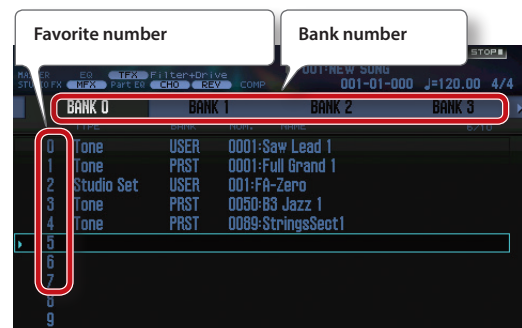

2. Use the cursor **[◀][▶]** buttons to choose the bank.
3. Use the cursor **[▲][▼]** buttons or the **[DEC][INC]** buttons to choose a favorite.

Button	Explanation
[ENTER] button or [7] (Select) button	Recalls the selected favorite.
Hold down the [SHIFT] button and press the [2] (Remove) button	Removes the selected favorite.
Hold down the [SHIFT] button and press the [3] (Regist) button	Registers the currently selected sound at the selected favorite number. If a favorite is already registered at the selected number, it is replaced by the newly registered content.
Hold down the [SHIFT] button and use the [▲][▼] buttons	Changes the registered number. If a favorite is already registered in the destination number, the selected favorite is inserted at the destination number.

Changing the Keyboard Settings

Raising/Lowering the Key Range in Semitone Steps (Transpose)

You can transpose the pitch range of the keyboard in semitone steps.

1. Hold down the **[TRANPOSE]** button and press the **[-]** button or **[+]** button.



MEMO

- You can transpose in a range of -5–+6 semitones.
- To return to the original setting, hold down the **[TRANPOSE]** button, and press the **[-]** button and **[+]** button simultaneously.

Raising/Lowering the Key Range in Octaves (Octave Shift)

You can shift the pitch range of the keyboard in steps of one octave.

1. Press the **OCTAVE [DOWN]** button or **[UP]** button.



MEMO

- You can shift the pitch in a maximum range of ± 3 octaves.
- To return to the original range, press the **OCTAVE [DOWN]** button and **[UP]** button simultaneously.

03: Performance Functions

Explains convenient functions that you'll use while performing, such as modifying the sound in real time.

Playing Arpeggios	32
Using Chord Memory	35
Performing with Rhythm Patterns	36
Modifying the Sound in Real Time	39

Playing Arpeggios

Using the Arpeggiator

The FA has an arpeggiator that can automatically generate arpeggios. When you use this function, an arpeggio is automatically played according to the keys that you hold down.

MEMO

Arpeggio settings are saved in the studio set.

1. Press the [ARPEGGIO] button to make it light.



The arpeggiator turns on.

MEMO

If the FA is not in single play mode, make settings as follows depending on the mode that you're in.

Performance state	Action
Dual play	Turn on the arpeggio switch (ARP in the Dual screen or Split screen) for the part that you want to arpeggiate.
Split play	
Multi part play	<ul style="list-style-type: none">• Turn on the arpeggio switch (ARP) for the part that you want to arpeggiate. For details, refer to "Parameter Guide" (PDF).• Make the current part any part whose keyboard switch (p. 27) is on.

2. Play a chord on the keyboard.

An arpeggio is sounded by the part that is turned on, according to the notes of the chord that you play.

3. To turn off the arpeggiator, press the [ARPEGGIO] button once again to make the button go dark.

MEMO

By using the arpeggiator in conjunction with the chord memory function (p. 35), you can easily produce a variety of arpeggio sounds using just one finger.

Setting the Arpeggiator Tempo

You can set the tempo of the arpeggios.

1. Turn the [TEMPO] knob.



MEMO

- The tempo is saved in the studio set. If you set this to follow the system tempo, the tempo will be maintained even if you switch studio sets (Tempo Assign Source: p. 101).
- You can set the tempo by pressing the [TAP] button at the desired interval ("tap tempo"). Press the button at least three times, at quarter-note intervals of the desired tempo.
- When you press the [TAP] button, the Tempo window appears. In this state, you can hold down the [SHIFT] button and turn the dial to adjust the value below the decimal point. If you press the [6] (Click) button, a click is sounded at the specified tempo. The click turns on/off each time you press the button.

Holding the Arpeggio (Hold)

Here's how to make the arpeggio continue sounding even after you release the keyboard.

1. Press the [ARPEGGIO] button.

The ARPEGGIO screen appears.

2. Press the [2] (Hold) button.

The hold function turns on.

3. Play a chord on the keyboard.

An arpeggio begins playing on the part for which the arpeggiator is turned on.

If you play a different chord or key while the arpeggio is being held, the arpeggio also changes.

4. To turn off the hold function, press the [2] (Hold) button once again.

The hold function turns off.

Using a pedal switch

If you hold down a pedal switch (p. 42) while playing a chord, the arpeggio continues playing even if you release the keyboard.



1. Connect your pedal switch (e.g., DP series; sold separately) to the HOLD jack.

2. Press the [ARPEGGIO] button.

3. Play a chord while holding down the pedal switch.



If you play a different chord or key while the arpeggio is being held, the arpeggio also changes.

Arpeggiator Settings

You can make detailed settings for the arpeggio's performance style, timing, and accent.

1. Press the [ARPEGGIO] button.
The ARPEGGIO screen appears.
2. Use the cursor buttons to select a parameter, and use the dial to edit the value.

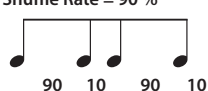
Parameter	Value	Explanation
Style	P001–P128, U001–U016	Specifies the basic way in which the arpeggio will be played. MEMO You can create your own original Arpeggio Style by importing SMF into an arpeggio user style. For details, refer to "Importing a Computer SMF File into an Arpeggio Style (Import SMF)" (p.34).
Hold	OFF, ON	Turn the hold function on/off (p. 42).
Variation	1–	The arpeggiator provides several variations (performance patterns) for each arpeggio style. This parameter selects the variation number. The number of variations will differ according to the arpeggio style.
Motif		Sets the order in which notes of the chord will sound.
	UP	Notes you press will be sounded, from low to high.
	DOWN	Notes you press will be sounded, from high to low.
	UP&DOWN	Notes you press will be sounded, from low to high, and then back down from high to low.
	RANDOM	Notes you press will be sounded, in random order.
	NOTE_ORDER	Notes you press will be sounded in the order in which you pressed them. By pressing the notes in the appropriate order you can produce melody lines. Up to 128 notes will be remembered.
	GLISSANDO	Each chromatic step between the highest and lowest notes you press will sound in succession, repeating upward and downward. Press only the lowest and the highest notes.
	CHORD	All notes you press will sound simultaneously.
	AUTO1	The timing at which keys will sound will be assigned automatically, giving priority to the lowest key that was pressed.
AUTO2	The timing at which keys will sound will be assigned automatically, giving priority to the highest key that was pressed.	
PHRASE	Pressing a single key will sound the phrase based on the pitch of that key. If multiple keys are pressed, the last-pressed key will be valid.	
Keyboard Velocity	REAL, 1–127	Specifies the loudness of the notes that you play. If you want the velocity value of each note to depend on how strongly you play the keyboard, set this parameter to "REAL." If you want each note to have a fixed velocity regardless of how strongly you play the keyboard, set this parameter to the desired value (1–127).

Parameter	Value	Explanation
Octave Range	-3+3	Sets the key range in octaves over which arpeggio will take place. If you want the arpeggio to sound using only the notes that you actually play, set this parameter to "0." To have the arpeggio sound using the notes you play and notes 1 octave higher, set this parameter to "+1." A setting of "-1" will make the arpeggio sound using the notes you play and notes 1 octave lower.
Accent Rate	0–100 %	Modifies the strength of accents and the length of the notes to adjust the "groove" feel of the arpeggio. A setting of "100 %" will produce the most pronounced groove feel.
Shuffle Rate	0–100 %	This setting lets you modify the note timing to create shuffle rhythms. With a setting of "50 %" the notes will be spaced evenly. As the value is increased, the note timing will have more of a "dotted" (shuffle) feel. <div style="text-align: center;"> <p>Shuffle Rate = 50 %</p>  <p>Shuffle Rate = 90 %</p>  </div>
Shuffle Resolution		Specifies the timing (as a note value) at which the notes will be heard. The note value can be specified as either a sixteenth note or an eighth note.

Overview

Performing

Performance Functions

Editing

Sequencer (Creating Songs)

Sampler

Pads

DAW

Settings

Appendix

Importing a Computer SMF File into an Arpeggio Style (Import SMF)

You can create an original arpeggio style by importing an SMF (Standard MIDI File).

SMF that can be imported

- Only SMF format 0 is supported. If the data is incorrect, a message of **“Cannot Import SMF Format 1!”** or **“Incorrect File!”** appears.
- The following data can be imported into an arpeggio: note data, control change data, channel pressure, and pitch bend change.
- A maximum of 500 events of note data can be imported, with each note-on/off message counting as one event.
- In addition to note events, a total of up to 500 events of control change messages, channel pressure, and pitch bend can be imported. If you try to import more than the allowable number of events, the message **“Too Much Data!”** appears.

MEMO

- Before you continue, copy an SMF from your computer to the **“IMPORT”** folder of the SD card.
- A maximum of 200 files in the **“IMPORT”** folder can be detected.

1. Press the **[ARPEGGIO]** button.
2. Press the **[3] (Import SMF)** button.
The ARPEGGIO SMF IMPORT screen appears.
3. Use the dial or the **[DEC] [INC]** buttons to select the SMF that you want to import, and then press the **[7] (Import)** button.

MEMO

You can audition the selected SMF by pressing the **[6] (Preview)** button.

4. Use the dial or the **[DEC] [INC]** buttons to select the import-destination Style number (U001–U016).
5. Press the **[2] (Rename)** button and assign a name to the arpeggio style (p. 45).
6. Press the **[7] (Execute)** button.
A confirmation message appears.
If you decide to cancel, press the **[7] (Cancel)** button.
7. Press the **[6] (OK)** button.
The SMF is imported into the Style number you specified.

Creating an Arpeggio Style from a Song (Import Song)

You can create an original arpeggio style by importing a track from the currently selected song.

1. Press the **[ARPEGGIO]** button.
2. Press the **[3] (Import Song)** button.
The ARPEGGIO SONG IMPORT screen appears.
3. Use the dial or the **[DEC] [INC]** buttons to select the track that you want to import, and then press the **[7] (Import)** button.

MEMO

You can press the **[6] (Preview)** button to audition the selected track.

4. Use the dial or the **[DEC] [INC]** buttons to select the import-destination Style number (U001–U016).
5. Press the **[2] (Rename)** button and assign a name to the arpeggio style (p. 45).
6. Press the **[7] (Execute)** button.
A confirmation message appears.
If you decide to cancel, press the **[7] (Cancel)** button.
7. Press the **[6] (OK)** button.
The track of the song is imported into the specified Style number.

Using Chord Memory

Performing with the Chord Memory Function

Chord memory is a function that lets you register chord forms and then produce chords of that form simply by playing a single key.

MEMO

Chord form settings are saved in the studio set.

1. Press the **[CHORD MEMORY]** button to make it light.

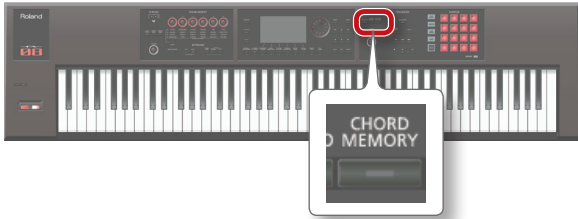

The chord memory function turns on, and the CHORD MEMORY screen appears.

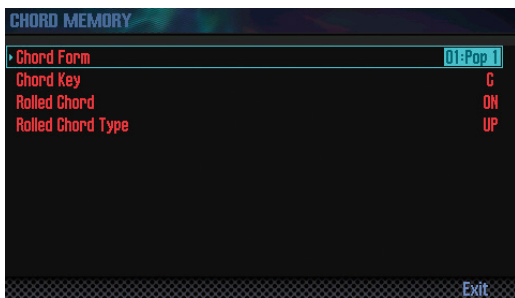

MEMO

If the FA is not in single play mode, make settings as follows depending on the mode that you're in.

Performance state	Action
Dual play	Turn on the arpeggio switch (ARP in the Dual screen or Split screen) for the part with which you want to use the chord memory function.
Split play	Turn on the arpeggio switch (ARP) for the part with which you want to use the chord memory function. For details, refer to "Parameter Guide" (PDF).
Multi part play	<ul style="list-style-type: none"> • Turn on the arpeggio switch (ARP) for the part with which you want to use the chord memory function. For details, refer to "Parameter Guide" (PDF). • Make the current part any part whose keyboard switch (p. 27) is on.

2. Play the keyboard.

A chord is sounded according to the currently selected chord form. For more about chord forms, refer to ["Chord Memory List"](#) (p.109).

3. To turn off the chord memory function, press the **[CHORD MEMORY]** button once again to make it go dark.

Chord Memory Settings

Here's how to edit the chord memory settings.

1. Press the **[CHORD MEMORY]** button to make it light.

The chord memory function turns on, and the CHORD MEMORY screen appears.

MEMO

By holding down the **[SHIFT]** button and pressing the **[CHORD MEMORY]** button, you can access the **"Chord Memory"** screen without changing the chord memory on/off status.

2. Use the cursor buttons to select a parameter, and use the dial to edit the value.

Parameter	Value	Explanation
Chord Form	01-17	Selects the type of chord set that's assigned to the C-B keys. For more about chord forms, refer to "Chord Memory List" (p.109).
Chord Key	G-F#	Changes the key of the chord.
Rolled Chord	ON	The notes of the chord sound sequentially rather than simultaneously. Since the speed of the performance changes depending on the force with which you play the keyboard, you can produce a realistic simulation of guitar playing just by varying your playing dynamics.
	OFF	The notes sound as a chord.
Rolled Chord Type	UP	Notes sound sequentially from low to high.
	DOWN	Notes sound sequentially from high to low.
	ALTERNATE	The order in which the notes sound alternates each time you play the keyboard.

Performing with Rhythm Patterns

The FA can sound a rhythm pattern while you perform.
The rhythm pattern plays the tone of part 10 of the studio set.

MEMO

Rhythm pattern settings are saved in the studio set.

What is a pattern?

The FA's rhythm patterns consist of performance data called "patterns."

In a band, the drummer typically repeats fixed sequences that are one or two measures long. On the FA, each of these basic sequences of performance data is called a "pattern."

The FA contains preset patterns that are suitable for intro, verse, fill, and ending. The pattern name indicates the type of pattern.

Pattern	Explanation
Intro	Performance pattern suitable for the intro (introduction).
Verse 1, 2	The main performance patterns. 1 is the basic pattern, and 2 is a more advanced form of 1.
Fill-In 1, 2	More elaborate performance patterns typically inserted between phrases. Choose either 1 or 2 depending on the pattern that will play following the fill.
Ending	Performance pattern suitable for the end of the song.

The FA provides the following types of pattern.

Pattern	Explanation
P (preset)	Preset patterns that cannot be rewritten. Pattern settings that you've edited can be saved as a user pattern.
U (user)	Patterns that you save in the FA.

MEMO

You can edit a pattern to create an original user pattern (p. 50).

What is a rhythm group?

A rhythm group is a set containing six rhythm patterns. You can choose a rhythm pattern for each of Intro, Pattern A–Pattern D, and Ending, and save your choices as a rhythm group.

Rhythm group	Explanation
PRST (preset)	Rhythm groups that cannot be rewritten. Rhythm group settings that you've edited can be saved as a user group.
USER (user)	Rhythm groups that you save in the FA.

What is a drum kit?

The drum sounds played by a pattern are called a "drum kit."
You can store one drum kit in each studio set.

Selecting/Playing Rhythm Patterns

Here's how to play rhythm patterns.

Selecting rhythm patterns

1. Press the [RHYTHM PATTERN] button to access the RHYTHM PATTERN screen.

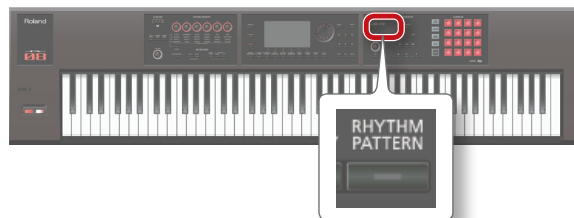

2. Select a rhythm group and drum kit.
 1. Move the cursor to "RHYTHM GROUP" or "DRUM KIT"
 2. Use the dial or the [DEC] [INC] buttons to select a rhythm group or drum kit.
3. Move the cursor to the rhythm pattern, and use the dial or the [DEC] [INC] buttons to select a rhythm pattern.

MEMO

- If you want to keep the rhythm group that you've edited, save the rhythm group (p. 37).
- Rhythm patterns are shown in the order of P (preset) → U (user).

Playing rhythm patterns

4. Press the [2] (Intro)–[7] (Ending) buttons to select the rhythm pattern that you want to play.
The [RHYTHM PATTERN] button lights, and the rhythm pattern plays.
5. To stop, once again press the button that you pressed in step 4.

MEMO

If you play a rhythm pattern that's assigned as Intro, playback automatically switches to Pattern A when the Intro has finished playing.

If you play a rhythm pattern that's assigned as Ending, the rhythm pattern automatically stops when the Ending has finished playing.

About the RHYTHM PATTERN screen



No.	Explanation
1	Rhythm group, rhythm group number, rhythm group name
2	Drum kit type, bank, number, and name
3	PATTERN KEY TRIGGER settings
4	Rhythm pattern, number, name
5	Tempo and current position of the rhythm pattern

Changing the Tempo of the Rhythm Pattern

Here's how to change the tempo of the rhythm pattern.

1. Turn the **[TEMPO]** knob.



MEMO

- You can set the tempo in a range of 5–300. You can use the **[TEMPO]** knob to set the tempo in a range of 60–240.
- You can set the tempo by pressing the **[TAP]** button at the desired interval (Tap Tempo). Press the button at least three times at quarter-note intervals of the desired tempo.
- When you press the **[TAP]** button, the Tempo window appears. In this state, you can hold down the **[SHIFT]** button and turn the dial to adjust the value below the decimal point. If you press the **[6] (Click)** button, a click is sounded at the specified tempo. The click turns on/off each time you press the button.

Saving a Rhythm Group

A rhythm group you've edited is temporary; it disappears if you turn off the power or select a different rhythm group.

If you want to keep the rhythm group you've edited, save it to the user group in the FA.

NOTE

When you execute the Save operation, the data previously in the save-destination is overwritten.

1. In the RHYTHM PATTERN screen, hold down the **[SHIFT]** button and press the **[7] (Write)** button.
2. Move the cursor to the save-destination, and use the dial or the **[DEC] [INC]** buttons to select the save-destination.
3. Press the **[2] (Rename)** button and assign a name to the rhythm group (p. 45).
4. Press the **[7] (Write)** button.
A confirmation message appears.
If you decide to cancel, press the **[7] (Cancel)** button.
5. Press the **[6] (OK)** button.
The rhythm group is saved.

NOTE

Never turn off the power while data is being saved.

Importing SMF into a Rhythm Pattern

You can create an original rhythm pattern by importing SMF (Standard MIDI File) data.

SMF that can be imported

- Set the rhythm part of the SMF to MIDI channel 10.
- Up to 4,000 events of MIDI data can be imported. If there are more than 4,000 events, the message “**Too Much Data!**” appears.
- The SMF being imported can be no longer than 32 measures.

MEMO

- Before you continue, copy the SMF from your computer into the “**IMPORT**” folder of the SD card.
- A maximum of 200 files can be recognized in the “**IMPORT**” folder.

1. Press the **[RHYTHM PATTERN]** button.
2. Hold down the **[SHIFT]** button and press the **[4] (Import SMF)** button.
The RHYTHM PATTERN SMF IMPORT screen appears.
3. Use the dial or the **[DEC] [INC]** buttons to select the SMF that you want to import, and then press the **[7] (Import)** button.
4. Use the dial or the **[DEC] [INC]** buttons to select the import-destination rhythm pattern number (U001–U120).
5. Press the **[2] (Rename)** button and assign a name to the rhythm pattern (p. 45).
6. Press the **[7] (Execute)** button.
A confirmation message appears.
If you decide to cancel, press **[7] (Cancel)**.
7. Press the **[6] (OK)** button.
The SMF is imported into the rhythm pattern.

Creating a Rhythm Pattern from a Song

You can create an original rhythm pattern from track 10 of the currently selected song.

1. Press the **[RHYTHM PATTERN]** button.
2. Hold down the **[SHIFT]** button and press the **[5] (Import Song)** button.
The RHYTHM PATTERN SONG IMPORT screen appears.
3. Use the dial or the **[DEC] [INC]** buttons to select the import-destination rhythm pattern number (U001–U120).
MEMO
You can audition the track by pressing the **[5] (Preview)** button.
4. Press the **[2] (Rename)** button and assign a name to the rhythm pattern (p. 45).
5. Press the **[7] (Execute)** button.
A confirmation message appears.
If you decide to cancel, press **[7] (Cancel)**.
6. Press the **[6] (OK)** button.
The data is imported as a rhythm pattern.

Modifying the Sound in Real Time

Using the SOUND MODIFY Knobs to Vary the Sound

You can use the SOUND MODIFY knobs to control the sound in real time.

You can control a total of 24 parameters, organized as four groups of six parameters.

Group that is controlled (lit)

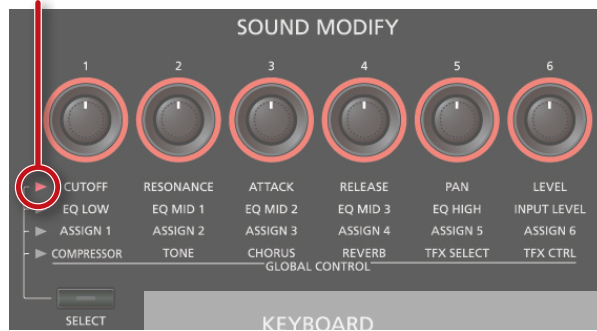

1. Press the **[SELECT]** button to select the group of parameters that you want to control.
2. Turn the **[1]–[6]** knobs.

The sound changes according to the knob that you turn.

MEMO

- If you like, you can make the SOUND MODIFY knob settings be reset whenever you switch tones in Single play mode (Auto Knob Reset: p. 99).
- For some sounds, certain knobs might not produce any effect. For details, refer to “[Parameter Guide](#)” (PDF).

Changing the Tonal Character of the Part (CUTOFF, RESONANCE)

The filter is one of the things that determine the character of the sound.

The filter modifies the tonal character by cutting or boosting different frequency regions of the sound.

- * This affects the current part.

MEMO

For details, refer to “[Settings for Each Part](#)” (p.44).

Changing How the Volume Will Vary of the Part (ATTACK, RELEASE)

You can adjust the time over which the volume rises from note-on to its peak, and the time over which the volume falls to silence after you release the key.

- * This affects the current part.

MEMO

For details, refer to “[Settings for Each Part](#)” (p.44).

Changing the Stereo Position of the Sound of the Part (PAN)

You can adjust the stereo position (pan) of the part.

- * This affects the current part.

MEMO

For details, refer to “[Settings for Each Part](#)” (p.44).

Adjusting the Volume of the Part (LEVEL)

You can adjust the volume of the part.

- * This affects the current part.

MEMO

For details, refer to “[Settings for Each Part](#)” (p.44).

Adjusting the Level of the Low, Mid, and High Frequencies (EQ)

You can adjust the equalizer (EQ) that is applied to the overall sound.

MEMO

For details, refer to “[Parameter Guide](#)” (PDF).

Adjusting the Input Volume (INPUT LEVEL)

You can adjust the input volume of the AUDIO INPUT jack (Audio Input Level: p. 80).

When using sampling (p. 79) or the vocoder (p. 42), this is a convenient way to adjust the input volume of the device that’s connected to the AUDIO INPUT jack.

Applying an Assigned Function (ASSIGN 1–6)

You can assign a variety of parameters to ASSIGN 1–6.

1. Hold down the **[SHIFT]** button and turn the **[1]–[6]** (**ASSIGN 1–6**) knobs.
2. Use the cursor buttons to select a parameter, and use the dial to change the value.

MEMO

For details on the parameters, refer to “[Sound Modify Knob 1–6 Assign](#)” (p.99).

Applying Effects Conveniently (GLOBAL CONTROL)

The FA provides “**global control**” that lets you apply effects conveniently.

“**Global control**” is technology that lets you optimize multiple parameters of an effect simply by turning a single knob.

Knob	Explanation
[1] (COMPRESSOR)	If you turn the knob all the way to the left, no compressor effect will be applied. Turning the knob toward the right will smooth out the overall volume, making your sound more consistent.
[2] (TONE)	Turning the knob toward the left will boost the mid-range, making the sound punchier. This is appropriate when playing in a band. Turning the knob toward the right will boost the low and high-frequency ranges, producing a more colorful sound. This is appropriate for solo performances.
[3] (CHORUS)	If you turn the knob all the way to the left, no chorus effect will be applied. Turning the knob toward the right will make the chorus deeper.
[4] (REVERB)	If you turn the knob all the way to the left, no reverb effect will be applied. Turning the knob toward the right will make the reverb deeper.
[5] (TFX SELECT)	Selects the type of total effect. You can choose one of 29 types of total effect to be applied.
[6] (TFX CTRL)	Controls the parameters of the total effect you selected.

Total effect types

No.	Type	Explanation
01	FILTER+DRIVE	A low-pass filter with overdrive. It cuts the high frequencies and adds distortion.
02	ISOLATOR	Isolates or removes the low, mid, or high frequency ranges.
03	DJFX LOOPER	Loops a short portion of the input sound. You can vary the playback direction and playback speed of the input sound to add turntable-type effects.
04	BPM LOOPER	Loops the input sound over a short period.
05	BIT CRASH	Produces an extreme lo-fi effect.
06	WAH	Produces a wah effect.
07	REVERB	Adds reverberation to the sound.
08	DELAY	Repeats the sound.
09	TAPE ECHO	Simulates a tape-type echo unit of the past.
10	PITCH	Changes the pitch.
11	VOICE TRANS	Processes a human voice to create a variety of characters.
12	FLANGER	Creates modulation reminiscent of a jet airplane taking off and landing.
13	SLICER+FLG	Repeatedly cuts the sound. A flanger is added.
14	PHASER	Creates modulation by adding a phase-shifted sound.
15	CHORUS	Adds spaciousness and richness to the sound.
16	TREMOLO/PAN	Cyclically varies the volume or panning.
17	OVERDRIVE	Mildly distorts the sound.
18	DISTORTION	Intensely distorts the sound.
19	FUZZ	Adds overtones and intensely distorts the sound.
20	OCTAVE	Adds a pitch at lower octaves.
21	SUBSONIC	Adds a low-frequency sine wave based on the volume being input to the effect.
22	RING MOD	Gives the sound a metallic character.
23	CHROMATIC PS	A two-voice pitch shifter that changes the pitch in semitone steps.
24	C.CANCELLER	Cancels the vocal or other sound located in the center.
25	VINYL SIM	Simulates sound heard from an analog record.
26	RADIO TUNING	Simulates sound heard from a radio.
27	NOISE GEN	Applies a lo-fi effect, and also adds noises such as white noise and record noise.
28	COMP	Makes the sound more consistent.
29	EQUALIZER	Adjusts the volume of each frequency region.

MEMO

For details on the parameters of the total effects, refer to “**Parameter Guide**” (PDF).

Moving Your Hand to Vary the Pitch or Volume (D-BEAM Controller)

The D-BEAM is a controller that you use simply by positioning your hand above it. You can change the function that's assigned, and use this controller to apply a variety of effects.

1. Press one of the D-BEAM **[SOLO SYNTH]**, **[EXPRESSION]**, or **[ASSIGNABLE]** buttons to turn on the D-BEAM controller (the button lights).

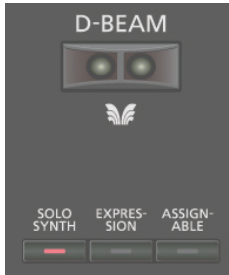

Button	Explanation
[SOLO SYNTH]	Play a monophonic synthesizer by moving your hand above the D-BEAM controller.
[EXPRESSION]	Use the D-BEAM controller to control volume.
[ASSIGNABLE]	Various parameters and functions can be assigned. The effect that's most appropriate for each tone is applied. Hold down the [SHIFT] button and press this button to access a screen where you can assign a function. You can also assign a parameter by holding down the [ASSIGNABLE] button and turning the SOUND MODIFY knob or pressing a pad.

MEMO

You can assign a performance-related function to the **[ASSIGNABLE]** button. For details, refer to "D-Beam Assign" (p.100).

2. While you play the keyboard, position your hand above the D-BEAM controller.
The effect selected by the button you pressed is applied.
3. To turn off the D-BEAM controller, once again press the button that you pressed in step 1 (the button goes dark).

Effective range of the D-BEAM controller

This illustration shows the effective range of the D-BEAM controller. No effect will be obtained if you position your hand outside the effective range.

NOTE

The effective range of the D-BEAM controller will change depending on the lighting conditions. If the D-BEAM controller does not work as you expect, readjust the sensitivity. For details on readjusting the sensitivity, refer to "D-Beam Sens" (p.99).



Changing the Pitch (Pitch Bend)

While playing the keyboard, move the lever to the left to lower the pitch, or toward the right to raise the pitch. This is called pitch bend.



Applying Vibrato or Dynamics (Modulation)

Move the lever away from yourself to apply vibrato or dynamics.



Using an Assigned Function to Vary the Sound ([S1] [S2] buttons)

You can assign performance-related functions to the **[S1]** **[S2]** buttons. When you turn the **[S1]** **[S2]** buttons on/off, the assigned function is switched or turned on/off.

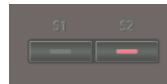

MEMO

You can assign performance-related functions to the **[S1]** **[S2]** buttons. For details, refer to "Switch S1 Assign/Switch S2 Assign" (p. 98).

- Overview
- Performing
- Performance Functions
- Editing
- Sequencer (Creating Songs)
- Sampler
- Pads
- DAW
- Settings
- Appendix

Using a Pedal to Vary the Sound

The FA allows you to connect hold pedals and control pedals. If a pedal switch (DP series; sold separately) is connected to the rear panel HOLD jack, notes will be sustained (held) while you hold down the pedal even after you take your hands off the keyboard. If an expression pedal (EV-5; sold separately) or pedal switch is connected to the rear panel CTRL 1 or CTRL 2 jack, you can use the pedal to vary the volume or control a variety of functions.

Sustaining the Notes (Hold Pedal)

While playing the keyboard, step on the pedal switch. You can hold (sustain) the notes by stepping on the pedal switch.



Adding Expression to Your Performance (Control Pedal)

While playing the keyboard, raise or lower the expression pedal. You can make your performance more expressive by varying the volume.

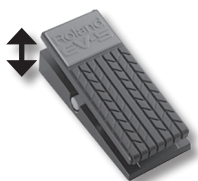

* Use only the specified expression pedal (EV-5; sold separately). By connecting any other expression pedals, you risk causing malfunction and/or damage to the unit.

MEMO

Performance-related functions can be assigned to the pedals connected to the CTRL 1 and CTRL 2 jacks. For details, refer to “Control Pedal 1 Assign/Control Pedal 2 Assign” (p. 98).

Performing with a Microphone (Vocoder)

The FA uses MFX to provide a vocoder. You can connect your microphone to the rear panel GUITAR/MIC jack and apply a vocoder effect to it.

* The vocoder is available only for part 1.

Adjusting the microphone’s input volume

Use the rear panel [LEVEL] knob to adjust the volume. If the volume is insufficient, or if you’re unable to adjust the volume successfully, refer to “Adjusting the Input Volume (INPUT LEVEL)” (p.39).

Using the Vocoder

1. Select one of the SuperNATURAL synth tone presets “1111 Vocoder Robt–1115 Vocoder Ens.”

For details on how to select a tone, refer to p. 22.

2. While you play the keyboard, vocalize into the microphone.

* Sound is not produced if you simply play the keyboard without vocalizing.

MEMO

Even with tones other than those listed above, you can apply a vocoder effect by selecting “68: Vocoder” for MFX.

Editing the Vocoder Settings

1. Select one of the SuperNATURAL synth tone presets “1111 Vocoder Robt–1115 Vocoder Ens.”
2. Hold down the [SHIFT] button and press the [3] (Effects Edit) button.

3. Press the [2] (MFX) button.

The TONE EDIT screen appears. In this case, “68: Vocoder” is selected for MFX.

4. Use the cursor buttons to select a parameter, and use the dial to edit the value.

Parameter	Value	Explanation
Mic Sens	0–127	Adjusts the microphone’s input sensitivity.
Synth Level	0–127	Adjusts the instrument’s input level.
Mic Mix	0–127	Adjusts the amount of microphone audio that is added to the vocoder’s output.
Level	0–127	Adjusts the volume level of the signal that has passed through the vocoder.
MFX Chorus Send Level	0–127	Adjusts the amount of chorus applied to the sound that has passed through the multi-effect.
MFX Reverb Send Level	0–127	Adjusts the amount of reverb applied to the sound that has passed through the multi-effect.

If you want to keep the settings, save the tone (p. 48).

04: Editing

Explains how to edit studio sets, tones, and effects.

Editing a Studio Set	44
Editing a Tone	46
Editing a Pattern	50
Editing the Effects	52

Editing a Studio Set

Overall Settings for the Studio Set

Here's how to make settings that apply to the entire studio set.

1. Press the **[MENU]** button.
2. Move the cursor to **"Studio Set Common"** and press the **[ENTER]** button.

The STUDIO SET COMMON screen appears.

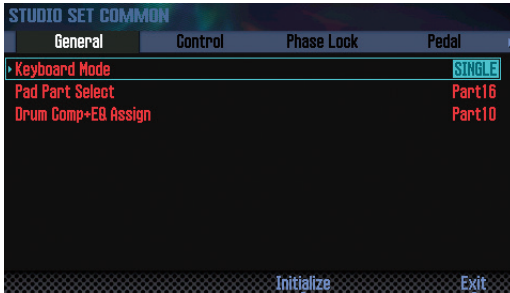

MEMO

From the STUDIO SET PLAY screen, you can also access the STUDIO SET COMMON screen by holding down the **[SHIFT]** button and pressing the **[5]** (**Studio Common**) button.

3. Use the cursor buttons to select an item, and use the dial to edit the setting.

NOTE

The edits you make to the studio set are temporary. They will be lost if you turn off the power or select another studio set. If you want to keep the changes, save the studio set (p. 45).

Common Parameters

MEMO

For details on the common parameters, refer to **"Parameter Guide"** (PDF).

Tab	Explanation
General	Specify the play mode, pad part, and the drum part to which Comp+EQ applies.
Control	Specify the MIDI messages used to control parameters when using tone control 1–4.
Phase Lock	Turn this "on" if you want to minimize inconsistency between the note-on timing of parts that are played on the same MIDI channel.
Pedal	Specify the MIDI messages used to control parameters when using a pedal connected to the CTRL 1 and CTRL 2 jacks.
S1/S2	Specify the MIDI messages used to control parameters when using the [S1] [S2] buttons.
Knob	Specify the MIDI messages used to control parameters when using the SOUND MODIFY knobs.
D-Beam	Specify the MIDI messages used to control parameters when using the D-BEAM controller.
Control Sw	For each part, specify whether various controller operations will be enabled (ON) or disabled (OFF).

Settings for Each Part

A studio set has 16 parts; each part has its own settings such as volume (Level), equalizer (EQ), and key range (Keyboard).

1. Access the PART VIEW screen (p. 26).



2. Use the cursor buttons to select a parameter, and use the dial to edit the value.

To switch tabs, hold down the **[SHIFT]** button and use the cursor **[◀]** **[▶]** buttons.

Part parameters

MEMO

For details on the part parameters, refer to **"Parameter Guide"** (PDF).

Tab	Explanation
Level/Pan	Specify each part's tone, level, pan, and MIDI receive settings.
Keyboard	Specify each part's key range, and whether the arpeggiator is applied.
Output/EFX	Specify each part's output destination, and the level of signal that is sent to chorus and reverb.
EQ	Edit the equalizer that is applied to each part.
Pitch	Specify each part's pitch and portamento setting.
Scale Tune	Specify the scale tune settings of each part.
Vibrato	Edit each part's vibrato settings.
Offset	Specify offsets for parameters such as cutoff and resonance.
Mono/Poly/Legato	Edit each part's mono, poly, and legato settings.
Voice Reserve	Specify the number of voices that are reserved for each part.
MIDI Rx Filter	Specify the MIDI messages that are received by each part.

* Depending on the sound, some part parameters have no effect.

Saving a Studio Set

Edits you make to a studio set are temporary. They are lost if you turn off the power or select another studio set. If you want to keep the changes you make, save the studio set.

NOTE

When you save the studio set, the data that was previously in the save-destination is overwritten.

1. Press the [WRITE] button.

The WRITE MENU window appears.

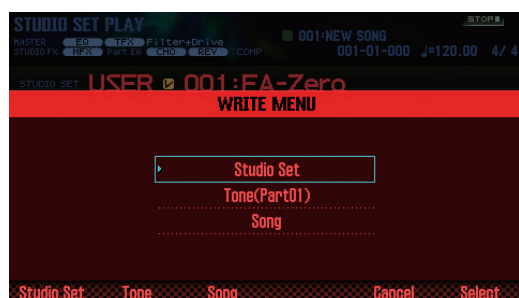

2. Move the cursor to “Studio Set” and press the [ENTER] button.

3. Use the dial or the [DEC] [INC] buttons to select the save-destination.

4. Press the [2] (Rename) button and assign a name.

Controller	Explanation
Dial or [DEC] [INC]	Specify the character that you want to enter.
[◀] [▶]	Move the cursor.
[▲] [▼]	Switch between uppercase and lowercase alphabetical characters.
[4] (Delete)	Deletes the character at the cursor location.
[5] (Insert)	Inserts a space (blank) at the cursor location.
[6] (Cancel)	Cancels input and exits the naming screen.
[7] (OK)	Confirms the name.

5. Press the [7] (OK) button.

6. Press the [7] (Write) button.

A confirmation message appears.

If you decide to cancel, press the [7] (Cancel) button.

7. Press the [6] (OK) button.

The studio set is saved.

NOTE

Never turn off the power while data is being saved.

Initializing a Studio Set (Studio Set Init)

Here's how to initialize the currently selected studio set.

1. Press the [MENU] button.

2. Move the cursor to “Studio Set Init” and press the [ENTER] button.

3. Select the content that you want to initialize, and then press the [7] (Select) button.

Parameter	Explanation
Studio Set	All settings of the studio set are initialized.
Sound Control	Each part's vibrato and the following offset parameters are initialized. <ul style="list-style-type: none"> • Cutoff Offset • Resonance Offset • Attack Offset • Decay Offset • Release Offset • Vibrato Rate • Vibrato Depth • Vibrato Delay

A confirmation message appears.

If you decide to cancel, press the [7] (Cancel) button.

4. Press the [6] (OK) button.

The studio set is initialized.

NOTE

Never turn off the power while initialization is in progress.

Initializing a Part (Part Init)

Here's how to initialize the part settings of the current part.

1. In the PART VIEW screen (p. 26), press the [5] (Part Init) button.

A confirmation message appears.

If you decide to cancel, press the [7] (Cancel) button.

2. Press the [6] (OK) button.

The part is initialized.

* The Voice Reserve setting is not initialized.

NOTE

Never turn off the power while initialization is in progress.

Editing a Tone

Here's how to edit the tone that's assigned to a part.

Basic Procedure for Tone Edit

1. Select the part to which the tone is assigned.
2. Press the [MENU] button.
3. Move the cursor to "Tone Edit" and press the [ENTER] button.
The TONE EDIT screen appears.
The TONE EDIT screen differs according to the type of tone that's selected for the part.
4. Use the cursor buttons to select an item, and use the dial to edit the value.

NOTE

Edits you make to a tone are temporary. The changes you make are lost when you turn off the power or select another tone. If you want to keep the edited settings, save the tone (p. 48).

MEMO

- From the STUDIO SET PLAY screen, you can also access the TONE EDIT screen by holding down the [SHIFT] button and pressing the [2] (Tone Edit) button.
- In the TONE EDIT screen, you can also press the [6] (Part Select) button to switch the part that you're editing.
- For details on the tone parameters, refer to "Parameter Guide" (PDF).

SuperNATURAL Acoustic Tone (SN-A)

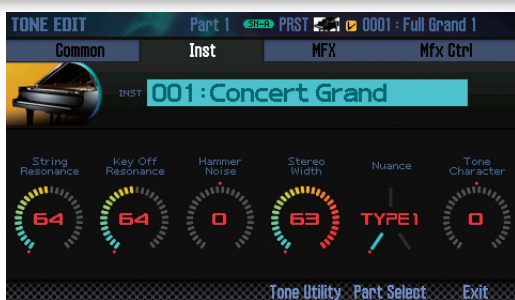
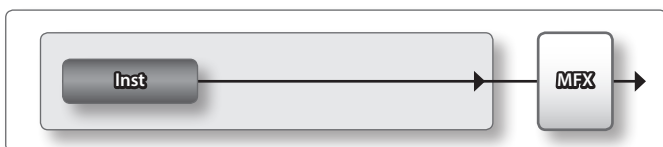

Tab	Explanation
Common	Settings that apply to the entire tone.
Inst	Settings for the INST assigned to the tone. These are detailed settings for the INST that's assigned.
MFX	Settings for the multi-effect.
MFX Control	Settings for controlling MFX via MIDI.

Inst

An "inst" is the smallest unit of sound within a SuperNATURAL acoustic tone. Each SuperNATURAL acoustic tone consists of a single "inst."

SuperNATURAL Synth Tone (SN-S)

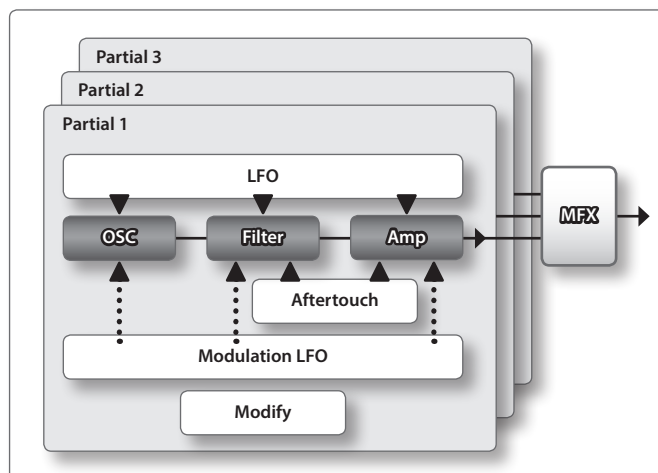

Tab	Explanation
Common	Settings that apply to the entire tone.
OSC	Settings for the waveform that is the basis of the tone.
Pitch	Settings related to pitch.
Filter	Settings related to the filter.
Amp	Settings related to the volume.
LFO	Settings for the LFO that modulates the sound.
Modulation LFO	Settings for the modulation applied to the sound.
Aftertouch	Settings related to aftertouch. MEMO To use aftertouch, assign it to a SOUND MODIFY knob or the D-BEAM controller. For details on how to make these settings, refer to "Overall Settings for the Studio Set" (p.44) or "Settings for the Entire" (p.97).
Misc	Settings for envelopes and portamento time control.
MFX	Settings for the multi-effect.
MFX Control	Settings for controlling MFX via MIDI.

Partial

A "partial" is a unit of sound within a SuperNATURAL synth tone, SuperNATURAL drum kit, PCM synth tone, or PCM drum kit. These tones consist of multiple partials.

SuperNATURAL Drum Kit (SN-D)

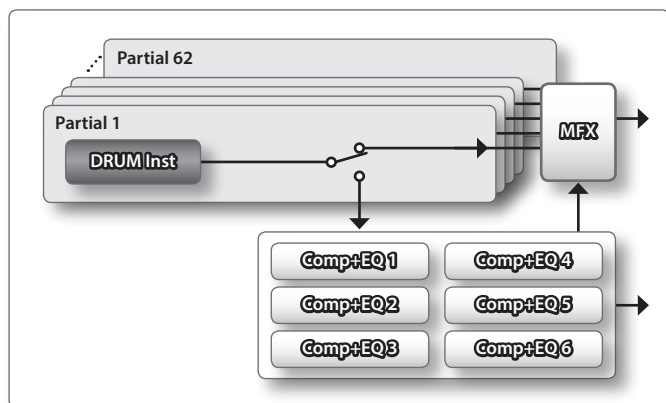

Tab	Explanation
Common	Settings that apply to the entire tone.
DRUM Inst	Instrument settings for each partial. MEMO You can press a key to switch the partial number that you're editing.
Comp	Settings for the Drum Comp+EQ Assign part compressor.
EQ	Settings for the Drum Comp+EQ Assign part equalizer.
MFX	Settings for the multi-effect.
MFX Control	Settings for controlling MFX via MIDI.

MEMO

The Drum Comp+EQ Assign part setting is located in the overall settings for the studio set.

PCM Synth Tone (PCMS)

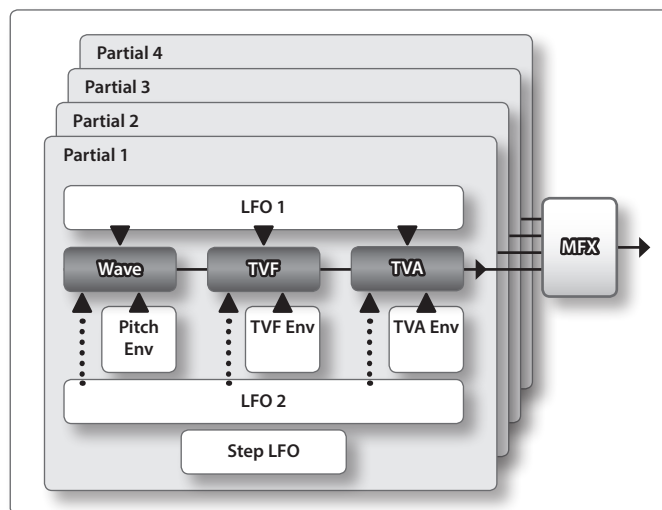

Tab	Explanation
Common	Settings that apply to the entire tone.
Wave	Settings for the waveform that is the basis of the tone.
PMT (Partial Mix Table)	Settings for how partials are combined, and for key range.
Pitch	Settings related to pitch.
Pitch Env	Settings for the pitch envelope.
TVF	Settings related to the filter.
TVF Env	Settings for the TVF envelope.
TVA	Settings related to volume.
TVA Env	Settings for the TVA envelope.
Output	Settings related to output.
LFO 1	Settings for the LFO that modulates the sound.
LFO 2	Settings for the LFO that modulates the sound.
Step LFO	Settings that specify how steps 1–16 will modulate the sound.
Control	Settings related to controllers.
Matrix Control1	Settings related to matrix controls 1–4.
Matrix Control2	
Matrix Control3	
Matrix Control4	
MFX	Settings for the multi-effect.
MFX Control	Settings for controlling MFX via MIDI.

MEMO

You can't edit the sounds of the GM2 bank.

PCM Drum Kit (PCMD)

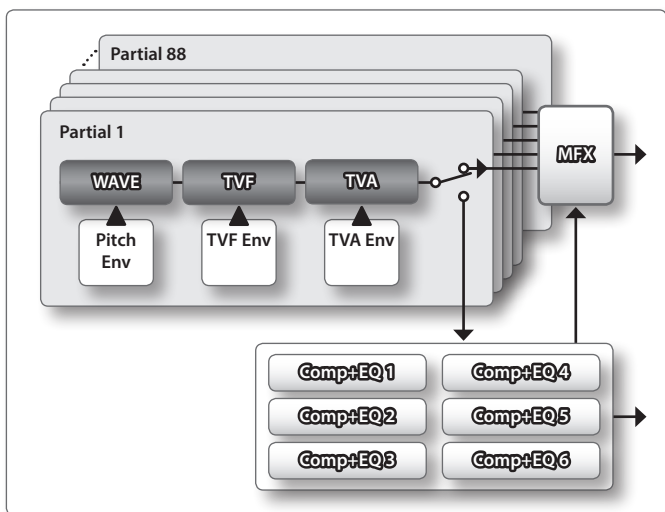

Tab	Explanation
Common	Settings that apply to the entire tone.
Wave	Settings for the waveform that is the basis of the tone.
WMT (Wave Mix Table)	Make settings for velocity-switching between tones.
Pitch	Settings related to pitch.
Pitch Env	Settings for the pitch envelope.
TVF	Settings related to the filter.
TVF Env	Settings for the TVF envelope.
TVA	Settings related to volume.
TVA Env	Settings for the TVA envelope.
Output	Settings related to output.
Comp	Settings for the Drum Comp + EQ Assign part compressor.
EQ	Settings for the Drum Comp + EQ Assign part equalizer.
MFX	Settings for the multi-effect.
MFX Control	Settings for controlling MFX via MIDI.

MEMO

- You can press a key to switch the partial number that you're editing.
- The Drum Comp+EQ Assign part setting is located in the overall settings for the studio set.
- You can't edit the sounds of the GM2 bank.

Saving a Tone/Drum Kit

Edits you make to a Tone/Drum Kit are temporary; they will be lost when you turn off the unit or select another Tone/Drum Kit. If you want to keep an edited Tone/Drum Kit, you must save it.

NOTE

When you execute the Write operation, the existing data at the write destination will be overwritten.

1. Press the [WRITE] button.

The WRITE MENU window appears.

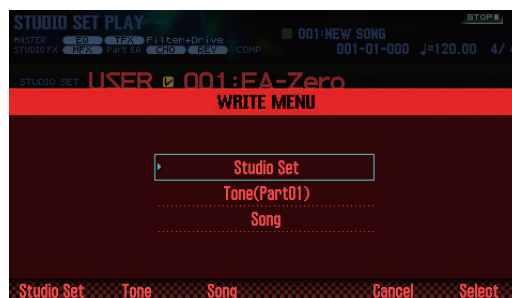

2. Move the cursor to "Tone" and press the [ENTER] button.

3. Use the dial or the [DEC] [INC] buttons to select the save-destination.

4. Press the [2] (Rename) button and assign a name to the tone/drum kit (p. 45).

5. Press the [7] (Write) button.

A confirmation message appears.

If you decide to cancel, press the [7] (Cancel) button.

6. Press the [6] (OK) button.

The tone/drum kit is saved.

NOTE

Never turn off the power while data is being saved.

Initializing a Tone (Tone Initialize)

Here's how to initialize the settings of the current tone.

1. In the TONE EDIT screen (p. 46), press the [5] (Tone Utility) button.

2. Choose "Tone Initialize," and press the [7] (Select) button.

A confirmation message appears.

If you decide to cancel, press the [7] (Cancel) button.

3. Press the [6] (OK) button.

The tone or drum kit is initialized.

NOTE

Never turn off the power while initialization is in progress.

Selecting the Partial That Sound (Partial Switch)

You can select the partials/waves that are sounded by a SuperNATURAL synth tone, PCM synth tone, or PCM drum kit.

1. In the TONE EDIT screen (p. 46), press the **[2] (Partial Sw)** button.
2. Use the **[4] (Sw 1)–[7] (Sw 4)** buttons to select the partials/waves that you want to sound, and then press the **[2] (Exit)** button.

MEMO

- For a SuperNATURAL synth tone, you can use the **[5] (Sw 1)–[7] (Sw 3)** buttons to select partials.
- You can use the pads to select partials (p. 84).

Selecting the Partial to Edit (Partial Select)

Here's how to select the partials of a SuperNATURAL synth tone, SuperNATURAL drum kit, PCM synth tone, or PCM drum kit.

1. In the TONE EDIT screen (p. 46), press the **[3] (Partial Sel)** button.
2. Use the **[4] (Select 1)–[7] (Select 4)** buttons to select the partials that you want to edit, and then press the **[2] (Exit)** button.

* You can't turn off all of the partials.

MEMO

- For a SuperNATURAL synth tone, you can use the **[5] (Select 1)–[7] (Select 3)** buttons to select partials.
- For a SuperNATURAL drum kit, you can select only one partial.
- You can use the pads to select partials (p. 84).

Initializing a Partial (Partial Initialize)

Here's how to initialize a partial of a SuperNATURAL synth tone, SuperNATURAL drum kit, PCM synth tone, or PCM drum kit.

1. In the TONE EDIT screen (p. 46), press the **[5] (Tone Utility)** button.
2. Select **"Partial Initialize"** and press the **[7] (Select)** button.
3. Select the partial that you want to initialize, and press the **[7] (Select)** button.
A confirmation message appears.
If you decide to cancel, press the **[7] (Cancel)** button.
4. Press the **[6] (OK)** button.
The partial is initialized.

NOTE

Never turn off the power while initialization is in progress.

Copying a Partial (Partial Copy)

Here's how to copy the partial settings of a SuperNATURAL synth tone, SuperNATURAL drum kit, PCM synth tone, or PCM drum kit.

1. In the TONE EDIT screen (p. 46), press the **[5] (Tone Utility)** button.
2. Select **"Partial Copy"** and press the **[7] (Select)** button.
3. Select the copy-source partial and copy-destination partial.
A confirmation message appears.
If you decide to cancel, press the **[7] (Cancel)** button.
4. Press the **[6] (OK)** button.
The partial is copied.

Editing a Pattern

In addition to using the preset patterns, you are also free to create and use your own patterns.

You can save your edited content as a user pattern.

1. Select the pattern that you want to edit (p. 36).
2. In the RHYTHM PATTERN screen (p. 36), hold down the [SHIFT] button and press the [6] (Ptn Edit) button.
The PATTERN EDIT screen appears.

About the PATTERN EDIT screen



Function button operations

Button	Explanation	Page
[2] (Setup)	Specifies the pattern's time signature and length.	p. 50
[3] (Note Setup)	Specifies the note type, length and loudness.	p. 51
[4] (Clear Step)	Deletes all notes from the vertical axis at the cursor location.	p. 51
[5] (Clear Note)	Deletes all notes from the horizontal axis at the cursor location.	p. 51
[6] (Scale)	Specifies the scale of the grid.	p. 50
[7] (Write)	Saves the pattern.	p. 51
[SHIFT] + [7] (Initialize)	Initializes the pattern.	p. 50

Other controllers

Controller	Explanation
Cursor	Selects the location at which you want to input a note.
Keyboard	Specifies the pitch (same as the cursor [▲] [▼] buttons).
[ENTER]	Enters/deletes a note.
[DEC] [INC]	
[▶]	Plays the pattern.
[■]	Stops pattern playback.

Initializing a Pattern (Initialize)

Initialize the pattern if you want to create a pattern from scratch rather than starting with an existing rhythm pattern.

1. In the PATTERN EDIT screen, hold down the [SHIFT] button and press the [7] (Initialize) button.
A confirmation message appears.
If you decide to cancel, press the [7] (Cancel) button.
2. Press the [6] (OK) button.
The pattern is initialized.

Specifying the Time Signature and Length (Setup)

Here's how to specify the time signature and length of the pattern.

1. In the PATTERN EDIT screen, press the [2] (Setup) button.
2. Use the cursor buttons to select a parameter, and use the dial to edit the value.

Parameter	Value	Explanation
Pattern Time Signature	2/4–7/4, 5/8–7/8, 9/8, 12/8, 9/16, 11/16, 13/16, 15/16, 17/16, 19/16	Time signature of the pattern This can be specified only for an empty pattern.
	1–32 * This cannot be shorter than the number of measures that contain data.	Pattern length

3. To close the setup window, press the [6] (Close) button or the [EXIT] button.

Specifying the Grid Scale (Scale)

Here you can specify the scale of the grid.

1. In the PATTERN EDIT screen, press the [6] (Scale) button.
The scale of the grid changes each time you press the button.

Parameter	Value
Scale	Sixteenth note, thirty-second note, eighth-note triplet, sixteenth-note triplet

Specifying the Note Type, Duration, and Loudness (Note Setup)

Here you can specify the type of notes to enter, as well as their duration and loudness.

1. In the PATTERN EDIT screen (p. 50), press the [3] (Note Setup) button.
2. Use the cursor buttons to select a parameter, and use the dial to edit the value.

Parameter	Value	Explanation
Note Type	Refer to "Note values"	Selects the rhythmic value of the notes that you input.
Gate Time	5–200 %	Specifies the gate time (the length for which the note will sound) of the notes that you input, as a percentage of the rhythm value specified by Note Type.
Velocity	1–127	Specifies the velocity (volume) of the note messages that you input.
Input by Keyboard	OFF, ON	If this is on, you can use the keyboard to enter notes. * Use the 16 right-most white keys to enter notes (the black keys are ignored). * The velocity with which you actually play the key is entered as the note-on velocity.

3. To close the editing window, press the [6] (Close) button or the [EXIT] button.

Note values

1/32 (♪)	Thirty-second note	1/24 (♪)	Sixteenth-note triplet
1/16 (♪)	Sixteenth note	1/12 (♪)	Eighth-note triplet
1/8 (♪)	Eighth note	1/6 (♪)	Quarter-note triplet
1/4 (♪)	Quarter note	1/2 (♪)	Half note
1/1 (♩)	Whole note		

Entering Notes

1. In the PATTERN EDIT screen (p. 50), move the cursor to the location at which you want to enter a note.
2. Press the [INC] or [ENTER] button; a note is entered.

MEMO

- You can also press a key to specify the pitch (the same operation as the cursor [▲] [▼] buttons).
- If you once again press the [ENTER] button at a location where a note exist, the note is deleted.
- Notes are input according to the Note Set settings.

Deleting Notes (Clear Step, Clear Note)

1. In the PATTERN EDIT screen (p. 50), move the cursor to the location at which you want to delete notes.
2. Press one of the following buttons to delete notes.

Button	Explanation
[DEC] or [ENTER]	Delete the note at the cursor location.
[3] (Clear Step)	Deletes all notes from the vertical axis of the cursor location.
[4] (Clear Note)	Deletes all notes from the horizontal axis of the cursor location.

Saving the Pattern

A pattern you create is temporary, and is lost if you turn off the power or select another pattern.

If you want to keep the pattern that you created, save it on the FA as a user pattern.

NOTE

The Save operation overwrites any data that was previously in the save-destination.

1. In the PATTERN EDIT screen (p. 50), press the [7] (Write) button.
2. Move the cursor to the save-destination, and use the dial or the [DEC] [INC] buttons to select the save-destination.
3. Press the [2] (Rename) button and assign a name to the pattern (p. 45).
4. Press the [7] (Write) button.
A confirmation message appears.
If you decide to cancel, press the [7] (Cancel) button.
5. Press the [6] (OK) button.
The pattern is saved.

NOTE

Never turn off the power while data is being saved.

Editing the Effects

Turning Effects On/off

Here's how to turn effects on/off.

1. Press the **[MENU]** button.
2. Move the cursor to **"Effects Edit"** and press the **[ENTER]** button.

The EFFECTS EDIT screen appears.

In the EFFECTS EDIT screen, you can edit the parameters in detail while you view the effect routing.

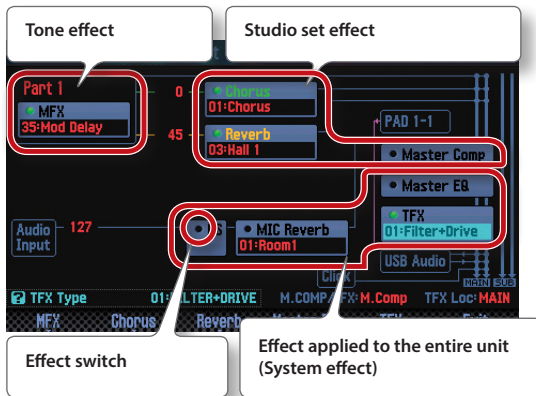

MEMO

From the STUDIO SET PLAY screen, you can also enter the EFFECTS EDIT screen by holding down the **[SHIFT]** button and pressing the **[3] (Effects Edit)** button.

3. Use the cursor buttons to select the effect switch, and use the dial to turn it on/off.

MEMO

For details on the parameters, refer to **"Parameter Guide"** (PDF).

NOTE

The effect settings that you edit are temporary. They will disappear when you turn off the power, or select another studio set or tone. If you want to keep the edited settings, save the tone, studio set, or system settings respectively.

- Saving a studio set (p. 45)
- Saving a tone (p. 48)
- Saving system settings (p. 97)

Parameters that can be edited in the EFFECTS EDIT screen

In the EFFECTS EDIT screen, you can also make the following settings.

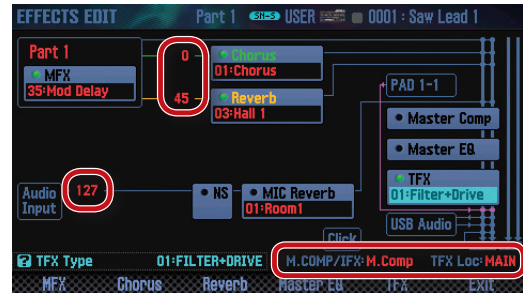

Parameter		Explanation
Studio set	Chorus Send Level	Specifies the depth of chorus.
	Reverb Send Level	Specifies the depth of reverb.
	M.COMP/IFX Select	Specifies whether to use the master compressor (Master Comp) or the insert effect (IFX).
System	Audio Input Level	Adjusts the input volume from the AUDIO INPUT jack.
	TFX Location	Selects whether the total effect is applied to the sound you play on the keyboard (MAIN) or on the input from the AUDIO INPUT jack (Input).

Editing the Effects of the Studio Set

Here's how to edit the effects of the studio set.

1. Access the EFFECTS EDIT screen (p. 52).
2. Press the effect button.

The STUDIO SET EFFECTS screen appears.

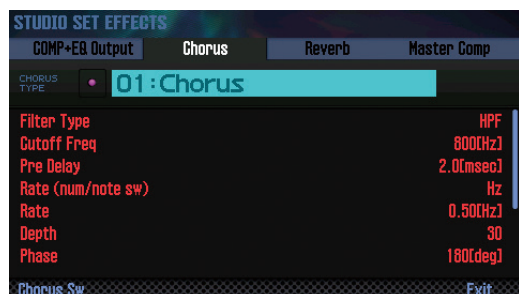

Button	Explanation
[3] (Chorus)	Edits the chorus settings.
[4] (Reverb)	Edits the reverb settings.
[SHIFT] + [3] (Comp+EQ Output)	Specifies the output destination of the drum part's compressor and equalizer. * This is valid only if the tone of the part specified by Drum Comp+EQ Assign is either PCMD or SN-D.
[SHIFT] + [7] (Master Comp)	Applies a final adjustment (compression) to the overall sound of the studio set. * When M.COMP/IFX Select is set to "Master Comp."
[SHIFT] + [7] (IFX)	Edits the insert effect settings. * When M.COMP/IFX Select is set to "IFX."

3. Use the cursor buttons to select a parameter, and use the dial to edit the value.

MEMO

For details on the parameters, refer to "Parameter Guide" (PDF).

Editing the Effects of the Tone

Here's how to edit the MFX and the compressor/equalizer of the drum part.

1. Access the EFFECTS EDIT screen (p. 52).
2. Press the effect button.

The TONE EDIT screen appears.

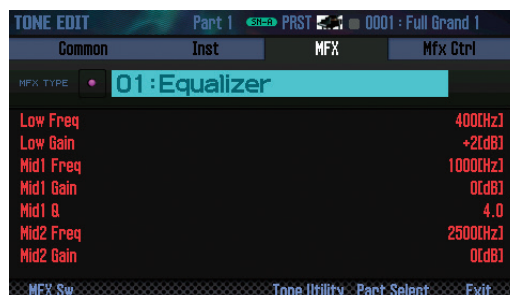

Button	Explanation
[2] (MFX)	Edits the MFX (multi-effect) settings.
[SHIFT] + [2] (Comp+EQ)	Edits the compressor and equalizer of the drum part. * This can be edited only if the part 10 drum kit is selected. * This is valid only if the tone of the part specified by Drum Comp+EQ Assign is either PCMD or SN-D.

3. Use the cursor buttons to select a parameter, and use the dial to edit the value.

MEMO

For details on the parameters, refer to "Parameter Guide" (PDF).

Editing the System Effects

Here's how to edit the system effects (effect applied to the entire unit).

1. Access the EFFECTS EDIT screen (p. 52).
2. Press the effect button.

The SYSTEM EFFECTS screen appears.

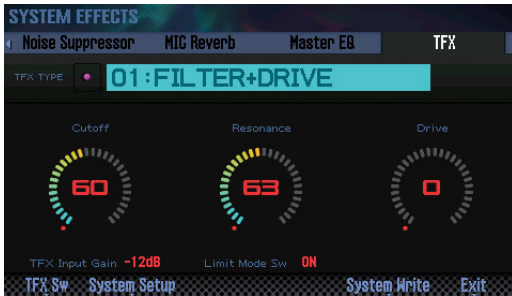

Button	Explanation
[5] (Master EQ)	Edits the equalizer that is applied to the entire sound engine of the FA.
[6] (TFX)	Edits the TFX (total effect) settings.
[SHIFT] + [4] (Input)	Specifies the input volume from the AUDIO INPUT jack.
[SHIFT] + [5] (NS)	Edits the noise suppressor settings.
[SHIFT] + [6] (MIC Reverb)	Applies reverb to the microphone or other device that's connected to the AUDIO INPUT jack.

3. Use the cursor buttons to select a parameter, and use the dial to edit the value.

MEMO

For details on the parameters, refer to "[Parameter Guide](#)" (PDF).

05: Sequencer (Creating Songs)

Explains how to use the sequencer to play, record and edit songs.

Playing Songs	56
Recording the Song.....	58
Editing the Song.....	63
Saving/Exporting a Song.....	74

Playing Songs

Selecting and Playing Songs

Here's how to select and play a song.

1. Press the **[SONG SELECT]** button.



The SONG SELECT screen appears.

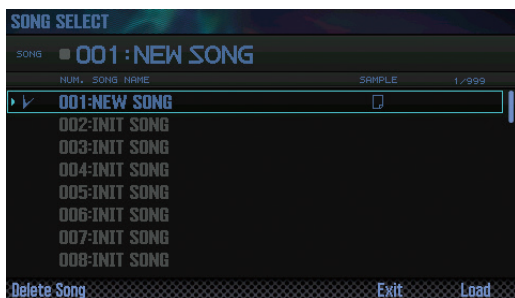

2. Turn the dial to select a song.
3. Press the **[7] (Load)** button.
A confirmation message appears.
4. Press the **[6] (OK)** button.
The song is selected.
5. Press the **[▶]** button.
The song starts playing.

Setting the Tempo of the Song

Here's how to set the tempo of the song.

1. Turn the **[TEMPO]** knob.



MEMO

- You can set the tempo by pressing the **[TAP]** button at the desired interval (tap tempo). Press the button three or more times at quarter-note intervals of the desired tempo.
- When you press the **[TAP]** button, the Tempo window appears. In this state, you can hold down the **[SHIFT]** button and turn the dial to adjust the value below the decimal point. If you press the **[6] (Click)** button, a click is sounded at the specified tempo. The click turns on/off each time you press the button.
- The specified tempo is saved in the song.

Button operations

Button	Explanation
[◀ ▶]	Returns the song position to the beginning.
[◀◀ ▶▶]	Rewinds the song.
[▶▶ ▶▶]	Fast-forwards the song.
[■]	Stops the song.

MEMO

The screen shows information about the song.

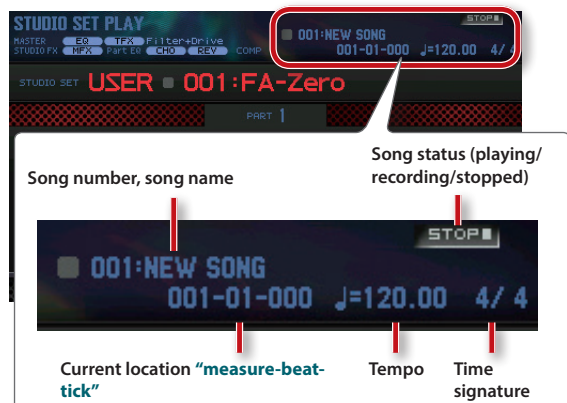

Looping the Song Playback

You can make the song play repeatedly over a specified region (loop playback).

1. Hold down the **[SHIFT]** button and press the **[LOOP]** button.



The Loop window appears.



2. Use the cursor buttons to select a parameter, and use the dial to edit the value.

Parameter	Value	Explanation
Start Point	001-	Specifies the beginning measure of the repeated region.
End Point	002-	Specifies the end measure of the repeated region. The location you specify here is not included in the repeated region.

* You can't set this beyond the length of the song.

You can use buttons to perform the following operations.

Button	Explanation
[4] (Set Start)	Sets the current measure of the song as the start measure.
[5] (Set End)	Sets the current measure of the song as the end measure.

3. Press the **[EXIT]** button.
4. Press the **[LOOP]** button to make it light.
5. Play back the song.
The playback repeats in the region you specified.
6. To cancel loop playback, press the **[LOOP]** button once again to make it go dark.

Recording the Song

The FA provides the following two ways for you to record a song.

Recording method	Explanation
Realtime recording	Realtime recording is a method in which your keyboard performance and controller operations are recorded just as you perform them.
Step recording	Step recording is a method in which you can enter notes and rests one by one. This method is typically used when you need precise timing, such as when entering notes for drums or bass.

Recording Workflow

Here's the workflow when recording a new song on this unit.

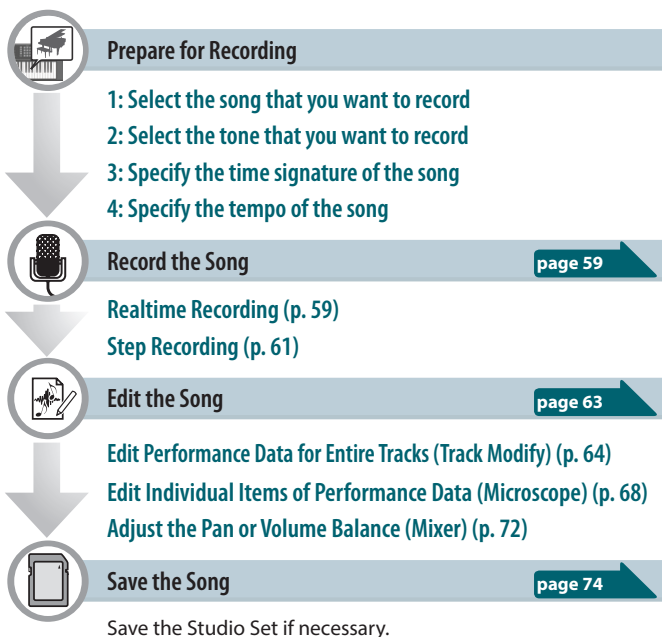

Prepare for Recording

Make the following preparations for recording.

1: Select the song that you want to record

Select the song that you want to record (p. 56).
If you want to record a new song, select a blank song (INIT SONG).

2: Select the tone that you want to record

Edit the studio set so that the tones you want to use for recording are selected on each track (p. 44).

So that the tones you selected for recording are remembered, it's a good idea to save the studio set (p. 45).

* If you don't save the studio set at the time of recording, playback will occur using the tones that were previously saved.

3: Specify the time signature of the song

The time signature is typically set to 4/4 time.

If you want to use any other time signature, set the desired time signature (p. 73).

4: Specify the tempo of the song

Specify the tempo of the song (p. 56).

About the SEQUENCER screen

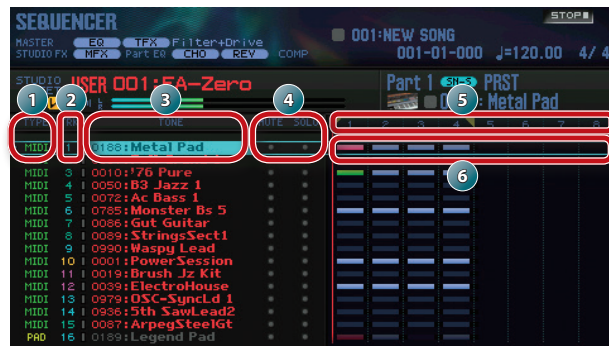

No.	Explanation	Page	
1	Track types	-	
	MIDI		Records keyboard performance data.
	PAD	Records pad performance data. One of the tracks 1–16 can be used as the pad track.	
2	Track number	-	
3	Tone number, tone name	-	
4	Mute and solo setting	p. 63	
5	Measure number	-	
6	Recorded data	-	
	* Note-off messages are not shown.		
			Note messages and other messages exist
			Messages other than note messages exist
		Note messages exist	

MEMO

You can hold down the [SHIFT] button and press the [7] () button to magnify the track settings display.

Realtime Recording

Here's how to do realtime recording.

1. Prepare for recording (p. 58).
2. Press the [SEQUENCER] button.



The SEQUENCER screen appears.

3. Use the cursor [▲][▼] buttons to select the track that you want to record.
4. Press the [●] button.



The [●] button blinks; the FA is in the record-standby condition. The Realtime Rec Standby window appears.



5. Make settings for realtime recording.

Use the cursor buttons to select a parameter, and use the dial to edit the value.

Parameter	Value	Explanation
COUNT IN		Selects the way in which recording is started.
	OFF	Recording begins immediately when you press the [▶] button.
	1 MEAS	When you press the [▶] button, a count begins from one measure before the recording start location; recording begins when the recording start location is reached.
	2 MEAS	When you press the [▶] button, a count begins from two measures before the recording start location; recording begins when the recording start location is reached.
	WAIT NOTE	Recording begins when you press the [▶] button, or when you press a key, press a pad, or press the hold pedal.
LOOP SWITCH	OFF, ON	Specifies whether loop recording will (ON) or will not (OFF) occur.
LOOP LENGTH	001–997	Specifies the length (number of measures) over which the loop will repeat.

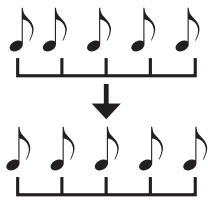
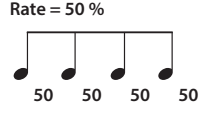
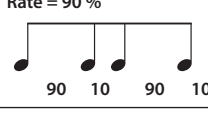
Parameter	Value	Explanation
INPUT QUANTIZE		Quantize is a function that automatically corrects inaccuracies in the timing at which you play the keyboard or the pads, tightening-up the rhythmic accuracy. You can apply the quantize function during realtime recording. This setting specifies whether quantize will be applied during recording.
	OFF	Quantize is not applied during recording.
	GRID	Grid quantize is applied during recording. Use this when you need accurate timing, such as for drums or bass. 
	SHUFFLE	Shuffle quantize is applied during recording. Use this when you want a bouncy rhythm such as shuffle or swing.
RESOLUTION		Specifies the note timing value at which quantization is applied. GRID: 1/32 (♩)–1/4 (♩) SHUFFLE: 1/16 (♩)–1/8 (♩)
STRENGTH	0–100 %	This setting is used with grid quantize. It specifies the degree to which your notes are moved to precise intervals of the note values specified by the RESOLUTION setting. If this is set to "100 %," the notes that you record are moved all the way to exact intervals of the specified RESOLUTION. With lower percentages, less correction is applied. If this is set to "0 %," the timing is not corrected at all.
RATE	0–100 %	This setting is used with shuffle quantize. If this is set to "50 %," the notes sound at equal intervals. Raising the value produces a bouncy feel as with dotted notes. Rate = 50 %  Rate = 90 % 
TEMPO REC	OFF, ON	Specifies whether tempo changes are (ON) or are not (OFF) recorded. If you want the tempo to change during the song, record those tempo changes in the tempo track (tempo recording). If tempo changes were already recorded, they are rewritten.
RHY PTH SYNC START	OFF, ON	Specifies whether the currently selected rhythm pattern is automatically played and recorded (ON) or not recorded (OFF) when recording starts.

MEMO

- If you're using loop play ([LOOP] button lit), the starting measure specified by Start Point is the recording start location.
- If you press the [6] (Click) button, a click is heard at the specified tempo. The click turns on/off each time you press the button.

Recording the Song

- Press the [▶] button or the [7] (Start) button.
Recording starts, and the Realtime Rec window appears.



MEMO

You can close the Realtime Rec window by pressing the [7] (Close) button or the [▶] button.
To see it again, press the [▶] button.

- To stop recording, press the [■] button.
The [●] button goes dark, and recording ends.

MEMO

You can undo (cancel) the recorded result (p. 62).

Removing Unwanted Data During Recording (Realtime Erase)

Realtime erase is a function that erases unwanted data during realtime recording. This function is particularly useful during loop recording, since it lets you erase data without stopping recording.

- Start realtime recording (p. 59).
- Press the [5] (Erase) button.

The Realtime Erase window appears.



- Erase unwanted data.

Operation	Explanation
Erase system exclusive messages	Press the [5] (Erase SysEx) button. The data is erased while you hold down the button.
Erase all data	Press the [6] (Erase All) button. The data is erased while you hold down the button.
Erase notes of a specific key	Press the corresponding key. The data is erased while you hold down the key.
Erase notes of a specific range of keys	Press the top and bottom key of the range. The data is erased while you hold down the keys.

- Press the [7] (Close) button.

The Realtime Erase window closes.

Auditioning Sounds or Phrases During Recording (Rehearsal Function)

During realtime recording, you can use the rehearsal function to temporarily prevent recording from occurring. When you're using loop recording, this gives you a convenient way to practice the next phrase you intend to play, before actually recording it.

- Start realtime recording (p. 59).
- Press the [6] (Rehearsal) button or the [●] button.

The [REC] indicator blinks, indicating that the rehearsal function is active. In this state, notes you play are not recorded.

- Press the [6] (Rehearsal) button or the [●] button.

Recording resumes.

Selecting the Performance Data to Record (Recording Select)

You can select the performance data that is recorded by realtime recording.

- In the Realtime Rec Standby window (p. 59), press the [5] (Rec Select) button.

The Recording Select window appears.

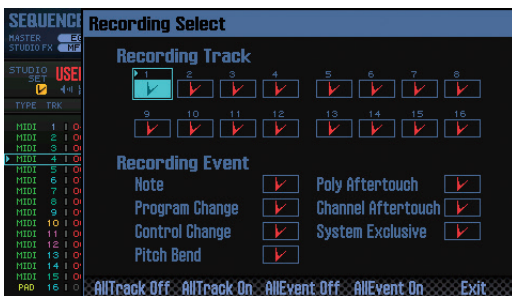

- Use the cursor buttons to select a parameter, and use the dial to edit the value.

Items with a check mark (✓) are recorded; items without a check mark are not recorded.

For details on the recorded data, refer to "Performance data in a track" (p.68).

Button	Explanation
[3] (AllTrack Off)	Clears check marks from all tracks.
[4] (AllTrack On)	Applies check marks to all tracks.
[5] (AllEvent Off)	Clears check marks from all event types.
[6] (AllEventk On)	Applies check marks to all event types.

- Press the [7] (Exit) button.

The Recording Select window closes.

Step Recording

Here's how to record using step recording.

1. Prepare for recording (p. 58).
2. Press the [SEQUENCER] button.



3. Use the cursor [\blacktriangle] [\blacktriangledown] buttons to select the track that you want to record.
4. In the SEQUENCER screen (p. 59), press the [\bullet] button.



The [\bullet] button blinks; the sequencer is in record standby condition.

The Realtime Rec Standby window appears.



5. Press the [4] (Step Rec) button.

The Step Rec Standby window appears.



6. Use the dial or the [DEC] [INC] buttons to specify the start location for step recording.

* If the song contains no recorded data at all, you can't specify the start location.

7. Press the [7] (Start) button.

The STEP RECORDING screen appears.

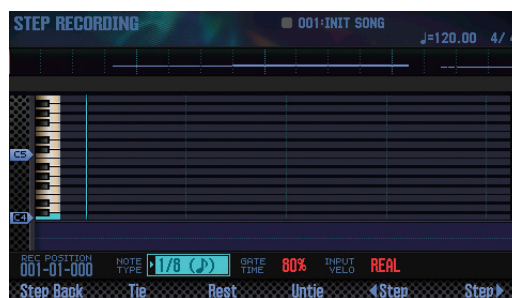

8. Make settings for the notes that you want to enter.

Use the cursor buttons to select a parameter, and use the dial to edit the value.

Parameter	Value	Explanation
NOTE TYPE	1/64 (♩)– 2/1 (♩♩)	Specifies the length of the notes you want to enter, as a note value symbol. The note type is the length from one note-on to the next note-on.
GATE TIME	1–100 %	Specifies the gate time as a proportion of the note type. The gate time is the length from note-on to note-off. Use a low value to produce staccato, or a high value to produce tenuto or slurs. Normally you'll use a setting of approximately "80 %."
INPUT VELO	REAL, 1–127	Specifies the force with which the key is played. If you want the velocity of your actual keystroke to be used, choose "REAL." Otherwise specify the desired velocity, using p (piano) = 60, mf (mezzo forte) = 90, and f (forte) = 120 as approximate guidelines.

9. Enter notes.

1. Press the [6] (◀Step) button or the [7] (Step▶) button to move to the location at which you want to enter a note.
2. Play a note on the keyboard or press a pad.

You can use buttons to perform the following operations.

Button	Explanation
[2] (Step Back)	Cancels the previously-entered note.
[3] (Tie)	Extends the length of the previously-entered note by the current note type setting (tie).
[4] (Rest)	Enters a rest. Set the note type to the length of the rest that you want to enter.
[5] (Untie)	Cancels the previously-entered tie.
[6] (Step ◀)	Moves the input location backward by the length of the current note type.
[7] (Step ▶)	Moves the input location forward by the length of the current note type.
[▲] [▼]	Shift the displayed pitch range up or down.

Recording the Song

- Repeat steps 8 and 9 as necessary.
- To stop recording, press the [■] button.
The [●] button goes dark, and step recording ends.

MEMO



















You can undo (cancel) the recorded result (p. 62).

How note value and gate time are related

The following table shows how note value and gate time are related.

On the FA's sequencer, the TPQN (ticks per quarter note) resolution is 480.

This means that a quarter note has a gate time of 480 ticks.

Note	Gate time	Note	Gate time
	30		240
	40		320
	45		360
	60		480
	80		640
	90		720
	120		960
	160		1920
	180		3840

MEMO

The gate time that is recorded during step recording is the original gate time value multiplied by the GATE TIME value. For example if GATE TIME is set to 80 % and you enter a quarter note, the gate time is $480 \times 0.8 = 384$.

Canceling a Recording or Edit (Undo/Redo)

You can cancel a recording or editing operation to return to the previous state (Undo). You can also cancel an Undo operation (Redo).

Returning to the previous state (Undo)

- In the SEQUENCER screen (p. 59), hold down the [SHIFT] button and press the [6] (Undo) button.

The Undo operation is executed, cancelling the recording or editing operation that you just performed.

Canceling the Undo operation (Redo)

- In the SEQUENCER screen (p. 59), hold down the [SHIFT] button and press the [6] (Redo) button.

The Redo operation is performed, cancelling the Undo operation that you just performed.

Editing the Song

Here's how to edit a song that you recorded.

Specifying the Sound Engine Played by Each Track

You can specify the output destination of each track. This lets you play back a song using an external sound module in addition to the FA's internal sound engine.

1. In the SEQUENCER screen (p. 59), hold down the [SHIFT] button and press the [3] (Song Util) button.
2. Move the cursor to "Track Settings" and press the [7] (Select) button.
3. Use the cursor ([▲][▼]) buttons and the dial to change the settings.

Value	Explanation
INT	The internal sound engine of the FA is played.
EXT	An external sound module connected to the MIDI OUT connector is played.
BOTH	Both the internal sound engine and the external sound module are played.
OFF	The track does not output data.

4. Press the [7] (Exit) button.

Muting a Part's Performance (MUTE)

When playing a song, you can mute (silence) the performance of a specific part.

1. Access the SEQUENCER screen (p. 59).
2. Use the cursor buttons to move the cursor to "MUTE" of the track that you want to mute.



3. Use the dial or the [DEC] [INC] buttons to turn Mute on/off.

MEMO

You can use the pads to turn Mute on/off (p. 84).

Sounding One Part by Itself (SOLO)

When playing back a song, here's how you can listen to the current part (the currently selected part) by itself.

1. Access the SEQUENCER screen (p. 59).
2. Use the cursor buttons to move the cursor to "SOLO" of the track that you want to solo.

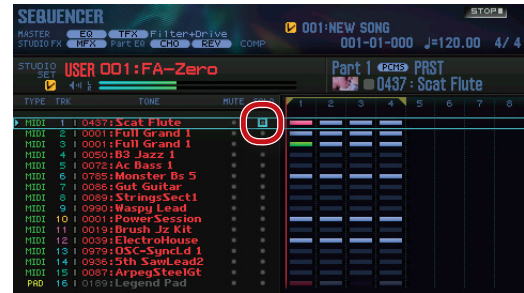

3. Use the dial or the [DEC] [INC] buttons to turn Solo on/off.

MEMO

You can use the pads to turn Solo on/off (p. 84).

Edit Performance Data for Entire Tracks (Track Modify)

Basic Procedure for Track Modify

Use the Track Modify functions to edit the performance data in specified regions of measures.

1. In the SEQUENCER screen (p. 59), hold down the [SHIFT] button and press the [4] (Track Modify) button.

The TRACK MODIFY MENU window appears.

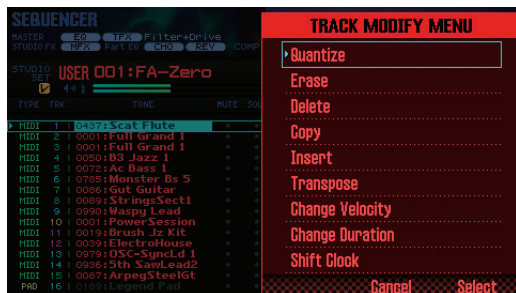

2. Use the cursor buttons to select an item, and press the [ENTER] button.
3. Use the cursor buttons to select a parameter, and use the dial to change the setting.
4. Press the [7] (Execute) button.

A confirmation message appears.

If you decide to cancel, press the [7] (Cancel) button.

5. Press the [6] (OK) button.

The edit operation is executed.

MEMO

You can undo (cancel) the result of editing (p. 62).

Item	Parameter	Value	Explanation
Correcting the Song's Timing (Quantize)			
This function quantizes an already-recorded song.			
MEMO			
Quantize corrects only the timing at which you press a key (note-on) and the timing at which you release a key (note-off); it does not correct the timing of other performance data. This means that you may experience unintended results if performance data such as pitch bend or modulation is shifted away from the notes to which it originally applied.			
Quantize	TRACK	Track All	Tracks 1–16
		Track1–Track16	The specified track
	MEASURE	001–END	Specifies the range of measures that will be quantized.
	QUANTIZE TYPE	GRID	Specifies how quantization will occur. Grid quantization is applied during editing. Use this when you want accurate timing, such as for drums or bass.
		SHUFFLE	Shuffle quantization is applied during editing. Use this when you want to give the rhythm a sense of shuffle or swing.
	Resolution	GRID: 1/32 (♩)–1/4 (♩) SHUFFLE: 1/16 (♩)–1/8 (♩)	Specifies the quantization timing as a note value. If you're using grid quantize, choose the shortest note value that occurs in the region that you're quantizing. * If you apply shuffle quantize to performance data that has significant discrepancies in timing, you might not obtain the result you expect. In this case, first apply grid quantize to the original performance data so that it is aligned according to the musical score, and then apply shuffle quantize to obtain the desired effect.



For details on the basic procedure for Track Modify functions, refer to p. 64.

Item	Parameter	Value	Explanation
Quantize	Strength	0–100 %	Use this setting when applying grid quantize. It specifies how greatly the notes will be moved toward intervals of the note value specified by Grid Resolution. If this is set to “100 %” , notes will be moved all the way to precise intervals of the Grid Resolution timing. With lower values, less timing correction is applied to the notes. With a setting of “0 %” , no timing correction is applied.
	Rate	Use this setting when applying shuffle quantize. If this is set to 50 %, notes will sound at equal spacing. As this value is increased, you obtain a bouncy effect as with dotted notes.	<div style="display: flex; justify-content: space-around;"> <div style="text-align: center;"> <p>Rate = 50 %</p> </div> <div style="text-align: center;"> <p>Rate = 90 %</p> </div> </div>
	RANGE MIN, RANGE MAX	Specify the range of notes that are quantized.	

Erasing Unwanted Performance Data (Erase)

This function erases all performance data from the specified region. Since the erased performance data is replaced by rests, the measures themselves remain.

Erase	TRACK	Specifies the track(s) from which data is erased.		
		Track All	Tracks 1–16 and the tempo track	
		Track1–Track16	The specified track	
		Tempo	The tempo track	
	MEASURE	001–END	Specifies the region of measures from which data is erased.	
	EVENT	Selects the performance data that is erased. * “Tempo” can be selected only if TRACK is set to “Tempo.”		
		ALL	All performance data	
		Note	Note messages	
		Program Change	Program change messages	
		Control Change	Control change messages	
		Pitch Bend	Pitch bend messages	
		Poly Aftertouch	Polyphonic aftertouch	
		Channel Aftertouch	Channel aftertouch messages	
System Exclusive		System aftertouch messages		
Tempo	Tempo data			
Range Min, Range Max	If EVENT is set to “Note,” “Poly Aftertouch,” “Control Change,” or “Program Change,” you can specify the range of values. Range Min specifies the minimum value of the range, and Range Max specifies the maximum value of the range. MEMO <ul style="list-style-type: none"> If you want to erase all notes or all polyphonic aftertouch data, set Range Min to “C1” and Range Max to “G9.” If you want to erase “C4,” set both Range Min and Range Max to “C4.” If you want to erase from “C3” through “C4,” set Range Min to “C3” and Range Max to “C4.” If you want to erase all controller numbers, set Range Min to “0” and Range Max to “127.” If you want to erase all program numbers, set Range Min to “1” and Range Max to “128.” If you want to erase number 4, set both Range Min and Range Max to “4.” If you want to erase numbers 3 through 14, set Range Min to “3” and Range Max to “14.” 			

Deleting Unwanted Measures (Delete)

This function deletes the performance data from the specified region, moving subsequent measures toward the beginning of the song to close the gap. The length of the song is shortened according to the number of measures in the deleted region.

Delete	TRACK	Specifies the track(s) from which measures are deleted.	
		Track All	Tracks 1–16, the time signature track, and the tempo track
		Track1–Track16	The specified track
		Tempo	The tempo track
MEASURE	001–END	Specifies the range of measures that are deleted.	

Copying Performance Data (Copy)

This function copies the performance data of the specified region. This is convenient when you want to use a certain phrase repeatedly.

Copy	SRC TRACK	Specifies the copy-source track(s).	
		ALL	Tracks 1–16, the time signature track, and the tempo track
		Track1–Track16	The specified track
		TEMPO	The tempo track
	SRC MEASURE	001–END	Specifies the region of copy-source measures.



Item	Parameter	Value	Explanation
Copy	DEST TRACK	Specifies the copy-destination track.	
		<p>MEMO</p> <ul style="list-style-type: none"> • If SRC TRACK is set to "Track All," the DEST TRACK is fixed at "Track All." • If SRC TRACK is set to "Tempo," the DEST TRACK is fixed at "Tempo." 	
		Track All	Tracks 1–16, the time signature track, and the tempo track
		Track1–Track16	The specified track
		Tempo	The tempo track
	DEST MEASURE	001–END	Specifies the beginning measure of the copy-destination. If you want the copy-destination to follow the last measure of the song, set this to "END."
	COPY MODE	Specifies whether you want the performance data at the copy-destination to be preserved.	
		MIX	The copied data is combined with the performance data currently existing at the copy-destination.
REPLACE		The performance data currently existing at the copy-destination is erased, and replaced by the copied data.	
COPY TIMES	1–998 (maximum)	Specifies the number of times that the data is copied.	
EVENT	Selects the performance data that is copied. For details, refer to "EVENT" (p.65).		
Range Min, Range Max	For details, refer to "Range Min, Range Max" (p.65).		

Inserting Blank Measures (Insert)

This function inserts new, blank measures at the specified location. Since you can specify the time signature of the blank measures that are inserted, this is a convenient way to insert phrases of an alternate time signature in the middle of a song.

Insert	TRACK	Specifies the track(s) into which blank measures are inserted.	
		Track All	Tracks 1–16, the time signature track, and the tempo track
		Track1–Track16	The specified track
		Tempo	The tempo track
	MEASURE	001–END	Specifies the starting measure at which the measures are inserted.
LENGTH	001–ALL	Specifies the length of measures at which the measures are inserted.	

Transposing (Transpose)

This function transposes the notes of the specified region in a range of ± 24 semitones. Use this if you want to change key during the song, or to transpose the entire song.

Transpose	TRACK	Specifies the track(s) that will be transposed.	
		Track All	Tracks 1–16 (Track 10 is not transposed.)
		Track1–Track16	The specified track
	MEASURE	001–END	Specifies the range of measures that are transposed.
NOTE MIN, NOTE MAX	Specify the range of notes that are transposed. For example if you want to transpose notes in the range of C3 through C4, set NOTE MIN to "C3" and NOTE MAX to "C4."		

Changing the Velocity (Change Velocity)

This function changes the keyboard dynamics (velocity) in the specified region.

Change Velocity	TRACK	Specifies the track(s) in which velocity is changed.	
		Track All	Tracks 1–16
		Track1–Track16	The specified track
	MEASURE	001–END	Specifies the range of measures in which velocity is changed.
	VALUE	-99–+99	Specifies the amount by which the recorded velocity is changed.
NOTE MIN, NOTE MAX	Specify the range of notes whose velocity is changed. For example if you want to change the velocity of notes in the range of C3 through C4, set NOTE MIN to "C3" and NOTE MAX to "C4."		



For details on the basic procedure for Track Modify functions, refer to p. 64.

Item	Parameter	Value	Explanation
Change Duration	Changing the Duration of the Notes (Change Duration)		
	This function changes the duration (the time from note-on to note-off) of the notes in the specified region. You can use this conversion to give the performance a more staccato or tenuto feel.		
	TRACK	Specifies the track(s) in which the note duration is changed.	
		Track All	Tracks 1–16
		Track1–Track16	The specified track
MEASURE	001–END	Specifies the range of measures in which the note duration is changed.	
VALUE	-960–+960	Specifies the amount by which the note duration is changed.	
NOTE MIN, NOTE MAX	Specifies the range of pitches whose note duration is changed. For example if you want to change the duration of notes in the range of C3 through C4, set NOTE MIN to “C3” and NOTE MAX to “C4.”		
Shift Clock	Moving Performance Data Forward or Backward (Shift Clock)		
	This function moves the timing of performance data in the specified region forward or backward in units of ticks. By slightly moving the performance data you can give the performance a “rushing” or “dragging” feel.		
	* If the Shift Clock function would cause data to be moved beyond the beginning of the song, such data is moved to the beginning of the song. If this function causes data to be moved beyond the end of the song, the necessary number of measures are added. The added measures have the same time signature as the immediately preceding measure.		
	TRACK	Specifies the track(s) that are moved.	
		Track All	Tracks 1–16 and the tempo track
		Track1–Track16	The specified track
		Tempo	The tempo track
MEASURE	001–END	Specifies the region of measures in which the performance data is shifted in units of ticks.	
VALUE	-960–+960	Specifies the number of ticks by which the data is shifted.	
EVENT	Selects the performance data that is shifted. For details, refer to “EVENT” (p.65).		
Range Min, Range Max	For details, refer to “Range Min, Range Max” (p.65).		

- Overview
- Performing
- Performance Functions
- Editing
- Sequencer (Creating Songs)
- Sampler
- Pads
- DAW
- Settings
- Appendix

Editing Individual Events of Performance Data (Microscope)

Microscope lets you edit individual events of performance data, such as the MIDI messages or tempo data recorded in a song.

1. In the SEQUENCER screen (p. 59), hold down the [SHIFT] button and press the [5] (Microscope) button.

The MICROSCOPE screen appears.

MEMO

You can Undo (cancel) the result of your editing (p. 62).

About the MICROSCOPE screen



No.	Explanation
1	Location of the performance data (Measure (Meas) – Beat (Beat) – Tick (Tick))
2	Performance data
3	Data for the parameter at the cursor location

Function button operations

Button	Explanation	Page
[2] (Create)	Inserts data.	p. 69
[3] (Erase)	Erases data.	p. 69
[4] (Move)	Moves data.	p. 70
[5] (Copy)	Copies data.	p. 70
[6] (Paste)	Pastes previously-copied data.	
[7] (View)	Selects the track to edit. You can also choose to view only specific performance data.	p. 69
[SHIFT] + [7] (Microscope)	Switches the piano-roll display type.	-

Other controllers

Controller	Explanation
Cursor	Selects the performance data or parameter to edit.
Dial	Edits the value.
[DEC] [INC]	
[ENTER]	Transmits the selected performance data. In the case of a note message, the note is sounded.

Performance data in a track

A track can record the following performance data.

Performance data	Explanation
Note	<p>Note messages</p> <p>These MIDI messages represent musical notes. From the left, the parameters are the note number that indicates the name of the note (Note Number), the on-velocity that specifies the force with which the key is struck (On Velocity), the duration that specifies the length of the note (Duration), and the off-velocity that specifies how quickly the key was released (Off Velocity).</p>
Program Change	<p>Program change messages</p> <p>These MIDI messages switch sounds. Specify the program number (PC#) to select a sound.</p>
Control Change	<p>Control change messages</p> <p>These MIDI messages apply various effects such as modulation and expression. Use the controller number (CC#) to select the function, and specify how deeply it will apply (Value).</p>
Pitch Bend	<p>Pitch bend messages</p> <p>These MIDI messages vary the pitch. The value (Value) specifies the amount of pitch change.</p>
Poly Aftertouch	<p>Polyphonic aftertouch</p> <p>These MIDI messages apply aftertouch to individual keys. From the left, the parameters are the note number that specifies the key (Note Number), and the value that specifies how deeply aftertouch is applied (Value).</p>
Channel Aftertouch	<p>Channel aftertouch messages</p> <p>These MIDI messages apply aftertouch to an entire MIDI channel. The value (Value) specifies how deeply aftertouch is applied.</p>
System Exclusive	<p>System exclusive messages</p> <p>These MIDI messages control settings that are unique to the FA, such as sound and tonal character. Insert the data between "F0" and "F7."</p>
Tempo Change	<p>Tempo change</p> <p>This is tempo data recorded in the tempo track. The song plays back according to these tempo change values (Value).</p>
Time Signature	<p>Time signature</p> <p>This is time signature data recorded in the time signature track.</p>

Selecting the Track to Edit / Viewing Specific Performance Data (View)

Here's how you can select the track to edit, and view just the performance data that you want to see.

1. In the MICROSCOPE screen (p. 68), press the [7] (View) button.

The View Select window appears.



2. Use the cursor buttons to select a parameter, and use the dial to edit the setting.

Selecting the track to edit

Move the cursor to "Track Select," and select the track that you want to edit.

Viewing specific performance data

Types of data with a check mark () are shown; clear the check mark for data types that you don't want to see.

For more about performance data, refer to "Performance data in a track" (p.68).

Button	Explanation
[5] (All Off)	Clears check marks from all types.
[6] (All On)	Applies check marks to all types.

3. Press the [7] (Close) button.

The View Select window closes.

Inserting Performance Data (Create)

Here's how to insert new performance data at a desired location in the track.

1. In the MICROSCOPE screen (p. 68), press the [2] (Create) button.

The Create Event window appears.



2. Use the cursor [▲][▼] buttons to select the performance data that you want to insert.

MEMO

- For more about performance data, refer to "Performance data in a track" (p.68).
- System Exclusive data can be inserted only into track 1.

3. Press the [7] (Execute) button.

The performance data is inserted.

4. Edit the values of the performance data.

Erasing Performance Data (Erase)

Here's how to erase a specific item of performance data.

- * You can't erase the time signature that's at the beginning of the time signature track.

1. Access the MICROSCOPE screen (p. 68).
2. Use the cursor [▲][▼] buttons to move the cursor to the performance data that you want to erase.
3. Press the [3] (Erase) button.

The performance data is erased.

Moving Performance Data (Move)

Here's how to move a specific item of performance data.

- * You can't move data in the tempo track or the time signature track.

1. Access the MICROSCOPE screen (p. 68).
2. Use the cursor [▲][▼] buttons to move the cursor to the performance data that you want to move.

MEMO

If you want to move multiple items of performance data, hold down the [SHIFT] button and use the cursor [▲][▼] buttons.

3. Press the [4] (Move) button.

The Move Event window appears.



4. Specify the move-destination location.

Move the cursor to the value that you want to edit, and use the dial to edit the value.

5. Press the [7] (Execute) button.

The performance data is moved.

Copying/Pasting Performance Data (Copy/Paste)

Here's how to copy and paste performance data to a specified location. This is convenient when you want to use the same performance data several times.

- * You can't copy data of the tempo track or time signature track.

1. Access the MICROSCOPE screen (p. 68).
2. Use the cursor [▲][▼] buttons to move the cursor to the performance data that you want to copy.

3. Press the [5] (Copy) button.

The performance data is copied.

4. Press the [6] (Paste) button.

The Paste Event window appears.



5. Specify the copy-destination location.

Move the cursor to the value that you want to edit, and use the dial to edit the value.

6. Press the [7] (Execute) button.

The performance data is pasted.

Changing the Tempo During a Song

If you want the tempo to change during a song, you can insert new tempo change data into the tempo track. Following the location at which you insert the tempo change, the song plays at that tempo.

MEMO

If you want to change the tempo gradually to create a ritardando or accelerando, it is convenient to use tempo recording (p. 59).

1. Select the tempo track (p. 69).
2. Press the [2] (Create) button.

The Create Event window appears, and “Tempo Change” is selected.

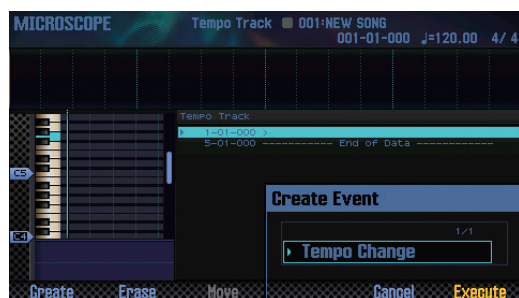

3. Press the [7] (Execute) button.
4. Specify the insert-destination location.
Move the cursor to the value that you want to edit, and use the dial to edit the value.
5. Press the [7] (Execute) button.
A tempo change is inserted.
6. Edit the tempo change value.

Changing the Time Signature During a Song

If you want the time signature to change during a song, you can insert a new time signature. Following the location at which you insert the time signature, the song plays at that time signature.

* You can't change the time signature in the middle of a measure. You must change the time signature at the beginning of a measure.

1. Select the time signature track (p. 69).
2. Press the [2] (Create) button.

The Create Event window appears, and “Time Signature” is selected.

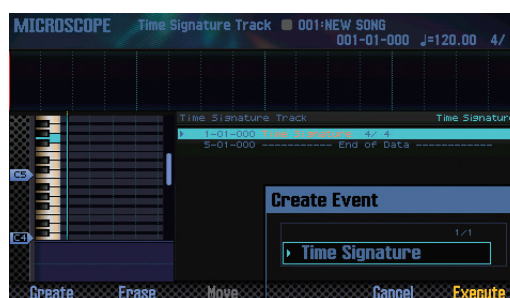

3. Press the [7] (Execute) button.
4. Specify the insert-destination location.
Move the cursor to the value that you want to edit, and use the dial to edit the value.
5. Press the [7] (Execute) button.
The time signature is inserted.
6. Edit the time signature value.

Adjusting the Pan and Volume Balance (Mixer)

In the MIXER screen you can adjust the song's pan and volume balance for each track.

* The parameters that you edit in the MIXER screen are saved in the studio set. If you want to keep the changes you make in the MIXER screen, save the studio set (p. 45).

1. In the SEQUENCER screen (p. 59), hold down the [SHIFT] button and press the [2] (Mixer) button.

The MIXER screen appears.

MEMO

You can also access the MIXER screen by holding down the [SHIFT] button and pressing the [SEQUENCER] button.

2. Use the cursor buttons to select a parameter, and use the dial to edit the value.

About the MIXER screen



No.	Explanation	Page
1	Part number	-
2	Mute and solo settings	p. 63
3	Chorus (Chorus Send Level) setting	p. 52
4	Reverb (Reverb Send Level) setting	p. 52
5	Pan setting	p. 44
6	Volume (Level) setting	p. 44

Erasing the Song in the Temporary Area (Song Clear)

Here's how to erase the performance data that's in the temporary area (p. 14).

1. In the SEQUENCER screen (p. 59), hold down the [SHIFT] button and press the [3] (Song Util) button.

The SONG UTIL MENU window appears.

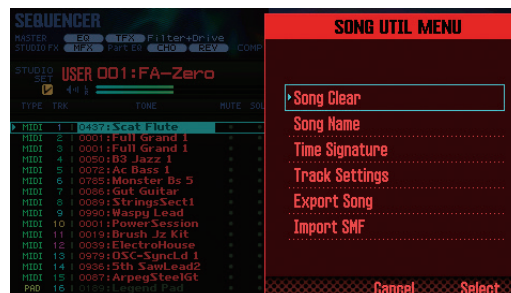

2. Move the cursor to "Song Clear," and press the [7] (Select) button.

A confirmation message appears.

If you decide to cancel, press the [7] (Cancel) button.

3. Press the [6] (OK) button.

The performance data is erased.

Assigning a Name to the Song (Song Name)

Here's how you can assign a name to the song.

1. Access the SONG UTIL MENU window.
2. Move the cursor to "Song Name" and press the [7] (Select) button.

The SONG NAME window appears.



3. Specify the desired name (p. 45).

MEMO

If you want to keep the song, save it on an SD card (p. 74).

Specifying the Song's Time Signature (Time Signature)

Here's how to specify the time signature of the song.

1. Access the SONG UTIL MENU window (p. 72).
2. Move the cursor to "Time Signature," and press the [7] (Select) button.

The Time Signature window appears.



3. Use the cursor buttons and the dial to specify the time signature.
4. Press the [7] (Execute) button.

MEMO

You can also change the time signature during the song (p. 71).

Deleting a Song (Delete Song)

Here's how to delete a previously-saved song.

1. Press the [SONG SELECT] button.
The SONG SELECT window appears.

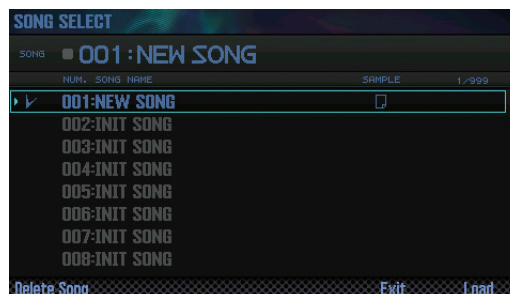

2. Turn the dial to select the song that you want to delete.
3. Press the [2] (Delete Song) button.

A confirmation message appears.

If you decide to cancel, press the [7] (Cancel) button.

MEMO

If the song contains sample data, the Delete Song Menu window appears.

Use the dial or the [DEC] [INC] buttons to select the data that you want to delete, and press the [7] (Select) button.

Parameter	Explanation
Song Only	Deletes only the song data.
Song With Sample	Deletes the song and sample data.

4. Press the [6] (OK) button.
The song is deleted.

Saving/Exporting a Song

Save the Song

A song that you record is temporary. It disappears if you turn off the power or select another song. If you want to keep a song that you record, save the song to an SD card.

NOTE

- When you execute the Save operation, any existing data in the save-destination is overwritten.
- In addition to the performance data, a song also contains information about the studio set. This means that the song playback is affected if you edit the studio set or the tones that are used by a song.

1. Press the [WRITE] button.

The WRITE MENU screen appears.



2. Move the cursor to "Song" and press the [7] (Select) button.

The SAVE SONG window appears.

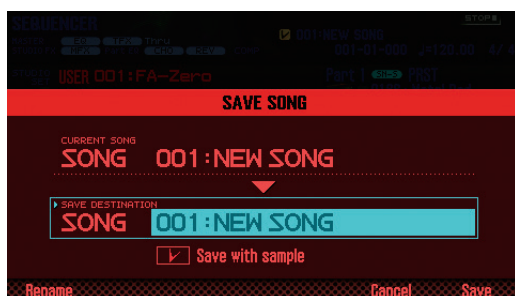

3. Use the dial or the [DEC] [INC] buttons to specify the save-destination.

MEMO

If you want to save the song and samples together, add a check mark to "Save with sample."

4. Press the [2] (Rename) button and assign a name to the song (p. 45).

5. Press the [7] (Save) button.

A confirmation message appears.

If you decide to cancel, press the [7] (Cancel) button.

6. Press the [6] (OK) button.

The song is saved.

- * If the song contains numerous samples, it may take several minutes for saving to be completed.

Exporting Tracks as Individual WAV Format Files (Multi-track Export)

You can export all tracks as individual WAV format files in a single operation.

- * The pad track is not exported.

1. Access the SONG UTIL MENU window (p. 72).

2. Move the cursor to "Export Song" and press the [7] (Select) button.

The SONG EXPORT MENU window appears.



MEMO

You can also access the SONG EXPORT MENU window from the UTILITY screen (p. 94).

3. Move the cursor to "WAV (Multitrack)" and press the [7] (Select) button.

The EXPORT WAV (MULTI TRACK) window appears.

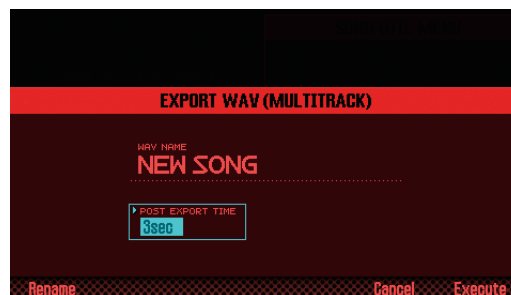

4. Specify the "POST EXPORT TIME" as desired.

Value	Explanation
0-30 sec	In some cases, the reverberant decay at the end of the exported WAV files might be cut off. If so, increase this value so that the decay will not be cut off.

6. Press the [2] (Rename) button and assign a name to the file (p. 45).

7. Press the [7] (Execute) button.

A confirmation message appears.

If you decide to cancel, press the [7] (Cancel) button.

8. Press the [6] (OK) button.

The song plays back, and export begins.

The exported WAV files are saved in the SD card's "EXPORT TRACK" folder.

- * If there is an identically-named file in the export-destination, a message asks "Overwrite?" Press the [6] (OK) button if you want to overwrite, or press the [7] (Cancel) button if you decide to cancel.

NOTE

Never turn off the power while the export is in progress.

Exporting a Two-Channel Mix in WAV Format

You can export a two-channel (stereo) mix in WAV format.
 * The pad track is not exported.

1. Access the SONG UTIL MENU window (p. 72).
2. Move the cursor to “Export Song” and press the [7] (Select) button.
3. Move the cursor to “WAV (STEREO MIX)” and press the [7] (Select) button.

The EXPORT WAV (STEREO MIX) window appears.

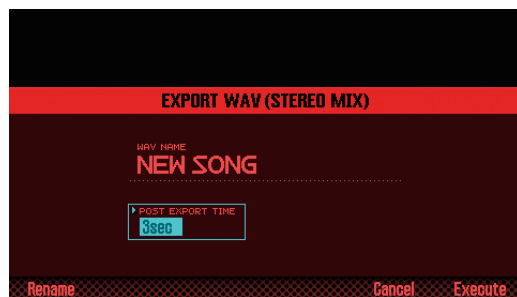

4. Specify the “POST EXPORT TIME” as desired.

Value	Explanation
0–30 sec	In some cases, the reverberant decay at the end of the exported WAV files might be cut off. If so, increase this value so that the decay will not be cut off.

5. Press the [2] (Rename) button and assign a name to the file (p. 45).
6. Press the [7] (Execute) button.
 A confirmation message appears.
 If you decide to cancel, press the [7] (Cancel) button.
7. Press the [6] (OK) button.

The song plays back, and export begins.
 The exported WAV files are saved in the SD card’s “EXPORT STEREO MIX” folder.

* If there is an identically-named file in the export-destination, a message asks “Overwrite?” Press the [6] (OK) button if you want to overwrite, or press the [7] (Cancel) button if you decide to cancel.

NOTE

Never turn off the power while the export is in progress.

MEMO

You can also access the SONG EXPORT MENU window from the UTILITY screen (p. 94).

Exporting the Song in SMF Format

Here’s how to export the song in SMF format.

1. Access the SONG UTIL MENU window (p. 72).
2. Move the cursor to “Export Song” and press the [7] (Select) button.
3. Move the cursor to “SMF” and press the [7] (Select) button.

The EXPORT SMF window appears.

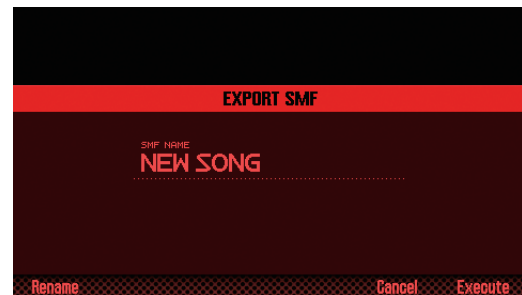

4. Press the [2] (Rename) button and assign a name to the file (p. 45).
5. Press the [7] (Execute) button.
 A confirmation message appears.
 If you decide to cancel, press the [7] (Cancel) button.
6. Press the [6] (OK) button.

The exported SMF file is saved in the SD card’s “EXPORT SMF” folder.

* If there is an identically-named file in the export-destination, a message asks “Overwrite?” Press the [6] (OK) button if you want to overwrite, or press the [7] (Cancel) button if you decide to cancel.

NOTE

Never turn off the power while the export is in progress.

MEMO

You can also access the SONG EXPORT MENU window from the UTILITY screen (p. 94).

Exporting Samples in WAV Format

You can export all samples of the song in WAV format.

1. Access the SONG UTIL MENU window (p. 72).
2. Move the cursor to “Export Song” and press the [7] (Select) button.
3. Move the cursor to “All Samples” and press the [7] (Select) button.

A confirmation message appears.

If you decide to cancel, press the [7] (Cancel) button.

4. Press the [6] (OK) button.

The exported WAV files are saved in the SD card’s “EXPORT SAMPLE” folder.

- * If there is an identically-named file in the export-destination, a message asks “Overwrite?” Press the [6] (OK) button if you want to overwrite, or press the [7] (Cancel) button if you decide to cancel.

NOTE

Never turn off the power while the export is in progress.

MEMO

- You can also access the SONG EXPORT MENU window from the UTILITY screen (p. 94).
- You can export samples individually (p. 82).

Importing an SMF as a Song

You can import an SMF into a song, and handle the imported SMF as a song.

MEMO

- Before you continue, copy the SMF from your computer into the “IMPORT” folder of the SD card.
- A maximum of 200 files in the “IMPORT” folder can be recognized.

1. Access the SONG UTIL MENU window (p. 72).
2. Move the cursor to “Import SMF” and press the [7] (Select) button.

The SONG IMPORT screen appears.

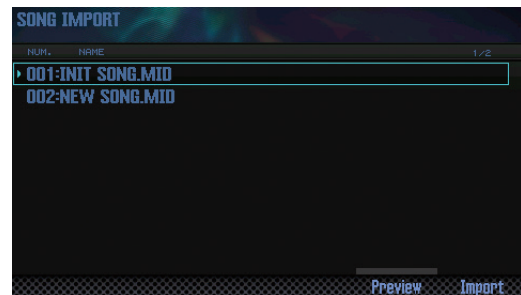

MEMO

You can press the [6] (Preview) button to audition the selected SMF.

3. Use the dial or the [DEC] [INC] buttons to select the SMF that you want to import, and press the [7] (Import) button.

A confirmation message appears.

If you decide to cancel, press the [7] (Cancel) button.

4. Press the [6] (OK) button.

The SMF is imported.

06: Sampler

Explains sampling and sample editing.

Playing Samples	78
Sampling.....	79
Editing a Sample.....	81

Playing Samples

Selecting/Playing Samples

You can play samples by pressing the pads. The FA lets you assign samples to the 16 pads and play them.

1. Press a pad [1]–[16].

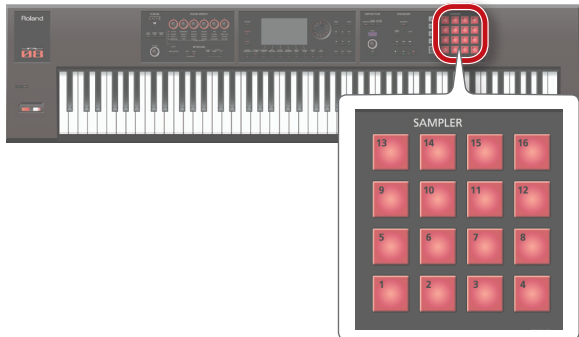

The sample plays.

That pad blinks while the sample plays.

MEMO

- You can press multiple pads simultaneously to make them play.
- You can use the pads to enter numeric values or select parts, or you can assign other functions to the pads (p. 84).

Making samples continue playing (Hold)

1. While pressing a pad, press the [HOLD] button.



The sample continues playing even when you release the pad.

To stop the sample, press the pad again.

If you experience stuck notes!

Press the [HOLD] button four times in rapid succession. This stops all sounds that are being played by the pads.

Switching Banks

A bank is a set of 16 samples assigned to the pads. The FA provides four banks: 1–4.

1. Press the [BANK] button.



The PAD BANK screen appears.



2. Press a pad [1]–[4] to select a bank.

Sampling

The FA can sample the following sounds. Samples that you've recorded can be played back using the pads.

- Keyboard performance
- Input from the AUDIO INPUT jack (audio device, mic, guitar)
- Input from the USB COMPUTER port (USB audio)

MEMO

The sample data is saved on an SD card (within the song data).

Sampling Procedure

Preparing for sampling

1. To the AUDIO INPUT jack, connect the device (audio device, mic, etc.) that you want to sample (p. 8).
2. Press the [SAMPLING] button to make it light.



Pads that don't contain samples are blinking.

NOTE

If you record to a pad that already contains a sample, the existing sample is overwritten.

3. Press the sampling-destination pad to make it light.
The SAMPLING STANDBY screen appears.

MEMO

You can also press the [BANK] button and select a pad in a different bank.

4. Turn the dial to select the desired sampling mode.

Parameter	Sound to be sampled
KBD+INPUT	<ul style="list-style-type: none"> • Keyboard performance • Sound input from the AUDIO INPUT jack • Sound input from the USB COMPUTER port
KBD	Keyboard performance MEMO If USB Audio Input Destination is set to "TFX," the input from the USB COMPUTER port is processed by the TFX and the result is sampled. For details, refer to "Parameter Guide" (PDF).
INPUT	<ul style="list-style-type: none"> • Sound input from the AUDIO INPUT jack • Sound input from the USB COMPUTER port

5. Adjust the sampling volume.

Adjust the volume as high as possible without letting the level meter reach full scale.

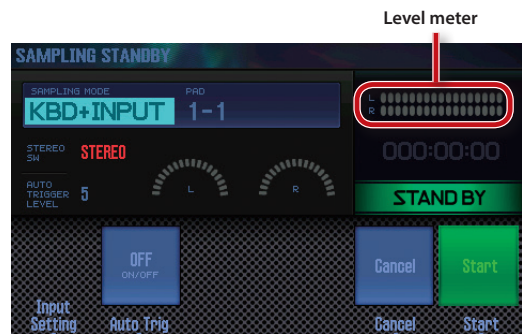

Jack/Port	Explanation
LINE jack	Adjust the level on your audio device.
GUITAR/MIC jack	Adjust the rear panel [LEVEL] knob.
USB COMPUTER port	Adjust the level on your computer.

MEMO

If the volume is insufficient, or if you're unable to adjust the volume successfully, refer to "Setting the Input Volume (Input Setting)" (p.80).

6. Make settings for sampling.

Use the cursor buttons to select a parameter, and use the dial to edit the setting.

Parameter	Value	Explanation
STEREO SW	MONO, STEREO	Choose "MONO" if you're sampling in monaural, such as from a microphone or guitar. Choose "STEREO" if you're sampling in stereo, such as from an audio device.
AUTO TRIGGER LEVEL	0-15	If Auto Trig is "ON," sampling starts when a signal that exceeds this setting is input.
Auto Trig	OFF, ON	If this is "ON," sampling starts when a signal that exceeds the AUTO TRIGGER LEVEL setting is input.

Start sampling

7. Produce sound on the device that's connected to the FA, and press the [7] (Start) button when you want to start sampling.

During sampling, the screen indicates "NOW SAMPLING!"

MEMO

If in step 6 you turned Auto Trig "ON," sampling starts when the input signal exceeds the level specified by AUTO TRIGGER LEVEL.

8. To stop sampling, press the [6] (Stop) button.

Sampling stops, and the sample is saved to the destination pad that you specified.

Setting the Input Volume (Input Setting)

Here's how to set the input volume for the device that's connected to the AUDIO INPUT jack or the USB COMPUTER port.

1. In the SAMPLING STANDBY screen (p. 79), press the [2] (Input Setting) button.

The SYSTEM EFFECTS screen appears.



2. Use the cursor buttons to select a parameter, and use the dial to change the setting.

Tab	Parameter	Value
Audio Input	Audio Input Level	0-127
USB Audio	USB Audio Input Level	0-127

MEMO

You can also access the SYSTEM EFFECTS screen from the EFFECTS EDIT screen (p. 52).

Moving/Copying a Sample (Clip Board)

You can move or copy a sample to another pad.

Moving a Sample

1. While holding down the pad that contains the sample you want to move, press the [CLIP BOARD] button.

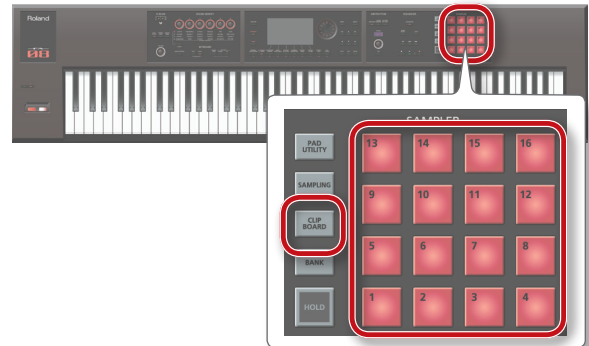

2. While holding down the [CLIP BOARD] button, press the move-destination pad.

The sample is moved.

- * If the move-destination pad contains a sample, the message "Overwrite?" appears. If you want to overwrite, press the [6] (OK) button; if you decide to cancel, press the [7] (Cancel) button.

Copying a Sample

1. While holding down the [SHIFT] button and the pad that contains the sample you want to copy, press the [CLIP BOARD] button.

2. While holding down the [CLIP BOARD] button, press the copy-destination pad.

The sample is copied.

- * If the copy-destination pad contains a sample, the message "Overwrite?" appears. If you want to overwrite, press the [6] (OK) button; if you decide to cancel, press the [7] (Cancel) button.

Editing a Sample

Here's how to edit a sample.

Editing Procedure

1. Press the [PAD UTILITY] button.

The SAMPLE PAD screen appears.



2. Press a pad to select the sample that you want to edit.

3. Press the [2] (Sample Edit) button.

The SAMPLE EDIT screen appears.



4. Use the cursor buttons to select a parameter, and use the dial to change the setting.

Parameter	Value	Explanation
START POINT ([1] knob)	000000000-	This is the playback start point. Adjust this to skip any unwanted portion of the waveform at the beginning of the sample, so that the desired sound plays immediately.
END POINT ([2] knob)	000001000-	This is the playback end point. Adjust this to omit any unwanted portion of the waveform at the end of the sample, so that it does not play. * The distance between the start point and the end point cannot be 999 or less.
ZOOM HORZ ([3] knob)	1/1-1/65536	Changes the horizontal zoom (the time axis of the waveform).
ZOOM VERT ([4] knob)	x1-x128	Changes the vertical zoom (the amplitude axis of the waveform).
GATE	OFF, ON	Specifies whether the sample will stop playing when you release the pad (ON) or will continue playing even after you release the pad (OFF).
LOOP	OFF, ON	Specifies whether the sample will (ON) or will not (OFF) play as a loop.
LEVEL ([6] knob)	0-127	Adjusts the volume of the sample.
EFFECT SW	OFF, ON	Specifies whether the effect will (ON) or will not (OFF) be applied to the sample. MEMO You can apply Master Comp, Master EQ, and TFX to the sample.

5. Press the [7] (EXIT) button.

The sample is saved.

MEMO

The sample is saved when you exit the SAMPLE EDIT screen.

Renaming the Sample (Rename)

Here's how to change the name of the sample.

1. In the SAMPLE EDIT screen, press the [2] (Rename) button.

2. Assign a name to the sample (p. 45).

Cutting Unwanted Regions from the Sample (Truncate)

Here's how you can cut unwanted regions from the beginning and end of the sample by specifying the desired portion (start point and end point).

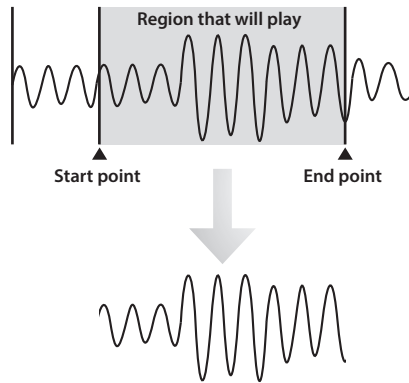

1. In the SAMPLE EDIT screen, press the [3] (Truncate) button.

A confirmation message appears.

If you decide to cancel, press the [7] (Cancel) button.

2. Press the [6] (OK) button.

The Truncate operation is executed.

Deleting a Sample (Delete)

Here's how to delete a sample.

1. Press the [PAD UTILITY] button.

2. Press a pad to select the sample that you want to delete.

3. Press the [4] (Sample Delete) button.

A confirmation message appears.

If you decide to cancel, press the [7] (Cancel) button.

4. Press the [6] (OK) button.

The sample is deleted.

MEMO

You can also delete a sample from the SAMPLE EDIT screen (p. 81) by using the [4] (Sample Utility) button.

Zooming the Sample Display (Zoom)

You can change the magnification at which the sample is displayed.

1. In the SAMPLE EDIT screen (p. 81), press the [5] (Zoom) button.
2. Use the cursor buttons to change the display zoom.

Auditioning the Edited Result (Preview)

Here's how to audition the result of your sample editing.

1. In the SAMPLE EDIT screen (p. 81), press the [6] (Preview) button.
The sample plays.

Exporting the Sample in WAV Format (Export Sample)

Here's how to export the sample in WAV format.

1. In the SAMPLE EDIT screen (p. 81), press the [4] (Sample Utility) button.
2. Move the cursor to "Export Sample (WAV)," and press the [7] (Select) button.
A confirmation message appears.
If you decide to cancel, press the [7] (Cancel) button.
3. Press the [6] (OK) button.

The exported WAV file is saved in the SD card's "EXPORT SAMPLE" folder.

- * If there is an identically-named file in the export-destination, a message asks "Overwrite?" Press the [6] (OK) button if you want to overwrite, or press the [7] (Cancel) button if you decide to cancel.

NOTE

Never turn off the power while data is being exported.

MEMO

- You can export all samples of the song in a single operation (p. 76).
- If you execute Truncate before you export, the WAV between the start point and end point is exported.

Importing an Audio File (Sample Import)

You can import an audio file and play it as one of the FA's samples.

1. Before you continue, place the audio file to be imported in the "IMPORT" folder of the SD card.
2. Press the [PAD UTILITY] button.
3. Press the [5] (Sample Import) button.
4. Use the dial or the [DEC] [INC] buttons to select the audio file that you want to import, and press the [7] (Select) button.

MEMO

- By pressing the [4] (Auto Import) button you can import samples to multiple vacant pads in a single operation. Proceed to step 6. If there are no vacant pads, importing is not possible.
- You can change the import-source folder.
Press the [2] (Folder) button to access the Change Folder window. When you select the import-source folder, the files in the selected folder are shown in the SAMPLE IMPORT screen.

5. Press a pad to select the import-destination pad.
6. Press the [7] (Execute) button.
A confirmation message appears.
If you decide to cancel, press the [7] (Cancel) button.
7. Press the [6] (OK) button.
The WAV file is imported.

Audio files that can be imported

WAV/AIFF	Sampling frequency	44.1/48/96 kHz
	Bit rate	8/16/24 bit
MP3	Format	MPEG-1 audio layer 3
	Sampling frequency	44.1 kHz
	Bit rate	64/80/96/112/128/160/192/ 224/256/320 kbps, VBR (Variable Bit Rate)

Switching the Sample Information Display (Change Information)

You can switch the sample information that is shown in the SAMPLE PAD screen.

1. In the SAMPLE PAD screen (p. 81), press the [3] (Change Information) button.

The displayed information changes each time you press the button.



- Sample name
- GATE and LOOP on/off status
- EFFECT SW on/off status



- Sample name
- Stereo/mono
- Sample size

07: Pads

Explains how to use the pads.

Using the Pads..... 84

Using the Pads

In addition to using the FA's pads to play samples, you can assign the pads to perform a variety of other functions.

Specifying the Function of the Pads (PAD UTILITY)

Here's how to specify the function of the pads.

1. Press the **[PAD UTILITY]** button.



2. Press the **[6] (Pad Mode)** button.
3. Press a pad **[1]–[7]** to select the desired function.
A setting screen appears according to the function that you select.

Pad	Function	Explanation
[1]	SAMPLE PAD	The pads play samples.
[2]	PART SELECT	The pads select parts.
[3]	PART MUTE	The pads turn part mute on/off.
[4]	PART SOLO	The pads turn part solo on/off.
[5]	NUMERIC	The pads function as numeric keys.
[6]	PARTIAL SW/SEL	The pads select partials and turn them on/off.
[7]	KBD SW	The pads turn the keyboard switch on/off.

MEMO

You can also select the pad function by holding down the **[PAD UTILITY]** button and pressing a pad **[1]–[7]**.

Playing Samples (SAMPLE PAD)

The pads play samples.

MEMO

For details, refer to “**Selecting/Playing Samples**” (p.78).

Selecting Parts (PART SELECT)

You can use the pads to select parts (1–16).

- * When you're performing in the STUDIO SET PLAY screen, the parts that you can select are limited by the performance mode. If you're using single play mode, only part 1 can be selected. If you're using Dual or Split performance mode, only parts 1 and 2 can be selected.

MEMO

- The pad of the selected part blinks.
- The pad number corresponds to the part number.
- When you're using Split performance, pad **[1]** selects the lower part (part 2), and pad **[2]** selects the upper part (part 1).

Switching Part Mute (PART MUTE)

You can use the pads to mute (silence) the parts (1–16).

When you press a pad, the corresponding part switches between mute (blinking) and play (lit).

MEMO

The pad number corresponds to the part number.

Switching the Soloed Part (PART SOLO)

You can use the pads to switch the part that's being soloed (p.44, p.63).

When you press the blinking pad once again, solo turns off.

MEMO

The pad number corresponds to the part number.

Using the Pads as Numeric Keys (NUMERIC)

You can use the pads as numeric keys.

This is convenient when entering numeric parameter values.

Pad	Explanation
[1]–[9]	1–9
[10]	0
[11]	–
[12]	+
[HOLD]	Confirm (same operation as the [ENTER] button)
[BANK]	Cancel (same operation as the [EXIT] button)

Selecting Partials and Turning Them On/Off (PARTIAL SW/SEL)

You can use the pads to select a partial to edit, and to turn it on/off.

Pad	Explanation
[1]	Select partial 1
[2]	Select partial 2
[3]	Select partial 3
[4]	Select partial 4
[5]	Turn partial 1 on/off
[6]	Turn partial 2 on/off
[7]	Turn partial 3 on/off
[8]	Turn partial 4 on/off

- * This is available only if you've selected a tone in which that partial exists. If the tone's type is SuperNATURAL synth tone, partial 4 does not exist, so pads **[4]** and **[8]** cannot be used.

Turning the Keyboard Switch On/Off (KBD SW)

You can use the pads to turn the keyboard switch (p. 27) on/off.

When you press a pad, the keyboard switch of the corresponding parts turns on (blinking) or off (lit).

* The keyboard switch is available only in multi part play mode.

MEMO

- The pad number corresponds to the part number.
- The keyboard switch settings are saved in the studio set.

Overview

Performing

Performance
Functions

Editing

Sequencer
(Creating Songs)

Sampler

Pads

DAW

Settings

Appendix

08: DAW

Explains how to use the FA in conjunction with a computer or DAW controller.

Connecting to a Computer via USB 88

Using the FA with DAW Software 89

Connecting to a Computer via USB

If you use a commercially available USB cable to connect a USB port of your computer to the USB COMPUTER port located on the rear panel of the FA, you can use MIDI-compatible software (DAW software) to play back audio and MIDI data on the FA.

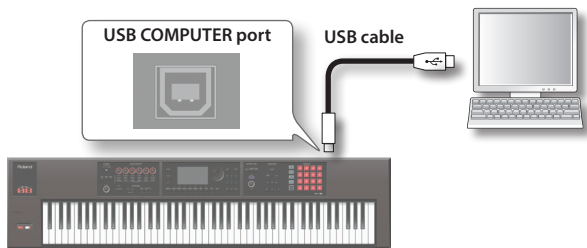

For details on operating requirements, refer to the Roland website.
Roland website
<http://www.roland.com/support/>

NOTE

- For some types of computer, this might not work correctly. Refer to the Roland website for details on the operating systems that are supported.
- A USB cable is not included. You can purchase one from the dealer where you purchased the FA.
- Use a USB 2.0 cable.
- Your computer's USB port must support USB 2.0 Hi-Speed.
- Turn on the power of the FA before you start the DAW software on your computer. Don't turn the FA's power on/off while your DAW software is running.

USB audio

FA → computer

If the FA is connected to your computer via a USB cable, the audio output you've chosen in the FA can be recorded into your computer's DAW software.

Computer → FA

If the FA is connected to your computer via a USB cable, the sound of your computer can be reproduced from an audio system connected to the FA's MAIN OUTPUT jacks.

USB MIDI

If the FA is connected to your computer via a USB cable, the FA's performance data (MIDI data) can be recorded into your DAW software, and performance data (MIDI data) played back by your DAW software can be sounded by the FA's sound engine.

Installing the USB Driver

The USB driver is software that exchanges data between the FA and your computer software.

In order to use the FA's dedicated USB driver, you must install the USB driver.

MEMO

For details on downloading and installing the USB driver, refer to the Roland website.

<http://www.roland.com/support/>

Making USB Driver Settings

Here's how to switch between the FA's dedicated USB driver and the generic driver provided by your operating system.

1. Press the **[MENU]** button.
The MENU screen appears.
2. Move the cursor to **"System"** and press the **[ENTER]** button.
The SYSTEM SETUP screen appears.
3. Use the cursor **[◀] [▶]** buttons to select the **"General"** tab.
4. Specify the USB Driver.

Driver	Explanation
VENDOR (MIDI+AUDIO)	The dedicated driver provided by Roland specifically for the FA is used. Both MIDI and audio are available.
GENERIC (MIDI only)	The generic driver of the operating system is used. Only MIDI is available.

MEMO

This system takes effect when the FA is powered-on following System Write.

5. Press the **[6] (Write)** button to save the setting.
6. Turn the power off, and then on again.

Using the FA with DAW Software

Using the FA as a DAW Controller

You can use the FA as a controller for your DAW software. The FA provides various DAW control maps. Simply select the appropriate control map to apply the appropriate settings for the DAW software that you're using.

MEMO

If you want to use the FA as a controller for your DAW software, set the USB Driver setting to **"VENDOR (MIDI+AUDIO)."**

Using the FA to Control DAW Software

1. Use a USB cable to connect the FA to your computer.

A confirmation message appears.

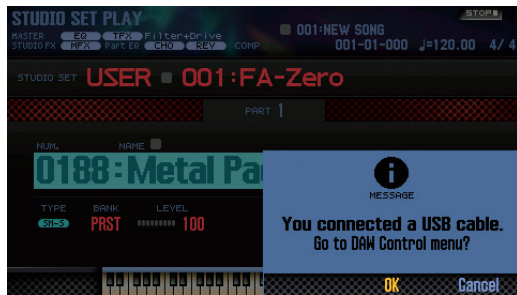

MEMO

This message is not shown if you power-on the FA with it already connected to the computer.

2. Press the [6] (OK) button.

DAW Control mode is on, and the DAW CONTROL screen appears.

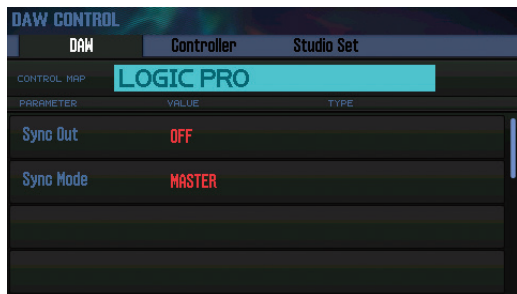

MEMO

- You can also turn DAW Control mode on/off by pressing the **[DAW CONTROL]** button.
- As necessary, make the synchronization settings **"Sync Out"** and **"Sync Mode"** (p. 101).

3. Move the cursor to "CONTROL MAP" and use the dial to select the DAW software that you're using.

Value	Explanation
LOGIC PRO	When controlling Logic Pro.
SONAR	When controlling SONAR.
CUBASE	When controlling Cubase.
USER	Choose "USER" if your system cannot use the Mackie Control control surface. You'll be able to choose the MIDI messages that are transmitted when you press pads [1]–[8].

4. Use the cursor [◀] [▶] buttons to select the "Controller" tab.

5. Turn the Local Switch "OFF" (p. 90).

6. In your DAW software, open the project file that you want to control.

MEMO

Before you continue, select **"FA-06 08"** as the MIDI input device and output device. For details on how to do this, refer to the owner's manual of your DAW software.

7. Make the appropriate control surface settings for the DAW software you selected (p. 90).

8. Operate the FA to control your DAW software.

Available controllers	Explanation
[▶] button	Start playback.
[●] button	Start recording on record-standby tracks.
[◀] button	Return the current position to the beginning.
[◀◀] button	Rewind.
[▶▶] button	Fast-forward.
[■] button	Stop recording or playback.
The [▶] through [■] buttons emulate the Mackie Control control surface.	
Pad [1]–[8]	Emulate the Mackie Control control surface Function buttons (F1–F8).
[1]–[6] knob	Control the function that's assigned. (p. 90)
[S1] [S2] button	

Settings in LOGIC PRO

This explanation describes the procedure when using Logic Pro X. The procedure may differ for other versions.

1. From the Logic Pro X menu, choose **[Logic Pro X]** → **[Control Surfaces]** → **[Setup]** to open the setting screen.
2. From the menu, choose **[New]** → **[Install]**.
3. From the list of Model, choose **“Mackie Control”** and press **“Add.”**
4. As the input port and the output port, specify **“FA-06 08 DAW CTRL.”**

Settings in SONAR

This explanation describes the procedure when using SONAR X2 Producer. The procedure may differ for other versions.

1. From the SONAR menu, choose **[Edit]** → **[Preferences]** → **[MIDI Devices]** to open the input/output device selection.
2. To the input devices and output devices, add **“FA-06 08 DAW CTRL.”**
3. In **[Preferences]**, choose **[MIDI Control Surfaces]**.
4. Press **“Add new Controller/Surface”** to access the control surface settings dialog box.
5. Choose **“Mackie Control”** as the control surface, choose **“FA-06 08 DAW CTRL.”** as the input port and output port, and then press **“OK.”**

Settings in CUBASE

This explanation describes the procedure when using the Mac OS X version of Cubase 7. The procedure may differ for other versions.

1. From the Cubase **[Devices]** menu, choose **[Device Setup]**.
2. Press the **[+]** button located in the upper left of the dialog box, and choose **“Mackie Control”** from the pulldown menu.
3. As the MIDI input and MIDI output for Mackie Control, specify **“FA-06 08 DAW CTRL.”**
4. In the left side of the dialog box, choose **“MIDI Port Setup”** to access the setting screen.
5. In **“FA-06 08 DAW CTRL,”** clear the check box from **“In ‘ALL MIDI Inputs’”**

Assigning Functions to Knobs and Buttons

You can assign functions to the **[1]–[6]** knobs and the **[S1] [S2]** buttons.

You can store sixteen sets of these assignments, with each set containing the assignments of the **[1]–[6]** knobs and the **[S1] [S2]** buttons.

1. In the DAW CONTROL screen, select the **“Controller”** tab.



2. Select the set of assignments that you want to edit.

MEMO

You can press the **[ENTER]** button and rename the set.

3. Use the cursor buttons to select a parameter, and use the dial to edit the setting.

Parameter	Explanation
Local Switch	Turns the Local switch (p. 100) on/off when in DAW Control mode.
Tx Channel	Specifies the MIDI transmit channel used when in DAW Control mode. Set this as desired.
S1, S2	Select the MIDI messages that are transmitted when you press the [S1] [S2] buttons.
Knob 1–6	Select the MIDI messages that are transmitted when you turn the [1]–[6] knobs.

MEMO

If you want your settings to be remembered, save the DAW CONTROL settings (p. 92).

Using the FA as a MIDI Keyboard

Your playing on the FA's keyboard (MIDI data) can be recorded into your DAW software, or used to play software instruments.

1. Connect the FA to your computer and turn on DAW Control mode.
2. In the DAW CONTROL screen, select the **“Controller”** tab.
3. Turn the Local Switch **“OFF.”**

MEMO

Set the MIDI transmit channel as necessary (Tx Channel: p. 90).

Playing the FA's Sound Engine from DAW Software

Performance data (MIDI data) played back by your DAW software can make the FA's sound engine produce sound.

1. Connect the FA to your computer, and turn DAW Control mode on.
2. Start your DAW software, and open the project file that you want to play.

MEMO

Before you continue, select "FA-06 08" as the MIDI input device and output device.

For details on how to make this setting, refer to the owner's manual of your DAW software.

3. In the DAW CONTROL screen, select the "Studio Set" tab.



* Depending on the channel settings of your DAW, messages that switch studio sets may be transmitted on the channel of a part, causing the tone to switch. If this occurs, check the channel settings of your DAW.

4. Move the cursor to "RxCH" of the tone that you want to play, and use the dial to specify the receive channel.

MEMO

If you turn RxSw off, MIDI messages are not received.

It is convenient to turn RxSw on/off if you temporarily want to stop receiving MIDI messages.

5. In your DAW software, set the transmit channels of the tracks that you're playing back to match the receive channel settings of the FA.

For details on how to make this setting, refer to the owner's manual of your DAW software.

6. Play back your DAW software.

You hear the playback sounded by the FA's tones.

Using the FA as an Audio Interface

The FA's audio output you've specified can be recorded into DAW software on your computer.

Sound from your computer can also be reproduced from a device that's connected to the FA's MAIN OUTPUT jacks.

1. Connect the FA to your computer.
2. Start up your DAW software, and choose "FA-06 08" as the audio input device and output device.

For details on how to make this setting, refer to the owner's manual of your DAW software.

Specifying the USB Audio Output

Here's how to specify the USB audio that is output from the USB COMPUTER port.

1. In the SYSTEM SETUP screen (p. 97), press the [3] (System Effects) button.

The SYSTEM EFFECTS screen appears.

2. Use the cursor [◀][▶] buttons to select the "USB Audio" tab.



3. Move the cursor to "USB Audio Output Select" and use the dial to change the setting.

Value	Explanation
MAIN	The same sound as the output of the MAIN OUTPUT jacks is output to the USB COMPUTER port.
INPUT	The sound being input from the AUDIO INPUT jack is output without change to the USB COMPUTER port.
INPUT-EFX	The sound being input from the AUDIO INPUT jack is processed by the noise suppressor (NS) and microphone reverb (MIC Reverb) before being output to the USB COMPUTER jack.

The USB audio signal flow can be viewed in the EFFECTS EDIT screen (p. 52).

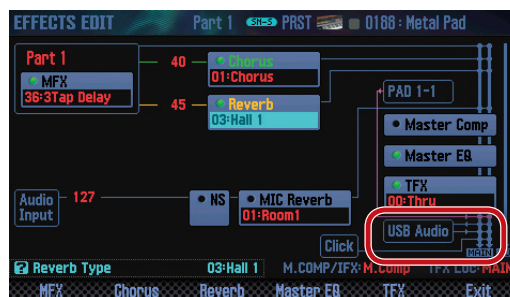

Saving the DAW CONTROL Settings

The DAW CONTROL settings revert to their previous state when you turn off the power. If you want the DAW CONTROL settings to be remembered even after power-off, save them.

1. In the DAW CONTROL screen, press the [Write] button.

A confirmation message appears.

If you decide to cancel, press the [7] (**Cancel**) button.

2. Press the [6] (OK) button.

The DAW CONTROL settings are saved.

MEMO

When you save the DAW CONTROL settings, the system settings are also saved.

NOTE

Never turn off the power while settings are being saved.

09: Settings

Explains convenient functions, and settings that apply to the entire FA.

Useful Functions.....	94
Settings for the Entire FA.....	97
About the Wireless LAN Function.....	104

Useful Functions

Basic Procedure for Utility Operations

1. Press the **[MENU]** button.
The MENU screen appears.
2. Move the cursor to **“Utility”** and press the **[ENTER]** button.
The UTILITY screen appears.

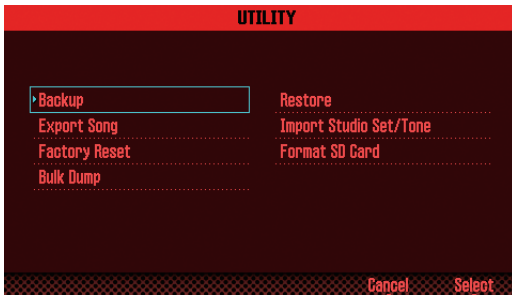

3. Select the function that you want to execute, and press the **[ENTER]** button.

Function	Explanation	Page
Backup	Writes the user memory and system memory data to an SD card.	p. 94
Restore	Loads backed-up data from an SD card into the FA.	
Export Song	Exports a song in WAV/SMF format. Also, exports samples in WAV format.	p. 74
Import Studio Set/Tone	Imports a studio set or a tone from data backed-up to an SD card. You can also import INTEGRA-7 tones that you download from the Axial site.	p. 95
Factory Reset	Returns the FA to the factory-set condition.	p. 95
Format SD Card	Initializes an SD card.	p. 96
Bulk Dump	Sends the studio set and tone settings of the temporary area to an external MIDI device.	p. 96

Backing Up User Data (Backup/Restore)

The contents of the FA's user memory and system memory (p. 14) can be saved to an SD card (Backup) or returned to the FA (Restore).

Backing Up to an SD Card (Backup)

NOTE

If you back up with a file name that is identical to existing backup data on the SD card, the existing data is overwritten. If you want to save a new backup, assign it a different name.

1. In the UTILITY screen, select **“Backup”** and press the **[ENTER]** button.
2. Press the **[2]** (**Rename**) button and assign a name to the file that you want to back up (p. 45).
3. Press the **[7]** (**Backup**) button.
A confirmation message appears.
If you decide to cancel, press the **[7]** (**Cancel**) button.
4. Press the **[6]** (**OK**) button.
The data is backed up to the SD card.

NOTE

Never turn off the power while a backup is in progress.

Returning Backup Data to the FA (Restore)

1. In the UTILITY screen, select **“Restore”** and press the **[ENTER]** button.
2. Use the cursor buttons to select the file that you want to restore, and press the **[7]** (**Restore**) button.
A confirmation message appears.
If you decide to cancel, press the **[7]** (**Cancel**) button.

NOTE

When you execute the Restore operation, all settings currently saved in the FA are lost. If you want to keep the current settings, back them up with a different name.

3. Press the **[6]** (**OK**) button.
When the restore is complete, the message **“Completed. Please Power Off!”** appears.

NOTE

Never turn off the power during the Restore operation.

4. Turn the power off, and then on again.

Importing a Studio Set or Tone (Import Studio Set/Tone)

You can import a studio set or tone from data that you backed-up on an SD card.

You can also import INTEGRA-7 tones that you download from the Axial site.

Importing from Backup Data

1. In the UTILITY screen, select “Import Studio Set/Tone” and press the [ENTER] button.

2. Use the cursor buttons to select the backup data, and press the [7] (Select) button.

MEMO

You can change the import-source folder.

Press the [2] (Folder) button to access the CHANGE FOLDER window. When you select the import-source folder, the files within the selected folder appear in the IMPORT (SELECT FILE) window. If you're importing tones that you downloaded from the Axial site, select the “IMPORT” folder.

3. Use the cursor buttons to select the studio sets or tones that you want to import, and assign a check mark to them.

Button	Explanation
[2] (Mark)	Applies a check mark.
[3] (Mark All)	Applies check marks to all studio sets or tones in the list.
[4] (Search ▲)	In the list, jumps to the studio set or tone to which you applied a check mark.
[4] (Search ▼)	

4. Press the [7] (Import) button.
5. Select the save-destination of the data that you want to import, and press the [7] (Execute) button.
A confirmation message appears.
If you decide to cancel, press the [7] (Cancel) button.
6. Press the [6] (OK) button.
The selected file is imported.

Importing Tones Downloaded from the Axial Site

You can import INTEGRA-7 tones that you download from the Axial site.

1. Download INTEGRA-7 tones from Axial.

MEMO

For details on how to download tones, refer to the Axial site.

<http://axial.roland.com/>

2. Using your computer, copy the tone data to the “IMPORT” folder of the SD card.

3. Import the tones as described in “Importing from Backup Data” (p.95).

Axial is a sound library site from which you can download additional sounds for Roland synthesizers.



Restoring the Factory Settings (Factory Reset)

Here's how the settings stored in the FA can be restored to their factory-set state (Factory Reset).

NOTE

When you execute the Factory Reset operation, all data saved in the FA is lost. If you want to keep the data, back it up to an SD card.

1. In the UTILITY screen, select “Factory Reset” and press the [ENTER] button.

A confirmation message appears.

If you decide to cancel, press the [7] (Cancel) button.

2. Press the [6] (OK) button.

The factory reset is executed.

NOTE

- Never turn off the power while the Factory Reset operation is in progress.
- The data on the SD card will not return to the factory-set state.

Initializing an SD Card (Format SD Card)

Here's how to initialize (format) an SD card.

NOTE

- **Do not format the SD card that is included with this product.**
If you format the SD card that is included with this product, all of the demo song data on the card is erased.
- **Back up the data to your computer before formatting the card.**
When you format a card, all its data is lost. If the SD card contains important data, back it up first as described in **"Backing-Up SD Card Data to a Computer"** (p.96).

1. In the **UTILITY** screen, select **"Format SD Card"** and press the **[ENTER]** button.

A confirmation message appears.

If you decide to cancel, press the **[7] (Cancel)** button.

2. Press the **[6] (OK)** button.

The SD card is formatted.

Backing-Up SD Card Data to a Computer

1. Remove the SD card from the FA.

2. Insert the SD card into your computer.

If your computer does not have an SD card slot, use a commercially-available SD card reader.

3. Copy (drag and drop) all folders of the SD card into a folder on your computer.

NOTE

You must copy all folders. The system will not work correctly if you copy only some of the folders.

4. Stop the SD card connection, and remove the SD card from your computer.

5. Insert the SD card into the FA.

Restoring Backed-Up Data to a SD Card

1. Remove the SD card from the FA.

2. Insert the SD card into your computer.

If your computer does not have an SD card slot, use a commercially-available SD card reader.

3. Copy (drag and drop) all of the backed-up folders from your computer to the SD card.

NOTE

- When you copy the backed-up data to an SD card, the data previously stored on that SD card is lost.
- You must copy all folders. The system will not work correctly if you copy only some of the folders.

4. Stop the SD card connection, and remove the SD card from your computer.

5. Insert the SD card into the FA.

Transmitting the Temporary Area's Data to an External MIDI Device (Bulk Dump)

Here's how to transmit the studio set and tone settings to an external MIDI device. This operation is called **"bulk dump."** You can use this operation when you want to connect another FA unit and play it using identical settings, or when you want to save your studio set and tone settings on an external MIDI device as a precaution against data loss.

Connect the FA to your external MIDI device as shown in the illustration before you proceed.

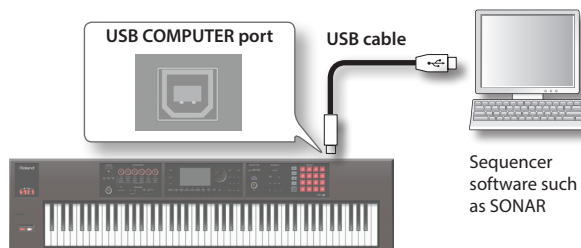

1. In the **UTILITY** screen, choose **"Bulk Dump"** and press the **[ENTER]** button.

A confirmation message appears.

If you decide to cancel, press the **[7] (Cancel)** button.

2. Press the **[6] (OK)** button.

The bulk dump is executed.

Settings for the Entire FA

These settings apply to the FA as a whole

Basic Procedure for System Settings

1. Press the [MENU] button.
The MENU screen appears.
2. Move the cursor to “System” and press the [ENTER] button.
The SYSTEM SETUP screen appears.

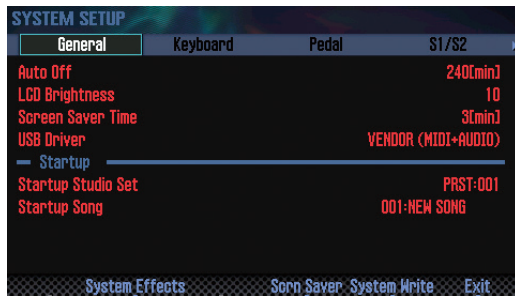

3. Use the cursor buttons to select a parameter, and use the dial to change the value.

MEMO

You can make system effect settings by pressing the [3] (System Effects) button.
For details on the system effect parameters, refer to “Parameter Guide” (PDF).

Saving the System Settings

System settings will return to their previous state when you turn off the unit. If you want these settings to be retained even after the unit is turned off, you must save the system settings.

1. In the SYSTEM SETUP screen, press the [6] (System Write) button.

The settings will be saved.

NOTE

Never turn off the unit while data is being saved.

System Parameter

The operations of the system parameters are explained below, organized according to the structure of the parameters.

General settings (General)

Parameter	Value	Explanation
Auto Off	OFF, 30 [min], 240 [min]	Specifies whether the unit will turn off automatically after a certain time has elapsed. If you don't want the unit to turn off automatically, choose “OFF” setting.
LCD Brightness	1–20	Adjusts the brightness of the display. The brightness will increase as the value is raised.

Parameter	Value	Explanation
Screen Saver Time	OFF, 30 [sec], 1–60 [min]	The screen saver starts after a certain time has elapsed. If you don't want the screen saver to start, turn this “OFF.” MEMO You can view the displayed screen by pressing the [5] (Scr'n Saver) button.
USB Driver	VENDOR (MIDI+AUDIO)	The dedicated driver provided by Roland specifically for the FA is used. MIDI and audio are both available.
	GENERIC (MIDI only)	The generic driver provided by the operating system is used. Only MIDI is available.
Startup		
Startup Studio Set	SONG, (Studio set number)	Specifies the studio set that will be loaded when the unit is turned on. Choose “SONG” if you want to use the studio set that is selected by the song.
Startup Song	LAST-saved, (Song name)	Specifies the song that will be loaded when the unit is turned on. If you want the most recently saved song to be loaded, choose “LAST-SAVED.”

Keyboard settings (Keyboard)

Parameter	Value	Explanation
Keyboard Velocity	REAL	Specifies the velocity transmitted when a key is played. The transmitted velocity value will correspond to the force with which you strike the key.
	1–127	The transmitted velocity value will be fixed, regardless of the force with which you strike the key.
Keyboard Velocity Curve	LIGHT	The keyboard will have a lighter-feeling touch. Since you'll be able to reach fortissimo (ff) without having to play as strongly as with the “MEDIUM” setting, the keyboard will feel lighter. This setting makes it easier for people with reduced finger strength to play the keyboard.
	MEDIUM	This is the standard keyboard touch setting.
	HEAVY	The key will have a heavier-feeling touch. Since you'll need to play more strongly than with the “MEDIUM” setting in order to reach fortissimo (ff), the keyboard will feel heavier. This setting allows you to use your playing dynamics to add more expression to your performances.
Keyboard Velocity Curve Offset	-10–+9	Adjusts the keyboard velocity curve. Lower values make the keyboard feel lighter. Higher values make the keyboard feel heavier.
Arpeggio		
Arpeggio Trigger Quantize		Specifies how arpeggios will be triggered.
	OFF	The arpeggio starts the moment you play the keyboard.
	BEAT	If you play the keyboard while the sequencer or a rhythm pattern is playing, the arpeggio automatically starts at the beginning of the beat.
	MEASURE	If you play the keyboard while the sequencer or a rhythm pattern is playing, the arpeggio automatically starts at the beginning of the measure.

Overview

Performing

Performance Functions

Editing

Sequencer (Creating Songs)

Sampler

Pads

DAW

Settings

Appendix



Pedal settings (Pedal)

Parameter	Value	Explanation	
Control Pedal			
Pedal Assign Source	SYSTEM, STUDIO	Specifies whether the functions controlled by the pedals connected to the FOOT PEDAL CTRL 1 and 2 jacks will be determined by the system settings (SYSTEM) or by the studio set settings (STUDIO).	
Control Pedal 1 Assign	Specify the functions that are controlled by pedals connected to the FOOT PEDAL CTRL 1 and 2 jacks.		
	OFF	No function is assigned.	
	CC01–31, 32 (OFF), 33–95	Controller number 1–31, 33–95	
	BEND DOWN	The same effect as moving the pitch bend lever to the right.	
	BEND UP	The same effect as moving the pitch bend lever to the left.	
	AFTERTOUCH	Aftertouch	
	START/STOP	Start/stop the song.	
	Control Pedal 2 Assign	TAP TEMPO	The same effect as pressing the panel [TAP] button.
		STUDIO SET DOWN	Switch the studio set to the previous number.
		STUDIO SET UP	Switch the studio set to the next number.
	FAVORITE DOWN	Switch the favorite to the previous number.	
	FAVORITE UP	Switch the favorite to the next number.	
	PANEL-DEC	The same effect as pressing the panel [DEC] button.	
	PANEL-INC	The same effect as pressing the panel [INC] button.	
Control Pedal 1 Polarity	STANDARD, REVERSE	Selects the polarity of the pedals connected to the FOOT PEDAL CTRL 1 and 2 jacks.	
Control Pedal 2 Polarity		Depending on the model of pedal, the result of depressing or releasing the pedal might be the opposite of what you expect. If so, choose the "REVERSE" setting. If you're using a Roland pedal (that has no polarity switch), choose the "STANDARD" setting.	
Hold Pedal			
Hold Pedal Polarity	STANDARD, REVERSE	Selects the polarity of the pedal connected to the FOOT PEDAL HOLD jack. Depending on the model of pedal, the result of depressing or releasing the pedal might be the opposite of what you expect. If so, choose the "REVERSE" setting. If you're using a Roland pedal (that has no polarity switch), choose the "STANDARD" setting.	
Continuous Hold Pedal	OFF, ON	If this is ON, the FOOT PEDAL HOLD jack will support half-pedaling. If half-pedaling is enabled, you can connect a damper pedal (such as the DP-10; available separately) and use the pedal to control subtle nuances of the piano sounds you play.	

[S1] [S2] button settings (S1/S2)

Parameter	Value	Explanation	
S1/S2 Assign Source	SYSTEM, STUDIO	Specifies whether the functions controlled by the [S1] [S2] buttons will be determined by the system settings (SYSTEM) or by the studio set settings (STUDIO).	
Assignable			
Switch S1 Assign	Specify the functions that are controlled by the [S1] [S2] buttons.		
	OFF	No function is assigned.	
	CC01–31, 32 (OFF), 33–95	Controller number 1–31, 33–95	
	AFTERTOUCH	Aftertouch	
	MONO/POLY	Switch between mono/poly.	
	CHORUS SWITCH	Turn the chorus on/off.	
	Switch S2 Assign	REVERB SWITCH	Turn the reverb on/off.
		MASTER EQ SWITCH	Turn the master EQ on/off.
		TFX SWITCH	Turn the total effect on/off.
		MASTER KEY DOWN	Lower the keyboard range by a semitone.
	MASTER KEY UP	Raise the keyboard range by a semitone.	
Switch S1 Assign Mode	MOMENTARY, LATCH	Specify the operation of the [S1] [S2] buttons.	
Switch S2 Assign Mode			



For the basic procedure for system settings, refer to p. 97.

SOUND MODIFY knob settings (Knob)

Parameter	Value	Explanation
Knob Assign Source	SYSTEM, STUDIO	Specifies whether the functions controlled by the SOUND MODIFY knobs will be determined by the system settings (SYSTEM) or by the studio set settings (STUDIO).
Knob Mode	DIRECT, CATCH	When you operate a knob, this setting specifies whether control data corresponding to the knob's position is always transmitted (DIRECT) or whether control data is transmitted only after the knob passes through the current value of the parameter (CATCH).
Auto Knob Reset (for Single)	OFF, ON	When you switch tones in Single play mode, this setting specifies whether the SOUND MODIFY knob settings are reset (ON) or not reset (OFF). If this is "ON," the following parameters are reset when you switch tones. <ul style="list-style-type: none"> CUTOFF RESONANCE ATTACK RELEASE PAN LEVEL EQ LOW EQ MID1 EQ MID2 EQ MID3 EQ HIGH COMPRESSOR TONE TFX SELECT ASSIGN 1, ASSIGN 2, ASSIGN 3, ASSIGN 4, ASSIGN 5 (with the KNOB ASSIGN settings in their factory-set state)
Assignable		
Sound Modify Knob 1–6 Assign	Specify the functions that are controlled by the SOUND MODIFY knobs.	
	OFF	No function is assigned.
	CC01–31, 32 (OFF), 33–95	Controller number 1–31, 33–95
	PITCH BEND	Applies the same effect as when the pitch bend lever is moved.
	AFTERTOUCH	Aftertouch
	TFX PARAM 1–3	Controls parameters 1–3 of the Total Effect.

D-BEAM controller settings (D-Beam)

Parameter	Value	Explanation
D-Beam Sens	0–127	The higher the value you set for this parameter, the more sensitive the D-BEAM controller becomes.
D-Beam Assign Source	SYSTEM, STUDIO	Specifies whether the functions controlled by the D-BEAM controller will be determined by the system settings (SYSTEM) or by the studio set settings (STUDIO).

Parameter	Value	Explanation
D-Beam Switch	Specify the functions that are controlled by the D-BEAM controller.	
	OFF	No function is assigned.
	SOLO SYNTH	The D-BEAM controller operates as a monophonic synthesizer.
	EXPRESSION	The D-BEAM controller controls the volume.
	ASSIGNABLE	The D-BEAM controller controls the function that you assign.
Solo Synth		
Level	0–127	Adjusts the volume of the solo synth.
Chorus Send Level	0–127	Adjusts the chorus send level.
Reverb Send Level	0–127	Adjusts the reverb send level.
Range	2–8OCT	Adjusts the range in which the pitch of the solo synth will vary.
Osc 1 Waveform	SAW, SQR	Selects the waveform. SAW (sawtooth wave), SQR (square wave)
Osc 1 Pulse Width	0–127	Specifies the pulse width of the waveform. By cyclically modifying the pulse width you can create subtle changes in the tone.
Osc 1 Coarse Tune	-48–+48	Adjusts the pitch of the tone's sound (in semitones, +/-4 octaves).
Osc 1 Fine Tune	-50–+50	Adjusts the pitch of the tone's sound (in 1-cent steps).
Osc 2 Waveform	(same as Osc 1)	
Osc 2 Pulse Width		
Osc 2 Coarse Tune		
Osc 2 Fine Tune		
Osc 2 Level	0–127	Adjusts the level of the Osc 2.
Osc Sync Switch	OFF, ON	Turning this switch on produces a complex sound with many harmonics. This is effective when the Osc 1 pitch is higher than the Osc 2 pitch.
Filter Type	Specifies the type of filter.	
	OFF	No filter is used.
	LPF (Low Pass Filter)	This reduces the volume of all frequencies above the cutoff frequency (Cutoff).
	BPF (Band Pass Filter)	This leaves only the frequencies in the region of the cutoff frequency, and cuts the rest.
	HPF (High Pass Filter)	This cuts the frequencies in the region below the cutoff frequency.
	PKG (Peaking Filter)	This emphasizes the frequencies in the region of the cutoff frequency.
Cutoff	0–127	Frequency at which the filter begins to have an effect on the waveform's frequency components.
Resonance	0–127	Emphasizes the portion of the sound in the region of the cutoff frequency, adding character to the sound.
LFO Rate	0–127	Adjusts the modulation speed of the LFO.
LFO Osc 1 Pitch Depth	-63–+63	Specifies the depth to which the LFO will modulate the Osc 1 pitch.
LFO Osc 2 Pitch Depth	-63–+63	Specifies the depth to which the LFO will modulate the Osc 2 pitch.

Overview

Performing

Performance Functions

Editing

Sequencer (Creating Songs)

Sampler

Pads

DAW

Settings

Appendix



For the basic procedure for system settings, refer to p. 97.

Parameter	Value	Explanation
LFO Osc 1 Pulse Width Depth	-63--+63	Specifies the depth to which the LFO will modulate the pulse width of the Osc 1 waveform. * The Pulse Width is activated when "SQR" is selected with Osc 1 waveform.
LFO Osc 2 Pulse Width Depth	-63--+63	Specifies the depth to which the LFO will modulate the pulse width of the Osc 2 waveform. * The Pulse Width is activated when "SQR" is selected with Osc 2 waveform.
Assignable		
	Specify the functions that are controlled by the [ASSIGNABLE] button.	
	OFF	No function is assigned.
	CC01-31, 32 (OFF), 33-95	Controller number 1-31, 33-95
	BEND DOWN	The same effect as moving the pitch bend lever to the right.
	BEND UP	The same effect as moving the pitch bend lever to the left.
	AFTERTOUCH	Aftertouch
	CUTOFF	Adjusts the cutoff frequency.
	RESONANCE	Adjusts the resonance.
	ATTACK	Adjusts the attack.
	RELEASE	Adjusts the release.
	PAN	Adjusts the pan.
	LEVEL	Adjusts the volume.
D-Beam Assign	EQ LOW	Adjusts the low frequency range.
	EQ MID1	Adjusts the mid-1 frequency range.
	EQ MID2	Adjusts the mid-2 frequency range.
	EQ MID3	Adjusts the mid-3 frequency range.
	EQ HIGH	Adjusts the high frequency range.
	INPUT LEVEL	Adjusts the input volume from the AUDIO INPUT jack.
	KNOB ASSIGN1-6	Adjust the [1] (ASSIGN 1)-[6] (ASSIGN 6) knobs.
	COMPRESSOR	Adjusts the compressor.
	TONE	Adjusts the tone.
	CHORUS	Adjusts the chorus.
	REVERB	Adjusts the reverb.
	TFX SELECT	Selects the total effect.
	TFX CTRL	Controls the total effect.
	SAMPLE PAD	Plays a sample.
Range Max	0-127	Specifies the upper limit of the D-BEAM controller range. MEMO By setting the Range Max below the Range Min, you can invert the range of variation.
Range Min	0-127	Specifies the lower limit of the D-BEAM controller range.
Beam Assign Knob Polarity	STANDARD, REVERSE	STANDARD: The assigned parameter changes in the positive (+) direction when you move your hand closer to the D-BEAM controller. REVERSE: The assigned parameter changes in the negative (-) direction when you move your hand closer to the D-BEAM controller.
Beam Assign Sample Pad Number	1-1-4-16	Selects the sample that plays if D-Beam Assign is set to "SAMPLE PAD."

Sound settings (Sound)

Parameter	Value	Explanation
Local Switch	OFF, ON	Enables/disables the connection between the controller section (keyboard, pitch bend/modulation lever, panel knobs and buttons, D-BEAM controller, pedals, etc.) and the internal sound engine. Normally you should leave this "ON." Choose the "OFF" setting if you want operations on the FA to control only an external sound module.
Master Tune	415.3-466.2 [Hz]	Sets the FA's overall tuning (the frequency of the A4 key).
Master Key Shift	-24+24	Shifts the FA's overall pitch range in semitone steps.
Master Level	0-127	Sets the FA's overall volume.
Output Gain	-12+12 [dB]	Adjusts the FA's overall output gain.
Tone Remain	OFF, ON	Specifies whether the currently sounding notes will remain (ON) or not (OFF) when you select a different sound. * In some cases, the effect sound might not remain. * If you switch from an organ SuperNATURAL acoustic tone, the sound will not remain even if this setting is "ON."
Sample Output Assign	MAIN, SUB	Specifies whether the sample playback sound is output from the MAIN OUTPUT jacks (MAIN) or from the SUB OUTPUT jack (SUB).
Wireless Audio Level	0-127	Adjusts the volume that is output via the wireless LAN function.
Wireless Output Assign	MAIN, SUB	When using the wireless LAN function to output the sound of the FA, this setting chooses the sound of the MAIN OUTPUT jacks (MAIN) or the sound of the SUB OUTPUT jack (SUB).

Using the Local Switch setting

If you're using a DAW software with the FA's keyboard controller section and sound generator section, you should turn the Local Switch "OFF." Here's why.

We need to connect these sections in the following order: the FA's keyboard → a DAW software → the FA's sound generator. Since the FA's keyboard section and sound generator section are connected internally, such a connection order would normally be impossible. However, if the Local Switch is "OFF," the FA's keyboard section and its sound generator section will be independent, allowing you to use a DAW software as shown here in the illustration.

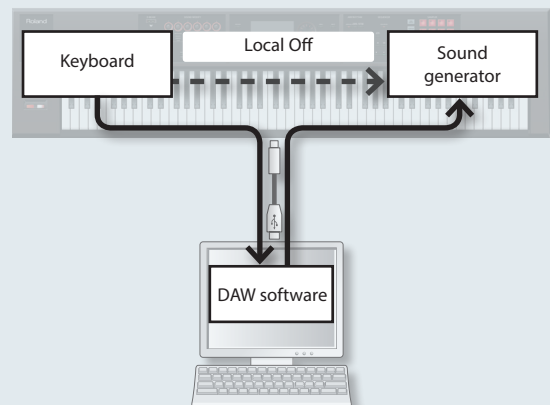



For the basic procedure for system settings, refer to p. 97.

Synchronization settings (Sync/Tempo)

Parameter	Value	Explanation
Tempo Assign Source	SYSTEM, STUDIO SET	When you switch studio sets, this setting specifies whether to use the current tempo (SYSTEM) or to use the tempo that is stored in the studio set (STUDIO SET).
Sync Mode	MASTER	The FA will be the synchronization master. Choose this setting if you're using the FA on its own without synchronizing it to another device, or if you want the tempo of an external MIDI device to synchronize with the FA.
	REMOTE	The FA will obey start, continue, stop, and song position pointer messages from another device, but the FA's own tempo setting is used as the playback tempo.
	SLAVE	The FA will be the synchronization slave. Choose this setting if you want the FA to synchronize to MIDI clock messages received from an external device.
Sync Output	OFF, ON	Specifies whether clock, start, continue, stop, and song position pointer messages are transmitted to another device (ON) or are not transmitted (OFF).
Clock Source	MIDI, USB	When the Sync Mode is "SLAVE," this setting specifies whether the FA will synchronize to synchronization messages from the MIDI IN connector or from the USB port.

Click settings (Click)

Parameter	Value	Explanation
Click Mode	Specifies how the click will be sounded.	
	OFF	No click is sounded.
	PLAY-ONLY	The click sounds when a song is playing.
	REC-ONLY	The click sounds when a song is being recorded.
	PLAY&REC	The click sounds when a song is playing or being recorded.
	ALWAYS	The click sounds at all times.
Click Level	0-10	Adjusts the click volume.
Click Sound	Selects the click sound.	
	TYPE1	Conventional metronome sound (first beat is a bell)
	TYPE2	Click sound
	TYPE3	Beep sound
	TYPE4	Cowbell sound
Click Accent Switch	OFF, ON	Adds an accent to the click sound.
Click Output Assign	MAIN, SUB	Specifies whether the click sound is output from the MAIN OUTPUT jacks (MAIN) or from the SUB OUT jack (SUB).

MIDI settings (MIDI)

Parameter	Value	Explanation
Device ID	17-32	When transmitting and receiving system exclusive messages, the device ID numbers of both devices must match.
Remote Keyboard Switch	OFF, ON	Turn this "ON" if you're using an external MIDI keyboard instead of the FA's keyboard. In this case, the MIDI transmit channel of your external MIDI keyboard does not matter. Normally, this can be left at "OFF." * If you want to control the arpeggiator from an external MIDI device, turn this "ON."
Studio Set Control Channel	1-16, OFF	Specifies the MIDI receive channel on which MIDI messages (program change/bank select) from an external MIDI device will be received by the FA to switch studio sets. Choose "OFF" setting if you don't want studio sets to be switched from a connected MIDI device.
USB-MIDI Thru	OFF, ON	Specifies whether MIDI messages received via the USB COMPUTER port/MIDI IN connector will be re-transmitted from the MIDI OUT connector/USB COMPUTER port (ON) or not be re-transmitted (OFF) (p. 102).
Transmit		
Transmit Program Change	OFF, ON	Specifies whether program change messages will be transmitted (ON) or not be transmitted (OFF).
Transmit Bank Select	OFF, ON	Specifies whether bank select messages will be transmitted (ON) or not be transmitted (OFF).
Transmit Active Sensing	OFF, ON	Specifies whether active sensing messages will be transmitted (ON) or not be transmitted (OFF).
Transmit Edit Data	OFF, ON	Specify whether changes you make in the settings of a studio set will be transmitted as system exclusive messages (ON), or will not be transmitted (OFF).
Soft Through	OFF, ON	If this is ON, MIDI messages that are input from the MIDI IN connector are re-transmitted without change from the MIDI OUT connector.
Receive		
Receive Program Change	OFF, ON	Specifies whether program change messages will be received (ON) or not be received (OFF).
Receive Bank Select	OFF, ON	Specifies whether bank select messages will be received (ON) or not be received (OFF).
Receive Exclusive	OFF, ON	Specifies whether system exclusive messages will be received (ON) or not be received (OFF).
Receive GM System On	OFF, ON	Specifies whether GM System On messages will be received (ON) or not be received (OFF).
Receive GM2 System On	OFF, ON	Specifies whether GM2 System On messages will be received (ON) or not be received (OFF).
Receive GS Reset	OFF, ON	Specifies whether GS Reset messages will be received (ON) or not be received (OFF).



For the basic procedure for system settings, refer to p. 97.

What is a MIDI?

MIDI (Musical Instrument Digital Interface) is a standard specification that allows musical data to be transferred between electronic musical instruments and computers. If a MIDI cable is connected between devices equipped with MIDI connectors, you'll be able to play multiple devices from a single MIDI keyboard, perform ensembles using multiple MIDI instruments, program the settings to change automatically as the song progresses, and more.

About MIDI connectors

The FA is equipped with the following two types of MIDI connectors, each of which has the following role.



Connector	Explanation
MIDI IN connector	This connector receives MIDI messages that are sent from an external MIDI device. When the FA receives MIDI messages, it can respond by playing notes, switching sounds, etc.
MIDI OUT connector	This connector transmits MIDI messages to an external MIDI device. Use it when you want to control an external MIDI device.

MIDI signal flow

USB-MIDI Thru = OFF

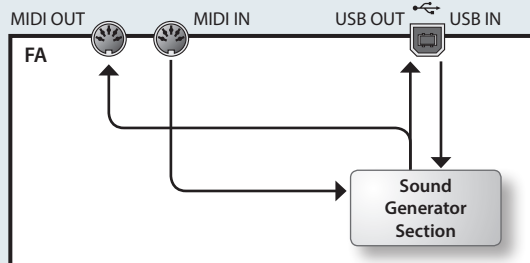

USB-MIDI Thru = ON

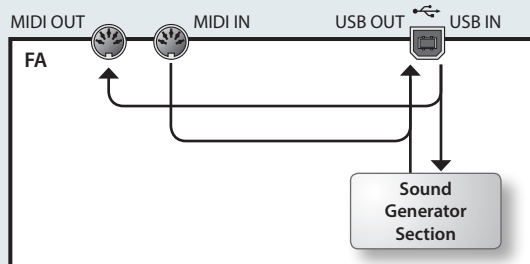

Preview settings (Preview)

Parameter	Value	Explanation
Preview Mode	SINGLE, CHORD, PHRASE	SINGLE: The notes specified by Preview 1–4 Note Number will be sounded one at a time, consecutively. CHORD: The notes specified by Preview 1–4 Note Number will be sounded simultaneously. PHRASE: The phrase provided for the corresponding patch type (category) will be played.
Preview 1–4 Note Number	0 (C)–127 (G9)	Specify the pitches of the four notes that will be sounded if you set the Preview Mode to "SINGLE" or "CHORD." * These settings are ignored if Preview Mode is set to "PHRASE."
Preview 1–4 Velocity	OFF, 1–127	Specify the velocities of the four notes that will be sounded if you set the Preview Mode to "SINGLE" or "CHORD." * These settings are ignored if Preview Mode is set to "PHRASE."

Control function settings (Control)

Parameter	Value	Explanation
Control Source Select	SYSTEM, STUDIO SET	SYSTEM: System Control Src 1–4 will be used for tone control. STUDIO SET: Tone Control Src 1–4 of the Studio Set will be used for tone control.
System Control Src1–4	OFF, CC01–31, 33–95, PITCH BEND, AFTERTOUCH	Specify the MIDI messages that will be used as system controls. System Control settings allow you to specify MIDI messages that will apply in common to the entire FA, and can be used for controlling volume, tone, etc. You can assign up to four MIDI messages for this type of control. If you want to make assignments for realtime control of the sound and effects for each tone independently, use "matrix control" or "multi-effect control." For details, refer to the "Parameter Guide" (PDF).



For the basic procedure for system settings, refer to p. 97.

Visual Control settings (Visual Control)

Parameter	Value	Explanation
Visual Control Switch	OFF, ON	Turns the Visual Control function on/off.
Visual Control Mode	MVC, V-LINK	MVC: Choose this setting if controlling a MIDI Visual Control device. V-LINK: Choose this setting if controlling a V-LINK device.
Visual Control Local Switch	OFF, ON	Specifies whether the sound of the FA is (ON) or is not (OFF) heard when you play the keyboard. * The Visual Control Local Switch setting is not saved. It will automatically be "ON" when you turn on the power.
Clip Ch	1–16	Specifies the MIDI channel used to switch images.
Effect Ch	1–16	Specifies the MIDI channel used to switch video effects.
Playback Speed Ctrl	OFF, CC01–CC31, CC64–CC95, Bender, Ch Aftertouch	Specifies the controller used to change the video playback speed.
Playback Speed Range	0.1–1.0–2.0, 0.5–1.0–2.0, 0.0–1.0–4.0, 0.5–1.0–4.0, 0.0–1.0–8.0, 0.5–1.0–8.0, 0.0–1.0–16.0, 0.5–1.0–16.0, 0.0–1.0–32.0, 0.5–1.0–32.0, 0.0–2.0–4.0, 0.0–4.0–8.0, 0.0–8.0–16.0, 0.0–16.0–32.0, -2.0–1.0–4.0, -6.0–1.0–8.0	Specifies the range in which the video playback speed will change. The three values specify the playback speed (as a multiple of normal speed) when the controller selected by Playback Speed Ctrl is at the minimum value, center value, and maximum value, respectively.
Dissolve Time Ctrl	OFF, CC01–CC31, CC64–CC95, Bender, Ch Aftertouch	Specifies the controller used to control the dissolve time (video switching time).
Effect Ctrl 1	OFF, CC01–CC31, CC64–CC95, Bender, Ch Aftertouch	Specifies the controller used to control the video effect.
Effect Ctrl 2		
Effect Ctrl 3		
Keyboard Range Lower	FA-06: C2–C7	Specifies the range of keys that will switch images.
Keyboard Range Upper	FA-07: E1–G7	
	FA-08: A0–C8	
Note Message Enabled	OFF, Assignable	Turn this "Assignable" if you want note data to switch images. Normally, program change messages are used to switch images, so you would leave this "OFF."

MEMO

You can use the function buttons to make the following settings.

Button	Explanation
[2] (MVC Sw)	Turns the Visual Control function on/off.
[3] (Send Reset)	Sends a reset all controllers message to the MIDI Visual Control device.
[4] (Local Sw)	Turns the Visual Control Local Switch on/off.

What is MIDI Visual Control?

MIDI Visual Control is an internationally-used recommended practice that was added to the MIDI specification so that visual expression could be linked with musical performance Video equipment that is compatible with MIDI Visual Control can be connected to electronic musical instruments via MIDI in order to control video equipment in tandem with a performance.



What is V-LINK?

V-LINK is Roland's proprietary specification that allows visual expression to be linked with musical performance Video equipment that is compatible with V-LINK can be connected to electronic musical instruments via their MIDI ports, making it easy to enjoy a variety of visual effects that are linked with the performance.



Connection examples

Connect a MIDI cable from this unit's MIDI Out connector to the MIDI In connector of your Visual Control or V-LINK compatible device.

* You'll need a MIDI cable (sold separately) in order to connect this unit to a device that supports Visual Control.

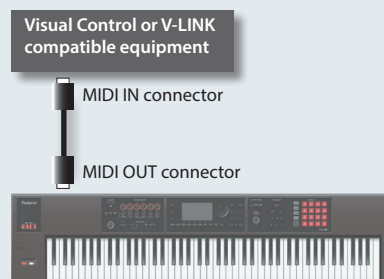

Information about the FA itself (Information)

Here you can view the software version of the FA and the status of expansion sounds.

Display	Explanation
System Version	Displays the FA's software version.
Expansion	Displays information about expansion sounds. MEMO A wide variety of tones from the Axial sound library site can be added to the FA.

What is Wireless LAN Function?

By inserting the wireless USB Adapter (WNA1100-RL; sold separately) into the FA's USB FOR UPDATE port, you'll be able to use wireless-compatible applications (such as the "Air Recorder" iPhone app).

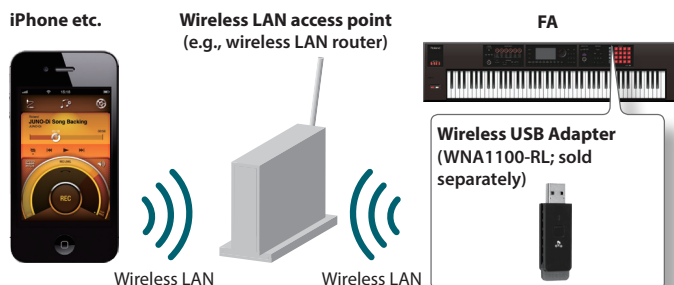

Items required to use the wireless LAN function

- Wireless USB Adapter (WNA1100-RL; sold separately)
- Wireless LAN access point (e.g., wireless LAN router) *1 *2 *3
- iPhone or iPod touch etc.

- *1 The wireless LAN access point you use must support WPS. If your wireless LAN access point does not support WPS, you can connect using the procedure described in "Connecting to a Wireless LAN Access Point That You Select (SELECT ACCESS POINT)" (p.105).
- *2 The ability to connect with all kinds of wireless LAN access points is not guaranteed.
- *3 If you're unable to connect to the wireless LAN access point, try connecting using Ad-Hoc mode (p. 106).

Basic Connection Method (Connect by WPS)

The first time you connect the FA to a wireless network, you'll need to perform the following procedure (WPS) to join the wireless network.

This procedure is required only the first time. (Once you've joined the network, this procedure will no longer be necessary.)

What is WPS?

This is a standard that makes it easy to make security settings when connecting to a wireless LAN access point. We recommend that you use WPS when connecting to a wireless LAN access point.

1. Insert the wireless USB Adapter (WNA1100-RL; sold separately) into the FA's USB MEMORY port.

NOTE

Never turn off the power or disconnect the wireless USB Adapter while the screen indicates "Processing..."

2. Select the [MENU] button → "Wireless" → "WPS."

The WPS screen appears.

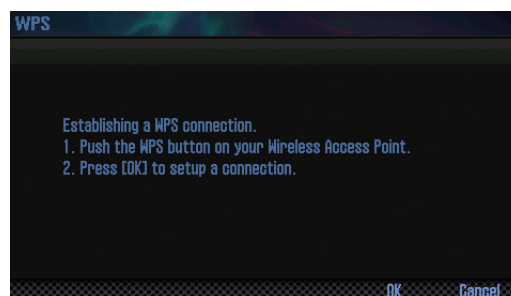

3. Perform the WPS operation on your wireless LAN access point (e.g., press the WPS button on your wireless LAN access point).

For details on WPS operation of your wireless LAN access point, refer to the documentation for your wireless LAN access point.

4. Press the [6] (OK) button of the FA.

Once successfully connected, the status (WIRELESS STATUS) screen (p. 105) appears.

5. Press the [EXIT] button to return to the top screen.

You can use the wireless connection from an iPhone app such as Air Recorder. Choose "FA-06 08" in the instrument select screen of your iPhone app.

NOTE

The device (e.g., iPhone) running the app must be connected to the same network.

MEMO

- The connection data is stored in memory when you perform the WPS procedure; the device will automatically connect to the wireless network the next time.
- All connection data will be erased if you perform a factory reset.
- Connection data is not included in a backup saved in the SD card.

Icons in the display

The wireless LAN status is shown in the upper part of the display.

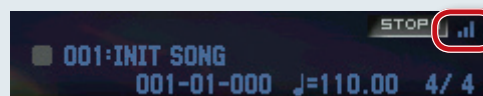

Icon	Explanation
	Currently connected to the wireless LAN access point. Three bars are used to indicate the signal level (the strength of the connected wireless LAN access point's radio signal).
	The wireless USB adapter is inserted, but not connected with a wireless LAN access point.
	The wireless USB adapter is not inserted (nothing is displayed).
	Ad-Hoc mode (p. 106).

Wireless LAN Function Settings

You can view or edit the wireless settings.

Status Indication (WIRELESS STATUS)

This shows the wireless LAN status.

1. Select the [MENU] button → “Wireless.”

The WIRELESS STATUS screen appears.

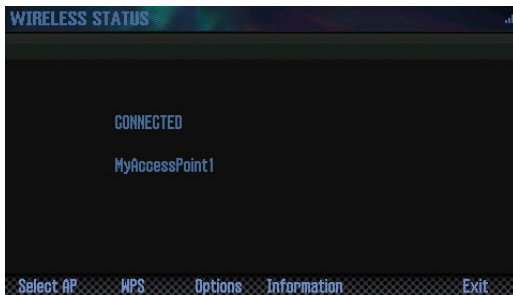

Display	Explanation
CONNECTED	Currently connected to the wireless LAN access point. The identifier (name) of the connected wireless LAN access point is shown.
NOW CONNECTING	A connection with the wireless LAN access point is being established.
NOT CONNECTED	The wireless USB adapter is inserted, but not connected to a wireless LAN access point.
NOT AVAILABLE	The wireless USB adapter is not inserted.
AD-HOC MODE	Ad-Hoc mode. The Ad-Hoc SSID and Ad-Hoc Key are shown. For details, refer to “Connecting in Ad-Hoc mode (Ad-Hoc Mode)” (p.106).

What the function buttons do

Button	Explanation
[2] (Select AP)	Move to a screen where you can choose a wireless LAN access point and connect to it.
[3] (WPS)	Move to a screen for performing WPS.
[4] (Options)	Make settings for Wireless ID or Ad-Hoc mode (p. 106).
[5] (Information)	View the IP address and MAC address.

Connecting to a Wireless LAN Access Point That You Select (SELECT ACCESS POINT)

This method lets you connect by choosing a wireless LAN access point from the list that is displayed.

* Wireless standards 802.11g/n (2.4 GHz) and authentication methods WPA/WPA2 are supported.

1. Select the [MENU] button → “Wireless” → “Select AP.”

The SELECT ACCESS POINT screen appears.

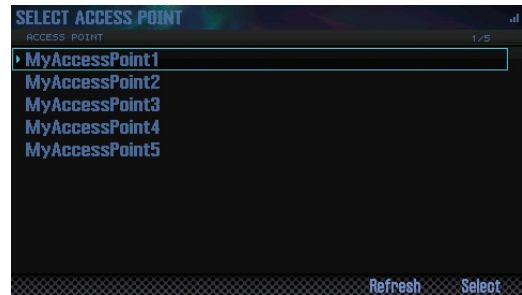

- A “▶” symbol is shown for the currently-connected wireless LAN access point.
- You can update the list by pressing the [6] (Refresh) button.

2. Choose the wireless LAN access point to which you want to connect, and press the [7] (Select) button.

- You will be connected to the selected wireless LAN access point.
- If you’re using this wireless LAN access point for the first time, you’ll proceed to the authorization (WIRELESS STATUS) screen.
- If this is a wireless LAN access point to which you have connected in the past, just press the [7] (Select) button and you’ll be connected. Once successfully connected, you’ll be returned to the status (Wireless Status) screen.

Authorization screen (AUTHORIZATION)

3. Enter the security code (passphrase) of your wireless LAN access point, and press the [7] (OK) button.

For details on how to enter characters, refer to “Saving a Studio Set” (p.45).

* You cannot enter a space at the end of the passphrase.

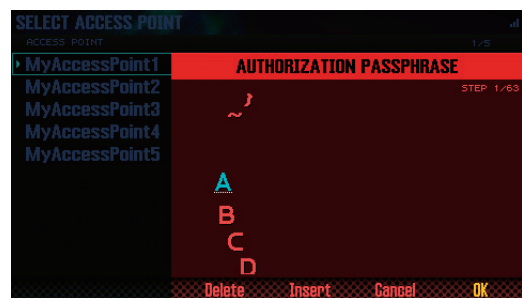

Once successfully connected, you’ll be returned to the status (WIRELESS STATUS) screen.

- Overview
- Performing
- Performance Functions
- Editing
- Sequencer (Creating Songs)
- Sampler
- Pads
- DAW
- Settings
- Appendix

Other Settings (WIRELESS OPTIONS)

Make settings for Wireless ID or Ad-Hoc mode.

1. Select the [MENU] button → “Wireless” → “Options.”

The WIRELESS OPTIONS screen appears.

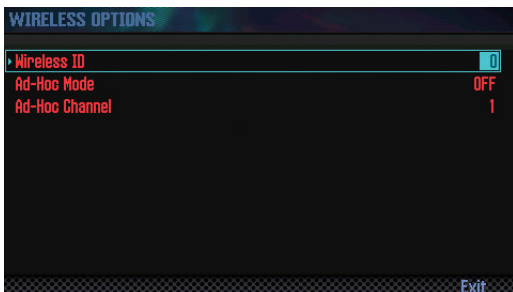

Parameter	Explanation
Wireless ID	<p>Specifies the final digits of the FA's device name and Ad-Hoc SSID (FA) that will be shown as the instrument in the wirelessly connected app.</p> <p>Normally, you should specify “0,” but if you have more than one of the same instrument, you can set the Wireless ID in the range of 1–99 to change the device name and Ad-Hoc SSID for each instrument, as follows.</p> <ul style="list-style-type: none"> If Wireless ID = 0, “FA-06 08” (default value) If Wireless ID = 1, “FA-06 08_1” : If Wireless ID = 99, “FA-06 08_99”
Ad-Hoc Mode	Turns Ad-Hoc mode on/off.
Ad-Hoc Channel	Specifies the channel (1–11) for Ad-Hoc mode.

1. Select the [MENU] button → “Wireless” → “Options.”

The WIRELESS OPTIONS screen appears.

2. Turn the Ad-Hoc Mode “ON.”

You can use Channel to specify a channel (1–11) for Ad-Hoc mode. Normally, you won't need to change the channel. Try changing the channel only if you have problems connecting.

3. Press the [EXIT] button to access the WIRELESS STATUS screen.

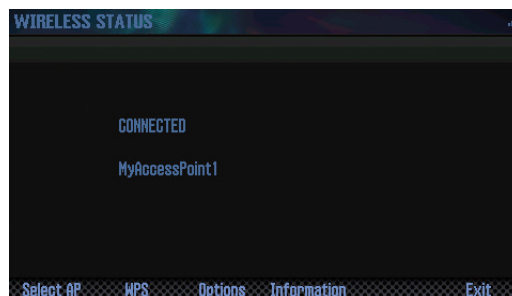

The Ad-Hoc SSID (FA-06 08) and the Ad-Hoc Key (a five-character text string) will be displayed.

MEMO

The Ad-Hoc SSID (FA-06 08) will be the value that you specified in the WIRELESS OPTIONS screen “Wireless ID” setting.

4. On the iPhone or other wireless device that you want to connect, select the Ad-Hoc SSID shown in the above screen to make the connection. (For example, on an iPhone, choose [Settings] → [Wi-Fi] → [Choose a Network] to select the above Ad-Hoc SSID. A password entry screen appears; enter the above Ad-Hoc key.)

For details on how to connect to a wireless LAN from an iPhone or other device, refer to the owner's manual of that device.

5. When you want to end the Ad-Hoc mode connection, restore the iPhone settings in [Settings] → [Wi-Fi] → [Choose a Network] to their previous state.

Connecting in Ad-Hoc mode (Ad-Hoc Mode)

Here's how to connect in Ad-Hoc mode.

What is Ad-Hoc mode?

Ad-Hoc mode lets you connect the FA directly to an iPhone or other wireless device without using a wireless LAN access point. This is a convenient way to use the FA with an iPhone or other wireless device if you're in a location where the wireless LAN access point you normally use is unavailable, such as when you're away from home.

iPhone etc.



FA



Limitations

The iPod touch or other wireless device connected in Ad-Hoc mode will be unable to communicate with the Internet or with another wireless device. However, an iPhone or other wireless device that has cellular capability will be able to connect to the Internet via the cellular connection.

Please be aware that if you use a cellular connection for Internet connectivity, you may incur costs depending on your rate plan.

Checking the IP Address and MAC Address (WIRELESS INFORMATION)

Here's how to check the IP address and MAC address.

1. Select the [MENU] button → “Wireless” → “Information.”

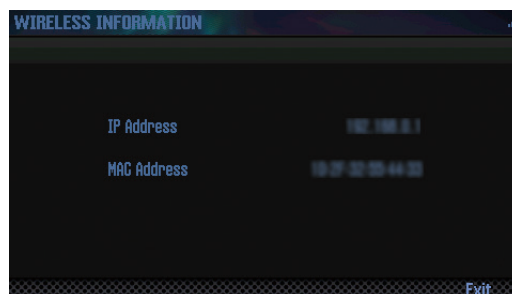

MEMO

The MAC address shows the value indicated on the bottom of the wireless USB adapter (WNA1100-RL; sold separately).



10: Appendix

Provides troubleshooting information and lists error messages.

About SD Cards.....	108
Chord Memory List	109
Block Diagram.....	111
Error Message List	112
Troubleshooting.....	113
MIDI Implementation Chart.....	118
Main Specifications	120

About SD Cards

When using a commercially available SD card, insert it as follows.

1. Remove the screws from the rear panel SD card protector.

When this unit is shipped from the factory, the SD card protector screws are installed as shown in the illustration. To remove the card protector, you must first use a phillips screwdriver to remove the screws.

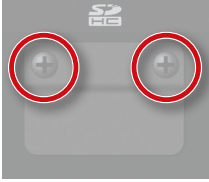

NOTE

- Never turn off the power or disconnect the SD cards while the screen indicates **"Processing..."**
- Never remove the SD card while the writing is in progress.

2. Pull out the included SD card, insert your SD card into the slot, and then reattach the SD card protector.

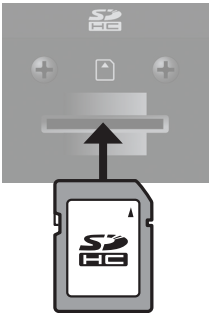

- * Some SD card types or SD cards from some manufacturers may not record or play back properly on the FA.
- * All SD cards eventually wear out. We recommend that you consider the SD card not as a permanent storage site, but as a place to store data temporarily. We also recommend that you back up important data onto the another media that is supported by your unit.

Preparing an SD card for use

When using a commercially available SD card with the FA, you must first format it as described in **"Initializing an SD Card (Format SD Card)"** (p.96). However, **don't format the SD card that's included with the FA**. If you format the included SD card, you'll lose all of the demo song data that was on the card.

Once you format an SD card, the data that used to be on it cannot be recovered. We recommend that you back up the data as described in **"Backing-Up SD Card Data to a Computer"** (p.96).

The memory card write protect feature (LOCK)

The contents of the memory card can be protected by write protecting it.

To write protect a card, slide the write protect switch on the side of the memory card to the **"LOCK"** position. Unlock write protect to delete data on the card.

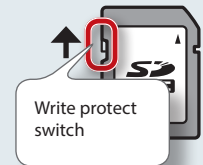

The folder structure of an SD card

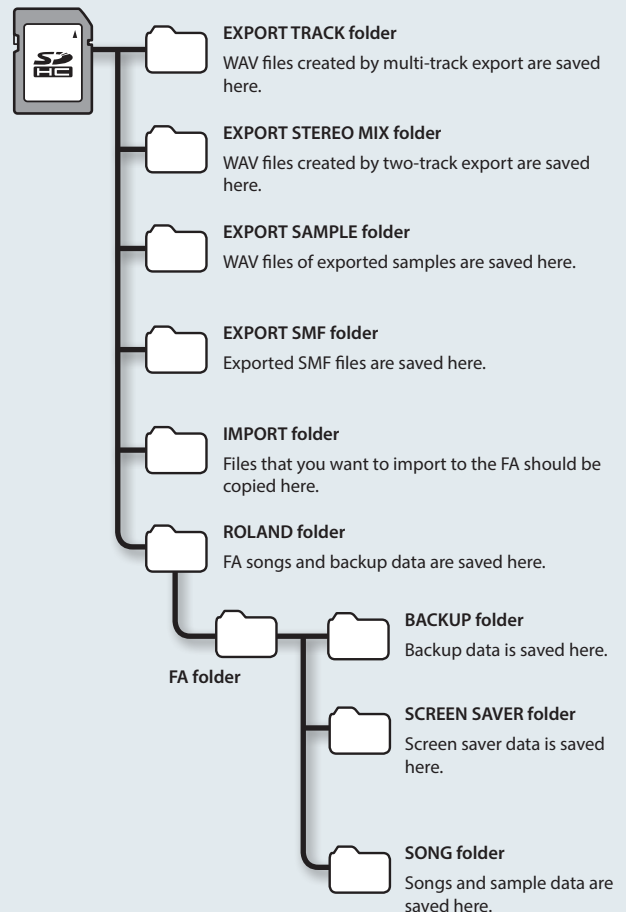

Chord Memory List

01: Pop 1

Assign Key	Chord Name	Constituent Notes of Chord Forms
C	Cadd9	C3, G3, D4, E4
C#	C#maj9	C#3, C4, D#4, F4
D	D-7	D3, F4, A3, C4
D#	D#maj7	D#3, A#3, D4, G4
E	Cadd9 (on E)	E3, C4, D4, G4
F	Fmaj9	F2, A3, E4, G4
F#	Dadd9 (on F#)	F#2, A3, D4, E4
G	Cadd9 (on G)	G2, D4, E4, G4
G#	F-6 (on Ab)	G#2, C4, D4, F4
A	F (on A)	A2, A3, C4, F4
A#	G- (on Bb)	A#2, A#3, D4, G4
B	G (on B)	B2, B3, D4, G4

02: Pop 2

Assign Key	Chord Name	Constituent Notes of Chord Forms
C	Cmaj9	C3, E3, B3, D4
C#	C#dim7	C#3, G3, A#3, E4
D	D-9	D3, F3, C4, E4
D#	D#dim7	D#3, A3, C4, F#4
E	E-7	E3, B3, D4, G4
F	Fmaj9	F3, A3, E4, G4
F#	F#-7 (b5)	F#3, A3, C4, E4
G	G7sus4 (9 13)	G2, A3, C4, F4
G#	G#dim7	G#2, B3, D4, F4
A	A-9	A2, B3, C4, G4
A#	C7(on Bb)	A#2, G3, C4, E4
B	B-7(b5)	B2, A3, D4, F4

03: Jazz 1

Assign Key	Chord Name	Constituent Notes of Chord Forms
C	C6 9	C3, E3, A3, D4
C#	C#7(#9)	C#3, F3, B3, E4
D	D-9	D3, F3, C4, E4
D#	D#7(#9)	D#3, G3, C#4, F#4
E	E#7(#9)	E3, G#3, D4, G4
F	Fmaj9	F3, A3, E4, G4
F#	F#7(#9)	F#3, A#3, E4, A4
G	G7(13)	G2, F3, B3, E4
G#	G#7(13)	G#2, F#3, C4, F4
A	A-7(11)	A2, G3, C4, D4
A#	Bb9	A#2, G#3, C4, D4
B	B-7(11)	B2, A3, D4, E4

04: Jazz 2

Assign Key	Chord Name	Constituent Notes of Chord Forms
C	C6 9	C3, E3, A3, D4
C#	C#9	C#3, F3, B3, D#4
D	D-9	D3, F3, C4, E4
D#	D#9	D#3, G3, C#4, F4
E	E-9	E3, G3, D4, F#4
F	F-9	F2, G#3, D#4, G4
F#	F#-7(b5)	F#2, A3, C4, E4
G	G7(b13)	G2, F3, B3, D#4
G#	G#7(13)	G#2, F#3, C4, F4
A	A7(b13)	A2, G3, C#4, F4
A#	Bb7(13)	A#2, G#3, D4, G4
B	B-7(11)	B2, A3, D4, E4

05: Jazz 3

Assign Key	Chord Name	Constituent Notes of Chord Forms
C	Cmaj9	C3, E3, G3, B3, D4
C#	Dbmaj7	C#3, F3, G#3, C4, D#4
D	Dmaj9	D3, F#3, A3, C#4, E4
D#	Ebmaj9	D#3, G3, A#3, D4, F4
E	Emaj9	E3, G#3, B3, D#4, F#4
F	Fmaj9	F3, A3, C4, E4, G4
F#	Gbmaj9	F#3, A#3, C#4, F4, G#4
G	Gmaj9	G3, B3, D4, F#4, A4
G#	Abmaj9	G#3, C4, D#4, G4, A#4
A	Amaj9	A3, C#4, E4, G#4, B4
A#	Bbmaj9	A#3, D4, F4, A4, C5
B	Bmaj9	B3, D#4, F#4, A#4, C#5

06: Blues

Assign Key	Chord Name	Constituent Notes of Chord Forms
C	C7(9)	C3, A#3, D4, E4
C#	C#7(9)	C#3, F3, B3, D#4
D	D7(9)	D3, F#3, C4, E4
D#	D#7(9)	D#3, G3, C#4, F4
E	E7(#9)	E3, G#3, D4, G4
F	F7(9)	F2, A3, D#4, G4
F#	F#dim7	F#2, A3, C4, D#4
G	G7(13)	G2, F3, B3, E4
G#	G#dim7	G#2, B3, D4, F4
A	A7(b13)	A2, G3, C#4, F4
A#	Bb7(13)	A#2, G#3, D4, G4
B	B-7(b5)	B2, A3, D4, F4

07: Trad Maj

Assign Key	Chord Name	Constituent Notes of Chord Forms
C	C	C3, E4, G4, C5
C#	C#dim7	C#3, E4, G4, A#4
D	D-	D3, D4, F4, A4
D#	D#dim7	D#3, F#4, A4, C5
E	E-	E3, E4, G4, B4
F	F	F3, F4, A4, C5
F#	F#-7(b5)	F#3, E4, A4, C5
G	G	G3, D4, G4, B4
G#	G#dim7	G#3, D4, F4, B4
A	A-	A2, E4, A4, C5
A#	Bb	A#2, D4, F4, A#4
B	Bdim	B2, D4, F4, B4

08: Trad Min 1

Assign Key	Chord Name	Constituent Notes of Chord Forms
C	C-	C3, D#4, G4, C5
C#	Db	C#3, C#4, F4, G#4
D	Ddim	D3, D4, F4, G#4
D#	Eb	D#3, D#4, G4, A#4
E	Edim7	E3, C#4, G4, A#4
F	F-	F2, C4, F4, G#4
F#	Gbdim7	F#2, C4, D#4, A4
G	G-	G2, A#3, D4, G4
G#	Ab	G#2, C4, D#4, G#4
A	A-7(b5)	A2, C4, D#4, G4
A#	Bb	A#2, D4, F4, A#4
B	Bdim7	B2, D4, F4, G#4

09: Trad Min 2

Assign Key	Chord Name	Constituent Notes of Chord Forms
C	C-	C3, D#4, G4, C5
C#	Db	C#3, C#4, F4, G#4
D	Ddim	D3, D4, F4, G#4
D#	Eaug	D#3, D#4, G4, B4
E	E-	E3, E4, G4, B4
F	F-	F2, C4, F4, G#4
F#	Gbdim7	F#2, C4, D#4, A4
G	G-	G2, B3, D4, G4
G#	Ab	G#2, G#4, D#4, C4
A	A-7(b5)	A2, C4, D#4, G4
A#	Bb	A#2, D4, F4, A#4
B	Bdim	B2, D4, F4, B4

10: Pop Min 1

Assign Key	Chord Name	Constituent Notes of Chord Forms
C	C-add9	C3, D4, D#4, G4
C#	Dbmaj7	C#3, G#3, C4, F4
D	D-7(b5)	D3, C4, F4, G#4
D#	Ebmaj7	D#3, A#3, D4, G4
E	Edim7	E3, A#3, C#4, G4
F	F-7(9)	F2, G#3, D#4, G4
F#	Gbdim7	F#2, A3, C4, D#4
G	G-7	G2, A#3, D4, F4
G#	Abmaj7	G#2, C4, D#4, G4
A	A-7(b5)	A2, C4, D#4, G4
A#	Bb7sus4(9 13)	A#2, G#3, C4, D#4
B	Bdim7	B2, G#3, D4, F4

Overview

Performing

Performance Functions

Editing

Sequencer (Creating Songs)

Sampler

Pads

DAW

Settings

Appendix

Chord Memory List

11: Pop Min 2

Assign Key	Chord Name	Constituent Notes of Chord Forms
C	C-add9	C3, D4, D#4, G4
C#	Eb7(on Db)	C#3, A#3, D#4, G4
D	D-7(b5)	D3, G#3, C4, F4
D#	Ebmaj7	D#3, A#3, D4, G4
E	Emaj7(9)	E3, G#3, D#4, F#4
F	F-7(9)	F2, G#3, D#4, G4
F#	Gbdim7	F#2, A3, C4, D#4
G	G7(b13)	G2, F3, B3, D#4
G#	Abmaj7	G#2, C4, D#4, G4
A	A-7(b5)	A2, C4, D#4, G4
A#	C-7(on Bb)	A#2, C4, D#4, G4
B	C-maj7(B)	B2, D4, D#4, G4

12: Jazz Min 1

Assign Key	Chord Name	Constituent Notes of Chord Forms
C	C-7(11)	C3, A#3, D#4, F4
C#	Db7(#9)	C#3, F3, B3, E4
D	D-7(b5)	D3, C4, F4, G#4
D#	Ebaug maj7	D#3, B3, D4, G4
E	E7(9)	E2, G#3, D4, F#4
F	F7(9)	F2, A3, D#4, G4
F#	Gbdim7	F#2, A3, C4, D#4
G	G7(#9)	G2, B3, F4, A#4
G#	Abmaj7(#11)	G#2, C4, D4, G4
A	A-7(b5)	A2, C4, D#4, G4
A#	Bb-7	A#2, G#3, C#4, F4
B	Bdim7	B2, G#3, D4, F4

13: Jazz Min 2

Assign Key	Chord Name	Constituent Notes of Chord Forms
C	C-7(9)	C3, D#3, A#3, D4
C#	Db7(9)	C#3, F3, B3, D#4
D	D-7(9)	D3, F3, C4, E4
D#	Eb7(9)	D#3, G3, C#4, F4
E	Emaj7(9)	E2, G#3, D#4, F#4
F	F-7(9)	F2, G#3, D#4, G4
F#	Gbdim7	F#2, A3, C4, D#4
G	G7(13)	G2, F3, B3, E4
G#	Ab-6	G#2, B3, D#4, F4
A	A-7(b5)	A2, C4, D#4, G4
A#	Bb-7	A#2, G#3, C#4, F4
B	B-7(b5)	B2, A3, D4, F4

14: Oct Stack

Assign Key	Chord Name	Constituent Notes of Chord Forms
C	---	C4, C5
C#	---	C#4, C#5
D	---	D4, D5
D#	---	D#4, D#5
E	---	E4, E5
F	---	F4, F5
F#	---	F#4, F#5
G	---	G4, G5
G#	---	G#4, G#5
A	---	A4, A5
A#	---	A#4, A#5
B	---	B4, B5

15: 4th Stack

Assign Key	Chord Name	Constituent Notes of Chord Forms
C	---	C4, F4
C#	---	C#4, F#4
D	---	D4, G4
D#	---	D#4, G#4
E	---	E4, A4
F	---	F4, A#4
F#	---	F#4, B4
G	---	G4, C5
G#	---	G#4, C#5
A	---	A4, D5
A#	---	A#4, D#5
B	---	B4, E5

16: 5th Stack

Assign Key	Chord Name	Constituent Notes of Chord Forms
C	---	C4, G4
C#	---	C#4, G#4
D	---	D4, A4
D#	---	D#4, A#4
E	---	E4, B4
F	---	F4, C5
F#	---	F#4, C#5
G	---	G4, D5
G#	---	G#4, D#5
A	---	A4, E5
A#	---	A#4, F5
B	---	B4, F#5

17: Scale Set

Assign Key	Chord Name	Constituent Notes of Chord Forms
C	Major Scale	C4, D4, E4, F4, G4, A4, B4
C#	Major Pentatonic Scale	C4, D4, E4, G4, A4
D	Minor Scale	C4, D4, D#4, F4, G4, G#4, A#4
D#	Harmonic Minor Scale	C4, D4, D#4, F4, G4, G#4, B4
E	Melodic Minor Scale	C4, D4, D#4, F4, G4, A4, B4
F	Whole Tone Scale	C4, D4, E4, F#4, G#4, A#4
F#	Blue note Scale	C4, D#4, F4, F#4, G4, A#4
G	Japanese Minor	C4, C#4, F4, G4, A#4
G#	Ryukyu Scale	C4, E4, F4, G4, B4
A	Bari Scale	C4, C#4, D#4, G4, G#4
A#	Spanish Scale	C4, C#4, E4, F4, G4, G#4, A#4
B	Gypsy Scale	C4, C#4, E4, F4, G4, G#4, B4

* To change the key of a chord set, change the value for "KEY" in the "CHORD MEMORY" screen.

The illustration below shows how to determine the key of the song from the key signature (the number of # and b symbols).

Major C F B^b E^b A^b D^b G^b

Minor Am Dm Gm Cm Fm B^bm E^bm

Major G D A E B F[#]

Minor Em Bm F[#]m C[#]m G[#]m D[#]m

Block Diagram

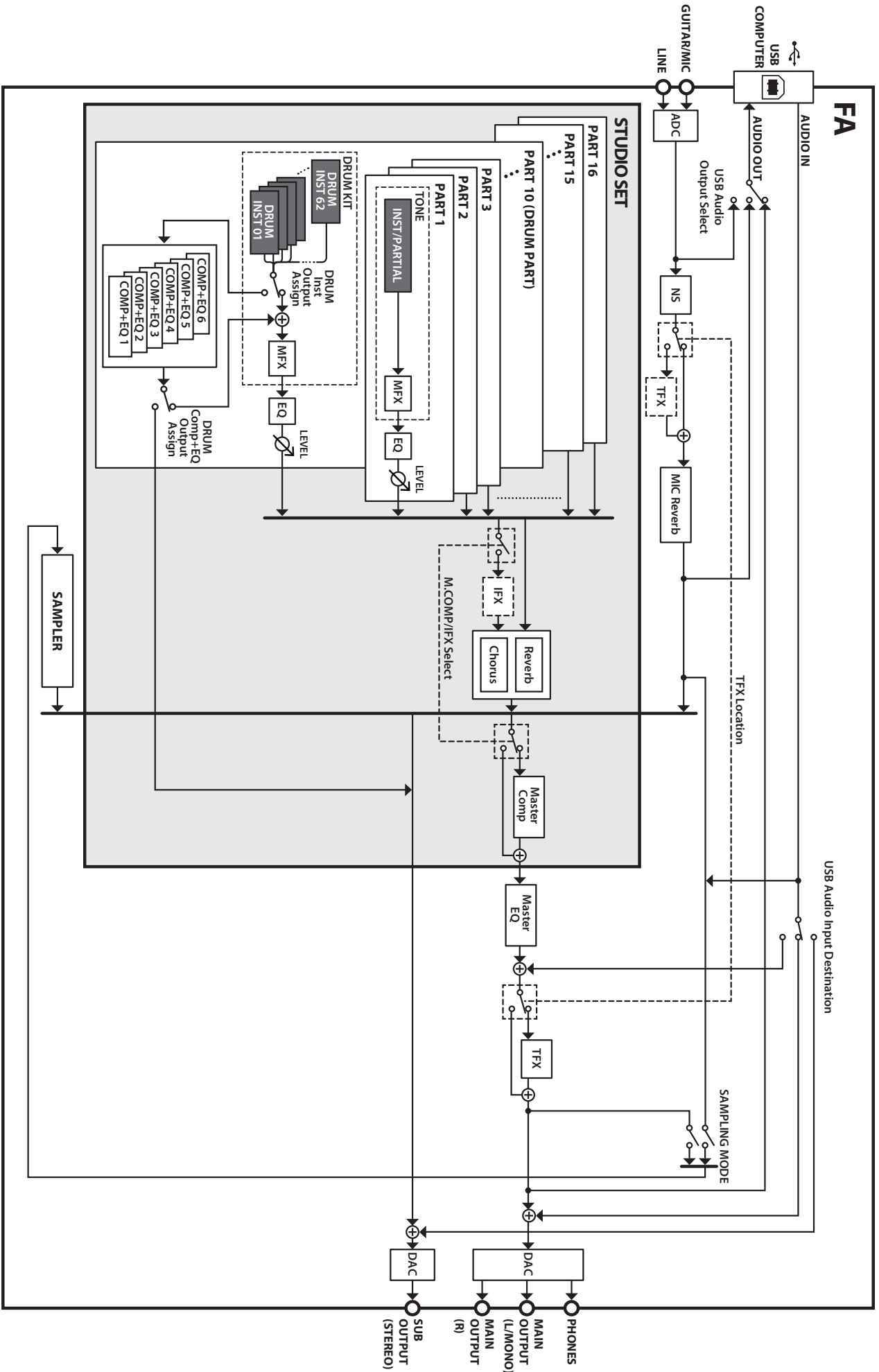

Error Message List

If an incorrect operation is performed, or if processing could not be performed as you specified, an error message appears. Refer to the explanation for the error message that appears, and take the appropriate action.

Message	Meaning	Action
Cannot Import!	Sound data cannot be imported.	An import destination has not been selected. Select the import destination (p. 95).
File Not Selected!	No file is selected.	Select a file.
Incorrect File!	This is a file that the FA is unable to play.	Do not use this file.
	The audio file format is invalid.	Use a WAV/AIFF file that complies with the guidelines (p. 16).
	The format of an SMF you intend to import to an arpeggio style or rhythm pattern must be Format 0.	Make sure that the SMF you're importing is in Format 0.
	The SMF you attempted to import cannot be loaded into the FA.	SMF data that contains a time signature other than the time signature specified in the Pattern Time Signature (p. 50) setting cannot be loaded by the FA. You need to change the time signature data of the SMF.
Memory Damaged!	The contents of internal memory may have been damaged.	Execute the factory reset operation (p. 95). If this does not solve the problem, contact your dealer or customer support.
MIDI Buffer Full!	An unusually large amount of MIDI data was received, and could not be processed.	Reduce the amount of MIDI messages that are being transmitted.
MIDI Offline!	The MIDI IN connection was broken.	Check that there is no problem with the MIDI cable connected to the FA's MIDI IN, and that the MIDI cable was not disconnected.
Now Playing!	Since the FA is playing, this operation cannot be executed.	Stop playback before you execute the operation.
Now Recording!	Since the FA is recording, this operation cannot be executed.	Stop recording before you execute the operation.
Permission Denied!	The operation could not be performed because the read-only attribute is set for the folder or file.	Use your computer to clear the read-only attribute of the file or folder.
Program Error!	The FA was unable to start up.	Use the correct program to perform the update once again.
	The program could not be read correctly. Alternatively, the system update program may be invalid.	If this does not solve the problem, contact your dealer or customer support.
Read Error!	Data could not be read from the SD card.	Make sure that SD card is correctly inserted (p. 108).
	The file is damaged.	Do not use this file.
Rec Length Too Long!	The allowable sampling time has been exceeded.	–
	The allowable number of measures for realtime recording has been exceeded.	–
Rec Over Flow	Since a large amount of recorded data was input all at once, it could not be processed correctly.	Reduce the amount of recorded data.
Rhythm Pattern Full!	The maximum number of notes that can be recorded in one rhythm pattern has been exceeded; the rhythm pattern cannot be recorded any further.	Delete unneeded data from the rhythm pattern that you're recording.
Sample Length Too Short!	The sample is too short, and cannot be edited correctly.	If the sample is extremely short, editing may not produce the desired result.
Song Full!	Since the maximum number of notes that can be recorded in a song or phrase has been exceeded, no further recording/editing is possible.	Use the Track Modify operations Delete or Erase to remove unneeded data from the song that you're recording or editing (p. 64).
System Memory Damaged!	The contents of system memory may be damaged.	Execute the factory reset operation (p. 95). If this does not solve the problem, contact your dealer or customer support.
SD Card Error!	The SD card format is invalid.	Use the FA to format the SD card (p. 96).
	Data cannot be read from the SD card.	Make sure that the SD card is correctly inserted (p. 108).
	Data cannot be written to the SD card.	
SD Card Full!	There is insufficient space on the SD card.	Delete unneeded data (p. 73).
SD Card Locked!	Writing or erasure are not possible because the SD card is locked.	Turn off the power, remove the SD card, and unlock it.
SD Card Not Ready!	The SD card is not inserted, or is inserted incompletely.	Turn off the unit, firmly insert the SD card, and then turn on the unit once again (p. 19, p. 108).
	The SD card was removed after you selected data that was on the SD card.	
	The format of the SD card is invalid.	Use the FA to format the SD card (p. 96).
Too Much Data!	The SMF you're importing to an arpeggio style or rhythm pattern contains too much data.	Keep the SMF data within 500 notes (note-on/off) for an arpeggio style, and within 4,000 events for a rhythm pattern.
You Cannot Erase	This message cannot be erased.	–
Write Error!	Data could not be written to the SD card.	Make sure that SD card is correctly inserted (p. 108).
	The format of the SD card is invalid.	Use the FA to format the SD card (p. 96).

Troubleshooting

Problem	Items to check	Action	Page
Overall problems			
The unit turns off unexpectedly	Check the "Auto Off" system setting.	The FA will automatically be turned off when no operation has been performed for a certain length of time. (At the factory settings, the power will be turned off after 4 hours.) If you want the FA to stay on, change the "Auto Off" system setting to "OFF."	p. 97
Power won't turn on	Are the included AC adaptor and power cord correctly connected to an outlet and to the FA?	Do not use any AC adaptor or power cord other than the supplied items. Doing so will cause malfunctions.	p. 8
Problems with the sound			
No sound	Is the connected amp or speaker powered up?	Turn on the power of the connected amp or speaker.	–
	Could the volume of a connected device have been lowered?	Adjust the volume of the connected equipment.	–
	Could the [VOLUME] knob be set to the minimum level?	Adjust the [VOLUME] knob.	p. 19
	Are your amp, speakers, headphones, etc., connected correctly?	Correctly connect your amp, speakers, and headphones.	p. 8
	Can you connect headphones and hear sound through them?	If you hear sound through your headphones, it may be that there is a broken connection cable, or that your amp or mixer have malfunctioned. Check your connection cables and equipment once again.	–
	Are the settings for the output destination correct?	Check the various Output Assign settings. For details on the parameters, refer to "Parameter Guide" (PDF).	–
	Could you be using a connection cable that contains a resistor?	Use a connection cable that does not contain a resistor.	–
	If pressing the keyboard does not produce sound, could the Local switch be turned off?	Turn the Local Switch "ON."	p. 100
	Could the tone's partials be turned off?	Turn the Partial Switch "ON."	p. 49
	Could the level setting be too low?	In the Sound system settings, check the Master Level setting.	p. 100
	Are the effect settings correct?	Check the effect on/off settings. Also check settings such as the effect levels.	p. 52
	Has the expansion sound data been loaded correctly?	If the settings of the sound use a tone, wave, or instrument of an expansion sound, make sure that the corresponding expansion sound data is loaded correctly.	p. 103
	Could the volume have been lowered by a pedal operation, a D-BEAM controller operation, or a MIDI message (volume or expression) received from an external MIDI device?	Adjust the Level setting to raise the volume of the part that you don't hear. Step on the pedal, move your hand above the D-BEAM controller, and check settings of the other controllers. Adjust the Level setting to raise the volume of the part that you don't hear. Check the expression messages that are being transmitted by your external MIDI device.	p. 44
No sound from a specific part	Could the volume of the part have been lowered?	Adjust the Level setting to raise the volume of the part that you don't hear.	p. 44
	Could the part be muted?	Turn the mute off.	
	Could the part be assigned as the pad part?	If a part is assigned as the pad part, it will not play the sound engine. Check the pad part setting.	p. 58
	Could the Rx Switch of the part be turned off?	Turn the Rx Switch "ON."	p. 44
No sound from a specific range of keys	Could a key range be set?	If you don't hear sound from a specific range of keys, check the key range settings.	p. 44
Sound is distorted	Could you be applying an effect that intentionally distorts the sound?	If the sound of a specific tone or part is distorted, lower the volume of that tone or part.	p. 44, p. 46
	Could the [VOLUME] knob be set too high?	If the overall sound is distorted, lower the [VOLUME] knob.	p. 19
	Could the Output Gain be raised excessively?	In the Sound system settings, check the Output Gain setting.	p. 100
	Could a system effect be applied?	It may be that the Master EQ or TFX settings are making the sound distort. Check the Master EQ and TFX settings.	p. 54
Pitch is wrong	Could the FA's tuning be incorrect?	In the Sound system settings, check the Master Tune setting.	p. 100
	Could the pitch have been changed by a pedal operation or by a pitch bend message received from an external MIDI device?	Check the pedal and the pitch bender.	p. 41, p. 42
	Could the Coarse Tune, Fine Tune, or Master Tune parameters be set?	Check the Coarse Tune, Fine Tune, and Master Tune settings.	p. 99, p. 100
Notes are broken off	Notes will be interrupted if more than 128 notes are sounded simultaneously.	Reduce the number of layers in the studio set you're using. Increase the voice reserve setting for layers in which notes must not drop out.	p. 44
Notes remain sounding when you play the keyboard	Could the polarity of the hold pedal be reversed?	Check the system setting Hold Pedal Polarity.	p. 98

Overview

Performing

Performance Functions

Editing

Sequencer (Creating Songs)

Sampler

Pads

DAW

Settings

Appendix

Troubleshooting

Problem	Items to check	Action	Page
Sound is still heard from the opposite side as well even when panned all the way to one side	Could effects be applied?	Since the FA's internal effects are stereo, applying an insert effect will allow effect sound to be heard from the opposite side even if the source sound is panned all the way to one side.	-
Notes played in a high register sound funny	When you play high notes on the FA, you might hear notes that fail to sound, whose pitch fails to rise, or a noise that changes depending on the note you play (a warbling, chirping, rustling, beeping, etc.)	This is usually because you have exceeded the highest note that the FA is able to produce, and won't occur with the notes you would normally use. This does not indicate a malfunction.	-
Can't play arpeggios	Could the part's Arpeggio Switch be "OFF"?	Turn the part's Arpeggio Switch "ON." If you're using multi part play mode, arpeggios cannot be played unless the part's Arpeggio SWITCH is "ON," even if the [ARPEGGIO] button is on.	p. 44
Pitch sometimes fails to rise when playing legato	When the Legato Switch is "ON" and Legato Retrigger is "OFF," and you hold down a low note and play a high note to produce a legato effect, the pitch might stop at a certain point and fail to rise as far as you expect because the upper limit of the wave data has been exceeded. If the tone uses multiple waves, and each of these waves has a different upper limit, the result might no longer sound mono.	If you want to make large changes in the pitch, you should turn Legato Retrigger "ON." For details on the parameters, refer to "Parameter Guide" (PDF).	-
When you press a pad, the sound plays and does not stop	Could the [HOLD] button be lit?	Press the [HOLD] button once again so the light goes out.	-
When you use Favorites to recall a sound, the sound is different than when you registered it	The registered content differs depending on the performance mode in which you registered the favorite.	Check the performance mode, and then re-register the favorite. If you registered the favorite in single play mode, only the tone settings are recalled. If you want studio set settings such as reverb to be recalled as well, select multi part play mode, save the studio set, and register it as a favorite.	p. 28
The keyboard won't play the sound of the pad part	Could you have changed the Rx Channel of the pad part?	Set the pad part number to match the Rx Channel number.	p. 44
Problems with the effects			
Effect not applied	Could the effect switch be off?	Check the on/off setting of each effect.	p. 52
	Check the send level to each effect.	The effect won't be obtained if the send level to that effect is set at 0. Even if the send levels to the effect is set above 0, the effect won't be applied if the multi-effect level, or reverb level are set to 0. Check each of these settings.	
You specified a delay time value (for example for multi-effect DELAY) as a note value, but there's a limit beyond which the delay time will not change	Check the delay time setting.	Since the delay time has an upper limit, specifying the delay time as a note value and then slowing down the tempo may reach this upper limit. The maximum delay time is the highest value that can be specified numerically (i.e., other than in terms of a note value).	p. 53
The Modulation or other controller is always on	Check the matrix control settings.	For PCM synth tones, you can use matrix control to control the tone in real time. Matrix control uses MIDI messages such as incoming MIDI control changes as a source to modify the parameters of a tone. Depending on these settings, the FA may respond to MIDI messages from an external MIDI device and be in an unexpected state.	p. 47
Problems with the sequencer			
An imported SMF file is not played correctly	Are Receive GM System On and Receive GM2 System On turned "ON"?	Turn Receive GM System On and Receive GM2 System On "ON."	p. 101
	Are you trying to start playback from midway through the song?	The beginning of a GM score song contains a GM/GM 2 system on message. In some cases, a GM score cannot be played back correctly unless this message is received	-
	Are you trying to play song data designed for the GS Format?	Data created exclusively for the Sound Canvas Series may not play back properly on the FA.	-
After recording, there is no sound when you play back the song	Could the tracks be muted?	Turn mute off.	p. 63
The tempo is different than the last time I played back the song.	Did you save the song?	On the FA, if you change the tempo and play back, that new tempo is not saved unless you save the song to user memory or an SD card. Conversely, if you save the song, the previous tempo disappears. Be careful to check the current tempo when you save the song.	p. 74
Sounds are switched without your intention	Could an unwanted program change have been input?	Delete the unwanted program change.	p. 69
	Could you have input a program change into the wrong track?	Check the MIDI channel.	p. 68
Data supposed to be present does not appear in microscope	In View Select, is any data set not to be displayed?	Change the View Select settings so that the data is displayed.	p. 69

Problem	Items to check	Action	Page
<p>After using a MIDI sequencer to play a song, sounds stopped playing</p> <p>No sound is played even when Program Changes are sent.</p>	Could the song data include Bank Select data that is not defined on the FA?	<p>It could be that a Bank Select in the song data that is not specified by the FA was encountered in the song. No sound is played if the tone group is not one designated by the FA with Bank Select MSB/LSB. Note that if you omit the Bank Select, and send only the Program Change, the tone in the currently selected group that has the specified Program Change number will play. Try resetting the tone using the panel controls. Furthermore, when selecting tones from an external MIDI device, be sure to send the Bank Select MSB/LSB and the Program Change as a single set for reliable reproduction. First sending the MSB and LSB (the order in which these are sent does not matter), followed by the Program Change.</p> <p>In some cases, you may be unable to hear any sound after playing the last song that was faded-out. This may be because the volume has been lowered by volume messages or expression messages. Check the value of these messages, and set them to appropriate values.</p>	p. 68
	Are more than 128 voices playing simultaneously?	Reduce the number of voices. With certain sounds like continuous sounds with long releases, even though the actual sound may not be audible to you, processing for playing the sound is still underway, so in these cases as well, the performance data can differ from the actual number of voices being played.	-
<p>Performances are sluggish, or have interruptions</p>	Are you using a tone that uses a lot of LFO?	Try changing to a different tone. LFO processing invariably places a big load on the machine, so heavy use of the LFO slows down processing for the FA overall, which can end up having affecting the expression of sounds themselves.	-
	Is the data concentrated at the beginning of the beats in the sequence data?	<p>Avoid overlapping data with the same timing by setting an offset of 1–2 tick instead. Data may easily become concentrated at the beginning of the beats in the song data when, for example, the song data is input using Step Recording, or if the data is quantized after being input with a keyboard in real time.</p> <p>Because of this, large amounts of data are sent to the FA, and the processing for expressing sounds becomes bogged down.</p>	p. 68
	Is there a Program Change at the point where the song performance is sluggish?	Change the position of the Program Change. When Program Changes are inserted in songs, processing time for switching tones increases, which may then cause the performance to become sluggish.	
	Is there a System Exclusive message at the point where the song performance is sluggish?	Move the location of the data. System Exclusive messages contain large amounts of data, thus placing a heavy burden on sequencers and sound modules. Try repositioning data and changing System Exclusive messages to Control Changes for any data for which Control Changes can be substituted.	
	Is there an Aftertouch or other such large Control Change at the point where the song performance is sluggish?	If the data is no longer needed, delete the data.	
Problems with saving			
<p>A studio set sounds different than when you saved it</p>	Save the tones.	If you edit the tones used by a studio set, or if the temporary tones of the studio set were rewritten from an external MIDI device, you'll need to save those tones as well.	p. 48
	Check the effect settings.	It may be that the total effect (tone effect) and master effect (system effect) settings were changed.	p. 52
Arpeggio and controller settings differ between studio sets	Check the arpeggio and controller settings.	Arpeggio and controller settings are independently saved for each studio set.	p. 33, p. 39
Problems with external MIDI devices			
No sound from an external MIDI device	Does the FA's MIDI transmit channel match the connected device's MIDI receive channel?	Match the FA's transmit channel and your connected device's receive channel.	p. 90
<p>Exclusive messages are not received</p>	Could Receive Exclusive be turned "OFF"?	Turn Receive Exclusive "ON."	p. 101
	Does the transmitting unit's Device ID number match the FA's Device ID number?	Set the Device ID numbers.	p. 101
When using DAW software, operating knobs or other controls does not affect the sound	Some DAW software may not "soft-thru" system exclusive messages.	If you're using this type of DAW software, and you want to record system exclusive messages, turn on the Local Switch.	p. 90
When the tone's bend range is large (48), the pitch does not rise to its full extent when a MIDI pitch bend message is received	Although a tone's bend range can be set in a range of 0–48, there are some waves for which the pitch cannot rise to the full extent of the pitch bend message, causing the pitch to stop rising at a certain point. We guarantee that the pitch will rise at least to a pitch bend range setting of 12, but please use caution if you specify a bend range that is greater than this.	-	-
Problems with the sampling			
The sound from an external input is not stereo (monaural)	Could the STEREO SW be set to "MONO"?	Set the STEREO SW to "STEREO."	p. 79

Overview

Performing

Performance Functions

Editing

Sequencer (Creating Songs)

Sampler

Pads

DAW

Settings

Appendix

Troubleshooting

Problem	Items to check	Action	Page
Sampled sound contains excessive noise or distortion	Is the input level appropriate?	If the input level is too high, the sound will distort. If the input level is too low, noise will be obtrusive. Adjust the input level to an appropriate setting.	p. 79
	Are the effect settings appropriate?	Some types of effect may increase the level louder than the original sample, or may intentionally distort the sound. Some effects will also cause noise to be emphasized. Temporarily turn off effects, and check whether the sample itself contains noise or distortion. Then adjust the effect settings appropriately.	-
	Are multiple samples being played simultaneously?	Even if the level of each individual sample is appropriate, simultaneously playing multiple samples may cause the overall level to be excessively high, causing distortion. Lower the level of each sample so that the sound is not distorted.	p. 81
Problems with a microphone or external device you're recording			
External input sound is not heard, or is too soft	Could the input volume be lowered?	When using the LINE jack: Adjust the volume on the connected device. When using the GUITAR/MIC jack: Adjust the rear panel [LEVEL] knob. If the volume is still insufficient, adjust the Audio Input Level.	p. 80
	Are the connection cables connected correctly?	Check the connections.	p. 8
	A connection cable may be broken.	-	-
	Could you be using a connection cable that contains a resistor?	Use a connection cable that does not contain a resistor.	-
Microphone sound is not heard, or is too soft	Are the microphone cable connected correctly?	Check the connection.	p. 8
	A microphone cable may be broken.	-	-
	Could the microphone volume be lowered?	Adjust the rear panel [LEVEL] knob. If the volume is still insufficient, adjust the Audio Input Level.	p. 80
	Could the [MIC/GUITAR] switch be set to "GUITAR"?	Set the [MIC/GUITAR] switch to "MIC"	p. 9
Problems with an SD card			
SD card is not recognized	Check the format of the SD card.		
Data on the SD card was damaged	Could a strong physical shock have been applied to the SD card?	Format the SD card on the FA.	p. 96
	Could the power have been turned off while accessing the SD card?		
	Could you have formatted the card on a computer or digital camera?		
Can't back up to SD card	Could the SD card be write protected?	Disable write protection.	p. 108
	Is there sufficient free space on the SD card?	Use an SD card that has sufficient free space.	-
	Check the format of the SD card. The FA can use SD cards that are formatted in FAT format.	Format the SD card on the FA.	p. 108
Problems with USB connection			
The FA is not detected by the computer	Does your computer's USB port support USB 2.0 Hi-Speed?	The USB port of the computer to which the FA is connected must support USB 2.0 Hi-Speed.	-

Problems when connecting to a wireless LAN

* For problems related to communication, refer also to the owner's manual of your wireless LAN access point.

* For details on operating your wireless LAN access point, refer to its owner's manual.

Problem	Cause/Action	Page
Cannot connect to wireless LAN	<ul style="list-style-type: none"> Check that your wireless LAN access point supports the WPS standard. If your wireless LAN access point does not support WPS, connect using the procedure described in "Connecting in Ad-Hoc mode (Ad-Hoc Mode)" (p.106). The FA does not support the 802.11a and 802.11b wireless standards. Please use 802.11g or 802.11n (both at 2.4 GHz). WEP authentication is not supported. Please use WPA or WPA2 authentication. Be sure that your wireless LAN access point is set to use DHCP. If the FA cannot connect to a wireless LAN access point that it previously could connect to, make sure the Ad-Hoc Mode setting is set to "OFF." You may not be able to connect to the wireless network depending on the condition of the wireless signal. In this case, refer to the procedure described in "Basic Connection Method (Connect by WPS)" (p.104) and try selecting and connecting to the wireless LAN access point again. The FA remembers a limited amount of information about network connections. Once the limit is reached, data from new connections may overwrite older data. All connection data will be erased if you perform a factory reset. If network connection information is erased, repeat the connection procedure and connect again. 	p. 104
"Access Point Not Supported" appears on the display and the FA cannot connect to the wireless LAN access point	The access point is not supported. Please use WPA or WPA2 authentication.	
Connection is unstable	<p>Wireless communications may be unstable if the condition of the wireless signal is poor. If the wireless communications are unstable, responsiveness may deteriorate and audio drop-outs may occur. The following may solve the trouble.</p> <ul style="list-style-type: none"> Move the FA and the wireless LAN access point closer to each other. Change the channel setting on the wireless LAN access point. 	
The FA does not appear among the instruments connected to your application	<ul style="list-style-type: none"> Is the FA turned on? Is a wireless USB adapter (WNA1100-RL) connected to the FA's USB MEMORY port? Is the FA connected to the wireless LAN? Are the FA and the iPad connected to the same network (i.e., the same wireless LAN access point)? Is the wireless LAN access point set to allow communication among the devices connected to it? Refer to the wireless LAN's documentation for information about the relevant settings. 	
The iPad cannot connect to the Internet	<ul style="list-style-type: none"> Is the wireless LAN access point connected to the Internet? Could you be connected in Ad-Hoc mode? <p>The iPad or other wireless device connected in Ad-Hoc mode will be unable to communicate with the Internet or with another wireless device. However, an iPad or other wireless device that has cellular capability will be able to connect to the Internet via the cellular connection. Please be aware that if you use a cellular connection for Internet connectivity, you may incur costs depending on your rate plan.</p>	

MIDI Implementation Chart

Sound generator section

Date : Jan. 1, 2014

Model FA-06/07/08

Version : 1.00

Function...		Transmitted	Recognized	Remarks
Basic Channel	Default Changed	1-16 1-16	1-16 1-16	
Mode	Default Message Altered	Mode 3 Mono, Poly *****	Mode 3 Mode 3, 4 (M=1)	*2
Note Number	: True Voice	0-127 *****	0-127 0-127	
Velocity	Note On Note Off	o o	o o	
After Touch	Key's Channel's	x o	o *1 o *1	
Pitch Bend		o	o *1	
Control Change	0, 32	o	o *1	Bank select
	1	o	o *1	Modulation
	2	o	o	Breath type
	4	o	o	Foot type
	5	o	o	Portamento time
	6, 38	o	o	Data entry
	7	o	o *1	Volume
	10	o	o *1	Panpot
	11	o	o *1	Expression
	16	o	o (Tone Modify 1)	General purpose controller 1
	17	o	o (Tone Modify 2)	General purpose controller 2
	18	o	o (Tone Modify 3)	General purpose controller 3
	19	o	o (Tone Modify 4)	General purpose controller 4
	64	o	o *1	Hold 1
	65	o	o	Portamento
	66	o	o	Sostenuto
	67	o	o	Soft
	68	o	o	Legato foot switch
	71	o	o	Resonance
	72	o	o	Release time
	73	o	o	Attack time
74	o	o	Cutoff	
75	o	o	Decay time	
76	o	o	Vibrato rate	
77	o	o	Vibrato depth	
78	o	o	Vibrato delay	
80	o	o (Tone Variation 1)	General purpose controller 5	
81	o	o (Tone Variation 2)	General purpose controller 6	
82	o	o (Tone Variation 3)	General purpose controller 7	
83	o	o (Tone Variation 4)	General purpose controller 8	
84	o	o	Portamento control	
91	o	o (Reverb)	General purpose effect 1	
93	o	o (Chorus)	General purpose effect 3	
1-31, 33-95	o	-	General purpose controller	
96, 97	x	x	Increment, Decrement	
98, 99	x	x	NRPN LSB, MSB	
100, 101	x	o	RPN LSB, MSB	
1-31, 33-127	o	-	DAW CONTROL	
Program Change	: True Number	o *1 *****	o *1 0-127	Program Number 1-128
System Exclusive		o *3	o *1	
System Common	: Song Position : Song Select : Tune	x x x	x x x	
System Realtime	: Clock : Commands	x x	o x	
Aux Messages	: All Sound Off : Reset All Controllers : Local On/Off : All Notes Off : Active Sensing : System Reset	x x x x o *1 x	o o x o (123-127) o x	
Notes		*1 O X is selectable. *2 Recognized as M=1 even if M≠1. *3 Transmitted only when "Transmitted Edit Data" is ON or RQ1 is received.		

Mode 1: Omni On, Poly
Mode 3: Omni Off, Poly

Mode 2: Omni On, Mono
Mode 4: Omni Off, Mono

o: Yes
x: No

Sequencer section

Date : Jan. 1, 2014

Version : 1.00

Model FA-06/07/08

Function...	Transmitted	Recognized	Remarks
Basic Channel Default Changed	All channel x	All channel 1-16	There is no specific basic channel
Mode Default Message Altered	x x *****	x x	
Note Number : True Voice	0-127 *****	0-127 0-127	
Velocity Note On Note Off	o o	o o	
After Touch Key's Channel's	o o	o *1 o *1	
Pitch Bend	o	o *1	
Control Change 0-119	o	o *1	
Program Change : True Number	o *****	o *1 0-127	
System Exclusive	o	o *1	
System Common : Song Position : Song Select : Tune	o *1 x x	o *1 x x	
System Realtime : Clock : Commands	o *1 o *1	o *1 o *1	
Aux Messages : All Sound Off : Reset All Controllers : Local Control On/Off : All Notes Off : Omni Mode Off : Omni Mode On : Mono Mode On : Poly Mode On : Active Sensing : System Reset	o o o *2 o *2 o o o o o o x	o *1 *3 o *1 x x *4 o *1 *3 o *1 *3 o *1 *3 o *1 *3 o o x	
Notes	*1 O X is selectable *2 Not recorded when received, but can be created and transmitted using Microscope *3 First, a a note-off message is recorded for each note that is currently on; then this message itself is recorded *4 The All Notes Off message itself is not recorded; a note-off message is recorded for each note that is currently on		

Mode 1: Omni On, Poly
Mode 3: Omni Off, Poly

Mode 2: Omni On, Mono
Mode 4: Omni Off, Mono

o: Yes
x: No



Main Specifications

Roland FA-06, FA-07, FA-08: Synthesizer Keyboard (Conforms to General MIDI 2 System)

Keyboard	
FA-06:	61 keys (with velocity)
FA-07:	76 keys (with velocity)
FA-08:	88 keys (Ivory Feel-G Keyboard with Escapement)
Sound Generator Section	
Maximum Polyphony	128 voices (varies according to the sound generator load)
Parts	16 parts
Tones	SuperNATURAL Acoustic SuperNATURAL Synth SuperNATURAL Drum Kit PCM Synth PCM Drum Kit * GM2 compatible sounds are included.
Wave Expansion Slots	2 slots * The wave expansion slots are rewritable internal waveform memory. You can download data from the Axial sound library site and write it via a USB flash drive into the FA's internal wave memory (slot).
Effects	Multi-Effects: 16 systems, 68 types (Vocoder can be used only on part 1.) Part EQ: 16 systems Drum Part COMP+EQ: 6 systems Chorus: 3 types Reverb: 6 types Master Compressor (This can be changed to Insert FX (78 types).) Master EQ Total Effects (TFX): 29 types Mic Input Reverb: 8 types
Sequencer	
MIDI Tracks	16
File format	Original, SMF export/import supported, WAV export supported * Sampler trigger data can be recorded.
Sampler	
Format	16-bit linear, 44.1 kHz, WAV/AIFF/MP3 import supported
Maximum Polyphony	8
Number of Samples	16 Pads x 4 Banks (for each song) * Samples cannot be used as wave data for the sound engine.
Other	
Functions	Favorite Rhythm Pattern Arpeggio Chord Memory
Controllers	D-BEAM Controller Pitch Bend/Modulation Lever Assignable Switch x 2 (S1/S2) Control Knob x 6 Sample Pad Tempo Knob
Display	5-inch Graphic Color LCD

External Memory	SD Card (SDHC supported)
Connectors	Headphones Jack: Stereo 1/4-inch phone type MAIN Output Jacks (L/MONO, R): 1/4-inch TRS phone type Sub Output Jack: Stereo 1/4-inch phone type AUDIO INPUT Jacks LINE: Stereo miniature phone type GUITAR/MIC: 1/4-inch phone type FOOT PEDAL Jacks (CTRL 1, CTRL 2, HOLD) MIDI Connectors (IN, OUT) USB FOR UPDATE Port USB COMPUTER Port (USB Hi-Speed AUDIO/MIDI) (Use a USB cable and a computer with a USB port that support USB 2.0 Hi-Speed.) DC IN Jack
Power Supply	
AC Adaptor	
Current draw	
1,300 mA	
Dimensions	
FA-06:	1,008 (W) x 300 (D) x 101 (H) mm 39-11/16 (W) x 11-13/16 (D) x 4 (H) inches
FA-07:	1,231 (W) x 311 (D) x 107 (H) mm 48-1/2 (W) x 12-1/4 (D) x 4-1/4 (H) inches
FA-08:	1,415 (W) x 340 (D) x 142 (H) mm 55-3/4 (W) x 13-7/16 (D) x 5-5/8 (H) inches
Weight (excluding AC Adaptor)	
FA-06:	5.7 kg 12 lbs 10 oz
FA-07:	8.5 kg 18 lbs 12 oz
FA-08:	16.5 kg 36 lbs 7 oz
Accessories	
Quick Start Leaflet "USING THE UNIT SAFELY" SD Card (installed in the product when shipped from the factory) SD Card Protector (installed in the product when shipped from the factory) AC Adaptor Power Cord	
Options (sold separately)	
Keyboard Stand (*1): FA-06, FA-07: KS-18Z, KS-12 FA-08: KS-G8B, KS-18Z, KS-12 Pedal Switch: DP series Expression Pedal: EV-5 USB Flash Memory (*2) Wireless USB Adapter: WNA1100-RL *1 When using the KS-18Z, ensure that the height of the unit is one meter or lower. *2 Use a commercially available USB flash drive or a USB flash drive sold by Roland. However, we cannot guarantee that all commercially available USB flash drives will work with this unit.	

* This document explains the specifications of the product at the time that the document was issued. For the latest information, refer to the Roland website.

MEMO

For details on how to place this unit on a stand, refer to **"Placing This Unit on a Stand"** (p.17).

Roland