

# soundhack TELHARMONIC



---

  
**tELHARMONIC**

FCC -----	3
Limited Warranty -----	4
Installation -----	5
Overview -----	6
Panel Controls -----	7
Composing 101-----	11
Sculpting Timbre -----	12
Color Staff -----	14
Composing Voltage Controlled Music Theory -----	15
3-Voice Shift Register -----	18
Patch Examples -----	19
Spiratone -----	25

---



This device complies with Part 15 of the FCC Rules. Operation is subject to the following two conditions: (1) this device may not cause harmful interference, and (2) this device must accept any interference received, including interference that may cause undesired operation.

Changes / modifications not approved by the Make Noise Co. could void the user's authority to operate the equipment.

This equipment has been tested and found to comply with the limits for a Class A digital device, pursuant to part 15 of the FCC Rules. These limits are designed to provide reasonable protection against harmful interference when the equipment is operated in a commercial environment. This equipment generates, uses, and can radiate radio frequency energy and, if not installed and used in accordance with the instruction manual, may cause harmful interference to radio communications.

Make Noise warrants this product to be free of defects in materials or construction for a period of one year from the date of purchase (proof of purchase/invoice required).

Malfunction resulting from wrong power supply voltages, backwards or reversed eurorack bus board cable connection, abuse of the product, removing knobs, changing face plates, or any other causes determined by Make Noise to be the fault of the user are not covered by this warranty, and normal service rates will apply.

During the warranty period, any defective products will be repaired or replaced, at the option of Make Noise, on a return-to-Make Noise basis with the customer paying the transit cost to Make Noise.

Make Noise implies and accepts no responsibility for harm to person or apparatus caused through operation of this product.

Please contact [technical@makenoisemusic.com](mailto:technical@makenoisemusic.com) with any questions, Return To Manufacturer Authorization, or any needs & comments.

<http://www.makenoisemusic.com>



THANK YOU:

DSP Wizard: Tom Erbe; **[www.soundhack.com](http://www.soundhack.com)**  
Beta Analysts: Devin Booze, Lee Coleman, Walker Farrell  
Test Subjects: James Cigler  
Spiritual Advisor: Richard Devine

### **About This Manual:**

Written by Tony Rolando and Walker Farrell  
Illustrated by W.Lee Coleman

---

**Electrocution hazard!**

Always turn the Eurorack case off and unplug the power cord before plugging or unplugging any Eurorack bus board connection cable.

**Do not touch any electrical terminals when attaching any Eurorack bus board cable.**

The Make Noise tELHARMONIC is an electronic music module requiring 139mA of +12VDC and 10mA of -12VDC regulated voltages and a properly formatted distribution receptacle to operate. It must be properly installed into a Eurorack format modular synthesizer system case.

Go to <http://www.makenoisemusic.com/> for examples of Eurorack Systems and Cases.

To install, find 14HP in your Eurorack synthesizer case, confirm proper installation of included eurorack busboard connector cable on backside of module (see picture below), plug the bus board connector cable into the Eurorack style bus board, minding the polarity so that the RED stripe on the cable is oriented to the NEGATIVE 12 Volt line on both the module and the bus board. On the Make Noise 6U or 3U Busboard, the negative 12 Volt line is indicated by the white stripe.

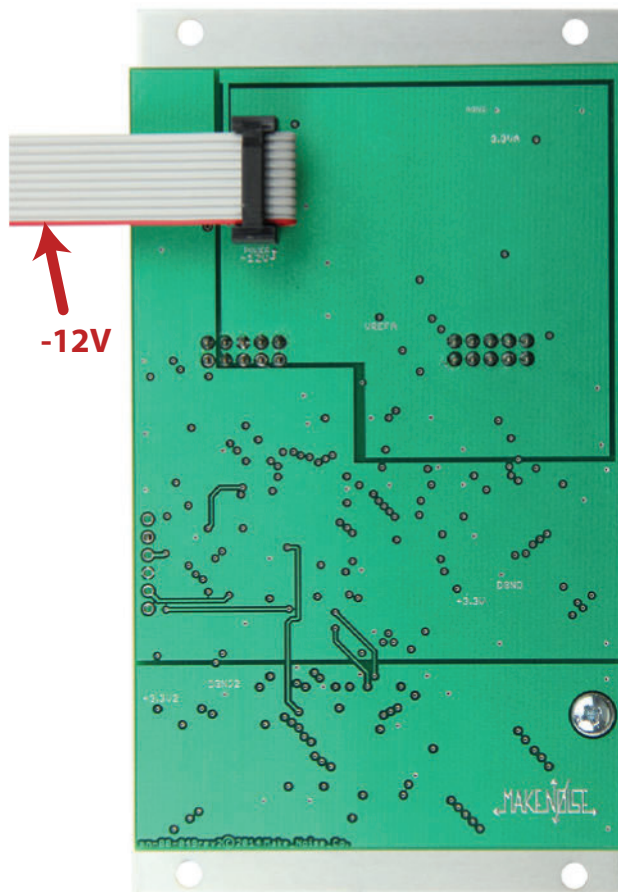

**Please refer to your case manufacturers' specifications for location of the negative supply.**

The tELHARMONIC is a Multi-Voice, Multi-Algorithm synthesizer module coded by Tom Erbe and named for the music hall where the first Telharmonium concerts were held. Telharmonic Hall is considered by some to be the location of the first electronic music concerts. The Telharmonium was an early, pioneering electronic musical instrument designed in 1897 by Thaddeus Cahill. It is believed to be first additive synthesizer.

The Telharmonium weighed 200 tons and occupied the entire floor of "Telharmonic Hall" on 39th Street and Broadway in New York City.

The Make Noise Soundhack tELHARMONIC module weighs less than 12 ounces and occupies 14hp in a Eurorack synthesizer system.

The goal with the tELHARMONIC was to present three historically important pioneering electronic music tone generation techniques less often implemented within the modular synthesizer: Additive Harmonic synthesis, inspired by Thaddeus Cahill's original Telharmonium; Noise synthesis, inspired by James Tenney's 1961, early computer music piece "Analog 1: Noise Study;" Phase Modulation synthesis, inspired by early commercial digital synthesis from the 1980's.

The tELHARMONIC could be thought of as having two sides. The left side has the voltage controlled music theory. Through the use of Tonic, Interval, Degree, and D-Gate, it is possible to create chord progressions, scales, and playing styles using control voltages rather than playing manually or programming with MIDI. These parameters influence the Noise, Harmonic, and Phase Mod Algorithms in a unified way. The right side of the tELHARMONIC has the controls for sculpting the timbre. These are the Centroid, Flux and H-Lock parameters. Each of these parameters controls the Timbre of each of the Algorithms in a different way. This allows for complex sounds to be created around a unified melodic structure and pattern. In other words, the Noise, Harmonic, and Phase Mod Algorithms, which are all available simultaneously at their respective outputs, were designed to be blended, mixed and used together to emphasize a single musical motif.

**To find the {Spiratone} within the tELHARMONIC:**

**With nothing patched to D-Gate,** [HOLD] H-LOCK for 5 seconds. The sound will dramatically change and you should now hear a Shepard Tone in the H or P Output(s). To return to tELHARMONIC, [HOLD] H-LOCK.

For more information, visit: <http://www.makenoisemusic.com/modules/Spiratone.html>

---

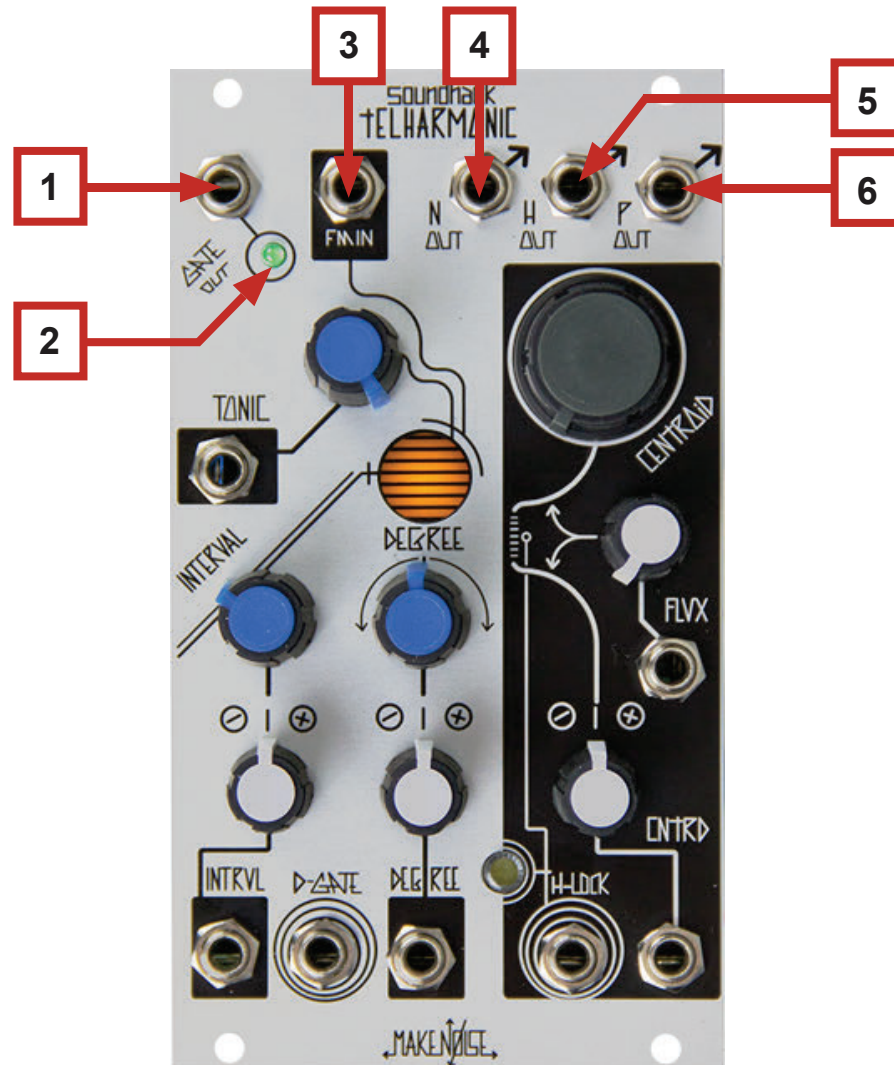

### tELHARMONIC Panel Controls

1. Gate Output: outputs Gate signal at each change in Degree. DC-coupled, 10V Gate.
2. Gate LED: visual indication of activity at Gate Output.
3. FM Input: input for Linear Frequency Modulation of the tELHARMONIC core. Modulates all 3 Algorithms (N, H, and P Outputs). AC-coupled; expects maximum signal level of 15Vpp.
4. N Output: output for the single-voice Noise Algorithm. Pitch set by Tonic and Degree and bandwidth set by Flux. Does not respond to Interval, Centroid, or H-Lock. AC-coupled, 8Vpp signal.
5. H Output: output for the three Voices of the Harmonic Algorithm. Core frequency is set by Tonic and Degree. The pitch spacing (harmonic relationship of the three voices to one another) is set by Interval and Degree. Timbre of this Output is controlled by Flux, Centroid, and H-Lock. AC-coupled, 10Vpp signal.
6. P Output: output for the three Voices of the Phase Mod Algorithm. Core frequency is set by Tonic and Degree. The pitch spacing (harmonic relationship of the three voices to one another) is set by Interval and Degree. Timbre of this Output is controlled by Flux and Centroid. Response to Flux is the inverse of that of the N and H Outputs. Does not respond to H-Lock. AC-coupled, 10Vpp signal.

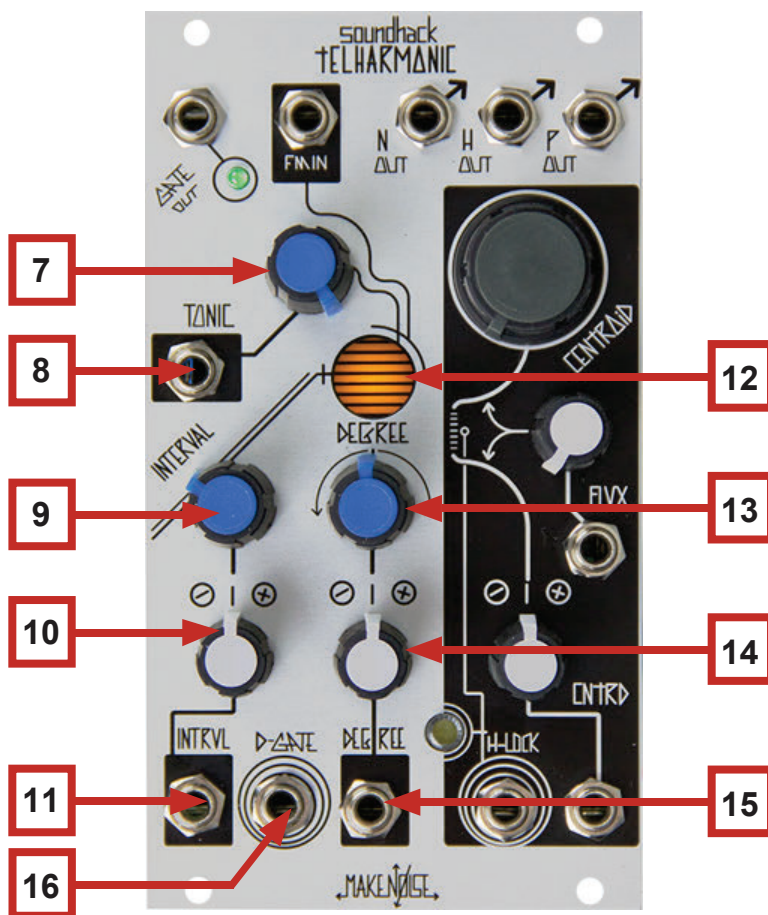

### tELHARMONIC Panel Controls (Cont'd)

7. Tonic Panel Control: adjusts the pitch of all Voices across 6 octaves.
8. Tonic CV Input: unity, 1V/Octave pitch control Input. Not quantized. Range 0V to 6V.
9. Interval Panel Control: sets the pitch spacing of the three Harmonic and Phase Mod Voices to form Triads (with two Inversions), Fifths, Unison, or Octave relationships. Continuously variable, aside from the two Inversions for Triads.
10. Interval CV Attenuator: bi-polar attenuator for Interval CV Input.
11. Interval CV Input: control signal Input for Interval. Range 0V to 5V.
12. Color Staff: Toward the center of the tELHARMONIC there is a visual indicator that changes color to display the state of Interval and Degree, while pulsing to show the frequency of the Tonic.
13. Degree Panel Control: quantized note selection, relative to the pitch as defined by Tonic. Also determines sonority of the Triad where applicable.
14. Degree CV Attenuator: bi-polar attenuator for Degree CV Input.
15. Degree CV Input control signal Input for Degree. Quantized parameter. Range +/- 2V.
16. D-Gate Input: Gate Input for activation of Degree parameter. Normalled High so that with nothing patched, Degree is always active. Requires a Clock/Gate signal of at least 5V and width of at least 10ms.



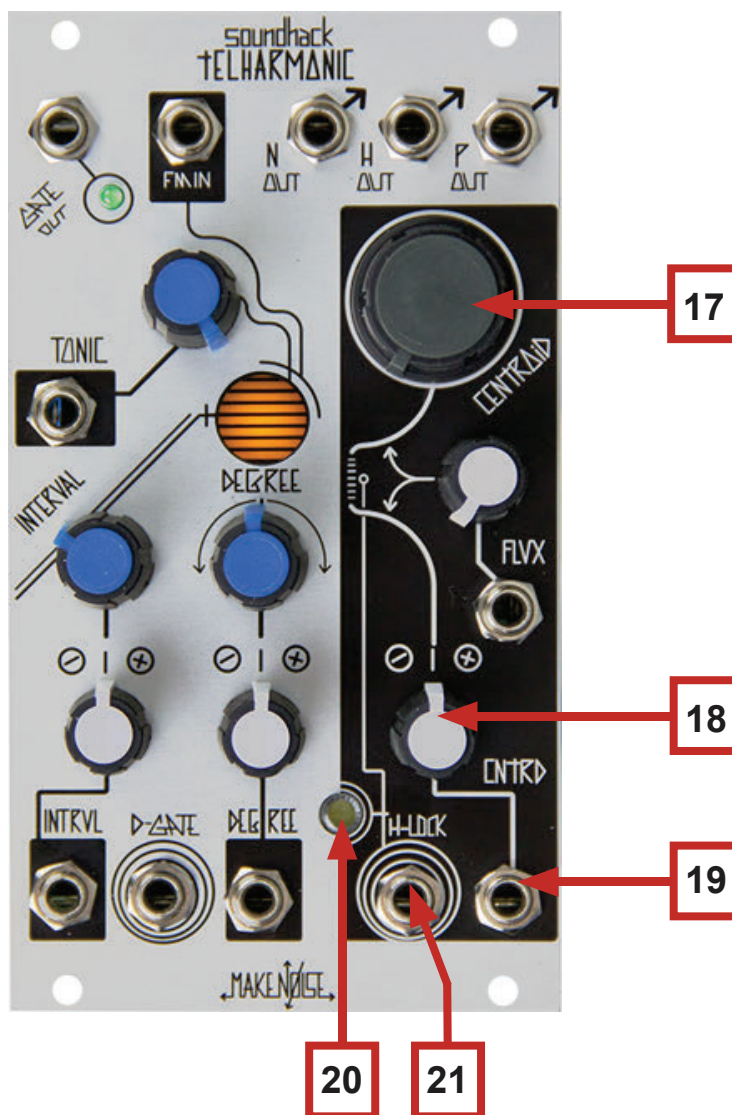

With nothing patched to D-GATE  
**TELHARMONIC Panel Controls (Cont'd)**

17. Centroid Panel Control: **Centroid has a different effect on the N, H, and P Outputs:**  
 H OUT: modulates or selects harmonics for emphasis by Flux and H-Lock parameters.  
 P OUT: sets the Phase Modulation Ratio.  
 N OUT: has no effect.
18. Centroid CV Attenuator: bi-polar attenuator for Centroid CV Input.
19. Centroid CV Input: control signal Input for Centroid. Range 0V to 8V.
20. H-Lock Button/LED: With Flux greater than 10%, sets the Harmonic selected by Centroid parameter to be locked ON. Multiple Harmonics may be locked ON. LED brightness indicates the number of Harmonics locked ON. To un-lock Harmonics, set Flux to 0% or [HOLD] the H-Lock Button for one second until the H-Lock LED fades Off. This parameter only affect the Harmonic Algorithm.

**With nothing patched to D-GATE:**

- [HOLD] for 5 seconds to find the {Spiratone}; [HOLD] to return.
- [HOLD] for 2 seconds to enter {Shift Register}; [HOLD] to return.

21. H-Lock Input: Gate Input for setting Harmonics to be locked On. Requires a Clock/Gate signal amplitude of at least 5V and a width of at least 10ms.

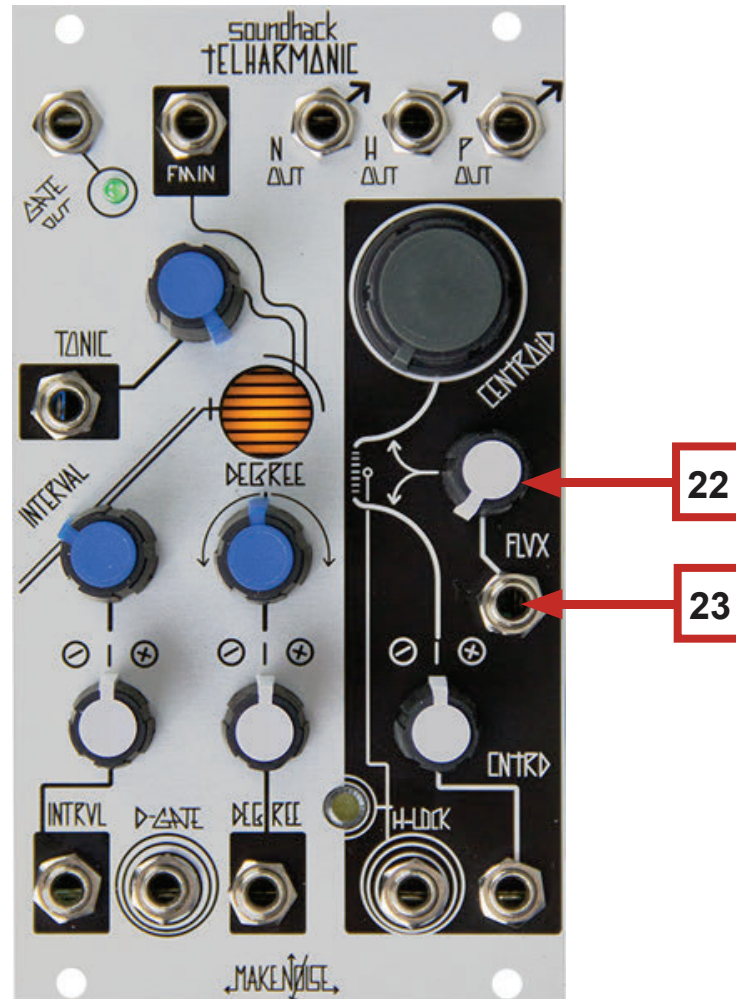

### TELHARMONIC Panel Controls (Cont'd)

22. Flux Combo Pot: unipolar Combo Knob. With nothing patched to Flux CV Input, functions as a standard panel control. When a control signal is patched to the Flux CV Input, functions as an attenuator for that signal as it is applied to the Flux parameter.

#### Flux has a different effect on the N, H, and P Outputs:

- N Output: increasing Flux focuses the noise around the Fundamental, as set by Tonic and Degree.
- H Output: At 0V (Flux Fully CCW), all Harmonics are equally emphasized. Increasing Flux de-emphasizes all Harmonics surrounding the Centroid, with the exception of those that are currently locked by H-Lock. This de-emphasis has the effect of emphasizing the Centroid.
- P Output: Flux sets the Index of Phase Modulation-- the ratio is set by Centroid. The response is the inverse to that of the H and N Outputs. At 0V (Flux Fully CCW), maximum Phase Modulation is achieved. Gradually increasing this parameter decreases the Index of the Phase Modulation.

23. Flux CV Input: unipolar control Input for Flux. Range 0V to +8V.

The left side of the module allows for patch programming chord progressions, scales, and melodies. It consists of the Tonic, Interval, Degree, and D-GATE parameters and the visual indication of the Color Staff. Although you will find great detail below about the inner workings in the next section, **NO KNOWLEDGE OF MUSIC THEORY IS REQUIRED TO COMPOSE WITH THE tELHARMONIC**. These parameters respond to control voltage just like anything else in your system.

Here are some quick pointers:

- You could think of Tonic as the main Pitch/Frequency control, similar to the grey knob on a DPO or STO. It is continuous (not Quantized) and responds 1V/Octave.
- Interval sets the spread of the Pitch/Frequency between voices in the H and P Outputs. There are three voices that can be set to Triad, Fifth, Unison, Octaves and anywhere in-between. Whatever Interval is selected will be maintained when Tonic is manipulated. Unison (about 3 o'clock) has all three voices set to the same note for behavior typical of a VCO.
- Degree adds or subtract up to two octaves from the base frequency set by Tonic. It has a Quantized response and also **tracks 1V/Octave when the Degree CV Attenuator is set Full CW**. Because Degree is a Quantized parameter, it has a "musically valid" response to any control voltage used.
- Whenever Degree changes values, a gate is generated and available for use at the Gate Output.
- The D-Gate Input operates as a Track & Hold for the Degree parameter. With nothing patched, D-Gate is held High and Degree always actively tracks the signal patched to the Degree CV Input. With a Clock, Gate, pulse, or trigger patched to D-Gate, the Degree parameter only tracks the signal patched to Degree CV Input while the D-Gate is held High.
- The FM Input is a fantastic way to introduce vibrato and pitch bend to a melody or progression. Patch any fast control voltage or expression voltage to the FM Input to experiment with this technique.

**For a more technical look at the musical applications of these parameters, read the section titled: "Composing with tELHARMONIC: Voltage-Controlled Music Theory."**

---

The tELHARMONIC has 3 independent and simultaneously available Algorithms, each with a unique timbre. Using two control voltages and a Gate signal, full timbral animation of the tELHARMONIC is possible. Because the Noise, Harmonic and Phase Mod algorithms all respond quite differently to these parameters, the results may be very complex, and it is also possible to have some voices deeply modulated while other voices are not modulated at all.

The single voice Noise Algorithm, N-OUT, is inspired by the Music III patch that composer James Tenney wrote at Bell Labs in 1961 for his first computer music piece, "Analog 1: Noise Study." It consists of two band-limited noise sidebands, which surround the frequency set by TONIC and Degree. Flux controls the width of the sidebands, which can go from extremely narrow (for a fluttering sinusoid) to full bandwidth. Using these two controls almost any color of noise may be generated.

For the Harmonic Algorithm, H-OUT, each of the three voices is a 24-partial harmonic oscillator, using high-resolution sine wave generators. The timbre is varied by the Centroid and Flux parameters, with Centroid setting the loudest of the 24 harmonics and Flux setting the steepness of the gain roll-off around that center harmonic. When Flux is full counter clockwise (no modulation), the spectrum is flat and sweeping the Centroid ripples the spectrum (like a string harmonic). When Flux is increased, the harmonics surrounding the Centroid decrease in amplitude and the sound becomes more focused upon the center harmonic, which causes modulation of the Centroid to have a more dramatic effect.

When Flux is not set to 0%, a Trigger or Gate in the H-Lock Input or a [PRESS] of the H-Lock button causes the partial that is currently selected by the Centroid parameter to be locked On at full amplitude even after Centroid changes. By sequencing Centroid and Locking harmonics, many additive timbres can be found. To clear all locked harmonics, [HOLD] the H-Lock button for 1 second or set Flux to 0% via panel control or CV. This parameter affects all three voices of the H-Output, but does not affect the P or N Outputs.

Each voice of the Phase-Modulation Algorithm uses 3, phase-locked, sine wave oscillators, arranged as 2 Modulators and 1 Carrier. This algorithm creates a large number of harmonically-locked partials by reshaping the Carrier (similar to wavefolding). The Centroid controls the frequency ratio of the modulation, and therefore, the brightness. The Flux controls the Depth of Modulation, which determines the number of partials. When Flux is full CCW, this is the largest number of partials; when full CW, there is only 1: a sine wave. The Centroid controls 2 adjacent harmonic modulation partials from 1 to 8. For example, when Centroid is at 2.5, the Modulator will be an even mix of harmonics 2 and 3.

---

**FM Input**

Another method of exerting external influence upon the tELHARMONIC, allowing for even more complex timbres by generating sidebands around all the harmonics created by each algorithm. Typically, an analog Sine or Triangle waveform from a VCO such as the STO or DPO would be patched to this input. The high harmonic content of the N, H, and P Outputs on the tELHARMONIC means many sidebands result from FM and so less complex waveforms such as Sine and Triangle yields the most controllable results. Additionally, an LPG or VCA such as the Optomix could be patched in series (between the STO and tELHARMONIC) to achieve a dynamic FM Index, also known as Dynamic Depth FM.

**Blending**

The Noise, Harmonic and Phase Mod voices were designed for fantastic spectral combination. The simplest way to do this is using a mixer. However, it is highly useful to have each output patched to its own VCA or LPG (such as the modDemix or Optomix) with a unique control signal to allow for the complete animation of dynamics and blending of the outputs.

**Harmonics and Temperment**

There are many settings of the right side of tELHARMONIC in which the upper harmonics dominate the spectrum. Meanwhile, the left side of the tELHARMONIC can be used to force the fundamental pitches of the three voices into Equal Temperament. These two planes of control create the possibility of using two tuning systems simultaneously within the same instrument. In other words, the tELHARMONIC provides the opportunity for smooth motion between Just and Equal Temperament.

Specifically, the TONIC, DEGREE and INTERVAL controls directly affect the fundamental frequency of the three voices of the P and H OUTputs.

TONIC and DEGREE track 1 Volt per octave in a way that befits their use in equal temperament music. But when DEGREE is set to a Triad, the three notes are distributed through the octave using meantone temperament, a pre-Baroque tuning system that produces thirds and fifths that are closer to "pure/just" than does the compromised tuning known as equal temperament. Another way to put it is that especially when used with harmonically rich sounds such as those produced by the tELHARMONIC algorithms, meantone temperament is less likely to produce audible dissonance than would equal temperament. A limitation of meantone temperament is that for any hard-tuned instrument such as organ, harpsichord or piano, it must be tuned to a particular key and any modulation/transposition away from that key will produce thirds and fifths that are less pure than those in equal temperament. These "wolf intervals" make playing most post-Renaissance Western music non-feasible on an acoustic meantone instrument. However, due to the digital nature of the tELHARMONIC, one can transpose the entire series of chords by sequencing the TONIC parameter, and thus maintain these pleasantly pure intervals no matter what key is being played.

The INTERVAL parameter, from 12:00 to full clockwise, sets the interval between two or all three voices as shown at the bottom of p.15. Notably, this control is fully continuous, meaning that any interval of any tuning system is possible between unity and fifth. Also, any doubled/stacked interval between unity and octave (examples include "whole note tone cluster", diminished triad, augmented triad, stacked fifths).

The CENTROID parameter of the H OUTput selects frequencies that are perfect harmonics of all three fundamentals. It is possible, depending on the setting of the FLUX parameter, to emphasize harmonics more heavily than fundamentals. In equal temperament tuning, harmonics of a single note are never exactly in tune with intervals between notes, because "ET" is a tuning that compromises "purity" in favor of flexibility.

Thus, it is possible to create many levels and shades of consonance and dissonance within the tELHARMONIC.

---

Toward the center of the tELHARMONIC there is a visual indicator that will change color to indicate the states of Interval and Degree while pulsing to indicate the frequency of the Tonic (often this frequency is high enough that the eye will not be able to discern). **Warning: Color Staff is for entertainment purposes only.**

**Second Inversion Triad:**

Major:  
(Aqua)



minor:  
(Baby Blue)



diminished:  
(Light Orange)



**First Inversion Triad:**

Major:  
(Turquoise)



minor:  
(Sky Blue)



diminished:  
(Orange)

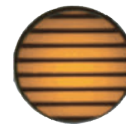

**Root Position Triad:**

Major:  
(Green)



minor:  
(Periwinkle)



diminished:  
(Dark Orange)

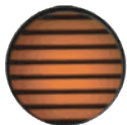

Fifth:  
(Peach)

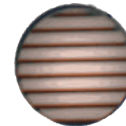

Unison:  
(Turquoise)



Octave:  
(Lavender)

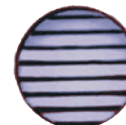

Recall from the previous section that the left side of the module allows for patch programming chord progressions, scales, and melodies. It consists of the Tonic, Interval, Degree, and D-GATE parameters and the visual indication of the Color Staff.

### Tonic

This parameter is similar to the Pitch control on a VCO, it responds continuously to a 1V/Octave signal across 6 octaves. Tonic controls all voices of the tELHARMONIC. This input is of course useful for patching typical modular sequencing techniques, micro-tunings, and modulations but it is also highly useful for transposing progressions and melodies that are patch programmed using the Degree parameter (see below). To achieve sequences or transpositions that are “in tune” you will either tune these Tonic changes by ear or utilize a Quantized CV source, such as the QCV output from René.

The Tonic parameter sets the base frequency for the Interval and Degree parameters. In other words, the Tonic sets the “key.” Here is how a portion of the Tonic control looks swept clockwise with Interval set to Root Triad and Degree set to a Major Triad. Note the Tonic control is continuous, thus the glissando markings. Also, note that the sonority of the triad (Major in this example) does not change as it moves:

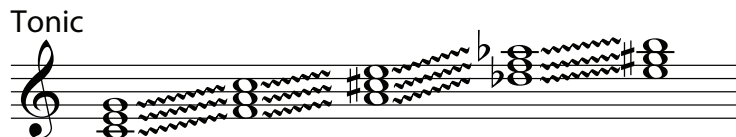

### DEGREE, D-GATE, AND GATE OUTPUT

These parameters do not compare to any of the inputs and outputs typically found on a VCO module. Degree is a quantized control that allows for ease in patch programming chord progressions and melodies using just about any control voltage. It makes note selection relative to the pitch set by Tonic and determines sonority of the Triad where applicable. Degree controls all Voices and algorithms of the tELHARMONIC and because it is a quantized parameter, any control voltage will result in a valid equal temperament progression.

When Interval is set to Unison, Fifth, Octave or any of their in-between spaces, Degree has twelve possible values per octave, corresponding to the chromatic scale. When Interval is set to Triad or a triad inversion, Degree has seven possible values per octave, corresponding to the degrees of the diatonic scale:

**I ii iii IV V vi vii°**

The pitch of “I”, and therefore the chosen “key,” is set by the Tonic parameter. Depending on the setting of the Degree panel control, diatonic chord progressions can be easily be programmed in any mode (including the Major and minor scales), with transposition/key change provided by Tonic.

Here is what a partial sweep of Degree looks like with Interval set to Root Position and Tonic set to D. Note that the resulting triads' sonorities always match their scale positions in the key of D Major/b minor:

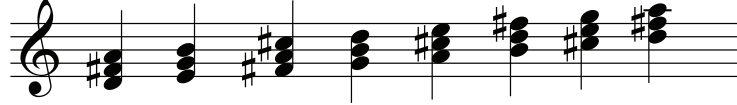
**Degree (Triads)**

When Interval is not set to Triad, Degree moves through the scale chromatically (12 possible values per octave rather than the 7 Triads). For example, here is part of a Degree sweep with Interval set to Fifth:

**Degree (Fifths)**

Using the D-Gate parameter, it is possible to limit the amount of change in the Degree which only changes when D-Gate is High (keep in mind that D-Gate is normalled to +5V so that with nothing patched to D-Gate, Degree is able to be changed). In this way, the D-Gate input allows the user to pick off notes and/or chords from a continuous (or non-continuous) control voltage. It is a way of extracting melodies and progressions from typically non-melodic sources such as LFOs, Envelopes, Expression Voltages, or Random Voltages. You could also use it to process Sequences where you do not want to utilize all notes in the Sequence or to limit Degree changes to a tempo or clock within the system. By varying the Width of the Gate signal patched to D-GATE to be narrow, you could grab single notes or chords from a control voltage. By setting the width of the Gate signal patched to the D-Gate to be wider, you could pick-off clusters of notes or chords from a control source.

With each change in Degree a gate signal is generated and output at the Gate Output. This gate is useful for triggering events to coincide with a change in the Chord or Note generated by the tELHARMONIC, for example an Envelope generator could be triggered to open a VCA or LPG each time the Degree is changed.

**Interval:**

This parameter controls the pitch spacing between the 3 Voices of the Harmonic and Phase Mod Outputs. The Noise Output is not controlled in any way by the Interval parameter because the Noise Output is a single voice.

The Interval parameter starts with the Triad sonority at Full CCW. The first triad structure is second inversion, followed by first inversion and finally root position. Note that for all three, the root is in the same octave, while the inversions move the third and/or fifth down an octave. After the three Triad types, interval begins to continuously detune and tune into Fifths followed by Unison and finally Octaves. There are many in-between tuning states allowing for programming of complex, even dissonant, chords. The continuous nature of the detuning and tuning makes Interval modulate smoothly. Here is what an F Major chord (as set by Degree and Tonic) looks like at all stages of the Interval parameter, starting from full Counterclockwise:

**Interval**



**Chord Progressions:**

With Interval set to Triad, Degree is the easiest parameter to sequence for traditional diatonic chord progressions in which the sonority of the chord changes according to its scale position. Because of this, the tELHARMONIC is quite a bit more versatile than past synth engines with "Chord modes." Clever sequencing of Degree, together with Tonic and Interval (especially if limiting the CV depth on Inter so that it only reaches the three Triad inversions) gives access to a great variety of possible chord progressions and key modulations.

In the past, the use of "chord machines" has typically involved selecting a chord structure such as "major" or "minor" and then moving the whole structure up and down when sequencing. Such blatantly-parallel movement would be anathema to the contrapuntal chorale writers of yore, but the sound of this type of chord progression is integral to many classics in the history of electronic music. To emulate this and sequence so-called "techno chords," simply pick a chord structure using Interval and Degree and then sequence only Tonic while leaving Degree static.

**Composition Tips and Tricks:****Triad Modes**

Set Interval to Triads (anywhere below 11:00). Use the Degree panel control to choose a mode. For Ionian (Major) and Aeolian (minor), use the RGB LED to find the starting point. Aeolian is a Blue or Periwinkle Triad that will be found one "click" to the left of the Orange Triad. Ionian is a Green/Aqua Triad that is found one "click" to the right of the Orange Triad. Now, patch a sequence from BRAINS, René, or Wogglebug to Degree to sequence chords in your chosen mode.

Starting from the Green Triad (one click to the right of Orange), here are the seven available modes:

**Ionian (Green)**  
**Dorian (Blue)**  
**Phrygian (Blue)**  
**Lydian (Green)**  
**Mixolydian (Green)**  
**Aeolian (Blue)**  
**Locrian (Orange)**

**Sequencing with Accidentals:**

Choose a mode as described in "Triad Modes." Sequence a chord progression of your choice. Use the unquantized CV output of René, or another row of Pressure Points Tuned Voltages, to modulate Interval to Unison or Octaves on steps where you would like accidentals to be possible. For these steps, adjust the sequence values for Degree so that the desired accidental is produced.

**Vibrato via FM Input:**

In addition to the timbral sculpting possible with this input (detailed in the "Sculpting Timbre with tELHARMONIC" section) the FM Input is also a fantastic way to introduce vibrato or pitch bend to a melody or progression. Patch any fast control voltage or expression voltage to the FM Input to experiment with this technique. Even a Gate signal could be attenuated and applied to this input to achieve sequenced pitch bends.

---

The tELHARMONIC Voltage Controlled Music Theory has an alternate behavior: a 3-Voice {Shift Register} that allows for the creation of any 3-note chord within the twelve-tone scale, spanning up to four octaves.

In order to access {Shift Register}, with nothing patched to D-Gate, [HOLD] the H-Lock button for 2 seconds and watch for the Color Staff to become solid while listening for a single, solid tone. This indicates {Shift Register} is Active. To deactivate {Shift Register}, [HOLD] H-Lock to return.

**{Shift Register} changes the behavior of the Degree, D-Gate, and Interval controls.**

Each time the D-Gate Input sees a Pulse, Gate, Clock, or Trigger, Degree updates the pitch of one of the three voices present in the Harmonic and Phase Mod algorithms. (Since the Noise algorithm is a single voice, its operation remains unchanged.) Each successive Pulse, Gate, Clock, or Trigger at the D-Gate Input causes the next voice to update its pitch based on the Degree setting.

**Degree** does not change without first patching something into D-Gate. Also, since D-Gate only sees “rising edges,” normalization has no effect. In order to achieve Degree modulation, you must first patch a signal, for example, a pulse stream to D-Gate.

**Interval** determines which notes may be accessed by the Degree parameter. Starting from fully counterclockwise, the possible settings are:

**Suspended chord (1,4,5)**  
**minor triad**  
**Major triad**  
**Octaves + fifths**  
**Chromatic**  
**Octaves only**

**Note: {Shift Register} DOES NOT change the behavior(s) of Centroid, Flux, and H-Lock.**

**Creating Chords:**

With Interval set to Chromatic, any 3-note chord can be created with a spread of up to four octaves. With a programmable Quantizer, such as the one found in René, it is possible to sequence chords, arpeggios, and melodies in any key or scale.

A CV keyboard, such as the KMI QuNexus, provides the most flexibility in chord selection. To accomplish this, send the keyboard’s Gate Output to D-Gate and the keyboard’s CV to the Degree Input. Now, you can play whatever chord you’d like by manually selecting three notes in succession! This also works nicely for chord changes layered within a simple sequence patched to TONIC.

---

## Drone with Sequential Harmonics (Thanks, Tony):

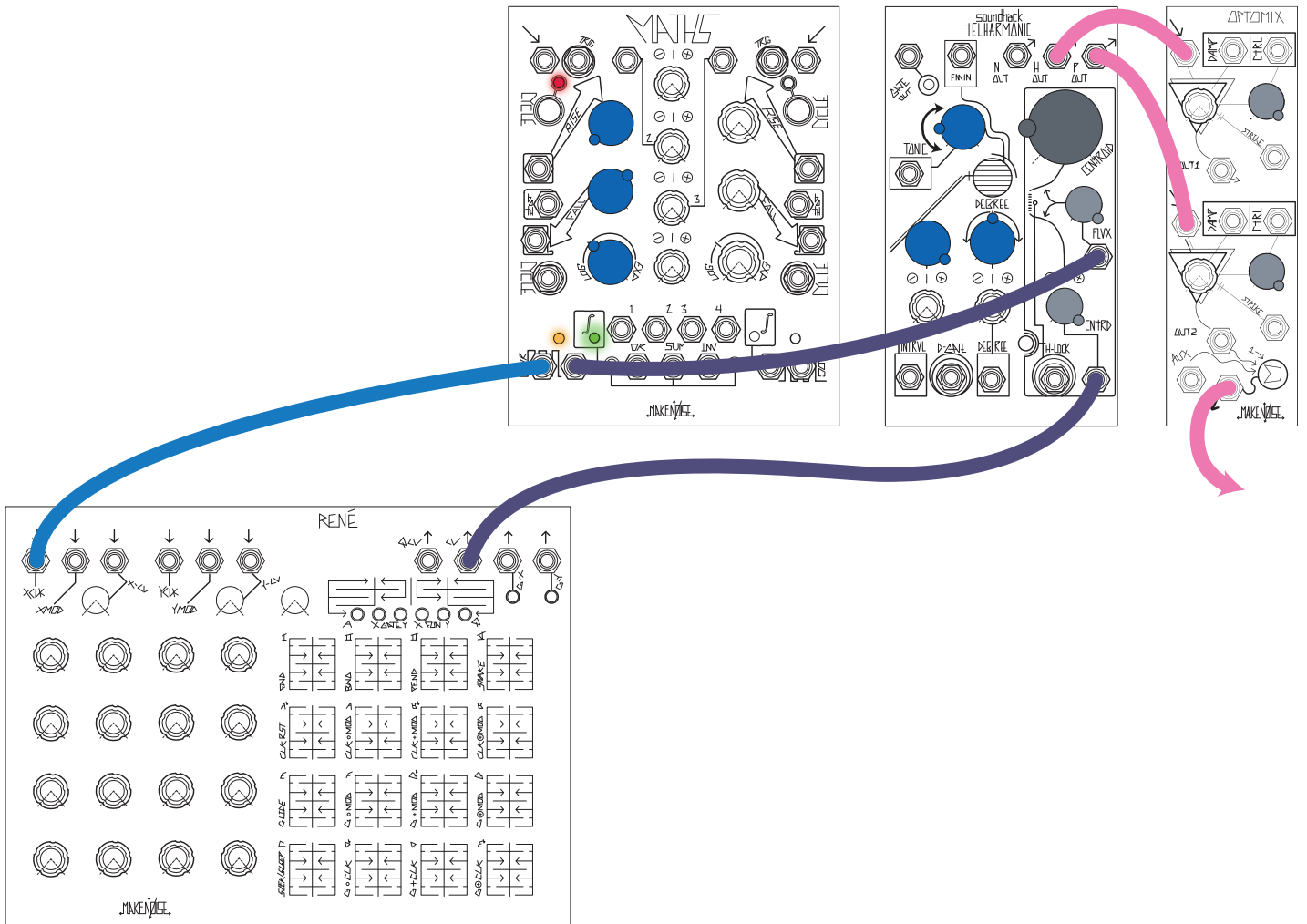

## Variation:

1. Patch tELHARMONIC N Output to FM Input.
2. With René CV Output still patched to tELHARMONIC Centroid CV Input, patch René QCV Output to an analog VCO's, (such as STO or DPO) 1V/Octave Input and tune the STO or DPO to one octave below the TONIC of tELHARMONIC. Set René Q Page for Octaves only. Blend the analog VCO with H and P OUTS using OPTOMIX's AUX Input, mixing the tELHARMONIC's H and P OUTs using the Ch.1 and Ch.2 Control knobs.

## Patch Example: Additive Presets (Thanks, Walker Farrell):

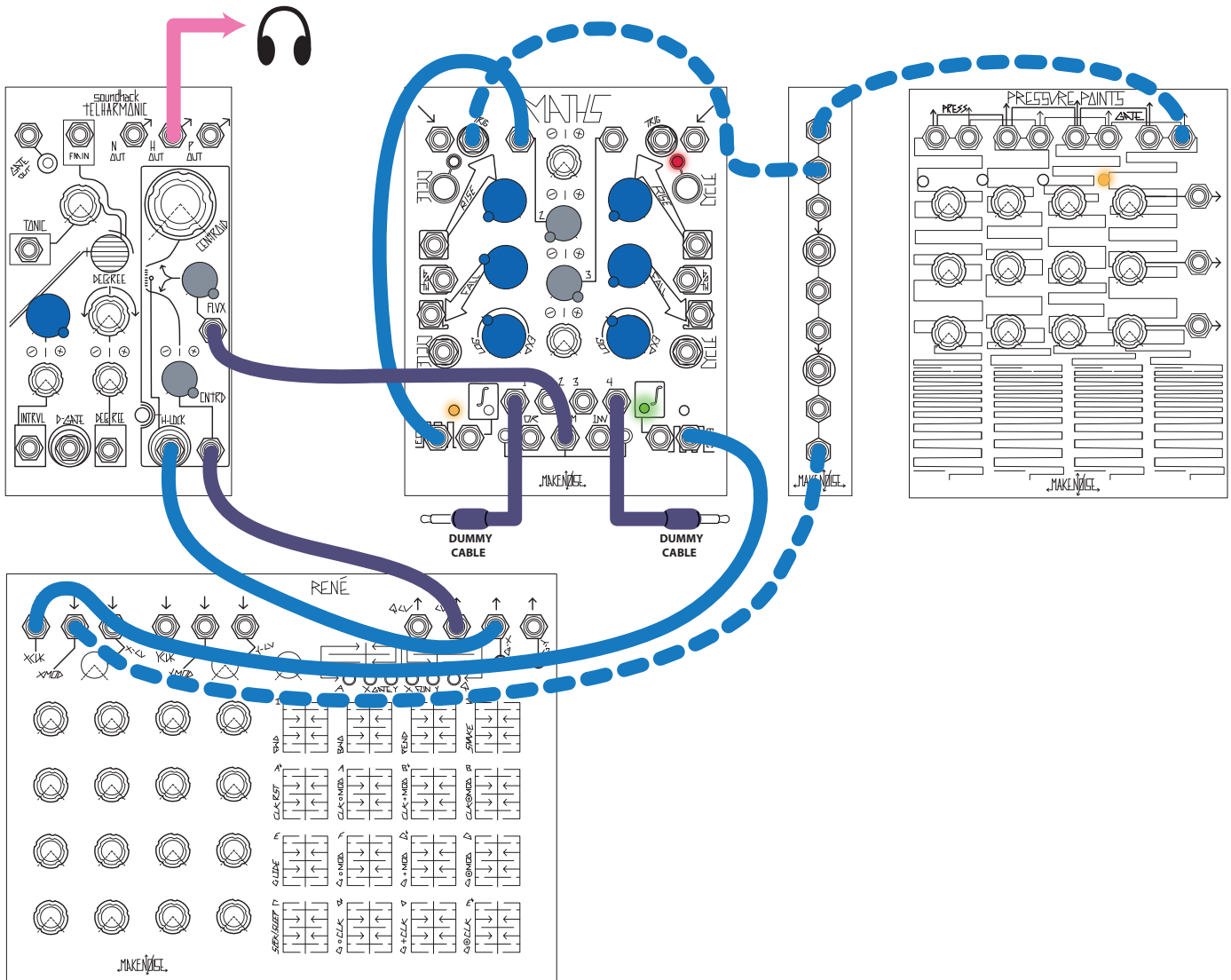

-Set Tonic and Degree to taste.

-Set René to Cartesian Mode on X-FUN page, and engage "Clock AND Mod.

Press the Pressure Points touchplate to "write in" the four harmonics of the selected René row. Each new press will clear the locked Harmonics and write the new ones.

### Variation:

1. Use a slow clock instead of Pressure Points gate, and Mult it to Y-CLK input. A new set of Harmonics is introduced at each clock pulse.

## Interstellar Drone (Thanks, Tony):

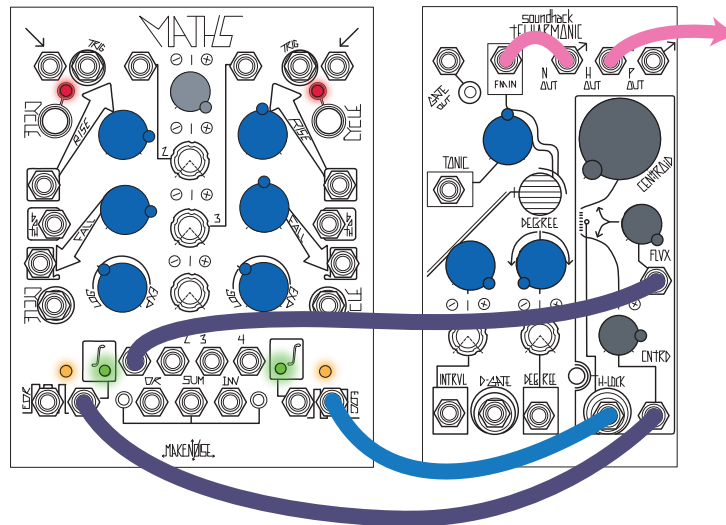
**Variations:**

1. Patch a sequencer to tELHARMONIC Degree Input.
2. Set Centroid Panel Control full clockwise and Centroid CV Attenuvertor full counterclockwise.

## Ascending / Descending Run (Thanks, Tony):

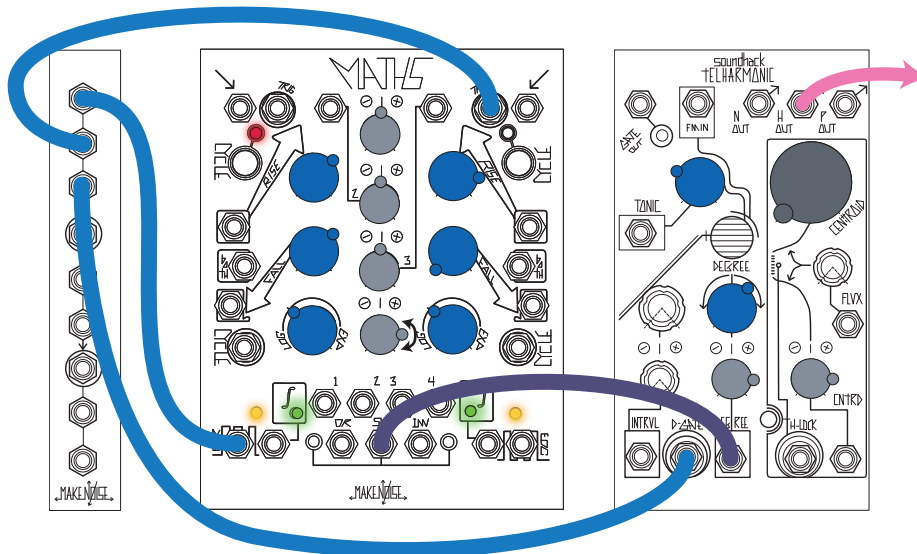

If patched correctly, you should hear an Ascending Run. Setting the Degree Attenuverter to 10:00 and Degree Panel Control to 3 o'clock should produce a Descending Run.

**Variations:**

1. Set MATHS CH. 1 Attenuvertor to 1:00 for alternating run.
2. Patch a sequence that is synchronized to MATHS EOR to tELHARMONIC Tonic Input. Sequences running at a multiple of MATHS CH. 1 will yield particularly interesting results.
3. Patch the tELHARMONIC H-Output to Optomix Ch.1 Signal Input. Patch tELHARMONIC Gate Output to Optomix Strike Input or to trigger an envelope to patch to Optomix Ch.1 Control Input.

**Intelligent Bass (Thanks, Tony):**

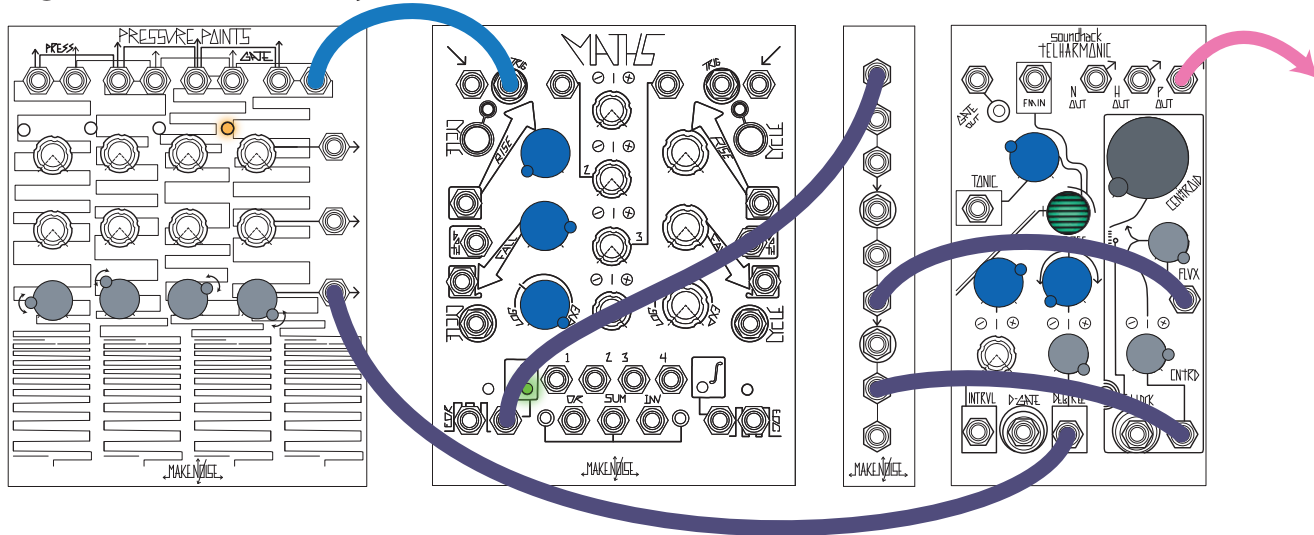

**Variation:**

Instead of using the Pressure Points Tuned Voltage Output, use a Keyboard or Sequencer's CV Output to control Degree. Patch the Keyboard/Sequencer Gate Output to MATHS (or FUNCTION) Trigger Input.

**Solar Wind Chimes (Thanks, Walker Farrell):**

[Click here to watch on YouTube](#)

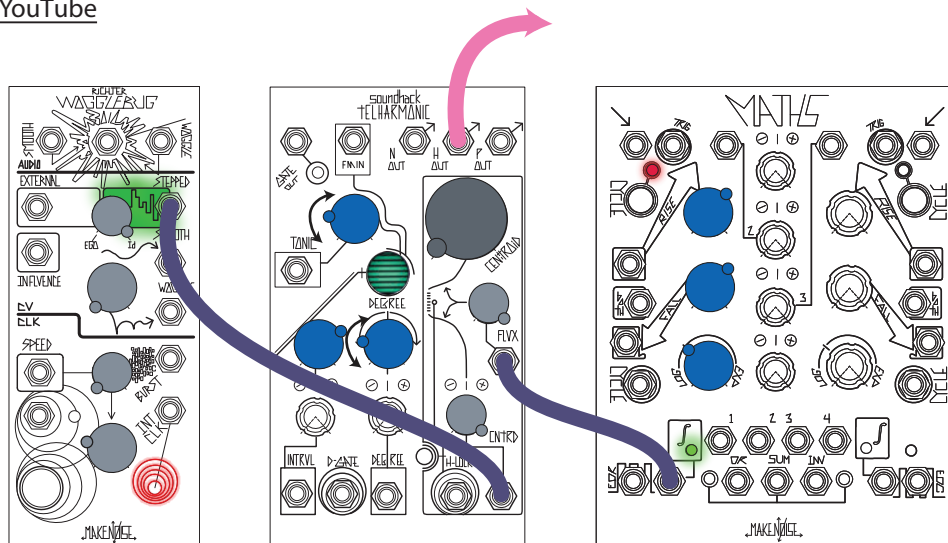

Set Interval to Unison (~3:00, Turquoise Color Staff), add adjust Tonic and Degree to set desired fundamental. With each cycle of MATHS, several random Harmonics are locked, which are cleared at the end of the cycle.

**Variations:**

1. **This variation adds the whooshing of wind to the ringing of the chimes:** Patch H Out to Optomix Ch.1 Signal Input. Patch N Out to Optomix Ch.2 Signal Input. Mult MATHS Unity to Optomix Ch2 Control CV In. Set Control knobs to taste, while monitoring from the Optomix's SUM Output.

2. **This variation adds semi-predictability to the chime pattern:** Doublecheck that the Wogglebug clock rate is somewhat higher than the MATHS cycle rate (at least 4 WB clocks per MATHS cycle). Mult MATHS Unity to Wogglebug external Input, adjust Ego/Id Balance full CCW, gradually increasing to taste.

**Chordal Accompaniment Variations (Thanks, Walker Farrell):**

[Click here to watch on YouTube](#)

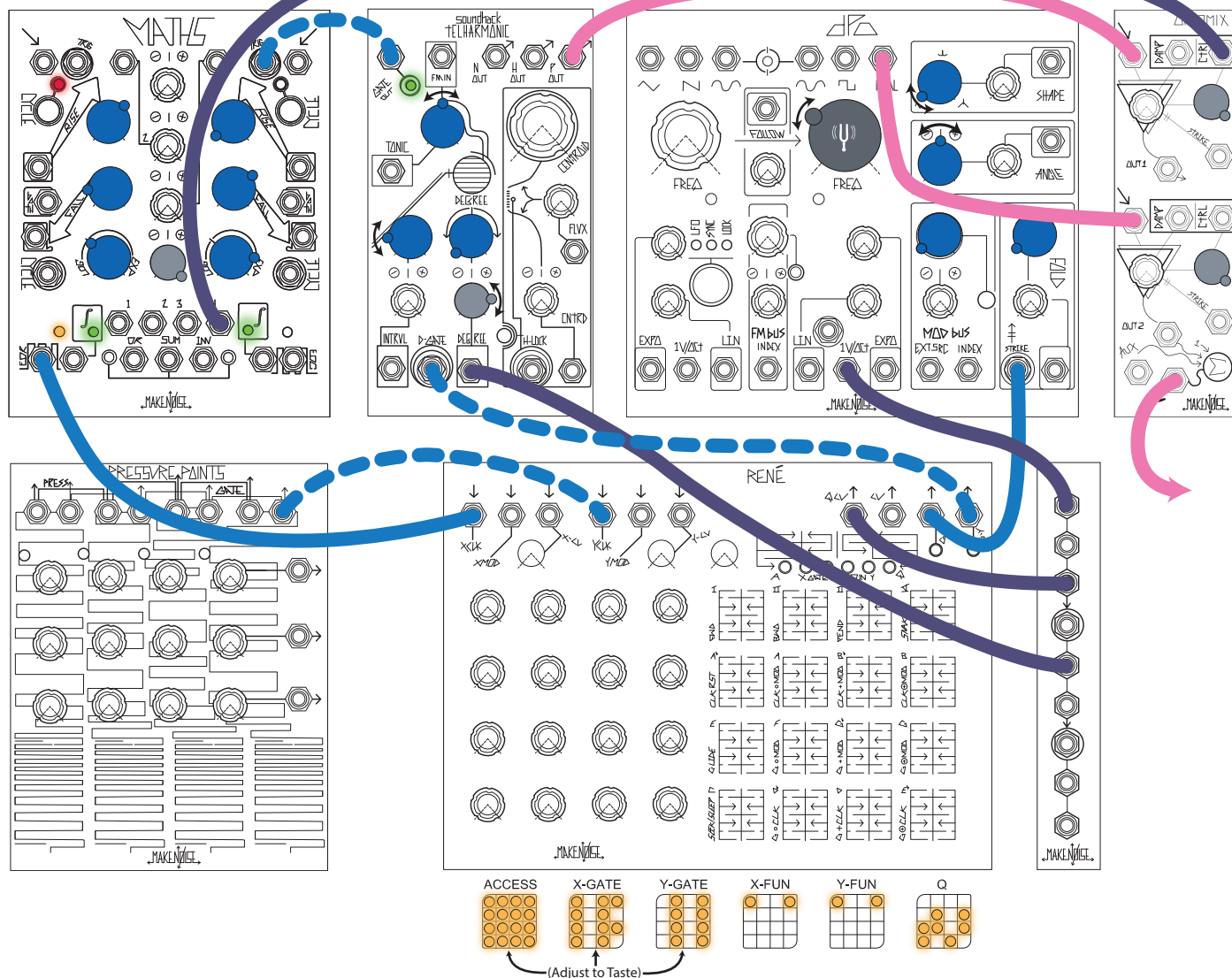

Adjust the tELHARMONIC's Tonic Panel Control until it sounds in tune with the DPO's VCO B Frequency. Set the Degree Panel Control full CCW, Interval to a Triad. Adjust the DPO's Fold Panel Control full CCW with the Shape and Angle Controls to taste. Set the Degree input attenuator to taste. Adjust or modulate Centroid, Flux and/or H-Lock to taste.

Each press of the Pressure Points selects a new chord progression. Sparser Y-Gate settings yield sparser accompaniment.

**Variation:**

1. Run QCV through a VCA prior to Degree to place chord progression range under voltage control (should still mult the unaltered QCV to DPO). For example, set Degree Panel Control to 12:00, and patch QCV to the modDemix Channel 1 Input, modulated with a bipolar control signal. Patch Ch.1 Output to Degree.
2. For different chord lengths, use Rene CV Output to modulate MATHS Fall time.
3. Patch a slower clock instead of the Pressure Points Gate Output in order to change patterns automatically.

**Broken and Fixed Arpeggios (Thanks, Walker Farrell):**

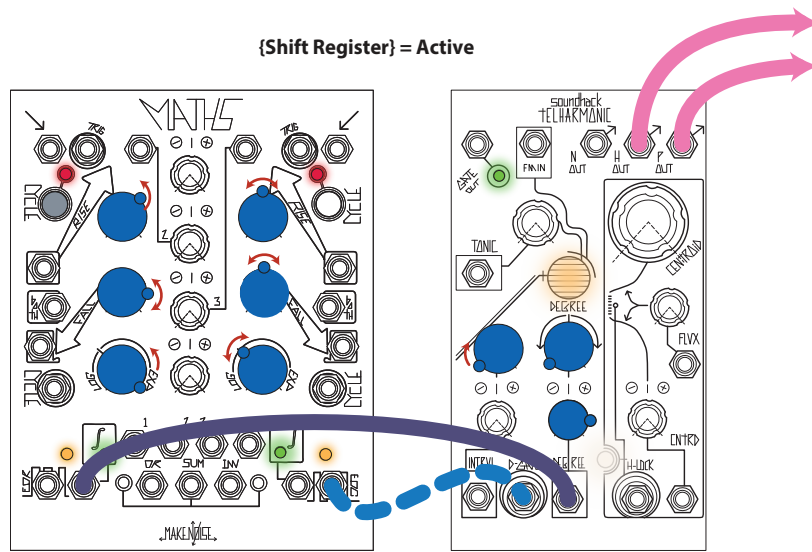

**Variation:**

Sequence Tonic and Interval to achieve chord progressions.

**Clusters and Frames (Thanks, Walker Farrell):**

Create any 3-voice pattern in any scale by altering the Snake pattern, Location panel controls, and {Q} Page settings.

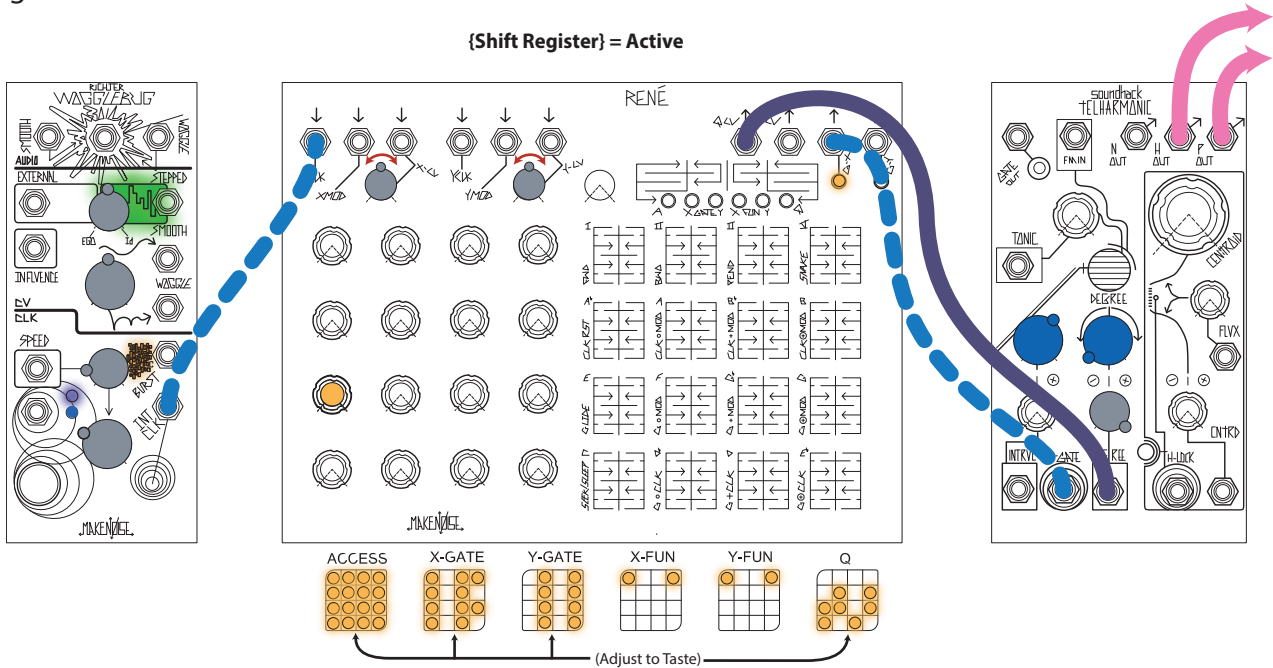

**Variation:**

Sequence Centroid with René's unquantized CV Output and H-Lock with G-Y, while also shifting Snake patterns (don't forget to clear H-Lock periodically-- either manually or by bringing Flux Full CCW with CV).



# soundhack SPIRATONE



The {Spiratone} is a type of Shepard Tone generator. It is a sonic barber pole that creates the auditory illusion of a tone that continually ascends or descends in pitch, yet ultimately seems to get no higher or lower. It was inspired by Jean-Claude Risset's "Computer Suite from Little Boy: Fall," 1968 and James Tenney's "For Ann (rising)," 1969.

It occupies the same space as the tELHARMONIC.

**To find the {Spiratone} on the tELHARMONIC:**

**With nothing patched to D-Gate,** [HOLD] H-LOCK for 5 seconds. The sound will dramatically change and you should now hear a Shepard Tone in the H or P Output(s).

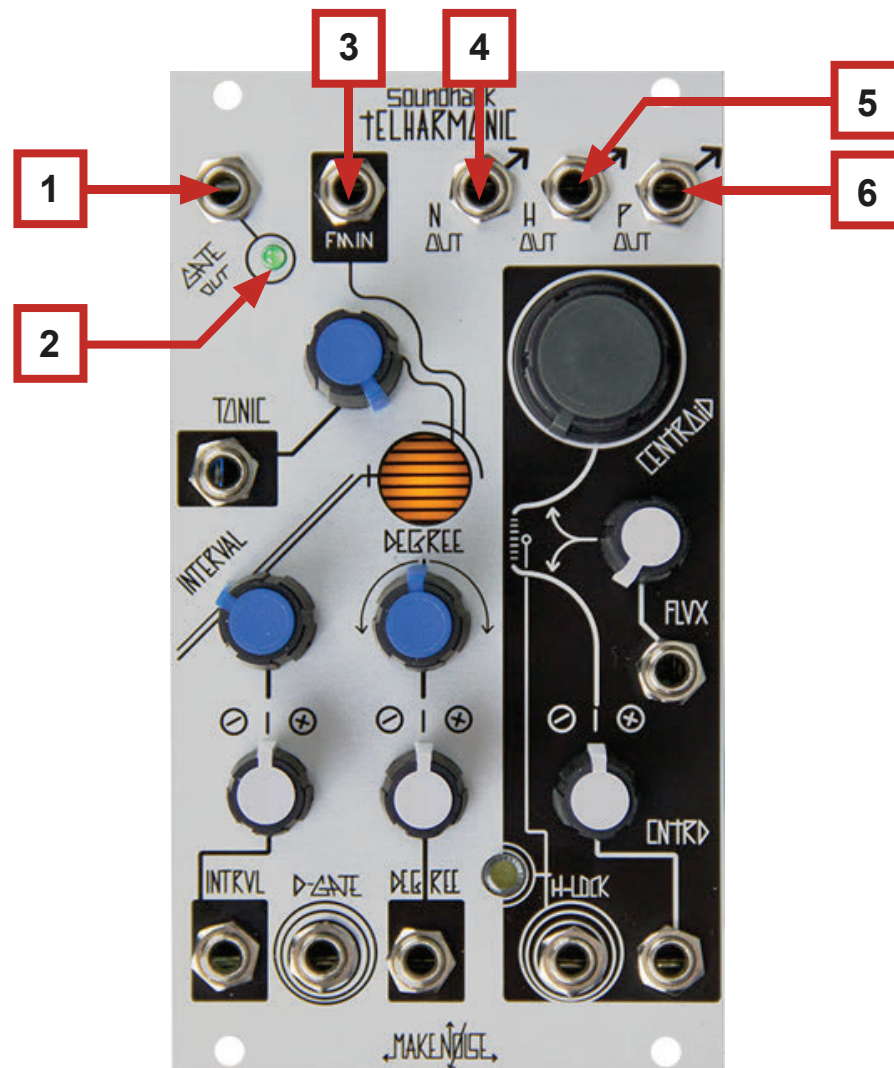

### {Spiratone} Panel Controls

1. Gate Output: outputs Gate signal at each change in Degree. 0-10V Gate.
2. Gate LED: visual indication of activity at Gate Output.
3. FM Input: NOT UTILIZED
4. N Output: output for the single-voice Noise Algorithm.
5. H Output: Output for half of the Spiratone's oscillators. 10Vpp signal.
6. P Output: Output for the other half of the Spiratone's oscillators. 10Vpp signal.

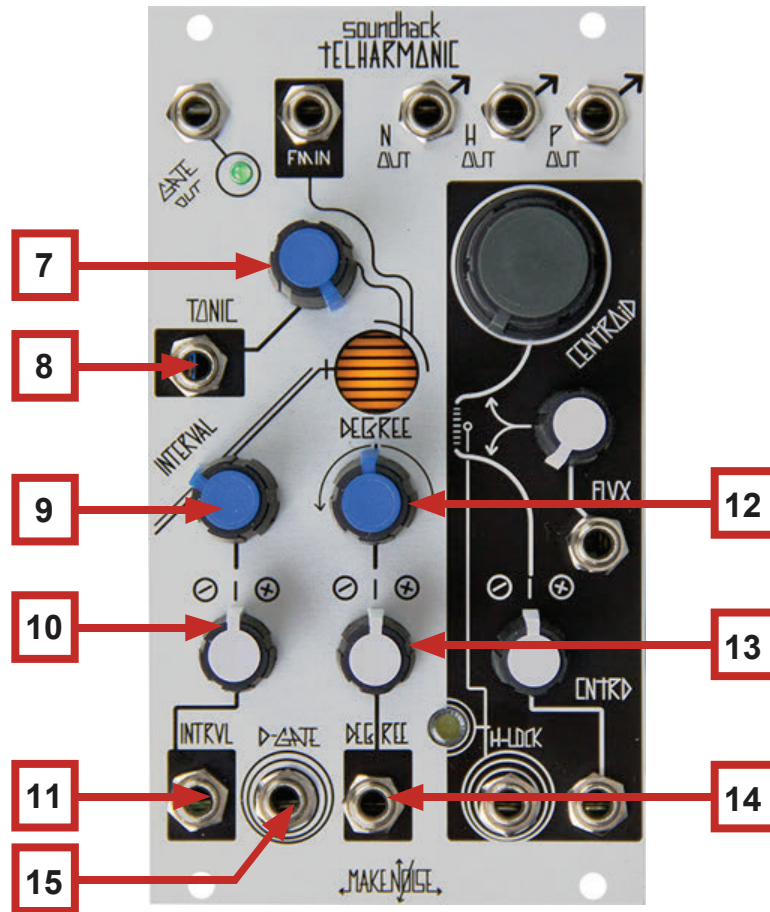

### {Spiratone} Panel Controls (Cont'd)

7. Tonic Panel Control: adjusts the pitch of all oscillators.
8. Tonic CV Input: unity, 1V/Octave pitch control Input. Not quantized. Range 0V to 6V.
9. Interval Panel Control: Sets internal modulation speed, no modulation at 12:00, modulates clockwise from 12:00, and down counterclockwise from 12:00.
10. Interval CV Attenuator: bi-polar attenuverter for Interval CV Input.
11. Interval CV Input: control signal Input for Interval. Range 0V to 5V.
12. Degree Panel Control: quantized note selection, relative to the pitch as defined by Tonic. Also determines sonority of the Triad where applicable.
13. Degree CV Attenuator: bi-polar attenuverter for Degree CV Input.
14. Degree CV Input: control signal Input for Degree. Quantized parameter. Range +/- 2V, with Panel Control at 12:00.
15. D-Gate Input: Gate Input for activation of Degree parameter. Normalled High so that with nothing patched, Degree is always active. Requires a Clock/Gate signal of at least 5V and width of at least 10ms.

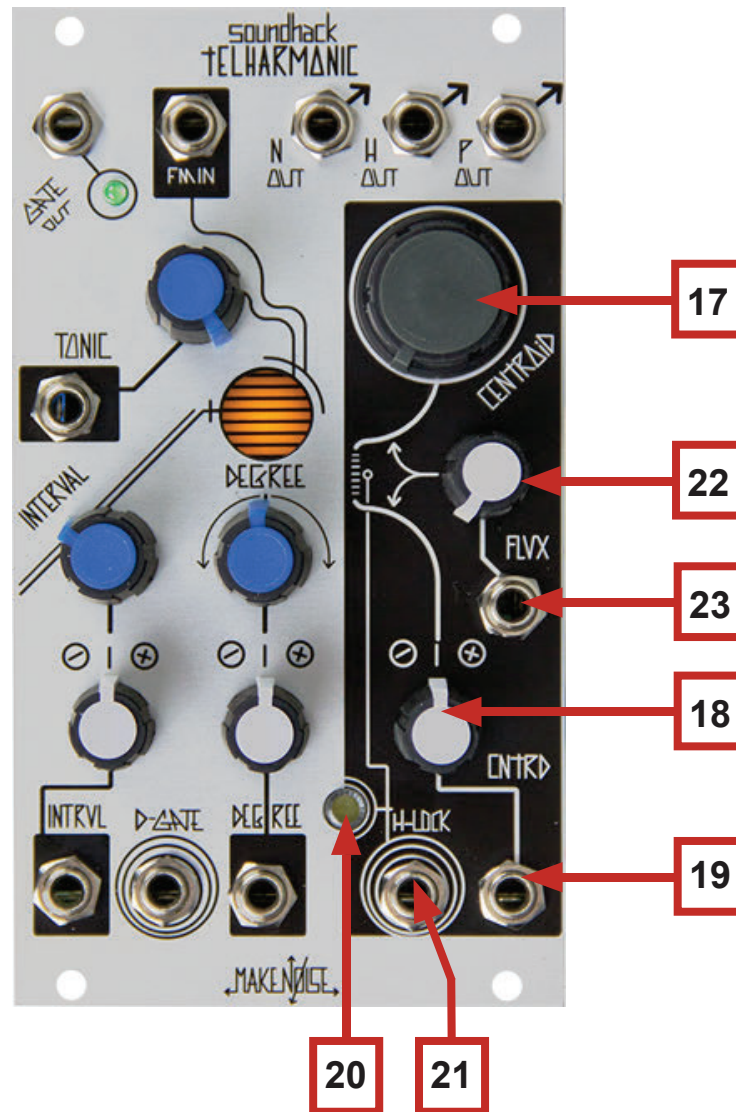

### {Spiratone} Panel Controls (Cont'd)

- 17. Centroid Panel Control: Sets the spacing of the oscillators from one octave to a very narrow pitch difference.
- 18. Centroid CV Attenuverter: bi-polar attenuverter for Centroid CV Input.
- 19. Centroid CV Input: control signal Input for Centroid. Range 0V to 8V.
- 20. H-Lock Button/ LED: [HOLD] to exit {Spiratone} and return to {tELHARMONIC}.
- 21. H-Lock Input: Not used
- 22. Flux: Sets the level of Random Pitch Modulation
- 23. Flux CV Input: unipolar control Input for Flux. Range 0V to +8V.

### Patch Example: Sentient Bottle Rocket (Thanks, Tony!):

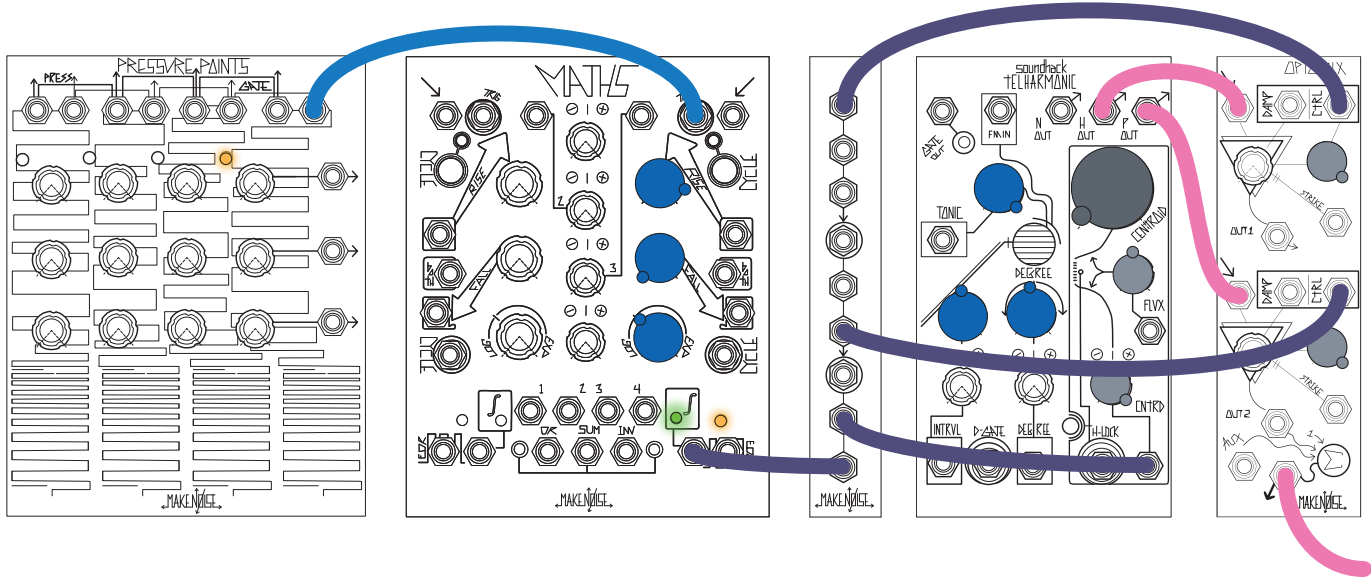

Press any pad on the Pressure Points to ignite the Sentient Bottle Rocket.

### Patch Example: Artificial De-Celeration (Thanks, Tony!):

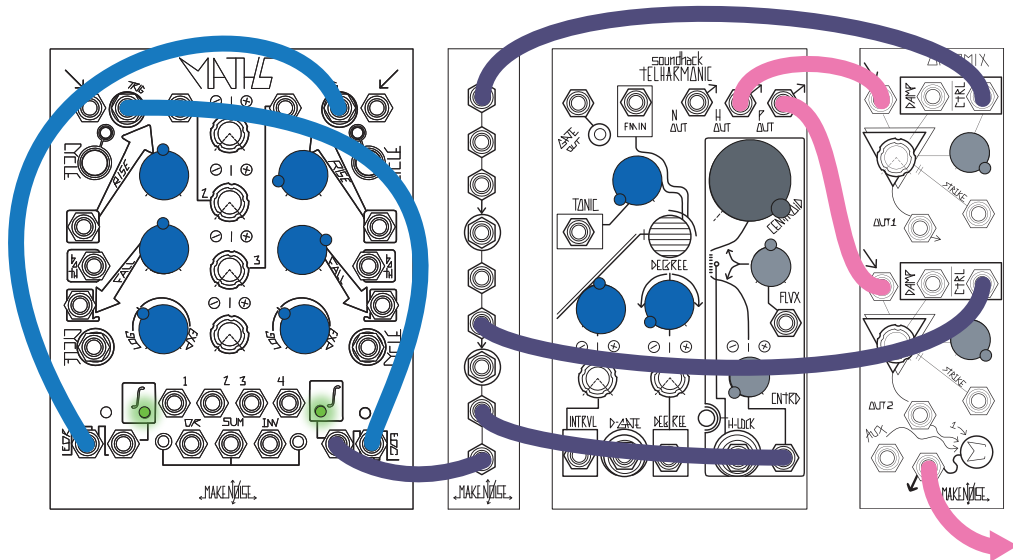

Briefly turn on MATHS Ch. 1 Cycling and wait for Ch. 4 to be triggered via EOR. At which point, press the Ch.1 CYCLE Button again in order to disengage cycling, allowing the trigger loop to continue indefinitely.

# Patch Example:

## Stereo Spiralgraph (Thanks, Tony!):

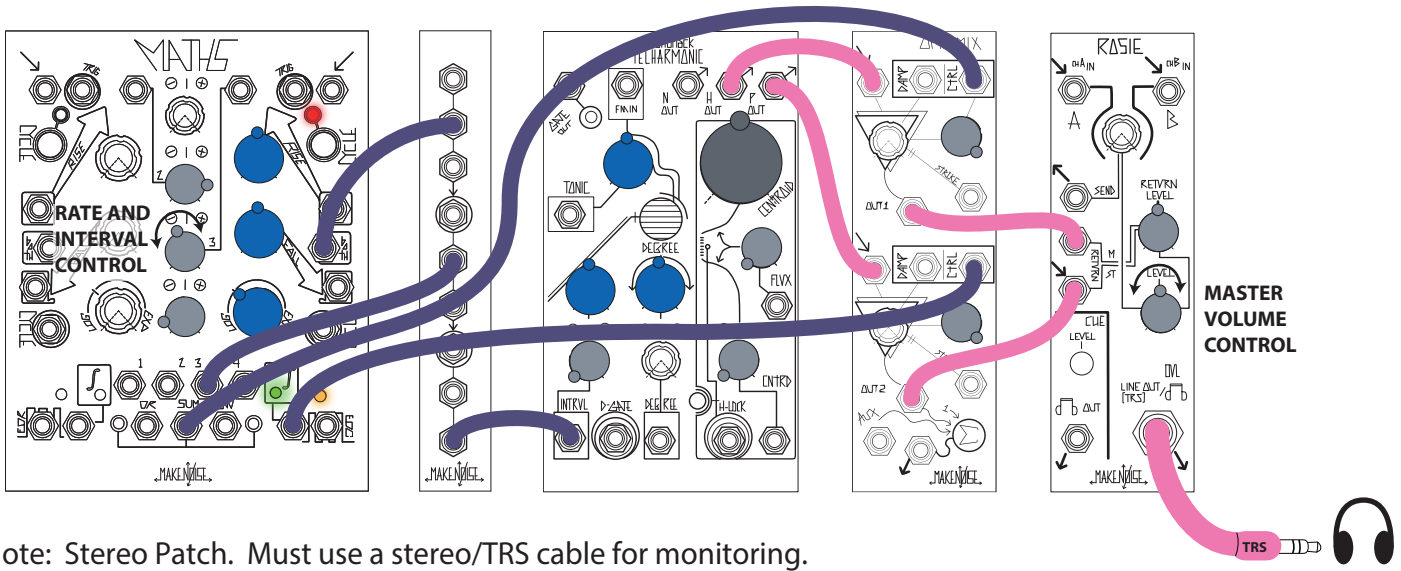

Note: Stereo Patch. Must use a stereo/TRS cable for monitoring.