

Model: **XK-5** Release 3

Thank you, and congratulations on your choice of the Hammond Drawbar Keyboard XK-5.

The XK-5 Drawbar Keyboard is condensed the sound and playability of the legendary Hammond Tone Wheel organ.

Please take the time to read this manual completely to take full advantage of the many features of your XK-5; and please retain it for future reference.

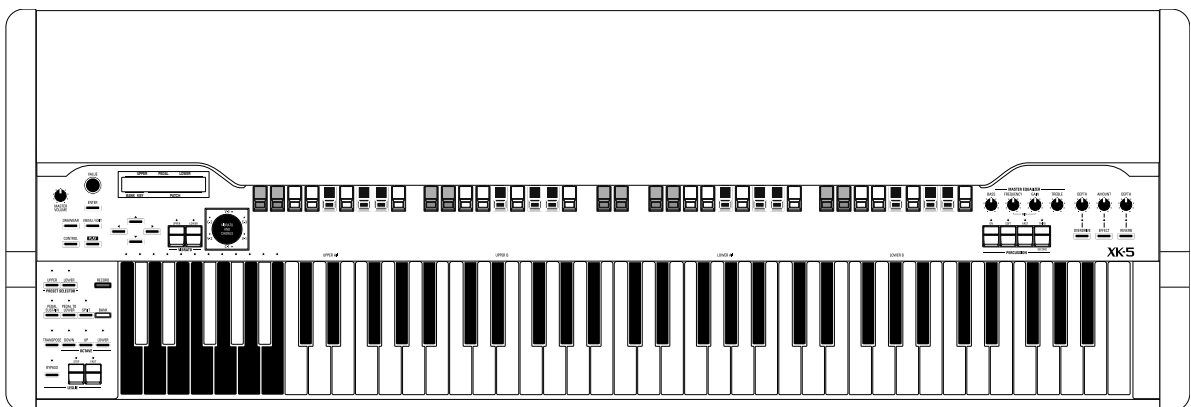

Owner's Manual

IMPORTANT SAFETY INSTRUCTIONS

Read these instructions.

Keep these instructions.

Heed all warnings.

Follow all instructions.

Do not use this apparatus near water.

Clean only with dry cloth.

Do not block any ventilation openings.

Install in accordance with the manufacturer's instructions.

Do not install near any heat sources such as radiators, heat registers, stoves or other apparatus (including amplifiers) that produce heat.

Do not defeat the safety purpose of the polarized or grounding-type plug. A polarized plug has two blades with one wider than the other. A grounding type plug has two blades and a third grounding prong. The wider blade or third prong is provided for your safety. If the provided plug does not fit into your outlet, consult an electrician for replacement of the obsolete outlet.

Protect the power cord from being walked on or pinched, particularly at plugs, convenience receptacles, and the point where they exit from the apparatus.

Only use attachments/accessories specified by the manufacturer.

Use only with the cart, stand, tripod, bracket, or table specified by the manufacturer, or sold with the apparatus. When cart is used: use caution when moving the cart/apparatus combination to avoid injury from tip-over.

PORTABLE CART WARNING



S3125A

Unplug this apparatus during lightning storms, or when unused for long periods of time.

Refer all servicing to qualified service personnel. Servicing is required when the apparatus has been damaged in any way, such as power-supply cord or plug is damaged, liquid has been spilled or objects have fallen into the apparatus, the apparatus has been exposed to rain or moisture, does not operate normally, or has been dropped.

Apparatus shall not be exposed to dripping or splashing and no objects filled with liquids, such as vases, shall be placed on the apparatus.

WARNING: To reduce the risk of fire or electric shock, do not expose this apparatus to rain or moisture.

ATTENTION: Pour réduire les risques de choc électrique ou d'incendie, ne pas exposer cet appareil à la pluie ou à l'humidité.

-THIS APPARATUS MUST BE EARTHED.

-The socket-outlet shall be installed near the apparatus and shall be easily accessible.

	CAUTION RISK OF ELECTRIC SHOCK DO NOT OPEN	
<p>注意:感電の恐れありキャビネットをあけるな ATTENTION : RISQUE DE CHOC ELECTRIQUE NE PAS OUVRIR WARNING: TO REDUCE THE RISK OF FIRE OR ELECTRIC SHOCK, DO NOT EXPOSE THIS APPLIANCE TO RAIN OR MOISTURE.</p>		

	The lightning flash with arrowhead symbol within an equilateral triangle, indicates that dangerous voltage constituting a risk of electric shock is present within this unit.
	The exclamation point within equilateral triangle, indicates that there are important operating and maintenance instructions in the literature accompanying this unit.

	In case in the future your instrument gets too old to play/use or malfunctions beyond repair, please observe the instructions of this mark, or, if any question, be sure to contact your dealer or your nearest town or municipal office for its proper disposal.
--	---



FOR UNITED KINGDOM:

FOR YOUR SAFETY, PLEASE READ THE FOLLOWING TEXT CAREFULLY

This appliance is supplied with a molded 3-pin mains plug for your safety and convenience.

The plug contains a 13 amp fuse.

Should the fuse need to be replaced, please ensure that the replacement fuse has a rating of 13 amps and that it is approved by ASTA or BSI to BS11362.

Check for the ASTA mark  or the BSI mark  on the body of the fuse.

If the plug contains a removable fuse cover, you must ensure that it is refitted when the fuse is replaced.

If the fuse cover is lost, the plug must not be used until a replacement cover is obtained.

A replacement fuse cover can be obtained from your local Hammond Dealer.

IF THE FITTED MOULDED PLUG IS UNSUITABLE FOR THE SOCKET OUTLET IN YOUR HOME, THEN THE FUSE SHOULD BE REMOVED AND THE PLUG CUT OFF AND DISPOSED OF SAFELY.

THERE IS A DANGER OF SEVERE ELECTRICAL SHOCK IF THE CUT-OFF PLUG IS INSERTED INTO ANY 13 AMP SOCKET.

To replace the fuse, open the fuse compartment with a screwdriver and replace the fuse and fuse cover.

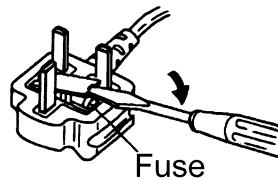

IMPORTANT - PLEASE READ

◆ Power Supply

- ◆ Do not use this unit on the same power circuit with any device that will generate line noise (such as an electric motor or variable lighting system).
- ◆ Before connecting this unit to other devices, turn off the power to all units. This will help prevent malfunctions and/or damage to speakers or other devices.
- ◆ This unit features an Auto Power Off function that automatically turns the power off if the unit is not operated for a specified period of time. The setting will revert to its default value if not backed up before the power is turned off.

◆ Placement

- ◆ Using the unit near power amplifiers (or other equipment containing large power transformers) may induce hum. To alleviate the problem, change the orientation of this unit; or move it farther away from the source of interference.
- ◆ This device may interfere with radio and television reception. Do not use this device in the vicinity of such receivers.
- ◆ Noise may be produced if wireless communications devices, such as cell phones, are operated in the vicinity of this unit. Such noise could occur when receiving or initiating a call, or while conversing. Should you experience such problems, you should relocate such wireless devices so they are at a greater distance from this unit, or switch them off.
- ◆ Do not expose the unit to direct sunlight, place it near devices that radiate heat, leave it inside an enclosed vehicle, or otherwise subject it to temperature extremes. Also, do not allow lighting devices that normally are used while their light source is very close to the unit (such as a piano light), or powerful spotlights to shine upon the same area of the unit for extended periods of time. Excessive heat can deform or discolor the unit.
- ◆ When moved from one location to another where the temperature and/or humidity is very different, water droplets (condensation) may form inside the unit. Damage or malfunction may result if you attempt to use the unit in this condition. Therefore, before using the unit, you must allow it to stand for several hours, until the condensation has completely evaporated.
- ◆ Do not allow rubber, vinyl, or similar materials to remain on the unit for long periods of time. Such objects can discolor or otherwise harmfully affect the finish.
- ◆ Do not paste stickers, decals, or the like to this instrument. Peeling such matter off the instrument may damage the exterior finish.

◆ Maintenance

- ◆ To clean the unit, use a dry, soft cloth; or one that is slightly dampened.
- ◆ To remove stubborn dirt off plastic parts, use a cloth impregnated with a mild, non-abrasive detergent. Afterwards, be sure to wipe the unit thoroughly with a soft, dry cloth. Try to wipe the entire surface using an equal amount of strength, moving the cloth along with the grain of the wood. Rubbing too hard in the same area can damage the finish.

- ◆ Never use benzene, thinners, alcohol or solvents of any kind, to avoid the possibility of discoloration and/or deformation.

◆ Additional Precautions

- ◆ Please be aware that the contents of memory can be irretrievably lost as a result of a malfunction, or the improper operation of the unit. To protect yourself against the risk of losing important data, we recommend that you periodically save a backup copy of important data you have stored in the unit's memory in USB Flash drive.
- ◆ Unfortunately, it may be impossible to restore the contents of data that was stored in another MIDI device (e.g., a sequencer) once it has been lost. Hammond assumes no liability concerning such loss of data.
- ◆ Use a reasonable amount of care when using the unit's buttons, sliders, or other controls; and when using its jacks and connectors. Rough handling can lead to malfunctions.
- ◆ When connecting / disconnecting all cables, grasp the connector itself - never pull on the cable. This will avoid causing short circuits, or damage to the cable's internal elements.
- ◆ To avoid disturbing your neighbors, try to keep the unit's volume at reasonable levels. You may prefer to use headphones, so you do not need to be concerned about those around you (especially when it is late at night).
- ◆ When you need to transport the unit, package it in the box (including padding) that it came in, if possible. Otherwise, you will need to use equivalent packaging materials.

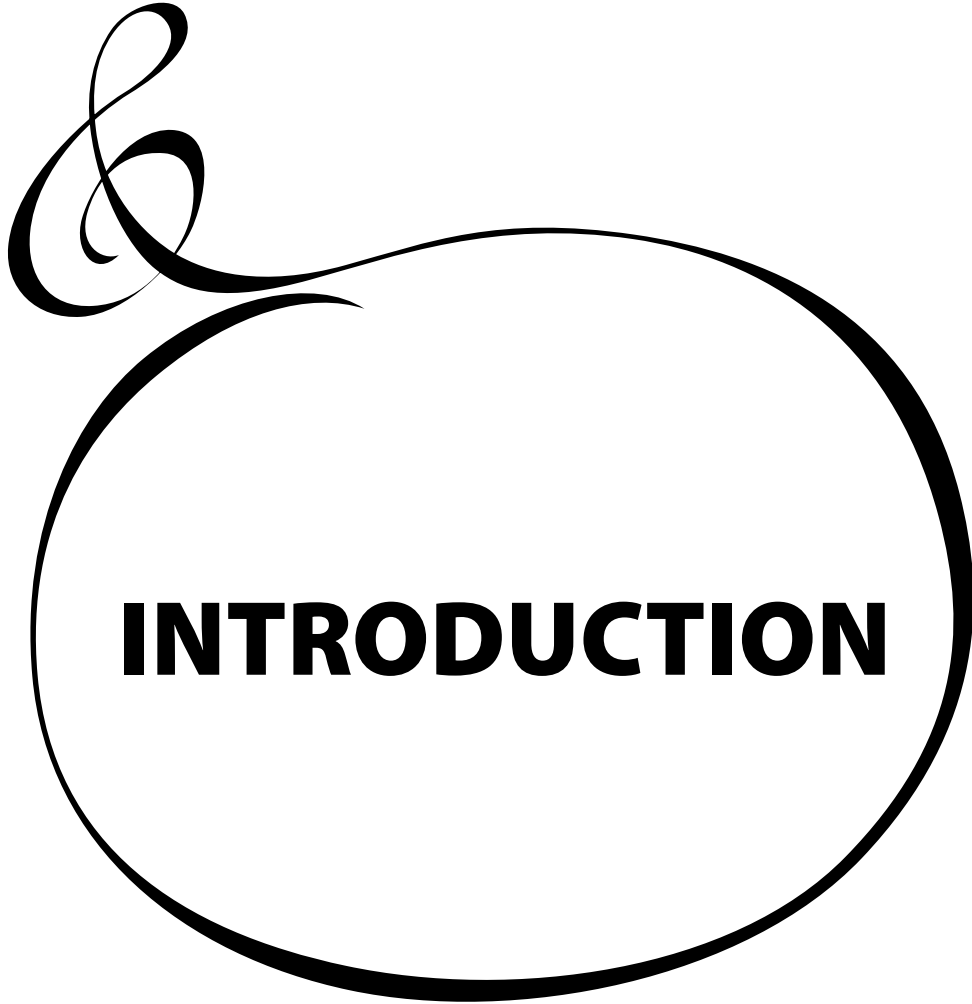

INTRODUCTION

Table Of Contents

IMPORTANT SAFETY INSTRUCTIONS.....	2	EXPRESSION PEDAL	32
IMPORTANT - PLEASE READ.....	4	FOOT SWITCH.....	32
INTRODUCTION	5	LESLIE MODE SWITCH	32
MAIN FEATURES	9	TEMPORARY EQUALIZING (MASTER EQUALIZER)	33
NAMES AND FUNCTIONS	10	TRY TO MAKE YOUR OWN SOUND.....	34
TOP PANEL.....	10	SELECT [B] PRESET KEY	34
RECESS.....	12	Column: Initializing Adjust Presets.....	34
ACCESSORIES.....	12	PULL OUT THE "B" DRAWBARS.....	35
REAR PANEL	13	ADD THE TOUCH-RESPONSE PERCUSSION.....	35
HOOK-UP	15	Column: What is "Part"?	35
BASIC HOOK-UP	16	ADD EFFECTS	36
CONNECTING THE CONTROLLERS.....	17	◆ VIBRATO AND CHORUS.....	36
CONNECTING THE EXPRESSION PEDAL	17	◆ LESLIE.....	36
◆ USING EXP-100F.....	17	◆ OVERDRIVE.....	36
◆ USING EXP-50J/20.....	17	◆ MULTI EFFECT.....	36
CONNECTING THE LESLIE SWITCH CU-1	17	SPLIT - DIVIDE THE KEYBOARD BY PARTS.....	37
CONNECTING THE LESLIE SPEAKER	18	PEDAL TO LOWER - ADD BASS TO PLAYING LOWER.....	37
CONNECTING THE 3 CHANNEL LESLIE SPEAKER	18	PEDAL SUSTAIN - SMOOTH DECAY WHEN RELEASE.....	37
BASIC CONNECTION OF THE LESLIE SPEAKER.....	18	RECORD THE PATCH TO MEMORY	38
MIDI CONTROL OF THE LESLIE SPEAKER	18	◆ Example: RECORD TO U32	38
CONNECTING THE 1 CHANNEL LESLIE SPEAKER	19	◆ Example: RECORD TO D#-D (U32)	38
BASIC CONNECTION OF THE LESLIE SPEAKER.....	19	SETTING UP	39
USING WITH STATIONARY SPEAKERS.....	19	SOUND ENGINE STRUCTURE.....	40
EXPAND THE KEYBOARD.....	20	ORGAN TYPE	42
3 KEYBOARDS (USING XLK-5 AND XPK-250)	20	WHAT IS "ORGAN TYPE"?	42
3 KEYBOARDS (USING MIDI KEYBOARDS).....	21	◆ TONE WHEELS (A-100, B-3, C-3, Mellow).....	42
2 MANUALS (WITH XLK-5).....	22	◆ TRANSISTOR (Vx, Farf).....	42
2 MANUALS (WITH MIDI KEYBOARD)	23	◆ PIPE	42
1 MANUAL + PEDALBOARD (WITH MIDI PEDALBOARD)	24	Column: SELECTING THE ORGAN TYPES.....	43
POWER ON AND PLAY.....	25	◆ Example: Switching the manual part to "Pipe".....	43
POWER ON	26	HARMONIC DRAWBARS™	44
HOW TO POWER ON	26	DRAWBARS (ON TONE WHEEL ORGAN)	44
BACK UP	26	DRAWBARS FOR THE UPPER AND LOWER PARTS	45
AUTO POWER OFF	26	◆ PRESET KEYS AND DRAWBARS.....	45
RESET TO THE FACTORY SETTINGS	26	DRAWBARS FOR PEDAL PART.....	45
PLAY WITH THE PATCHES	27	DRAWBAR REGISTRATION PATTERNS.....	46
WHAT IS "PATCH"?	27	MODERN DRAWBAR REGISTRATIONS.....	47
HOW TO RECALL A PATCH.....	27	DRAWBARS (Vx).....	48
◆ ex: Recall the U41	27	DRAWBARS (Farf).....	49
PLAY WITH PRESET KEYS	28	DRAWBARS (PIPE)	50
WHAT ARE "PRESET KEYS"?	28	MATCH THE REGISTRATION TO DRAWBARS.....	51
RECALL BY PRESET KEYS.....	28	PERCUSSION.....	52
◆ ex: Recall C#-G.....	28	◆ PERCUSSION DOES NOT SOUND.....	52
ASSIGN FAVORITE PATCHES (FAVORITES)	29	◆ 1' DRAWBAR CANCEL.....	52
WHAT IS "FAVORITE" ?	29	VIBRATO & CHORUS.....	53
THE FAVORITE FUNCTION	29	OVERDRIVE.....	54
◆ Favorites is "Off"	29	LESLIE.....	55
◆ Favorites is "On"	29	MULTI EFFECTS, REVERB.....	56
SWITCHING FAVORITE ON AND OFF	30	TRANPOSE	57
ASSIGN A PATCH TO A PRESET KEY.....	31	SPLIT, OCTAVE.....	58
USING CONTROLLERS	32	PEDAL TO LOWER, PEDAL SUSTAIN.....	59
		PATCH.....	60
		USER AND FACTORY.....	60
		PATCH, FAVORITES, PRESET KEYS.....	60
		◆ PATCH.....	60
		◆ FAVORITES	60

◆ PRESET KEYS	60
NAME THE PRESENT SETTING	61
RECORD TO THE PATCH	62

USING THE CONTROL PANEL..63

WHAT YOU CAN DO ON THE CONTROL PANEL	64
PLAY MODE	65
HOW TO READ THE DISPLAY	65
OPERATION IN THIS MODE	65
MENU MODE	66
HOW TO READ THE DISPLAY	66
OPERATION IN THIS MODE	66
MENU AND THE CONTENTS	67
FUNCTION MODE	68
HOW TO READ THE DISPLAY	68
OPERATION IN THESE MODES	68
PARAMETER OPERATION EXAMPLE:	69
SHORT CUT TO FUNCTION MODE	71
EXAMPLE OF OPERATION:	71
◆ LOCATE THE PERCUSSION FUNCTION MODE	71
REGISTER THE PAGE YOU FREQUENTLY USE	71
EXAMPLE OF OPERATION:	71
LOCKING THE DISPLAY	72

SETTING THE PARAMETERS ...73

DRAWBAR	74
◆ LOWER & UPPER PARTS	74
◆ PEDAL PART	75
PATCH	76
◆ PATCH NAME	76
◆ PATCH LEVEL	76
◆ PATCH RECALL	76
◆ PATCH LOAD	76
◆ PRESET KEYS	77
◆ FAVORITE TABLE	77
CONTROL	78
◆ FOOT CONTROLLER	78
◆ EXPRESSION	79
◆ GLIDE	79
◆ DAMPER	80
◆ SUSTAIN	80
◆ ASSIGN	80
◆ DRAWBARS	80
◆ DISPLAY	81
Column: EXPRESSION, LESLIE MODE	82
◆ ACTIVATE EXPRESSION PEDAL	82
TUNE	83
◆ MASTER TUNE	83
PERCUSS (<u>P</u> ercussion)	84
VIB&CHO (<u>V</u> ibrato & <u>C</u> horus)	85
LESLIE	86
◆ CABINET NUMBER	86
◆ LESLIE PARAMETERS	86
◆ EXTERNAL LESLIE SPEAKER	88
RECORD THE CUSTOM CABINET	88
RECORD THE CUSTOM TONE WHEELS	89
RECORD THE CUSTOM TONE WHEELS	91
CONTACT	92

◆ SELECT CONTACT	92
◆ CONDITION	93
◆ PHYSICAL CONTACT	93
RECORD THE CUSTOM CONTACTS	94
Column: CONTACTS OF THE B-3/C-3 AND VIRTUAL CONTACTS	95

PED. REG (<u>P</u> edal <u>R</u> egistration <u>S</u> ub <u>D</u> rawbars)	96
RECORD THE SUB DRAWBARS	97
PIPE	98
RECORD THE CUSTOM PIPES	100
AMP / EFF (<u>P</u> re- <u>A</u> mplifier / <u>M</u> ulti- <u>E</u> ffects)	101
◆ TUBE PRE-AMPLIFIER	101
◆ MATCHING TRANSFORMER	101
◆ OVERDRIVE	102
◆ MULTI-EFFECTS	103
EQUALIZ (<u>E</u> qualizer)	110
◆ PATCH EQUALIZER	110
◆ PATCH EQUALIZER AND MASTER EQUALIZER	110
REVERB	111
DEFAULT	112
SYSTEM	113
◆ POWER	113
◆ USB	113
◆ PERIPHERAL DEVICE	113
◆ SOFTWARE VERSION	113
Column: Tube without distortion?	114
The tube circuits of 12AX7 and 12AU7 on this unit do not actively distort. The so-called Clipping Distortion is made with the Overdrive Effects	114
◆ What is Non-linear Distortion?	114
◆ Sound Characteristics	114
◆ Difference Characteristics by Tubes	114
◆ Pre or post of the Expression	114
◆ Influences to the Performance	114

MIDI/USB115

MIDI/USB	116
WHAT IS "MIDI"?	116
WHAT IS "USB"?	116
MIDI/USB JACKS ON THIS KEYBOARD	116
WHAT MIDI CAN DO ON THIS KEYBOARD	116
WHAT THE USB TO HOST CAN DO ON THIS KEYBOARD	116
MAIN MIDI MESSAGE	117
◆ CHANNEL MESSAGE	117
◆ SYSTEM MESSAGE	117
MIDI STRUCTURE	118
◆ KEYBOARD CHANNELS	118
◆ EXTERNAL ZONE CHANNELS	118
◆ EXPANDED KEYBOARDS	118
USING AN EXTERNAL SEQUENCER	120
◆ Recording a organ performance to an Sequencer/DAW	120
◆ Sequencer playback	120
◆ Recording a performance to an computer DAW over USB	121
◆ Recording a performance with using XLK-5 XPK-250W	121
USING A MIDI SYNTHESIZER	122
BASIC HOOK UP	122
RECORD AND PLAYBACK	123
◆ Recording a performance to a sequencer/DAW	123
◆ Playback the performance	123
◆ Recording the performance including External Zones over USB	124
H-BUS	125

ZONES.....	126	PIPE PARAMETERS	159
◆ WHAT IS DISPLAYED ON THE UPPER LEFT?.....	126	PEDAL SUB DRAWBARS PARAMETERS	159
◆ INTERNAL ZONE	126	CONTACT PARAMETERS.....	159
◆ EXTERNAL ZONE.....	126	SYSTEM PARAMETERS	160
◆ MESSAGE ON/OFF	127	FOOTAGE LABEL.....	161
◆ PANIC FUNCTION AND PARAMETER RE-LOAD	127	CUSTOM SETS LIST	163
MIDI.....	128	CUSTOM TONE WHEELS.....	163
◆ MIDI TEMPLATE.....	128	CUSTOM CONTACT.....	163
◆ MASTER	128	CUSTOM SUB DRAWBARS.....	163
◆ KEYBOARD CHANNEL.....	129	CUSTOM CABINETS.....	163
◆ SYSTEM EXCLUSIVE MESSAGE.....	129	CUSTOM PIPES.....	163
SAVE THE SETUP	131	MIDI IMPLEMENTATION CHART.....	164
SAVE YOUR SETUP	132	MIDI CHANNEL AND MESSAGE	165
WHAT YOU CAN DO WITH THE USB FLASH DRIVE.....	132	SPECIFICATIONS.....	166
ABOUT USB FLASH DRIVE	132	SERVICE.....	169
◆ USABLE USB FLASH DRIVE.....	132		
◆ USB CONNECTOR.....	132		
◆ FOLDER STRUCTURE.....	132		
INITIALIZE THE USB FLASH DRIVE.....	133		
A SETUP FILE	134		
USB MASS STORAGE.....	135		
WHAT IS USB MASS-STORAGE?	135		
SWITCHING THE FUNCTION OF USB-TO-HOST JACK.....	135		
SAVE THE SETUP.....	136		
HOW TO READ THE DISPLAY	136		
SAVE THE SETUP	136		
LOAD THE SETUP	138		
HOW TO READ THE DISPLAY	138		
LOAD THE SETUP.....	138		
DELETE THE SETUP.....	140		
HOW TO READ THE DISPLAY	140		
DELETE THE SETUP	140		
UPDATE	142		
WORKING TIME AND SECURING THE POWER	142		
◆ THE UPDATOR DOES NOT FOUND.....	142		
FREQUENTLY ASKED QUESTIONS.....	145		
TROUBLESHOOTING.....	146		
APPENDIX.....	147		
MIDI TEMPLATE	148		
MIDI TEMPLATE.....	148		
FACTORY PATCHES	149		
MIDI INFORMATION.....	150		
MIDI IMPLEMENTATION	150		
◆ CHANNEL VOICE MESSAGE	150		
◆ CHANNEL MODE MESSAGE.....	150		
DRAWBARS DATA LIST 1	151		
DRAWBAR DATA LIST 2.....	151		
SYSTEM EXCLUSIVE MESSAGE.....	152		
GLOBAL PARAMETERS.....	153		
PATCH PARAMETERS	154		
FAVORITES	158		
LESLIE PARAMETERS	158		
TONE WHEEL PARAMETERS	159		

◆ AUTHENTIC HAMMOND DRAWBAR ORGAN

The XK-5 is first and foremost a genuine HAMMOND organ with Virtual Tone Wheels to provide its traditional sound. Also available are the tones of vintage “combo” organs, and a variety of pipe organ ranks to provide church and classical organ voices.

◆ VIRTUAL MULTI-CONTACT KEYBOARD

The XK-5 is equipped with a Virtual Multi-Contact Keyboard to produce the comfortable feeling and quick response of the vintage models B-3/C-3. Enjoy a variety of types of the Multi-Contact essence, from the delicate sound produced just before all the points perfectly touch, to the changes of noises in accordance with the contact conditions.

The XK-5 is equipped with a Virtual Multi-Contact Keyboard to produce the comfortable feeling and quick response of models such as the B-3/C-3. The unique “touch” of a Vintage Hammond, where the different harmonics sound in sequence as a key is pressed, is now at your fingertips. All of the iconic Hammond performance techniques or “Moves” used by legendary Hammond players have the familiar response and sound.

◆ 5 SETS OF DRAWBARS & PRESET KEYS

5 sets of Drawbars and the Preset Keys same as on the B-3/C-3 are equipped to enable an instant switching to the Drawbar settings prepared beforehand and dynamic tone changes during performance.

◆ DIGITAL LESLIE/VIBRATO

A digital and programmable Leslie is available for the Drawbar voices, as well as the traditional “Chorus-Vibrato” as used on the legendary B-3/C-3.

◆ AMP SIMULATOR/EFFECTS

The tube circuits simulate the pre-amplifier of the B-3/C-3 to provide “tube warmth.” Four different “non-linear distortion” Preamp Emulation Profiles allow you to add tube warmth to the Overdrive. Also equipped are an Equalizer, Multi-Effects, and, in addition, a Master Equalizer for adjusting the total tonal quality. This corresponds with the sporadic unexpected requirements during performance.

◆ MIDI MASTER KEYBOARD

External Zones are available to enable the XK-5 to be used as a master keyboard.

◆ PATCHES AND FAVORITES

The XK-5 has several different “Preset Banks” which allow the reverse-color Preset Keys to be programmed with a number of different settings. The Preset Keys can be assigned to patches within the selected Bank, or can be re-assigned as “Favorites” recalling your choice of patches from any of the Preset Banks.

◆ SYSTEM EXPANSION

You can expand the XK-5 to a console-style organ by adding the optional Lower Keyboard XLK-5 and the Pedal Keyboard XPK-250W.

◆ USB COMPATIBILITY

The XK-5 has both USB “A” and “B” ports. The “A” port (“USB to Host”) enables easy System, MIDI, and Audio Communications with your Computer. The “B” port allows Backups and Software Upgrades which are simple procedures, using common USB ‘Flash’ Drives.

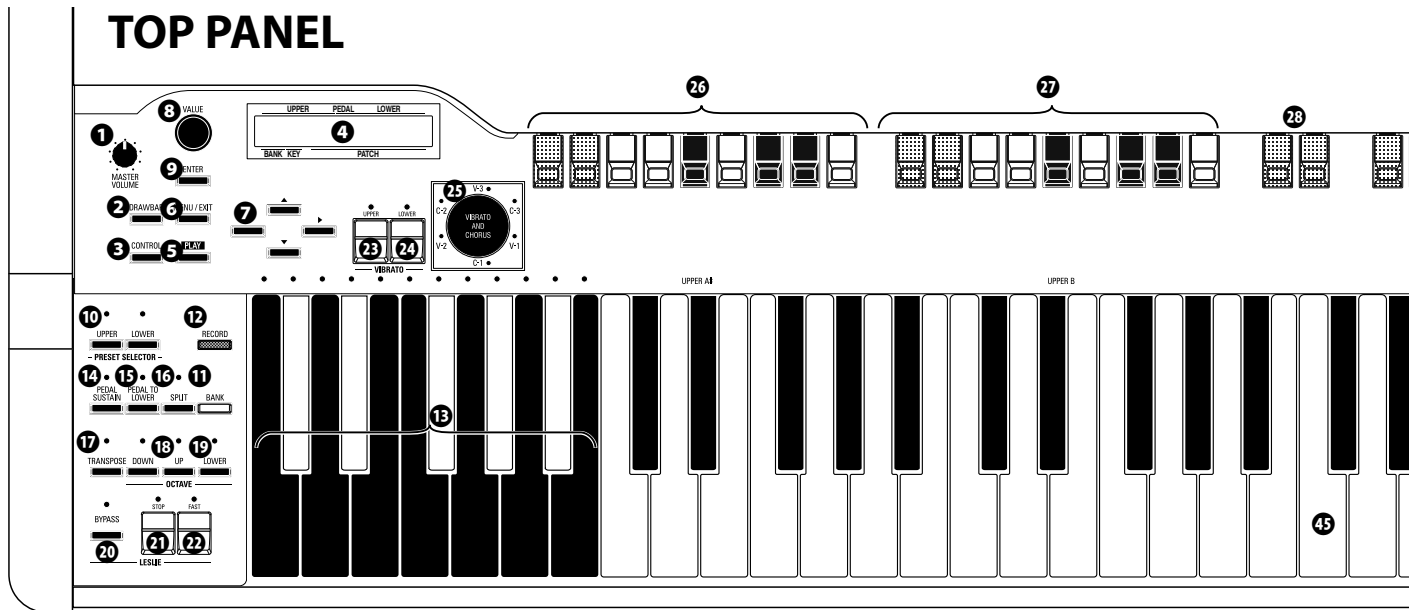

◆ UPPER LEFT

1 MASTER VOLUME knob

Controls the entire volume. (P. 26)

2 DRAWBAR button

Locates the DRAWBAR function page. (P. 43)

3 CONTROL button

Sets the various controllers such as foot switch or expression pedal. (P. 78)

◆ CONTROL PANEL

4 DISPLAY

Displays the various information.

5 PLAY button

Returns the display to basic playing mode. (P. 65)

6 MENU/EXIT button

Locates the MENU mode. Also, exit from various function pages. (P. 66)

7 CURSOR buttons

Moves the cursor or locates other pages.

8 VALUE knob

Increases/Decreases Patch numbers (P. 27) while performing or adjusts values (P. 68) during editing.

9 ENTER button

Confirms the current entry or procedure.

◆ PRESETS

10 PRESET SELECTOR buttons

Allocates the Preset keys which Upper or Lower part to select a Patch. (P. 28)

11 BANK button

Selects 10's digit of the Patch, or select the Bank of the Favorites. (P. 28)

12 RECORD button

Records a Patch, Favorite, or Leslie cabinets etc. (P. 38)

13 PRESET KEYS

Recalls and Records the Patch or Favorites.

The [A#] and [B] key recalls their exclusive Patch. It mates the internal states and corresponding Drawbars and each effect knob. (P. 28)

◆ KEYBOARD CONTROL

14 PEDAL SUSTAIN button

Switches the Pedal Sustain on. (P. 59)

15 PEDAL TO LOWER button

Allows the Pedal part to be played on the Lower manual or Lower part. (P. 59)

16 SPLIT button

Splits the keyboard into Upper and Lower parts. (P. 58)

17 TRANSPOSE button

Transposes the Key of the entire organ. (P. 57)

18 OCTAVE buttons

Transposes the Upper Part by ± 2 Octaves. (P. 58)

19 OCTAVE LOWER button

Controls the octave of the Lower part which use with [UP] and [DOWN] button together. (P. 58)

◆ LESLIE

20 BYPASS button

Bypasses the Leslie effect, and the sound is out from stationary channel. The LED lights at bypassed. (P. 55)

21 STOP button

Selects "Stop" or "Slow" the rotor mode when the [FAST] button is in "Off". The LED lights at "Stop". (P. 55)

22 FAST button

Select the "Fast" or not (slow or stop) the rotor mode. The LED lights at "Fast". (P. 55)

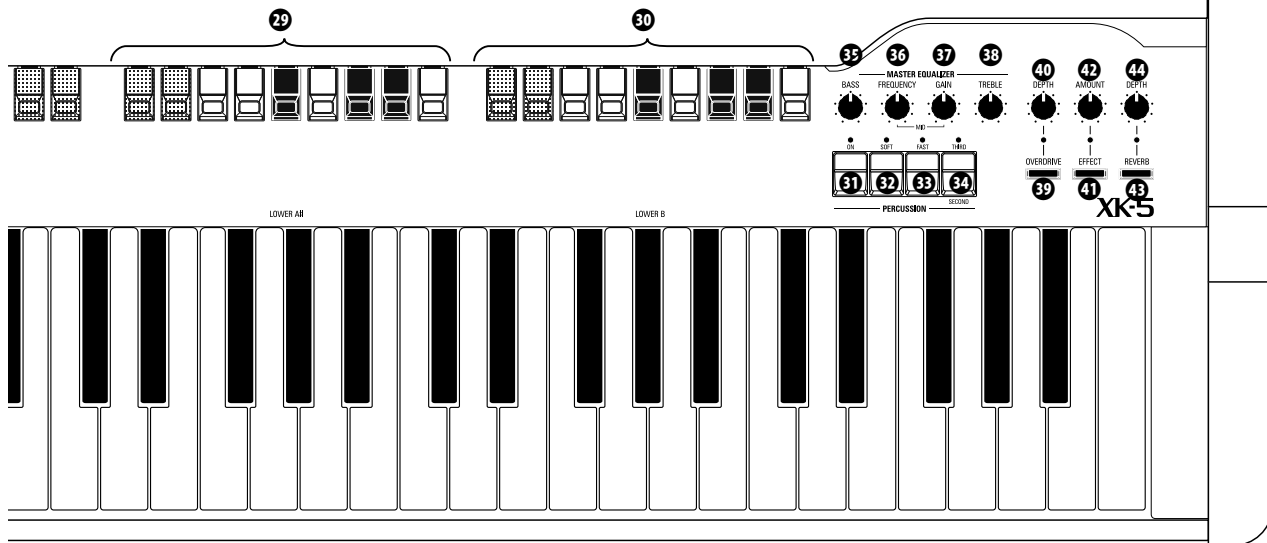

◆ VIBRATO AND CHORUS

- 23 UPPER button**
Switches the Vibrato & Chorus effect on the Upper part. (P. 53)
- 24 LOWER button**
Switches the Vibrato & Chorus effect on the Lower part. (P. 53)
- 25 VIBRATO & CHORUS MODE knob**
Selects the Vibrato & Chorus depth and switches the effect which Vibrato or Chorus. (P. 53)

◆ DRAWBARS

Drawbars adjusts the basic harmonics of the organ. (P. 44)

- 26 UPPER A# DRAWBARS**
These Drawbars for Upper part which enabled with the **10** Preset Selector [UPPER] button is in "On" and the **13** Preset key [A#] is selected.
- 27 UPPER B DRAWBARS**
These Drawbars for Upper part which enabled with the **10** Preset Selector [UPPER] button is in "On" and the **13** Preset key [B] is selected.
- 28 PEDAL DRAWBARS**
These Drawbars for Pedal part.
- 29 LOWER A# DRAWBARS**
These Drawbars for Upper part which enabled with the **10** Preset Selector [LOWER] button is in "On" and the **13** Preset key [A#] is selected.
- 30 LOWER B DRAWBARS**
These Drawbars for Upper part which enabled with the **10** Preset Selector [LOWER] button is in "On" and the **13** Preset key [B] is selected.

◆ PERCUSSION

- 31 ON button**
Adds percussion (decay) to the UPPER part. (P. 52)
- 32 SOFT button**
Switches the percussion volume. (P. 52)
- 33 FAST button**
Switches the decay time of the percussion. (P. 52)
- 34 THIRD button**
Switches the harmonic between second (4') and third (2 2/3') percussion (decay) to the UPPER part. (P. 52)

◆ MASTER EQUALIZER

- 35 BASS knob**
Adjusts the gain of the bass range. (P. 33)
- 36 MID FREQUENCY knob**
Adjusts the frequency of the middle range. (P. 33)
- 37 MID GAIN knob**
Adjusts the gain of the middle range. (P. 33)
- 38 TREBLE knob**
Adjusts the gain of the treble range. (P. 33)

◆ EFFECTS

- 39 OVERDRIVE ON button**
Switches the Overdrive effect. (P. 54)
- 40 OVERDRIVE DEPTH**
Adjusts the depth of the Overdrive effect. (P. 54)
- 41 EFFECT ON button**
Switches the Multi-Effects. (P. 56)
- 42 EFFECT AMOUNT knob**
Adjusts the amount of the Multi-Effects. (P. 56)

12 NAMES AND FUNCTIONS - continued

43 REVERB ON button

Switches the Reverb effect. (P. 56)

44 REVERB DEPTH knob

Adjusts the depth of the Reverb effect. (P. 56)

◆ KEYBOARD

45 KEYBOARD

61 notes of musical keys, 12 notes of Preset keys, water-fall type, non-weighted, virtual multi-contact keyboard. (P. 95)

RECESS

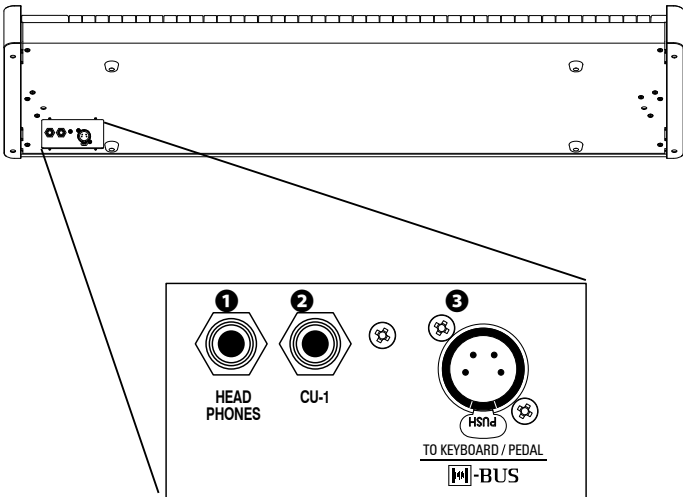

1 HEADPHONE jack

Connect stereo headphones here.

Connecting Headphones does NOT mute the Line or Leslie Outputs.

2 CU-1 jack

Connect CU-1 Leslie mode switch.

3 H-BUS jack

Connect XLK-5 Lower keyboard or XPK-250W Pedalboard with exclusive  -BUS cable.

ACCESSORIES

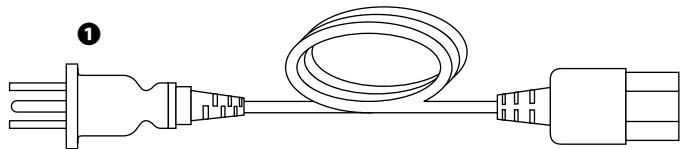

1 AC Cord Set

Supply the AC power.

REAR PANEL

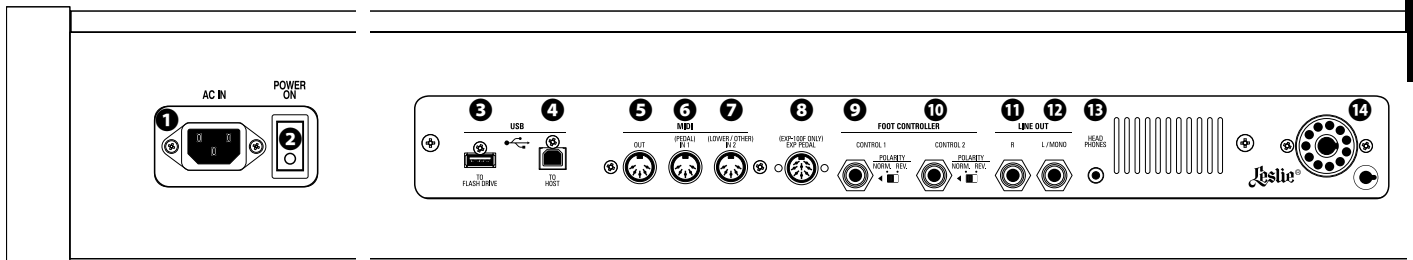

◆ POWER

❶ AC inlet

Connect the attached AC cord.

❷ POWER switch

Switches the power of this unit.

◆ USB JACKS

❸ USB FLASH DRIVE jack

Connects the USB Flash drive. (P. 132)

❹ USB TO HOST jack

Connects the (host) computer. (P. 116)

◆ MIDI JACKS

❺ MIDI OUT jack

Sends performance information. (P. 116)

❻ MIDI IN 1/PEDAL jack

Receives performance information. This jack receives with regarding specified MIDI channels. Also, use to connect a Pedalboard such as Hammond XPK-200L/PK-25P XK regardless MIDI channel by the configuration. (P. 116)

❼ MIDI IN 2/OTHER jack

Receives performance information. This jack receives specified MIDI channels. Also, use to connect the Hammond XLK-3 or generic MIDI keyboard as used as Lower or Upper part regardless MIDI channel by the configuration. (P. 116)

◆ CONTROLLER JACKS

❽ EXP. PEDAL jack

Connects the Expression pedal (separately purchased EXP-100F) to control volume while playing. (P. 17)

❾ FOOT CONTROLLER 1 jack

❿ FOOT CONTROLLER 2 jack

Connects the foot switch (separately purchased FS-9H) or, Expression pedal (separately purchased EXP-50J/20). (P. 17)

Select the [POLARITY] switch to match foot controller.

HAMMOND

FS-9H, EXP-50, EXP-20, VFP1, V-20H, V-20R: NORM

KORG

EXP-2, XVP-10: REV

Roland

EV-5, EV-7: NORM

YAMAHA

FC4, FC5: NORM

FC3, FC7: REV

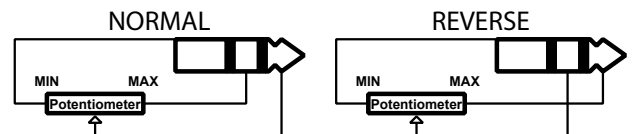

◆ AUDIO OUTPUT JACKS

❶ LINE OUT R jack

❷ LINE OUT L/MONO jack

Stereo audio outputs. For MONO operation, use the L/MONO jack only. (P. 16)

❸ HEADPHONES jack

Connecting the headphones will not mute the Line or Leslie outputs. (The Digital Leslie will be heard through the Headphones)

❹ LESLIE 11 PIN jack

Connects the Leslie speaker system. (P. 18)

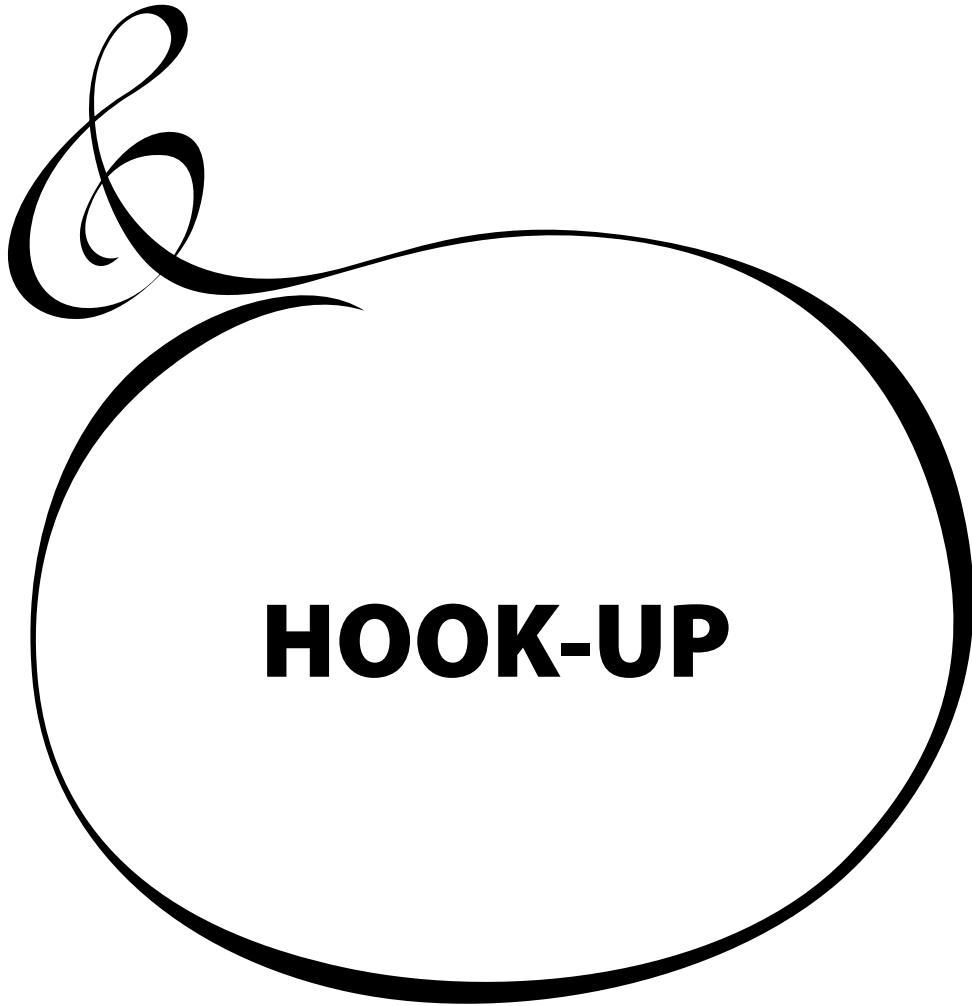

BASIC HOOK-UP

Connect audio cables and accessories as shown below.

The XK-5 is not self-contained - an external amplifier/speaker system is required in order to hear the sound. However, if you connect a set of stereo headphones to the PHONES jack, you can hear the sound through the headphones even if an external amplifier is not connected.

NOTE: Make sure both the instrument and amplifier are "OFF" before connecting amplifiers or headphones.

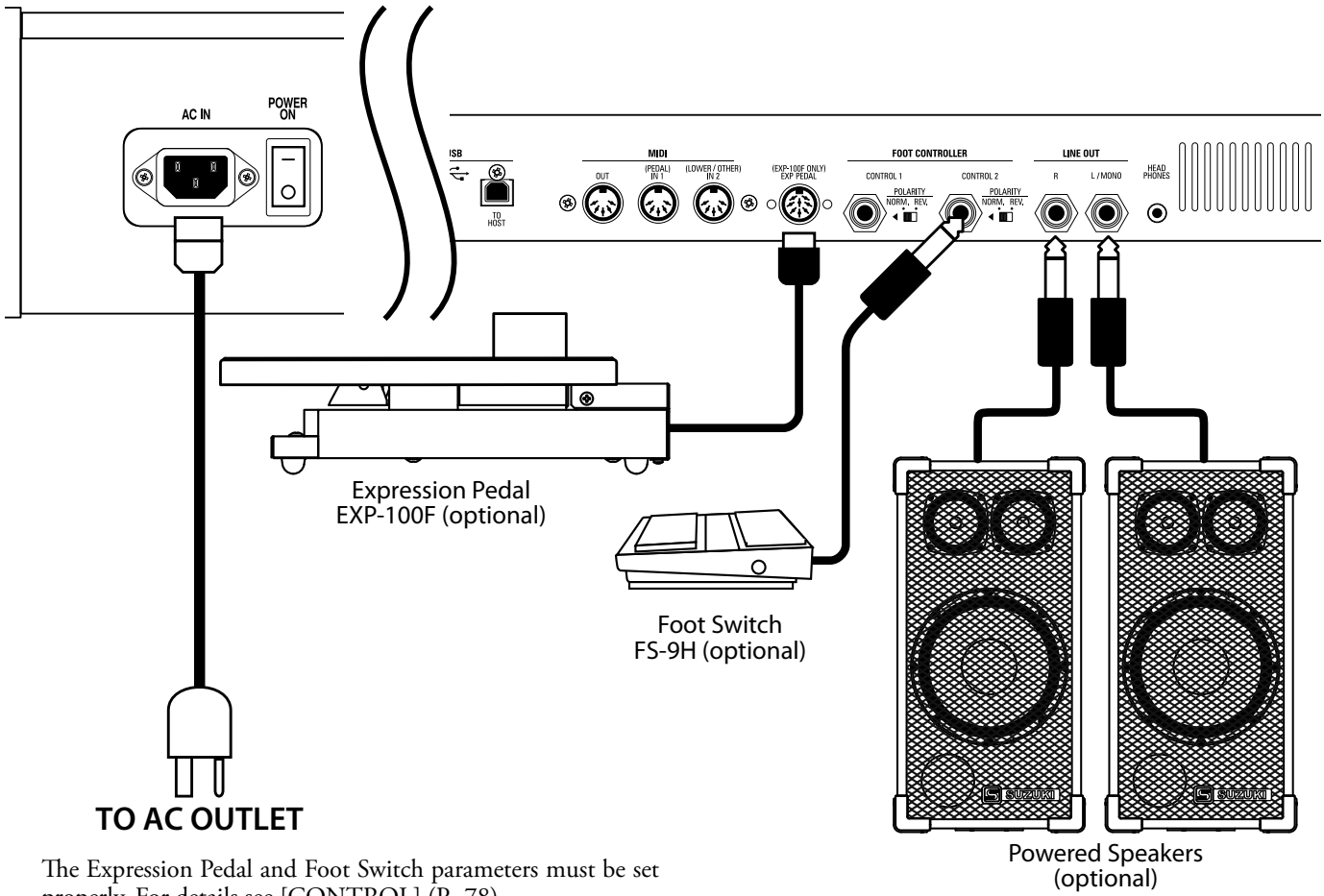

The Expression Pedal and Foot Switch parameters must be set properly. For details see [CONTROL] (P. 78)

⚠ CAUTION

Do not place this unit in direct sun light, near heat sources, or in a hot location.

CONNECTING THE EXPRESSION PEDAL

◆ USING EXP-100F

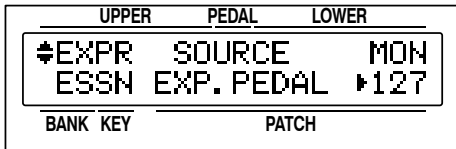
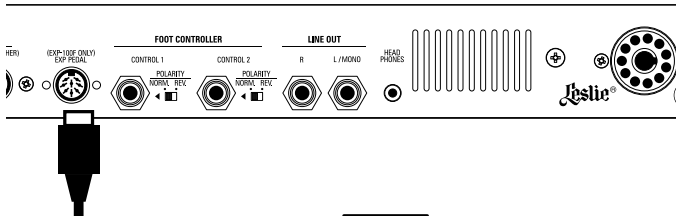

1. Connect the EXP-100F to the “EXP. PEDAL” jack.
2. Set the CONTROL - EXP. SOURCE at “EXP. PEDAL” or “BOTH” (P. 79 #4).

Hook-Up

◆ USING EXP-50J/20

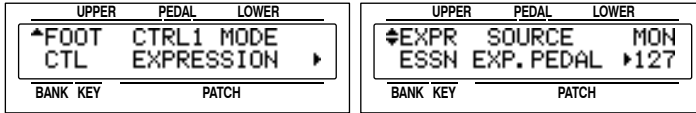
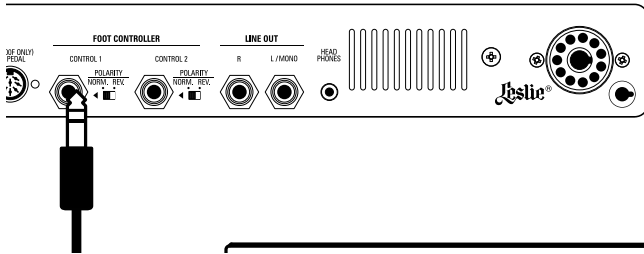

1. Make sure the [POWER] of this keyboard is “O”.
2. Connect the EXP-50J/20 to the FOOT CTRL 1/2 either.
3. Set the [POLARITY] at “NORM”.
4. Power the keyboard ON.
5. Set the CONTROL - FOOT CTL - CTRL 1/2 MODE at “EXPRESSION” (P. 78 #1).
6. Set the CONTROL - EXP. SOURCE at “EXP. PEDAL” or “BOTH” (P. 79 #4).

CONNECTING THE LESLIE SWITCH CU-1

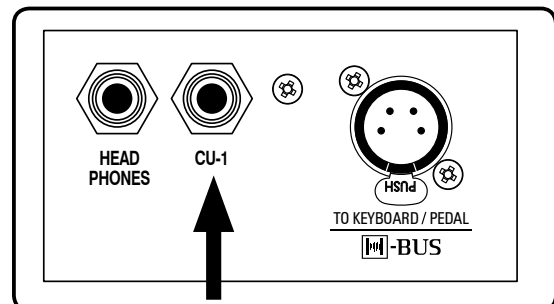
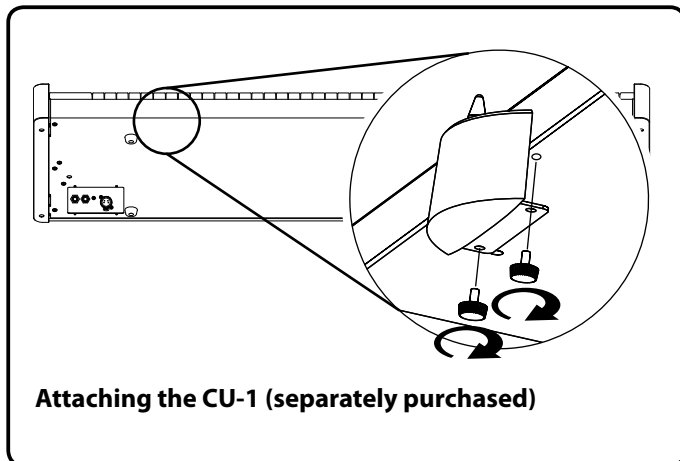

1. Insert the plug of the CU-1 to the “CU-1” jack of this keyboard.
- No parameter adjustments are necessary.

18 CONNECTING THE LESLIE SPEAKER

An 11-pin type Leslie speaker can be directly connected to this keyboard.

NOTE: Switch keyboard OFF before connecting the Leslie speaker.

CONNECTING THE 3 CHANNEL LESLIE SPEAKER

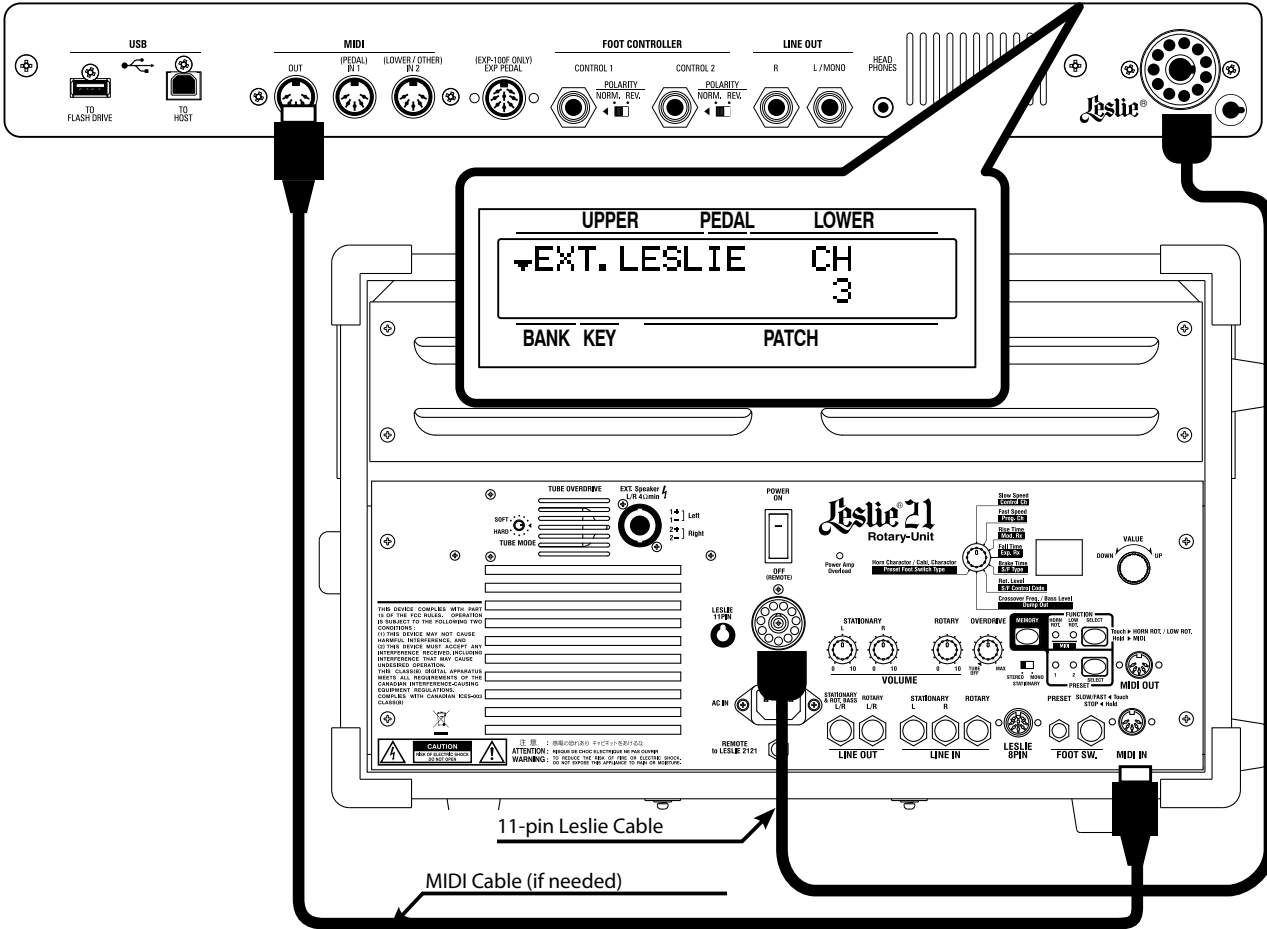

BASIC CONNECTION OF THE LESLIE SPEAKER

Connect the Leslie Speaker #2101/#2101mk2 and the Leslie 11-PIN jack on this keyboard with the exclusive 11-pin Leslie cable (not included).

1. Set the LESLIE - EXT. LESLIE CH at "3" (P. 88).
2. Switch "ON" the [BYPASS] button, set the [STATIONARY VOLUME] of the #2101/#2101mk2 at desired volume.
3. Repeat "ON/OFF" the [BYPASS] button with playing the keyboard, set the [ROTARY VOLUME] of the #2101/#2101mk2 at same volume which you can hear.

MIDI CONTROL OF THE LESLIE SPEAKER

To control the parameters of the Leslie Speaker #2101/#2101mk2 (fine adjustment of the rotor speed or the rise time, etc.):

1. Connect the MIDI OUT of this unit with the MIDI IN of the Leslie speaker with a MIDI cable.
2. Set the keyboard channel - UPPER and the Leslie MIDI channel to the same channel (P. 128).

When this unit detects that the Leslie speaker is connected, the Leslie parameters sent through MIDI from this unit are switched from the XK-5 original to those for the Leslie speaker.

tips

LESLIE SPEAKERS TO BE CONNECTED

This keyboard is designed to connect with 3 channel Leslie speakers such as the model #2101. However, it is also possible to connect 1 channel type Leslie speakers such as #3300 sending the stationary channels to the LINE OUT jacks independently. (P. 88)

tips LESLIE CHANNEL

3 channel type Leslie speakers are equipped with a stereo speaker system, independent of the rotor, to provide direct organ sounds. A traditional 1-channel Leslie, such as a #122 or #147 has no stationary speaker system, requiring a separate amplifier/speaker for the direct organ sounds.

CONNECTING THE 1 CHANNEL LESLIE SPEAKER

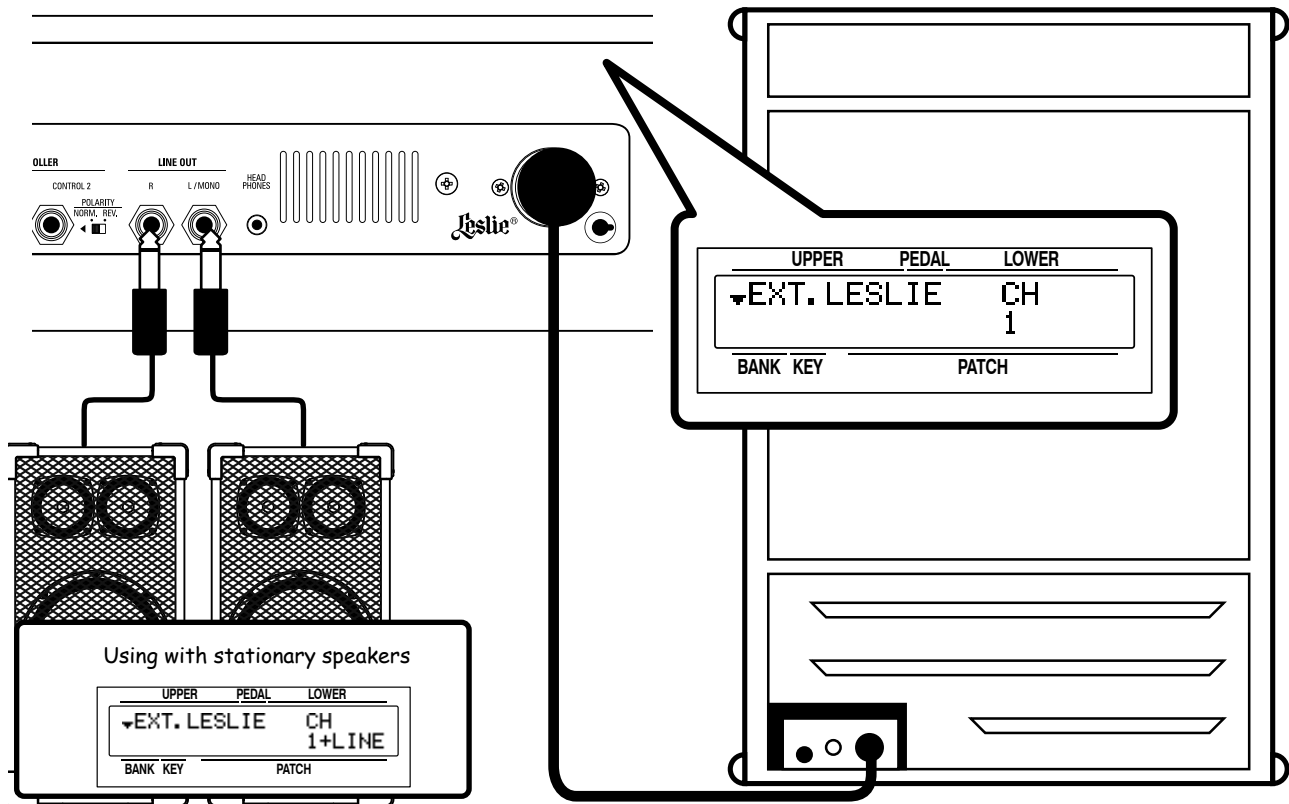

Hook-Up

BASIC CONNECTION OF THE LESLIE SPEAKER

Connect the Leslie Speaker #981/#3300/#122XB and the Leslie 11-PIN jack on this keyboard with the exclusive 11-pin Leslie cable (not included).

1. Set the LESLIE - EXT. LESLIE CH at "1" (P. 88).
2. Switch "OFF" the [BYPASS] button, set the [VOLUME] of the #981/#3300/#122XB at desired volume.

USING WITH STATIONARY SPEAKERS

You can create the sound of a Multi-Channel Leslie Speaker System by sending the "dry" sound through Stationary speakers connected to the LINE OUT Jacks.

1. Set the LESLIE - EXT. LESLIE CH at "1+LINE" (P. 88).
2. Switch "OFF" the [BYPASS] button, set the [VOLUME] of the #981/#3300/#122XB at desired volume.
3. Set the [VOLUME] of the stationary speakers at same volume between Leslie and stationary speakers which you can hear with repeating "ON/OFF" the [BYPASS] button with playing the keyboard.

NOTE: To hear the Digital Leslie by stationary speakers with using real Leslie Speaker, set the EXT. LESLIE CH at "1".

tips STATIONARY SPEAKER

The word "Stationary Speaker" means ordinary no rotating speaker. It is pair of words "Rotary Speaker".

This keyboard can use genuine stationary speakers #2121, or some keyboard amplifiers which commercially available.

EXPAND THE KEYBOARD

This instrument can be upgraded to dual keyboards by connecting an external keyboard and pedalboard.

3 KEYBOARDS (USING XLK-5 AND XPK-250W)

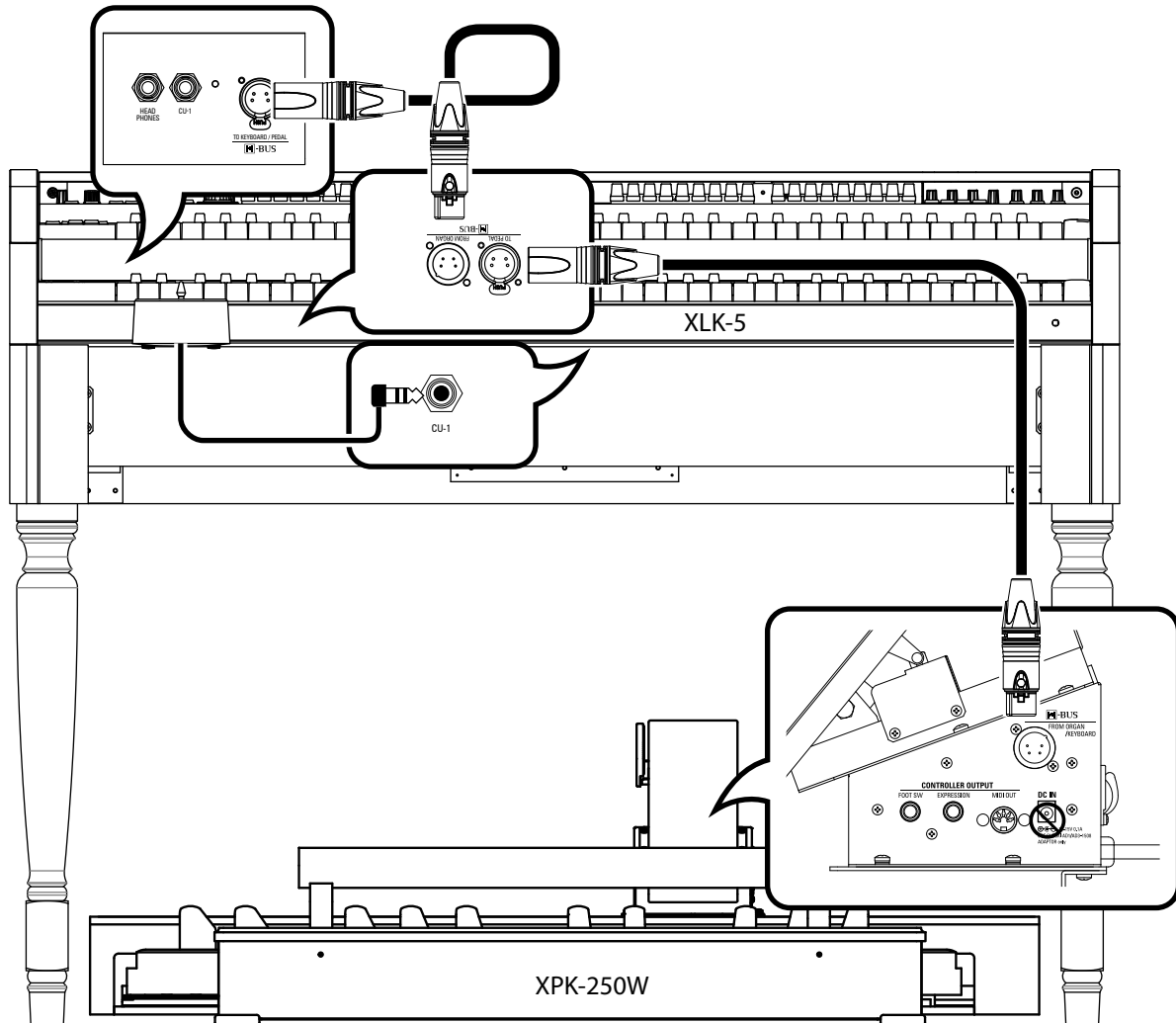

1. Hook-up as illustrated above.

NOTE: This illustration shows only the keyboard expansion. See P. 16 for the basic hook up of the power source, audio, etc.

2. Switch on this keyboard.

Refer to the operation manual of the XLK-5 and XPK-250W, as required.

3 KEYBOARDS (USING MIDI KEYBOARDS)

Hook-Up

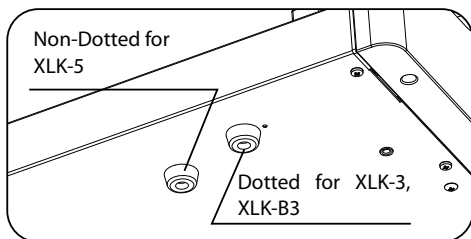
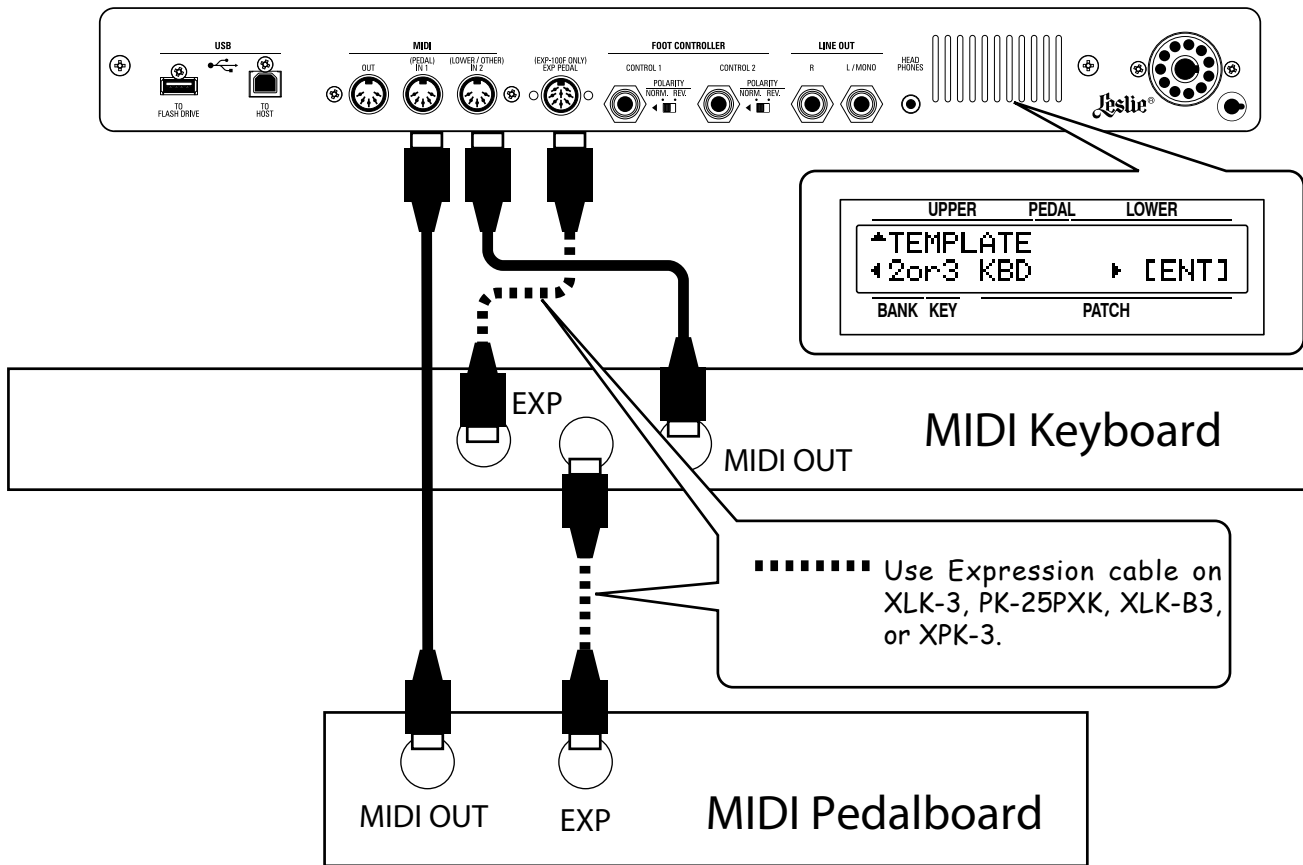

To place this unit correctly, move the rubber feet to match the MIDI keyboard (Lower Keyboard). Use a Phillips screwdriver #2 to move the rubber feet.

1. Hook-up as illustrated above.

NOTE: This illustration shows only the keyboard expansion See P. 16 for the basic hook up of the power source, audio, etc.

2. Switch on this keyboard, and recall the MIDI TEMPLATE “2or3 KBD” (P. 128 #1). Connected MIDI keyboards works as Lower and Pedal parts. If you wish to use the MIDI keyboard as Upper and This keyboard as Lower, set the MIDI IN mode at “UPPER” (P. 128 #2).

Refer to the operation manual of the MIDI keyboards, as required.

◆ RECOMMENDABLE MIDI KEYBOARD

The following HAMMOND MIDI keyboards (compliant with the XK-5) are available from our sales dealers:

- ◆ Lower keyboard unit XLK-3, XLK-B3
- ◆ MIDI pedalboard XPK-130G (13 keys)
- ◆ MIDI pedalboard XPK-200G (20 keys), XPK-200GL (20 long keys)
- ◆ XPK-100, -200, -200L also can be used.

tips HOW WORKS OF MIDI KEYBOARD?

If a MIDI template which except “Basic” such as “2or3 KBD” has recalled, connected MIDI keyboard works as “local” keyboard of this system. All the performance sent from MIDI OUT of this keyboard.

2 MANUALS (WITH XLK-5)

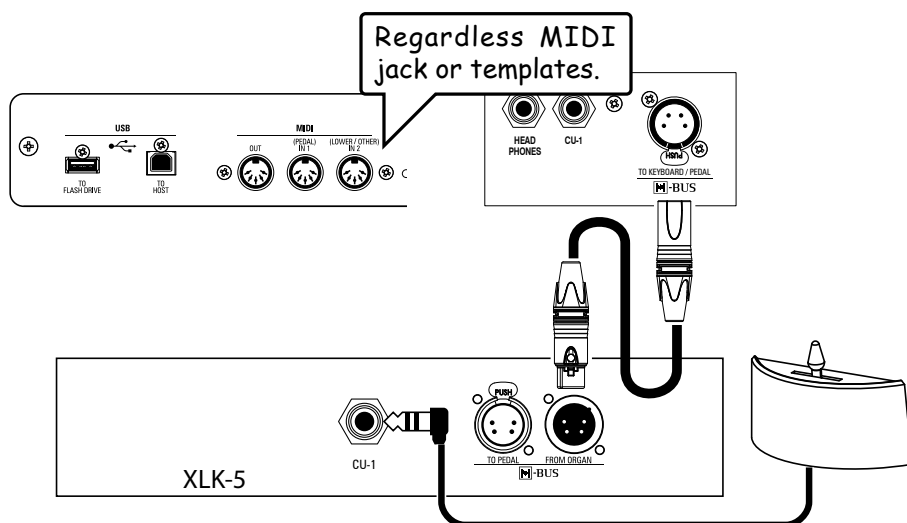

1. Hook up illustrated as above.

NOTE: This illustration shows only the keyboard expansion See P. 16 for the basic hook up of the power source, audio, etc.

2. Switch on this keyboard.

Refer to the operation manual of the XLK-5 as required.

2 MANUALS (WITH MIDI KEYBOARD)

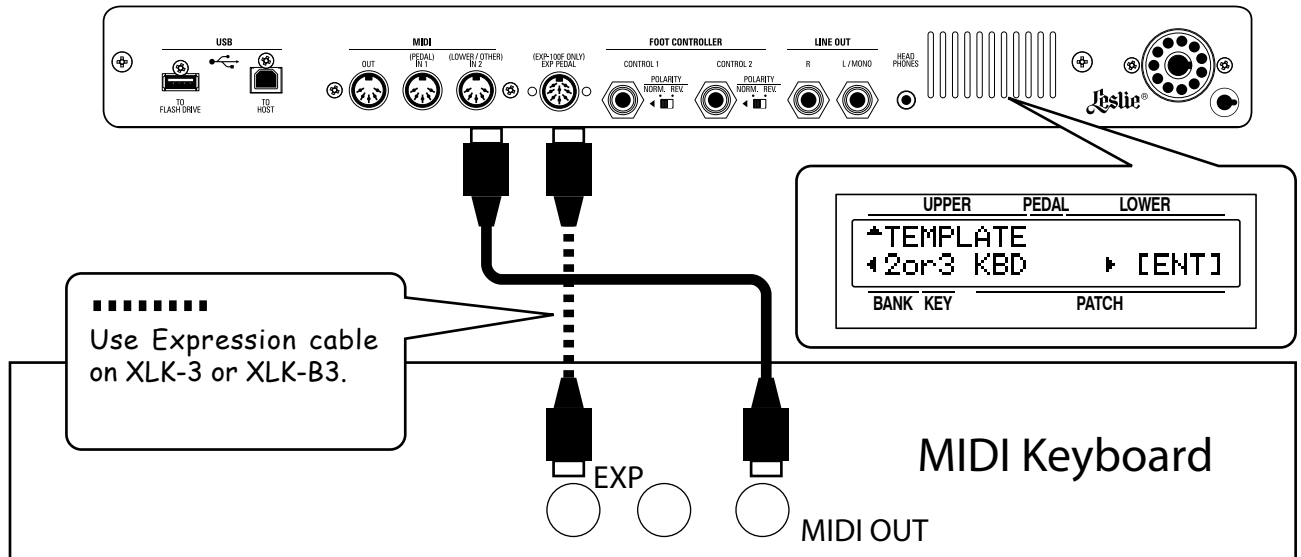

1. Hook-up as illustrated above.

NOTE: This illustration shows only the keyboard expansion See P. 16 for the basic hook up of the power source, audio, etc.

2. Switch on this keyboard, and recall the MIDI TEMPLATE “2or3 KBD” (P. 128 #1). Connected MIDI keyboards works as Lower and Pedal parts. If you wish to use the MIDI keyboard as Upper and This keyboard as Lower, set the MIDI IN mode at “UPPER” (P. 128 #2).

Refer to the operation manual of the MIDI keyboards, as required.

1 MANUAL + PEDALBOARD (WITH MIDI PEDALBOARD)

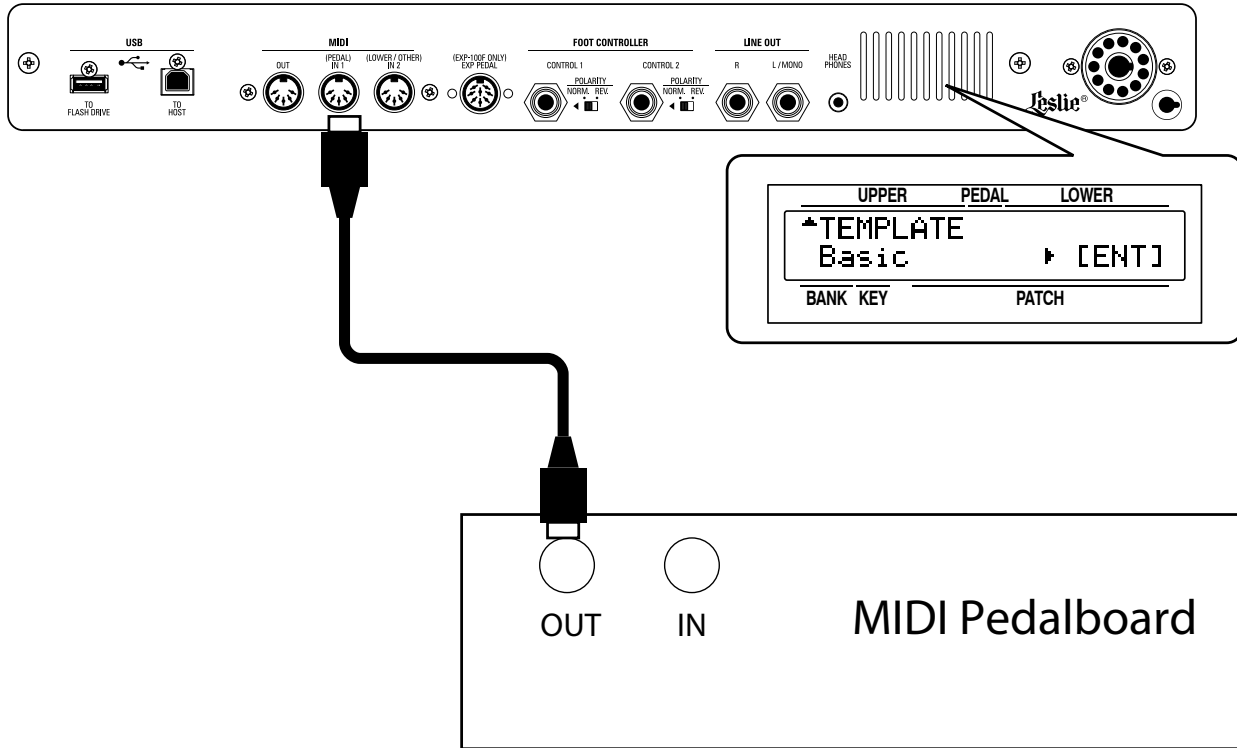

1. Hook-up as illustrated above.

NOTE: This illustration shows only the keyboard expansion See P. 16 for the basic hook up of the power source, audio, etc.

2. Switch on this keyboard, and recall the MIDI TEMPLATE “Basic” (P. 128 #1). Refer to the operation manual of the MIDI keyboards, as required.

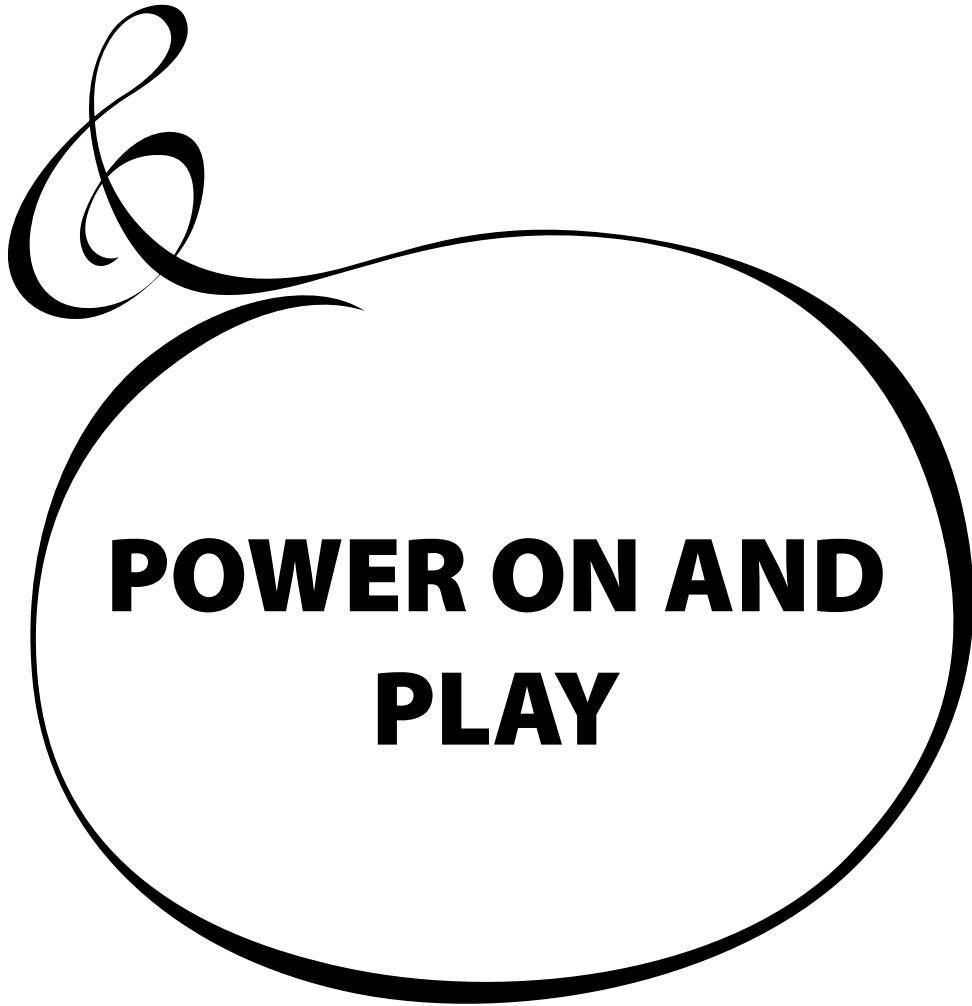

**POWER ON AND
PLAY**

HOW TO POWER ON

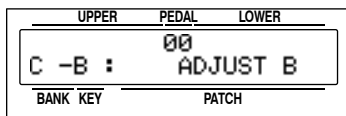
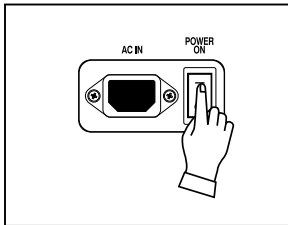
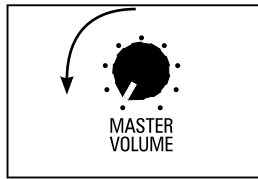

After making the necessary connections, follow the procedures below for powering on your XK-5. Please be sure to adhere to the procedure, to prevent malfunction or damage.

◆ PROCEDURES

1. Before switching the power ON, set the [MASTER VOLUME] knob to minimum.

NOTE: Hook up the foot controllers before power on, and do not press. This keyboard detects foot controller polarity upon power on.

2. Switch ON the [POWER] (on the rear of this keyboard). The Title mode and then the Play mode are displayed (as illustrated).

NOTE: For protecting the circuits, the keyboard is designed not to play immediately at the power on (about 6 seconds).

3. Switch ON the connected amplifier etc. The Leslie speaker switches on automatically.
4. Touch [a Preset Key] - use any Preset Key from "C#" through "A."
5. Holding down a key, adjust the [MASTER VOLUME] (and [EXT. LESLIE VOLUME]) by turning each knob.

NOTE: The "C", "A" and "B" Preset Keys normally do not produce sound when the keyboard is first turned "ON" and no Drawbars are out. Pull out the Drawbars, or press either of the "C#" - "A" Preset Keys to start.

6. Adjust the volume of the amplifiers etc.

NOTE: Reverse the above steps when you switch the power "OFF." Also, be sure to switch the power to a connected amplifier "OFF" before switching the keyboard "OFF."

BACK UP

This keyboard "remembers" the unit's status immediately before the power is turned off, returning the unit to that status upon the next power-on.

The status of the default settings are the same as when the [B] Preset key is depressed.

AUTO POWER OFF

The power automatically turns off if this keyboard is not operated for a certain period of time. (The default setting is 30 minutes.)

To cancel/set the AUTO POWER OFF function, see "SYSTEM" P. 113.

NOTE: Depending on the status of this unit, while editing, for example, the power may not turn off, even if the set time of AUTO POWER OFF elapses. So make sure to turn the "POWER" switch OFF manually, after every use.

RESET TO THE FACTORY SETTINGS

To reset all parameters of this keyboard to its default settings, perform the following steps:

◆ OPERATION PROCEDURES

1. Switch the [POWER] of this keyboard off.
2. Switch the [POWER] ON while holding the [RECORD] button.
3. Keep the button depressed until "Loading Default..." is displayed.
4. When the Play mode is displayed, this operation is completed.

Recall the 200 “PATCHES” recorded in this unit using the VALUE knob and then play.

WHAT IS “PATCH”?

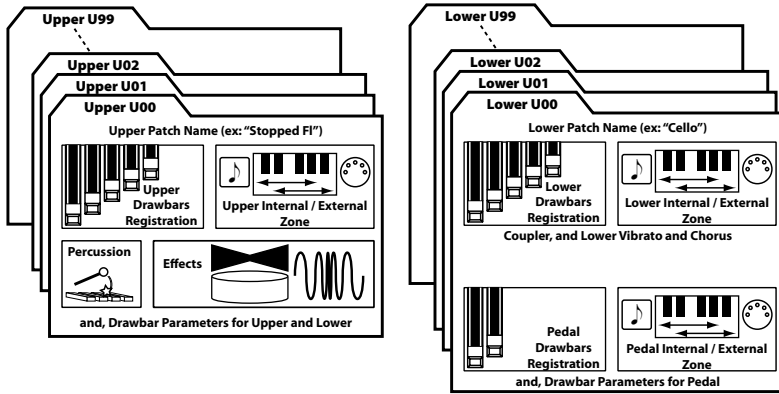

The Hammond XK-5 has, in addition to Drawbar settings, many ways to customize and tailor those settings. In the organ world, this mixing, blending and tailoring of sounds is called Registration. In the keyboard and synth world, a sound or group of sounds and effects is called a Patch. This term derives from old-style synthesizers which used patch cords to connect the various components together to produce sounds. Although modern technology has rendered this technique unnecessary, the term “Patch” has remained.

Each time a Patch is selected it will register a particular setting of the sounds and controls on the instrument. This keyboard has 100 “USER” Patches which are over-writable and 100 fixed “FACTORY” Patches. You can instantly recall them and play.

Power On and Play

HOW TO RECALL A PATCH

◆ ex: Recall the U41

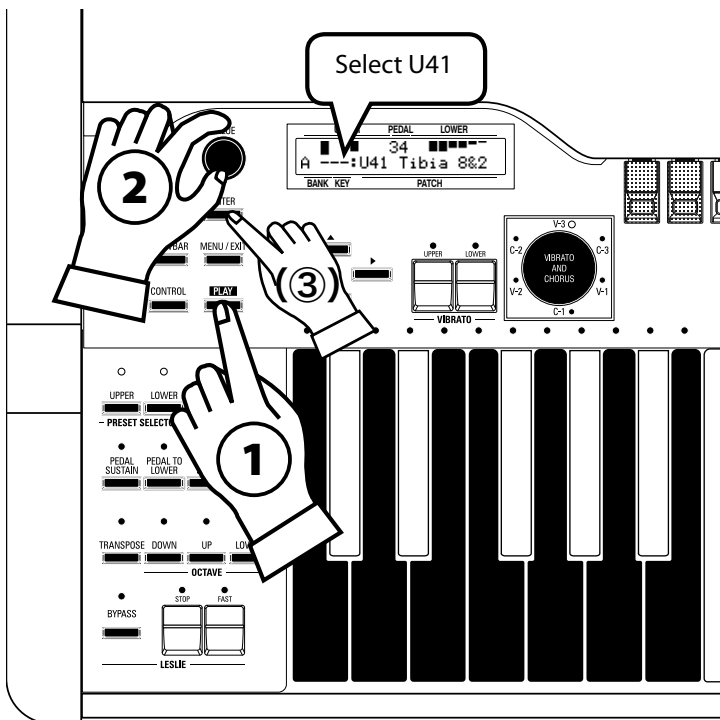

1 Locate the PLAY mode

If the display is not the play mode, locate the play mode by pressing [PLAY] button.

2 Select a Patch

Select the Patch number U41 by [VALUE] knob. Please see “Factory Patches” of appendix for details (P. 149).

If you recall a Patch, this keyboard recalls not only Drawbar registration but also effects such as Leslie or reverb.

3 (Press ENTER to decision)

If the Patch number U41 is blinking on and off, press the [ENTER] button to decide. To cancel the recall, press the [PLAY] or [MENU/EXIT] button.

NOTE: You can set the Patch is recalled by [VALUE] knob instantly, or press [ENTER] button to decision (P. 76).

If you recall a Patch, this keyboard recalls not only Drawbar registration but also effects such as Leslie or reverb.

NOTE: You can set that assignment the Patch number to any Preset keys, and recall it immediately (P. 29).

PLAY WITH PRESET KEYS

Play with “Patches” which assigned on the Preset Keys.

WHAT ARE “PRESET KEYS”?

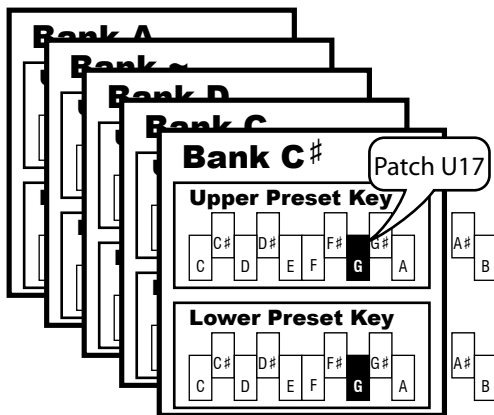

The Preset Keys are the key group which select the Patches (various setting) quickly, a Preset Key assigned a Patch.

NOTE: It explained on “Favorites” (P.29) relation between “Preset Key” and “Patch”.

There are 10 “Banks” of Preset Keys. In this manual, “C#-G” means [Bank C#]-[Key G].

NOTE: This keyboard has only one manual keyboard, you can select separate Preset Key at each part, Upper and Lower like the B-3/C-3. The word “Part” explained at “Try to make your own sound” (P.34).

Recall the “C#-G” as shown as left figure.

RECALL BY PRESET KEYS

◆ ex: Recall C#-G

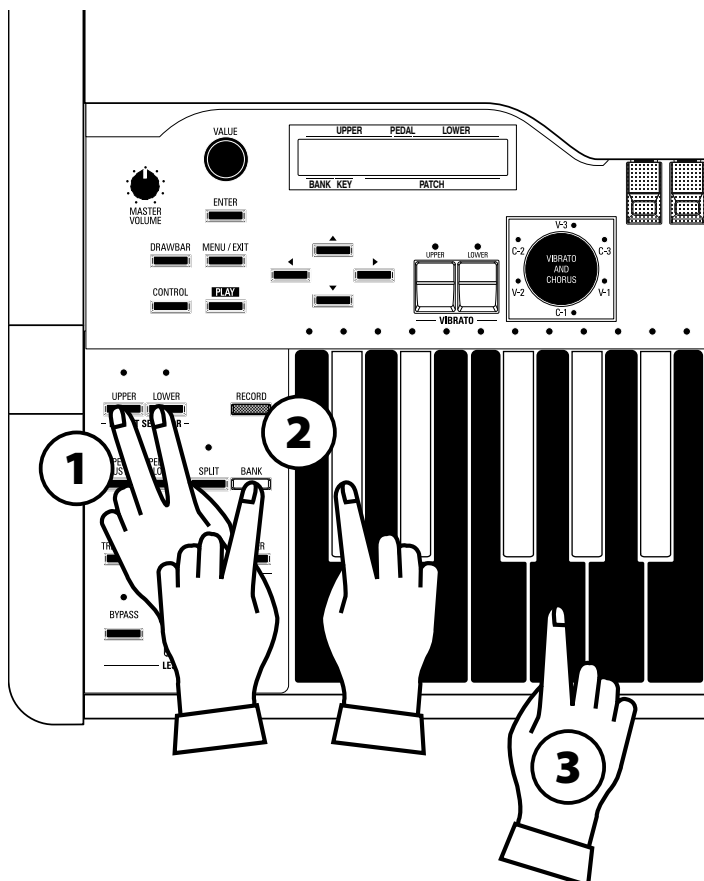

① Select parts which you wish to recall

Press the both [UPPER] and [LOWER] of the PRESET SELECTOR to “ON”. This recall the patches for both parts.

② Select the BANK

While holding down the [BANK] button, press the “C#” Preset Key.

NOTE: The LED for the Preset Key indicates the “BANK”, while the [BANK] button is touched.

③ Select the KEY

Press the “G” Preset Key.

At this time the Preset is selected and the setting changes.

NOTE: While the [BANK] button is released, the red LED indicates the “KEY” for UPPER, green LED indicates “KEY” for LOWER.

Try calling various Presets.

If you recall a Patch, this keyboard recalls not only Drawbar registration but also effects such as Leslie or reverb. On the Bank [A] at factory setting, it recalls only Drawbar registration which same as B-3/C-3.

NOTE: The part which recalled a Preset is select by PRESET SELECTOR.

NOTE: You can set the parameters to recall (P.76).

NOTE: Sound will interrupt on some Preset are recalled.

Patches are selected with the [VALUE] knob. On stage, it is convenient to have your favorite patches available immediately. Here's how:

WHAT IS "FAVORITE" ?

When Favorite is "OFF"

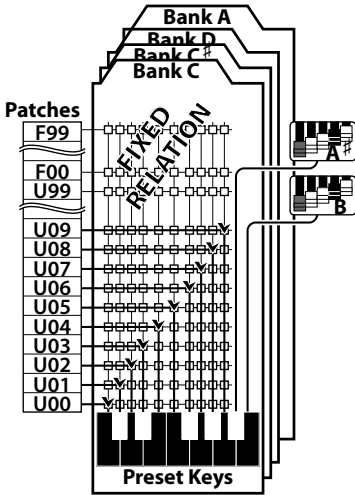

To record a Patch:
[BANK] + Preset Key,
[RECORD] + Preset Key

To assign a Favorite:
None

When Favorite is "ON"

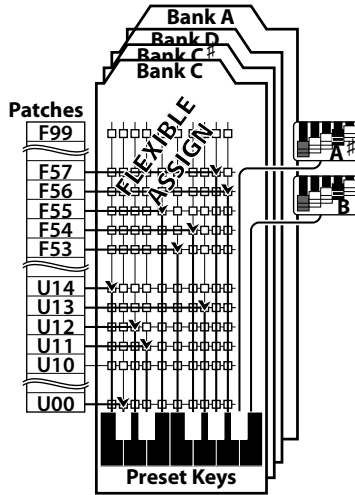

To record a Patch:
Press [RECORD],
Select Patch# by [VALUE],
and Press [ENTER]

To assign a Favorite:
Select a Patch by [VALUE],
[BANK] + Preset Key,
[RECORD] + Preset Key

"Favorite" is a function that allows to make flexible assignment between Preset key and Patches as shown as figure right.

Recalling the Patch that you experienced on the previous page, in fact, it recalled a favorite table that "fixed" between Preset keys and Patches (figure left).

Power On and Play

THE FAVORITE FUNCTION

The function around Preset Keys will changed with "On" and "Off" of the Favorites.

◆ Favorites is "Off"

- ◆ The Preset Keys of this keyboard works as they do on recent Hammond organs.
- ◆ The Preset Keys "C-C" to "A-A" corresponding patches "U00" to "U99" respectively.
- ◆ To record a Patch (with selecting the Bank), press the any Preset Key with holding the [BANK] button, and press any Preset Key with holding the [RECORD] button.

◆ Favorites is "On"

- ◆ The Preset Keys of this keyboard recalls Patches regarding Favorite table.
- ◆ To record a Patch, press the [RECORD] button, select the Patch number to record by [VALUE] knob, and press the [ENTER] button to decide.
- ◆ The operation "[RECORD] + a Preset Key" only records the Patch to the chosen Preset key. It does NOT overwrite the Patch itself.

tips CANCEL

The Preset Key [C] also called "Cancel". It mutes the sounds on the B-3/C-3. You can record in the Preset Key [C] on the XK-5, but it makes no sounds when you select this Preset Key at the factory setting.

tips ADJUST PRESET

The Preset Keys [B] and [A#] also called "adjust preset". It makes all the current control panel settings active, allowing for real-time registration, and the creation of new patches.

SWITCHING FAVORITE ON AND OFF

① LOCATE THE MENU MODE

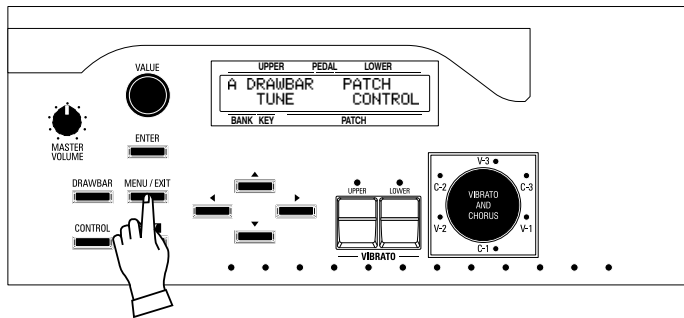

Press the [MENU/EXIT] to display the menu. If the display shown does not match the illustration, press it again.

② SELECT "PATCH"

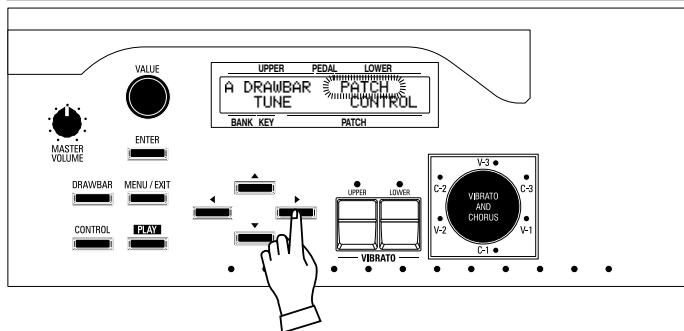

Press the [▶] button to select PATCH.

③ ENTER THE PATCH FUNCTION PAGE

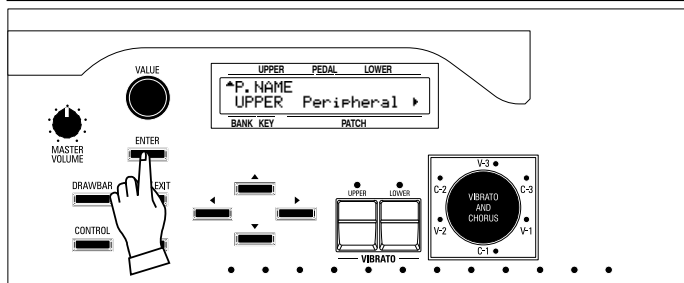

Press the [ENTER] button. The PATCH function page is displayed.

④ LOCATE THE PRESET KEY PAGE

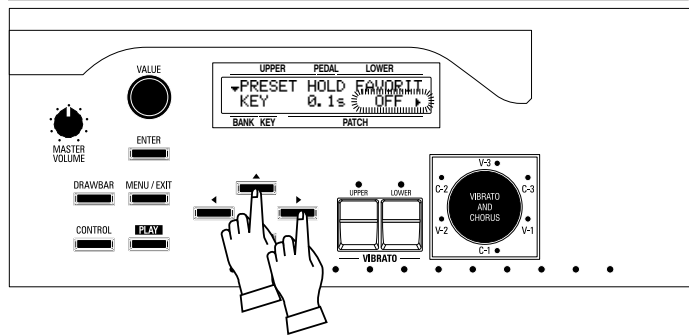

Press the [▲] button 4 times, and [▶] button once. The value of FAVORIT(E) blinks.

⑤ CHANGE THE VALUE

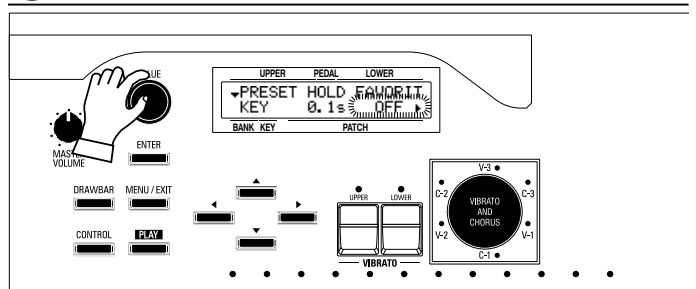

Select "ON" or "OFF" by [VALUE] knob.

⑥ BACK TO THE PLAY MODE

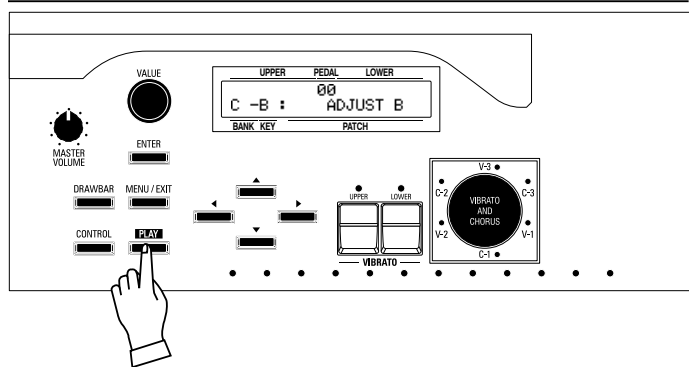

Press the [PLAY] button to back to the Play mode.

ASSIGN A PATCH TO A PRESET KEY

Assignment Patches to the 100 Preset Bank/Key (“C-C” to “A-A”, except A# and B) regarding your playlist or changing scene in the song.

1 SWITCH ON THE FAVORITE

Switch the Favorite “On” refer to the previous page.

2 SELECT A PATCH

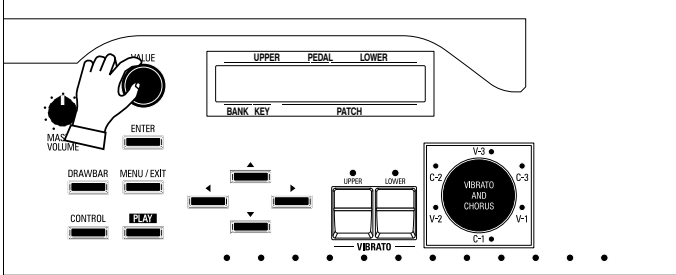

Select a Patch which you wish to assign to a Preset Key refer to the “Play with the Patches” (P. 27).

3 SELECT A BANK/KEY TO ASSIGN

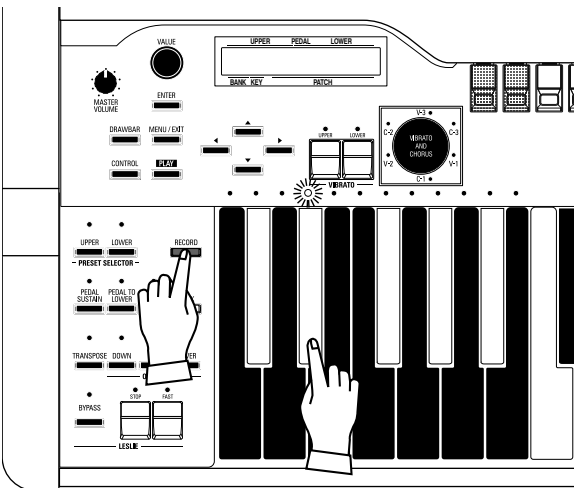

Press the Preset Key with holding [BANK] button to assign Bank, press the Preset Key with holding [RECORD] button to assign Key.

The display shows below a while, and the LED blinks fast a while too.

Recording Favorite..

NOTE: You can assign the Favorites by using menu function (P. 77).

USING CONTROLLERS

Your performance will be more expressive, if you play on the manual using the controllers. You will see on this page how to use the controllers generally used with the electronic musical instruments. (How to use the exclusive Hammond Organ controllers is shown on the next page.)

EXPRESSION PEDAL

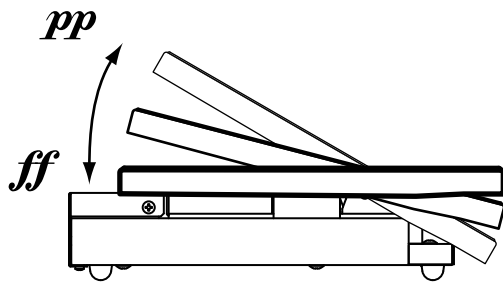

EXP-50 (optional)

The Expression Pedal controls the overall volume or loudness of the XK-5. The further you depress the pedal, the louder the sound becomes; the more you pull back on the pedal, the softer it.

NOTE: The Expression pedal has specific parameters to adjust. (P. 79)

FOOT SWITCH

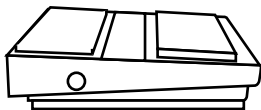

FS-9H (optional)

The Foot Switch controls the various switching operation. For example, the Leslie effect switches fast or not by every step by "Leslie S/F Alternate", holding note with pressing by "Damper", etc.

NOTE: You can change the foot switch assignment. (P. 78)

LESLIE MODE SWITCH

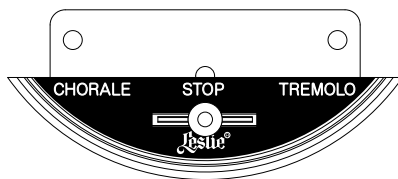

CU-1 (optional)

The Leslie Mode Switch switches the slow, stop and fast the modes of the Leslie effect.

This switch is high durability, for players who switching frequently while playing.

NOTE: Also, there is called "Main Echo Switch" in the Leslie switches. It is unsupported in this keyboard.

Simply called "Leslie Switch", generally indicates this Leslie Mode Switch.

tips ANOTHER NAMES OF THE LESLIE MODES

Hammond Organs has long time of history and used in various culture. Sometimes a function name called different name. On the Leslie effect;

"Slow" also called "Chorale" which reminds slowly beating by unison choir,

"Fast" also called "Tremolo" by fast modulation, and

"Stop" also called "Brake".

TEMPORARY EQUALIZING (MASTER EQUALIZER) 33

Every room has a different acoustic profile, and it is often necessary to compensate for this. The XK-5's Master Equalizer allows you to tailor the overall tonal profile of your instrument without changing the contents of the Patches.

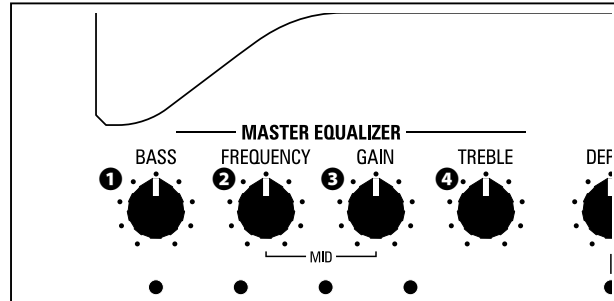

1 BASS

Adjusts the Boost/Cut of Bass.

The setting range is -9 to +9. It is flat at center.

2 MID FREQUENCY

Adjusts the center frequency (Middle) to be attenuated.

The setting range is 250Hz - 3.1kHz.

3 MID GAIN

Adjusts the Boost/Cut of Middle.

The setting range is -9 to +9. It is flat at center.

4 TREBLE

Adjusts the Boost/Cut of Treble.

The setting range is -9 to +9. It is flat at center.

NOTE: The sound may distort if gains are raised too high. Adjust accordingly.

NOTE: These are live performance controls, and they are not record to Patch memory.

NOTE: You can change the corner frequency of BASS and TREBLE(P. 110)

TRY TO MAKE YOUR OWN SOUND

In this section you'll learn how to create your own sound. In this example, a Classic Jazz Organ.

SELECT [B] PRESET KEY

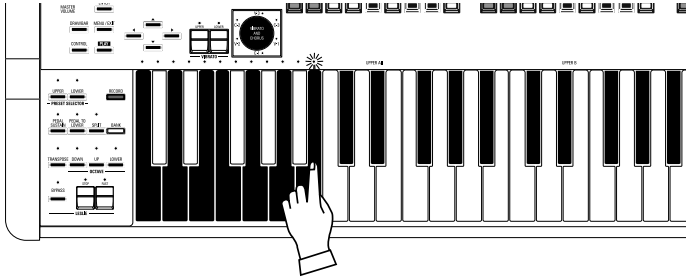

First, select the [B] Preset Key (LED lit).

The Preset Keys [B] and [A#] also called “adjust preset”. It makes all the current control panel settings active, allowing for real-time registration, and the creation of new patches.

Column: Initializing Adjust Presets

When the [A#] and [B] Preset Keys are pressed, not only do the current panel settings become active, but the internal settings do as well. This is the procedure to return them to the DEFAULT Status.

1 LOCATE THE MENU MODE

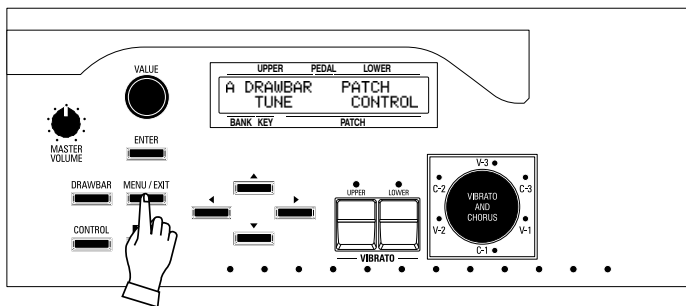

Press the [MENU/EXIT] button to Menu mode appears. If the display is different from the above illustration, press the [MENU/EXIT] button again.

2 GO TO PAGE F

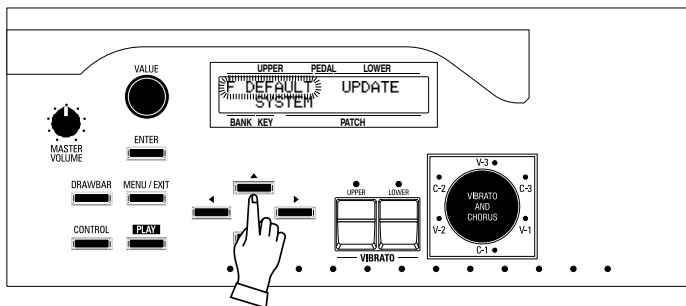

Go to the page F by pressing [▲] button at 5 times. The item DEFAULT will be selected.

3 ENTER THE FUNCTION MODE

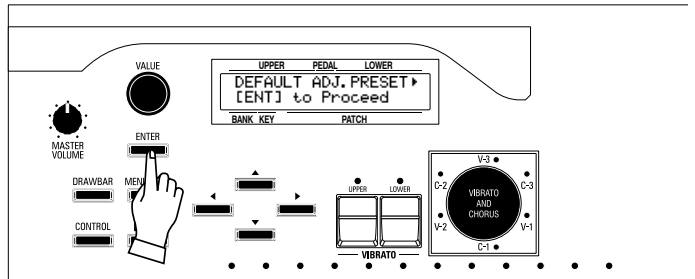

Press the [ENTER] button. This brings up the ADJ. PRESET page of the DEFAULT function mode.

4 ENTER AGAIN

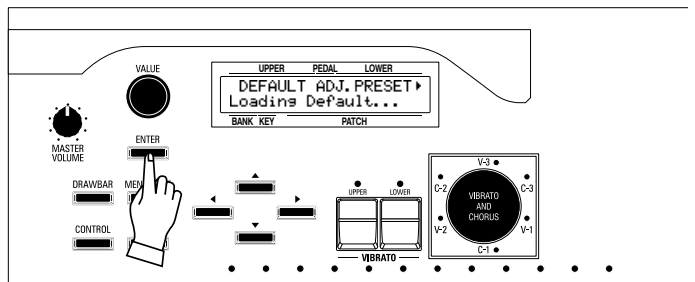

Press the [ENTER] button. The contents of [A#] [B] are initialized.

5 RETURN TO THE PLAY MODE

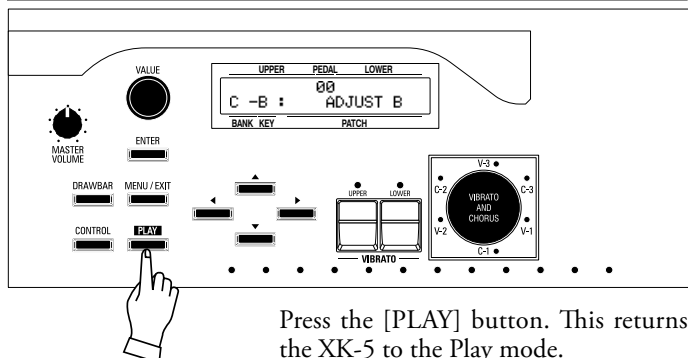

Press the [PLAY] button. This returns the XK-5 to the Play mode.

PULL OUT THE “B” DRAWBARS

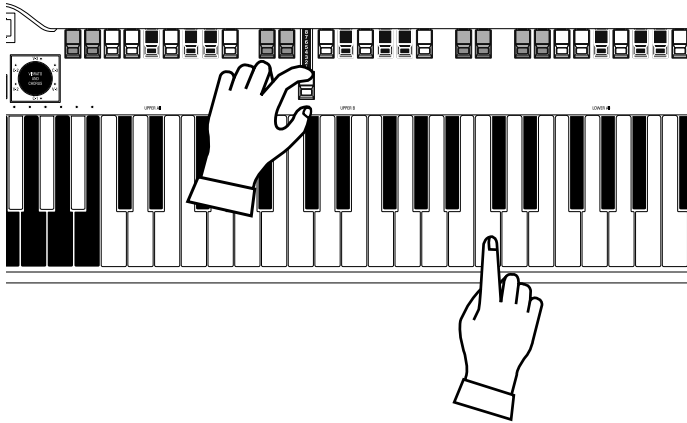

Pull out “B” Drawbars on the second group from the lowest note to your taste. You can monitor your selections easily while playing the keyboard (the UPPER keyboard if keyboards are extended).

The Drawbars make the fundamental organ sound of this keyboard. The tone changes in relation to how far the Drawbars are “pulled”.

The volume of each sound is greatest when the Drawbar is pulled out all the way, and null when fully pushed back. The Drawbars are arranged so that the pitches grow higher from left to right.

For this example, pull the 16’, 5 1/3’ and 8’ Drawbars to “8” (all the way out).

NOTE: You can change the sound character of the Drawbars. (P. 74)

NOTE: The present registration is displayed in the Play mode. (P. 65)

ADD THE TOUCH-RESPONSE PERCUSSION

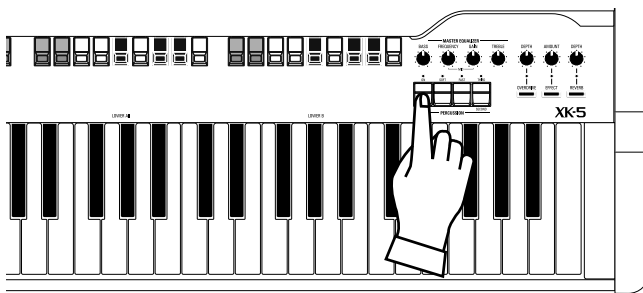

Hammond’s Touch-Response Percussion adds a distinctive attack to the Tone Wheel/Drawbar sounds. This Percussion is not like a drum or cymbal, but closer to an xylophone or marimba. [PERCUSSION] is available only on the UPPER part.

To enable the percussion, turn the [ON] button on.

There are two choices of Percussion Pitch. One sounds an octave above the note played (“Second”), and another sounds a “twelfth” above. (“Third”) - When the [THIRD] light is off “Second” is selected.

The [FAST] button quickens the decay of the Percussion voice and [SOFT] reduces the volume of the Percussion voice.

For this example select all of the Percussion buttons [ON], [THIRD], [FAST], [SOFT].

NOTE: You can fine-tune the percussion parameters to your taste. (P

Column: What is “Part”?

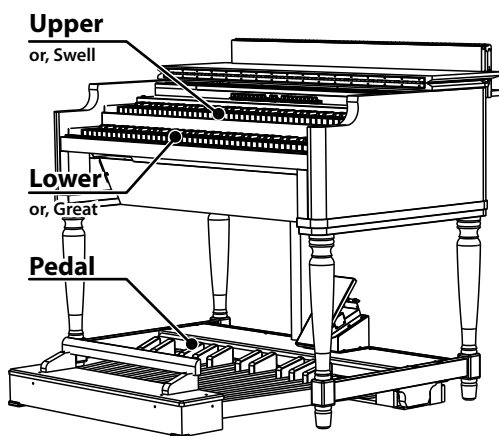

Each “Part” is equivalent to a player in a band or an orchestra. The 3 Parts here are expressed in Organ terms: Upper, Lower, and Pedal. These parts can be individually played with different sounds. The Upper keyboard was called “Swell” came from the pipe organ.

The XK-5 has a single keyboard. Plural parts are available simultaneously, by splitting the keyboards or expanding them using a MIDI keyboard.

The Upper and Lower are also called “Manual”.

tips ANOTHER NAMES OF PARTS

The names for the keyboards on vintage Hammond Organs came from the Pipe Organ. The “Upper” keyboard (manual) was called “Swell” and the “Lower” keyboard (manual) was called “Great”.

ADD EFFECTS

◆ VIBRATO AND CHORUS

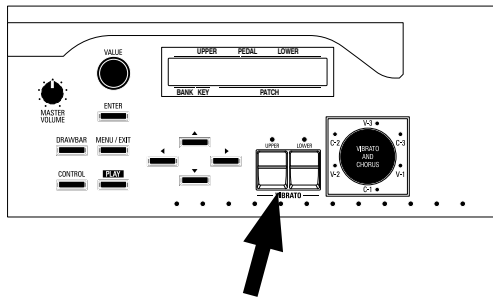

Adding the Classic Hammond Vibrato & Chorus to the sound.

[UPPER], [LOWER] buttons

Switches the Vibrato & Chorus effect ON(LED lit)/OFF.

[VIBRATO AND CHORUS] knob

Select the modes in this effect. The letter “V” means Vibrato, “C” means Chorus by adding dry sound, and the number means width of vibrato.

NOTE: You can fine-tune the speed of Vibrato/Chorus. (P. 85)

For this example, switch “ON” the [UPPER] and select “C-3”.

◆ LESLIE

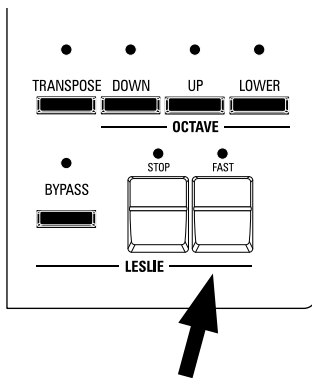

The Leslie effect is the famous “Moving and Swirling” sound provided by rotating horns and speakers, but executed here in the digital realm.

[FAST] button

This button toggles the mode of the rotor to FAST(LED lit) or not.

[STOP] button

This button sets the mode STOP(LED lit) or SLOW when the [FAST] button is off.

[BYPASS] button

To engage the Leslie effect, press the [BYPASS] button turning the light OFF.

NOTE: These controls perform the same functions when a external Leslie speaker is connected via the 11 pin plug.

NOTE: You can fine-tune the parameters of the on-board Leslie effect etc. (P. 86)

For this example, let’s set the status of all Leslie buttons lights to OFF.

◆ OVERDRIVE

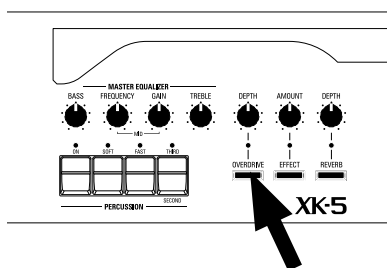

The overdrive section adds warmth at low settings, and “grit” or distortion at higher.

[OVERDRIVE ON] button

This button toggles ON(LED lit)/OFF the Overdrive effect.

[DEPTH] knob

Adjusts the amount of Overdrive. The amount increases as you rotate the knob clockwise.

NOTE: You can fine-adjust the Overdrive effect (P. 101).

◆ MULTI EFFECT

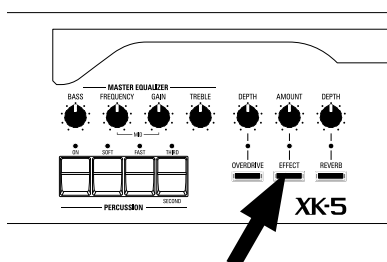

Adjusts the amount of the Chosen Multi-effect to be applied to the Drawbar sounds. The default settings: at “Tremolo”.

[EFFECT ON] button

Toggles the Multi-Effects send ON(LED lit) and OFF.

[AMOUNT] knob

Adjusts the amount of Multi-Effect to be applied. The amount increases as you rotate the knob clockwise.

In this example, the Multi-Effects are not used. The Button light should be OFF.

SPLIT - DIVIDE THE KEYBOARD BY PARTS

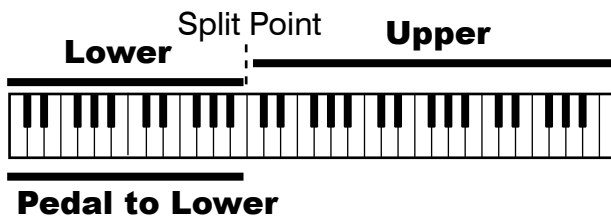
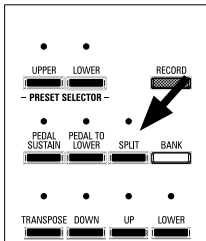

The XK-5 has only 1 manual, but it can be split and will respond as if it were a 2 manual instrument.

[SPLIT] button

To use the Split function, press the [SPLIT] button and the light will go ON. The default setting split is at the middle B/C.

NOTE: You can change the split point (dividing note) and octave. (P. 126)

NOTE: The Split function is disabled when a second keyboard is added. (P. 128)

Right of the split point is referred to as: UPPER and the left side LOWER. Percussion does not function on the LOWER part.

PEDAL TO LOWER - ADD BASS TO PLAYING LOWER

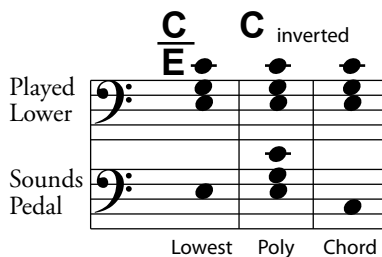
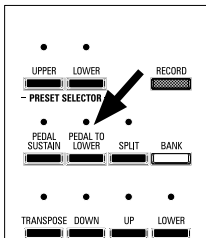

You can play the PEDAL part using the lowest notes of the LOWER keyboard using Pedal To Lower.

[PEDAL TO LOWER] button

To use the Pedal To Lower function, press the [PEDAL TO LOWER] button and the light will go ON. The Pedal/Bass sound is heard in conjunction with the lowest note being played, on the manual keyboard.

The default Pedal To Lower limit point is set to sound up to, and including middle "B".

NOTE: The Pedal To Lower can be set to play in Lowest, Polyphonic, and Chord modes (P. 126 #1). You can change the playing range of the Pedal To Lower (the upper limit) (P. 126 #2).

NOTE: When the XK-5 is expanded to 2 manual, the Pedal To Lower function appears on the physically LOWER keyboard (P. 128).

The Pedal To Lower plays the PEDAL part and its sound is controlled by the [PEDAL] Drawbars.

You can use both the manual bass and the split at the same time. Making it possible to play the bass + chord + melody together.

NOTE: Jazz organists add a distinctive rhythm by "thumping" one or more pedals in time to their playing. You can simulate this technique without having a pedalboard by assigning a pedal note to a foot switch via a CONTROL parameter. See (P. 78).

PEDAL SUSTAIN - SMOOTH DECAY WHEN RELEASE

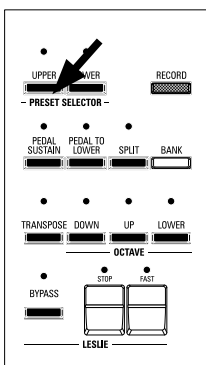

A popular effect for organ bass is "PEDAL SUSTAIN", which adds a smooth decay reminiscent of a string bass.

[PEDAL SUSTAIN]

To engage the pedal sustain, press the [PEDAL SUSTAIN] button and the light will go ON. When you release your foot from the pedalboard (or release the key on the keyboard - when using Pedal To Lower), the PEDAL part decays smoothly.

NOTE: You can adjust the sustain time of the Pedal Sustain. (P. 75)

RECORD THE PATCH TO MEMORY

All the previous settings can be recorded to any Patch within the range of U00 to U99.

◆ Example: RECORD TO U32

① LOCATE THE RECORD MODE

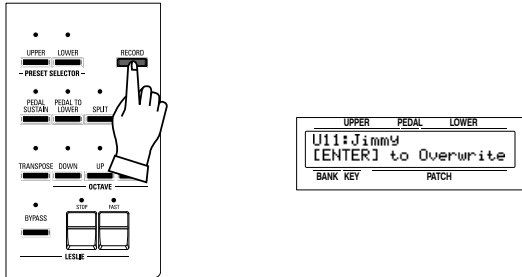

Press the [RECORD] button.

The display basically asks the question “Where do you wish to record it?”

② SELECT THE PATCH NUMBER

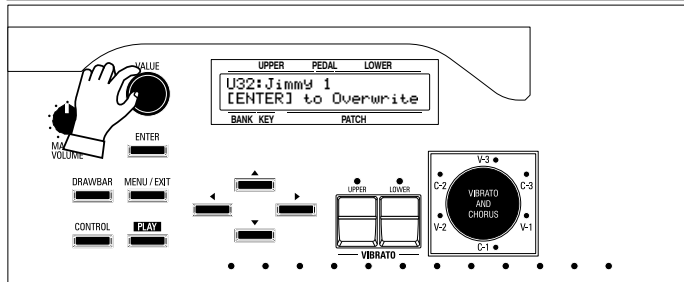

Select the Patch number, this time U32, to record, using the [VALUE] knob.

③ DECIDE

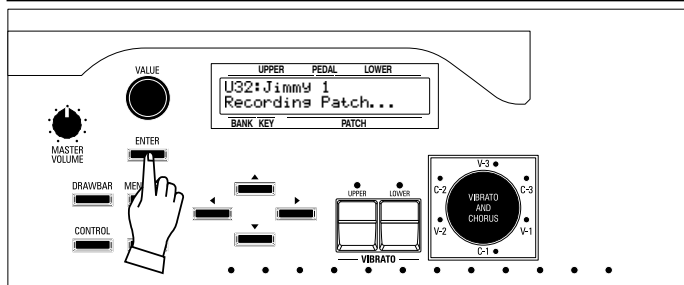

Press the [ENTER] button.

The Patch number is decided and “Recording Patch” is displayed. When the recording process completes, the display returns to the previous mode.

The recorded Patch is automatically selected.

NOTE: User created Patch data is not lost when the power is turned off and/or disconnected.

The Patch can be recorded by using Preset Keys when the Favorite is “Off” (P. 77).

◆ Example: RECORD TO D#-D (U32)

① SELECT BANK

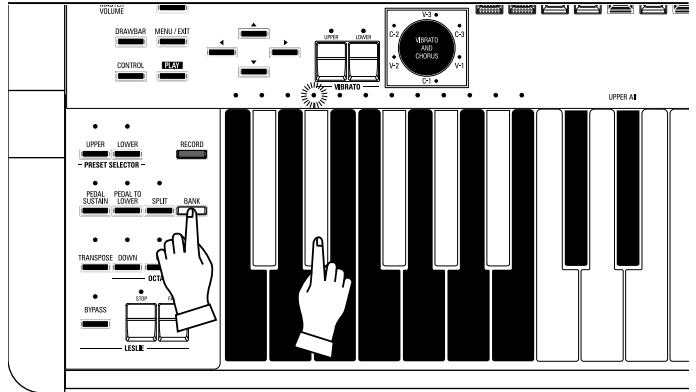

Press the Preset Key [D#] with holding [BANK] button.

The LED on the Preset Keys indicates the Bank while the [BANK] button is pressed.

NOTE: The LED is “Off” when [BANK] button is released. This means undecided Preset Key.

Skip this step if the Bank does not change.

② SELECT KEY

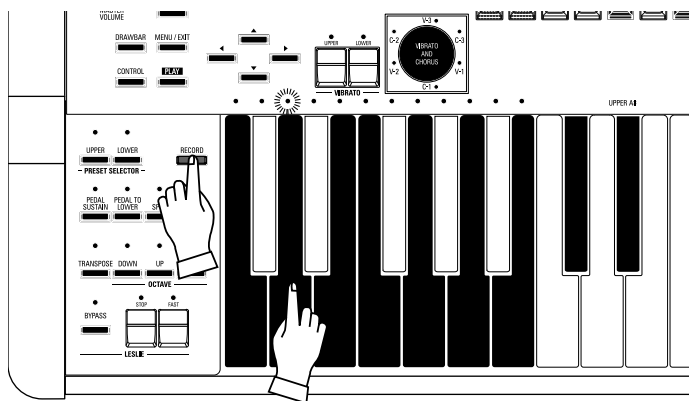

Press the Preset Key [D] with holding [RECORD] button.

The Preset is decided, display shows “Recording Patch”. When the recording process completes, the display returns to the previous mode.

The Preset Keys [A#] and [B] does not need these steps, because these keys memorize latest setting always.

NOTE: User created Patch data is not lost when the power is turned off and/or disconnected.



SOUND ENGINE STRUCTURE

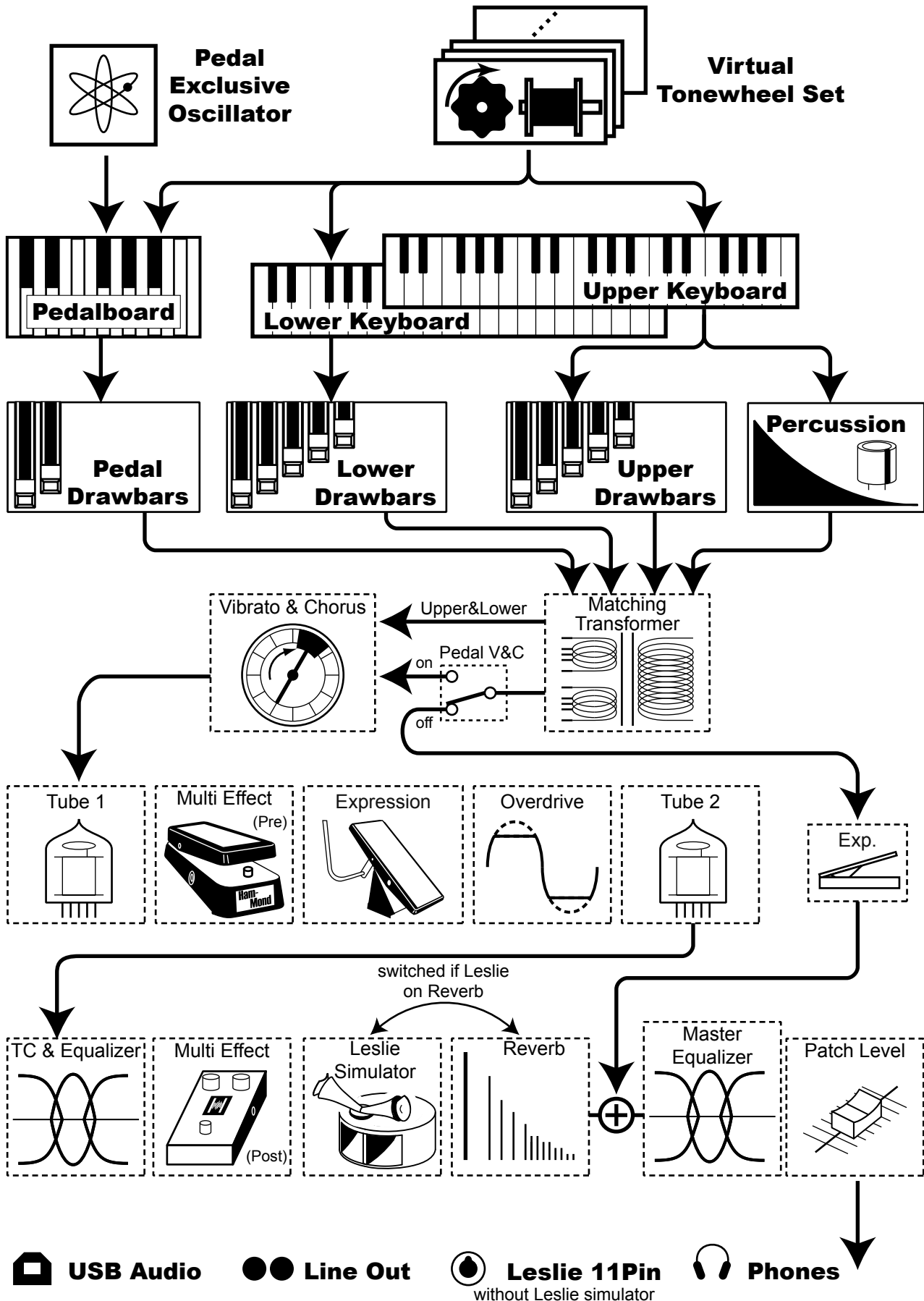

If you want more detail, please read from following this page.

◆ TONE WHEELS

The sound source or “engine” of the classic Hammond Organ are electro-magnetic Tone Wheel generators. On this keyboard, the Tone Wheel engine is replicated digitally.

While the power is on, each of the 96 virtual Tone Wheels keeps oscillating as they did in the vintage Hammond Organs.

◆ KEYS

The tone signals created with the 96 virtual Tone Wheels are “switched” at the keys.

To each key the signals corresponding to the pitch and harmonics (for example, 9 sets on the manual keyboard) are distributed, and when you touch or release a key, the switch connects or cuts the tone signals, in the same manner as a faucet controls water flow.

◆ DRAWBARS

Each Drawbar represents a fundamental harmonic. Each bar adjusts the volume of each harmonic. There are 9 drawbars corresponding to 9 different harmonics.

◆ TOUCH-RESPONSE PERCUSSION

The Percussion creates a distinctive attack on the UPPER part.

◆ MATCHING TRANSFORMER

The matching transformer matches the low impedance of the Tone Wheels and key circuits to the high impedance amplifier input. It serves also, through taps on its primary winding, to establish a series of intensity levels for the Drawbars.

◆ VIBRATO & CHORUS

The Vibrato & Chorus gives depth and richness to the organ sound by slightly varying the pitch (Vibrato), or doubling the voice by mixing the original sound, with a duplicate, slightly detuned one (Chorus).

◆ PRE AMPLIFIER, OVERDRIVE

Pre amplifier is the circuit for amplify the audio signal. But we can make it “overdrive” sound by excessive gain with deliberate.

◆ MULTI-EFFECTS

The Multi-Effects create various effects such as tremolo and Wah.

◆ EQUALIZER, LESLIE, REVERB

Other on-board Effects are as follows: an Equalizer for sculpting the tonal response, a Digital Leslie effect for rotary speaker effects, and Reverb.

(The on-board Leslie effect is disengaged when a external Leslie speaker is connected to the 11-pin terminal.)

◆ MASTER EQUALIZER

The signal is routed through the Master Equalizer. Allowing you to tailor your sound for the provided venue, amp, sound system or recording. The settings are not saved in Patch memory.

tips 96 TONE WHEELS?

Yes, 91 Tone Wheels in the B-3/C-3. There are 96 Virtual Tone Wheels in this keyboard, to extend the fold back point.

tips HARMONICS

Harmonic is a pitch of a different ratio to a certain pitch; for example, the one octave higher C to the middle C. The more Harmonics, the brighter and richer sound is obtained.

tips PEDAL V&C

The pedal part can be “lifted” from the Vibrato and Chorus, and pre amplifier. This is to get a clear bass sound as necessary.

WHAT IS "ORGAN TYPE"?

There are various "Organ" types: the Hammond Tone Wheel organs used in everywhere rock, jazz, and Gospel, the transistor organ frequently heard in pop music of 60's. Classical pipe organ used in classical music or church services. All organs have characteristic sounds.

This keyboard will sound like the types of organ you choose.

◆ TONE WHEELS (A-100, B-3, C-3, Mellow)

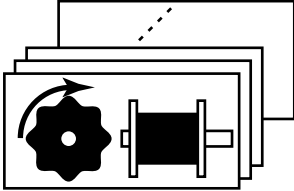

These are various types of Hammond Organs' characteristic Tone Wheels. The Hammond Organ's original purpose was to duplicate the pipe organ, however, they became famous for producing a unique sound of their own.

The "A-100", "B-3" and "C-3" have the B-3/C-3's traditional Tone Wheel sounds.

The "Mellow" is not a Tone Wheel, if strictly speaking. It replicates the first-generation non-mechanical transistor Hammond tone generators like the GT-7 and Concord.

◆ TRANSISTOR (Vx, Farf)

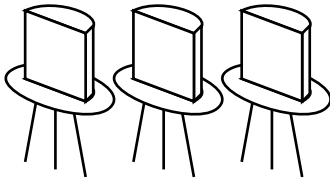

After the transistor became generally used, the light weight organs were introduced (such as Ace Tone TOP-6 etc.) using the transistor circuit instead of the Tone Wheels or tubes. The circuit system is different from maker to maker or model by model. We have replicated 2 representative types here.

The Vx is a type to combine the triangle wave and square wave with several footages. The Farf is one to combine the sound wave forms coming through plural filters with the tablet switch.

◆ PIPE

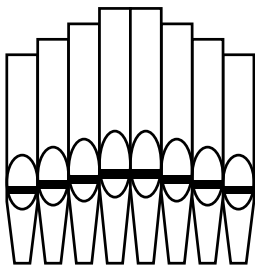

The Church/Classical Pipe Organ uses thousands of individual pipes driven by wind from a blower to create its sound. The name of the stops tells you which wind instrument is duplicated.

You can create other sounds by combining different organ Stops, in the same way Drawbars are used on this keyboard.

tips B-3 AND C-3

"C-3" reproduces C-3 C155596, and "B-3" reproduces B-3 A27563.

The "B-3" has more flutter than "C-3" slightly.

tips TRANSISTOR

The word "transistor" is a coinage of "transfer" and "register". This semi-conductor which invented by William Shockley Jr. in 1947.

The transistor is smaller, operates with lower voltage, and more reliable than the vacuum tube. The electronic circuits has exchanged from vacuum tube to transistor gradually.

tips ORGAN TYPE AND FEATURE / EFFECTS

The Percussion is disabled when the Organ Type is set at "Vx" or "Farf".

Some feature and effects (listed below) are disabled when the Organ Type is set at "Pipe"

- ◆ Percussion
- ◆ Vibrato & Chorus
- ◆ Tube Pre-Amplifier
- ◆ Matching Transformer
- ◆ Overdrive
- ◆ Tremolo, Wah, Ring Modulator in the Multi Effects
- ◆ Patch Equalizer
- ◆ Leslie

Column: SELECTING THE ORGAN TYPES

Use the control panel for switching the organ types.

◆ Example: Switching the manual part to “Pipe”

①

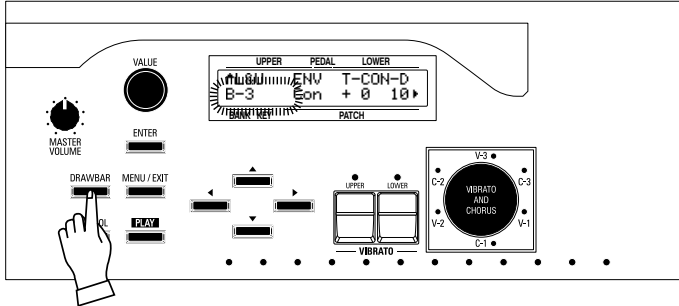

Press the [DRAWBAR] button. The DRAWBAR function mode is displayed and the organ type (“C-3” etc.) of the manual keyboard presently selected blinks.

②

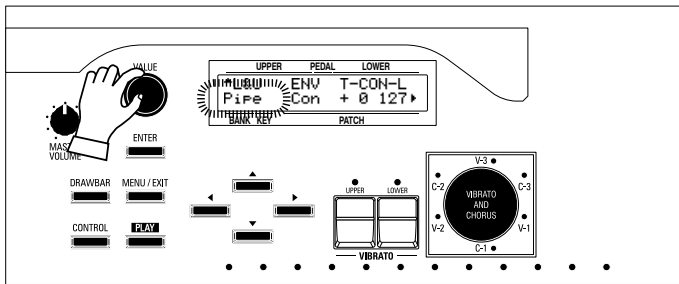

Select “Pipe” with the [VALUE] knob. The pipe organ sounds when you play the keyboard.

③

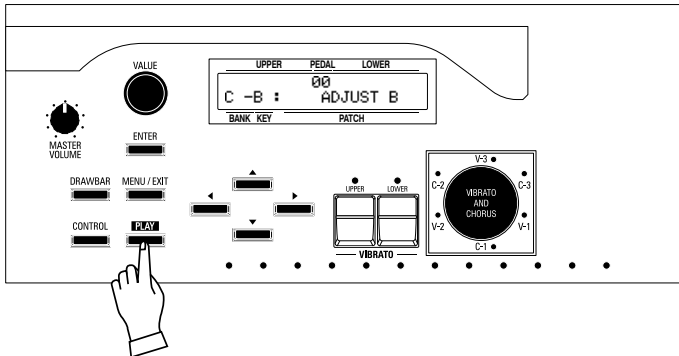

To return to the PLAY mode, press the [PLAY] button.

NOTE: When the Organ Type is switched at “Pipe” of the manual part, it switched at “Pipe” of the Pedal part also automatically.

NOTE: When the Organ Type is switched at “Vx” or “Farf” of the manual part, it switched at “Muted” of the Pedal part automatically.

HARMONIC DRAWBARS™

The Harmonic Drawbars (hereinafter, Drawbars) on this keyboard are used to create the basic “Hammond” sounds. Each Drawbar is marked with the register numbers 1 - 8 along the flat part of the Drawbar. When the Drawbars are fully pushed in, no sound is heard; as the Drawbars are “pulled” the volume of that harmonic increases.

When recalling a patch, the drawbars’ “positions” will change internally, but not physically. When a drawbar is moved, the setting will “snap” to that drawbar’s current position (P. 80).

DRAWBARS (ON TONE WHEEL ORGAN)

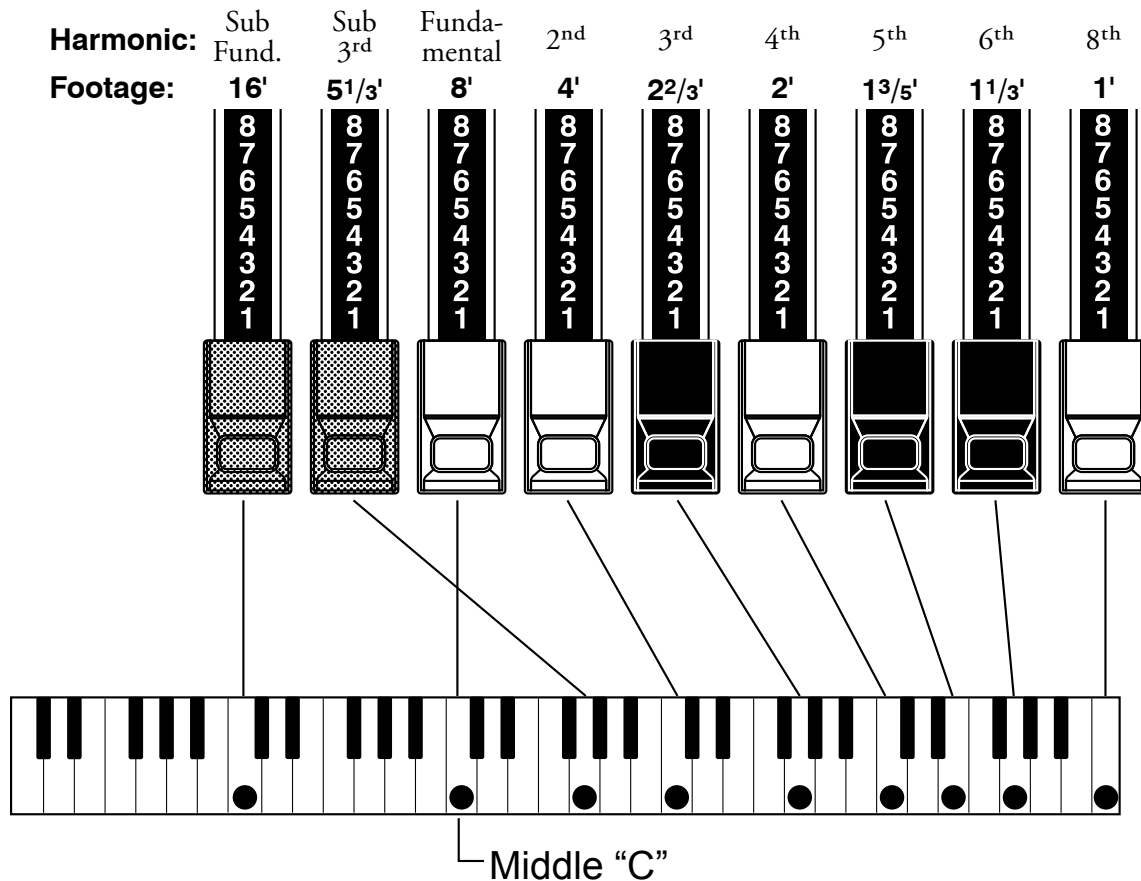

tips DRAWBAR REGISTRATION
The lengths of the pulled out Drawbars.

The pitch of each Drawbar is as shown above, when the middle C is depressed. The footage marked (') legend in front of each Drawbar is derived from the corresponding length of pipes of a pipe organ.

The numbers 1 - 8 on the “bar” portion of each Drawbar indicate the volume of the sound to be produced as well as the guide to remember Drawbar settings.

Pull the fundamental (8'), the third harmonic (2 2/3') plus the fifth harmonic (1 3/5') Drawbars out completely and play the keyboard. Notice how the sound resembles a clarinet.

If you push the 8' Drawbar half-way, you'll notice the sound becomes more high-pitched and a bit “harder”. Now pull the 8' Drawbar back out fully and push the 2 2/3' and 1 3/5' in halfway. Notice how the sound becomes mellower.

Experiment with the Drawbars to obtain your own personal favorite sounds.

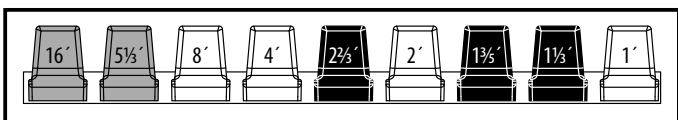

In the case of the Tone Wheel organ, refer the correspondence between each bar and the footage to the printing in front of the Drawbars.

DRAWBARS FOR THE UPPER AND LOWER PARTS

◆ PRESET KEYS AND DRAWBARS

There are 2 sets of Drawbars for Upper part on the left, Lower part on the right. Use Preset Keys [A#] and [B] to engage each one. The operation of the Drawbars is disabled when the other Preset Key is selected, basically.

NOTE: You can activate Drawbar operation whether Preset Key [C] to [A] is selected (P. 80).

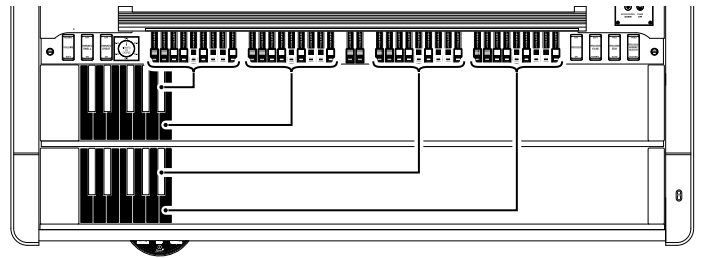

◆ WHITE DRAWBARS

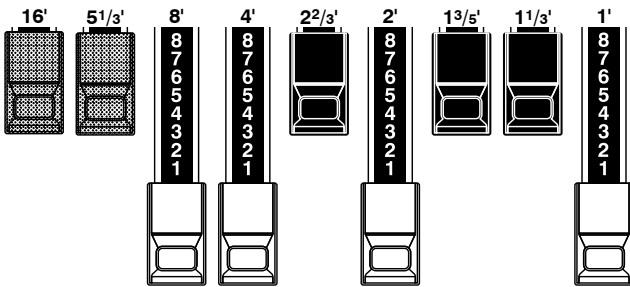

In each Drawbar set, the white Drawbar on the left side (8') provides the fundamental sound. The remaining white Drawbars sound higher by the octave as you move to the right.

◆ BLACK DRAWBARS

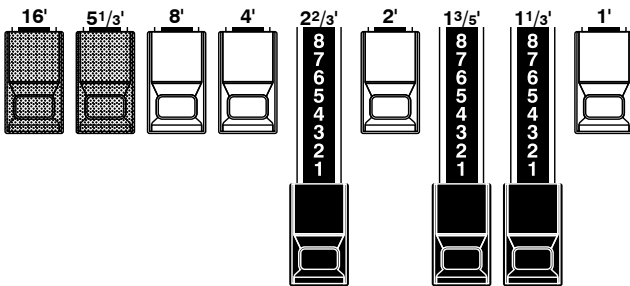

The sounds of the black Drawbars play an important role in building rich tones. Their pitches are fifth and third interval to the fundamental. These harmonics add complexity to the tone.

◆ BROWN DRAWBARS

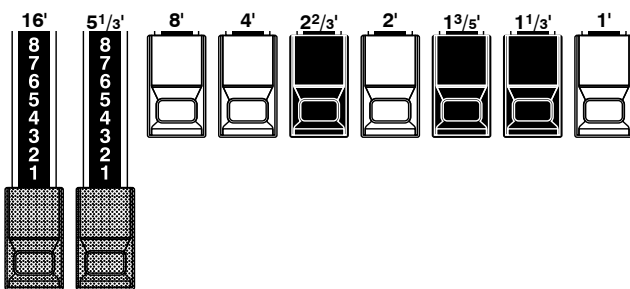

The two brown Drawbars on the far left give depth and richness to the sound. The left 16' is one octave lower than the 8', and 5 1/3' is the third harmonic of the 16' fundamental. Normally, the tones are built on the 8' fundamental, but, if you want to add depth to the tone or to expand the playing range by one octave lower, build your tones on the 16' fundamental.

DRAWBARS FOR PEDAL PART

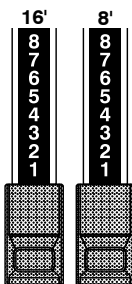

The Pedalboard plays the bass line and uses the 16' and 8' Drawbars. The first Pedal Drawbar produces a tone at 16' pitch for a deep foundation bass, while the second Pedal Drawbar produces a tone at 8' pitch, or one octave higher.

The registration of the Pedal part appears in the center of the display. 16' on the left and 8' on the right.

DRAWBAR REGISTRATION PATTERNS

The Drawbar Registration is matched by digits. It is easy to remember the typical combinations of the 9 Drawbars by their forms.

The Drawbar Registrations are grouped into the following 4 patterns:

◆ Flute family (2 step pattern)

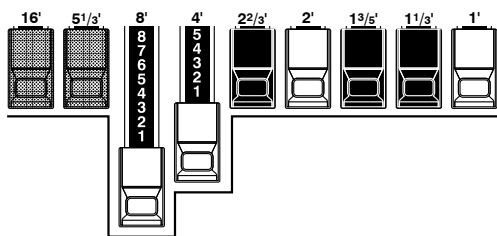

Accompaniment Flute 8' I.....	00 8460 000
Accompaniment Flute 8' II.....	00 3220 000
Accompaniment Flute 8' III.....	00 8600 000
Chorus of Flutes 16'.....	80 8605 002
Orchestral Flute 8'.....	00 3831 000
Piccolo 2'.....	00 0006 003
Stopped Flute 8'.....	00 5020 000
Tibia 8'.....	00 7030 000
Tibia 4'.....	00 0700 030
Tibia (Theater) 16'.....	80 8605 004
Wooden Open Flute 8'.....	00 8840 000

◆ Diapason family (check mark pattern)

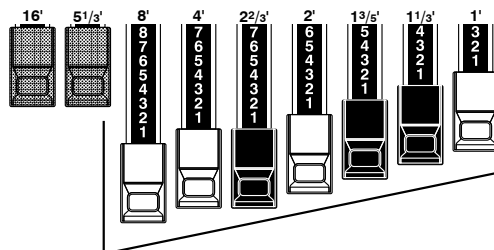

Accomp. Diapason 8'.....	00 8874 210
Chorus Diapason 8'.....	00 8686 310
Diapason 8'.....	00 7785 321
Echo Diapason 8'.....	00 4434 210
Harmonic Diapason 16'.....	85 8524 100
Harmonic Diapason 8'.....	00 8877 760
Harmonic Diapason 4'.....	00 0606 045
Horn Diapason 8'.....	00 8887 480
Open Diapason 8'.....	01 8866 430
Solo Diapason.....	01 8855 331
Wood Diapason 8'.....	00 7754 321

◆ Reed family (triangle pattern)

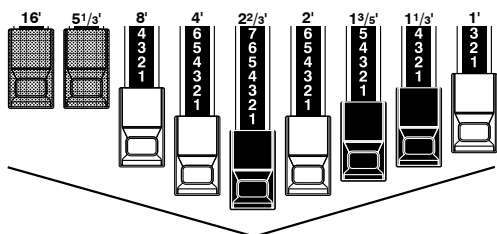

Bassoon 16'.....	44 7000 000
Clarinet 8'.....	00 6070 540
English Horn 8'.....	00 3682 210
Flugel Horn 8'.....	00 5777 530
French Horn.....	00 7654 321
Kinura 8'.....	00 0172 786
Oboe 8'.....	00 4764 210
Trombone 8'.....	01 8777 530
Trumpet 8'.....	00 6788 650
Tuba Sonora 8'.....	02 7788 640
Vox Humana 8'.....	00 4720 123

◆ String family (bow pattern)

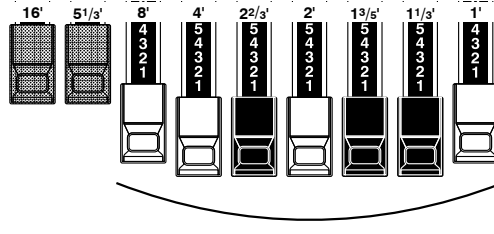

Cello 8'.....	00 3564 534
Dulciana 8'.....	00 7770 000
Gamba 8' I.....	00 3484 443
Gemshorn 8'.....	00 4741 321
Orchestral String 8'.....	00 1464 321
Salicional 8'.....	00 2453 321
Solo Viola 8'.....	00 2474 341
Solo Violin 8'.....	00 3654 324
Viola da Gamba 8'.....	00 2465 432
Violina 4'.....	00 0103 064
Violone 16'.....	26 3431 000

Notice that Drawbar registrations are expressed in number groups of 2, 4 and 3. This “2-4-3” number formula for Drawbar Registration has been a Hammond convention since the beginning. It has been found to be the easiest way to convey a specific setting. The first two numbers correspond to the two brown Drawbars of either manual. The middle four numbers designate the 8', 4', 2 2/3', 2' Drawbars, and the remaining three numbers refer to the last three Drawbars.

MODERN DRAWBAR REGISTRATIONS

The Drawbar registrations introduced on the previous page are typically for classical music.

They were created at the dawn of the Hammond Organ, when it was intended to sound like a pipe or church organ. Later on, as the Hammond Organ spread throughout Jazz, Pop, Rock and (especially) Gospel music, Some timeless registrations become common.

◆ Jazz

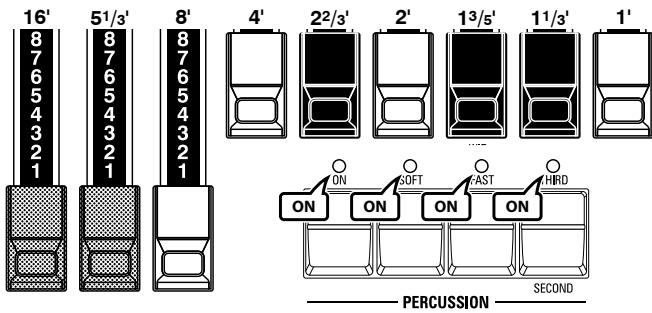

◆ Bluesy

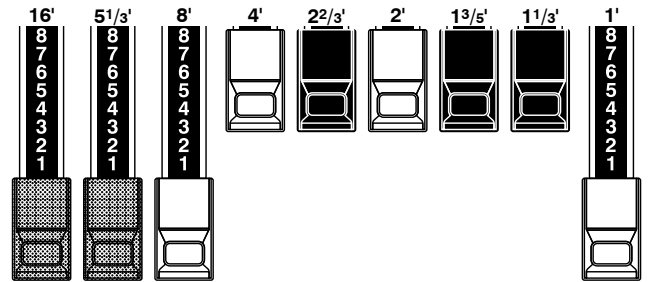

◆ Groovy & Funky

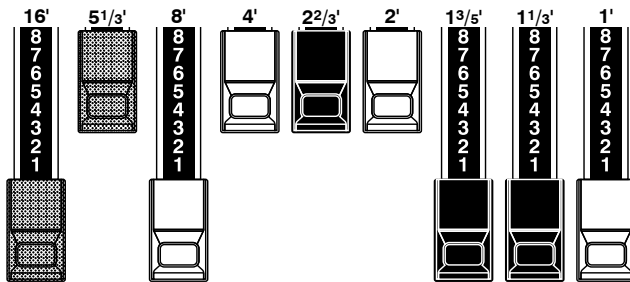

◆ Max Power

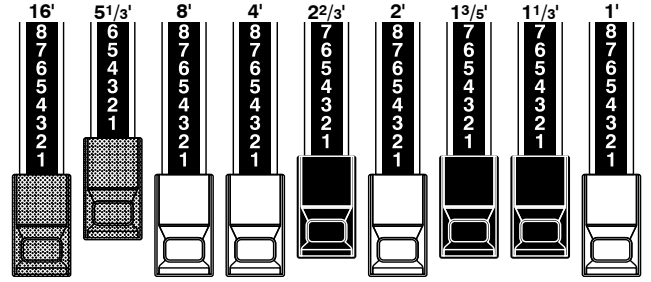

◆ Squabble

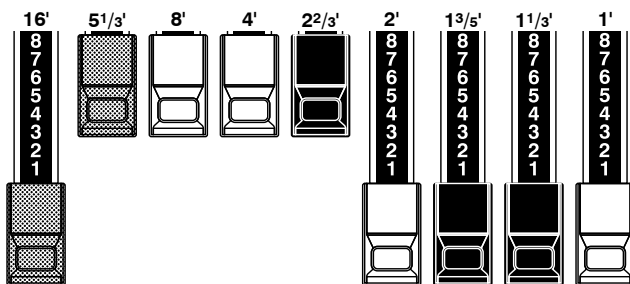

Setting Up

tips APPLICATION OF PERCUSSION

When Percussion is used, the sound of the 1' Drawbar is cancelled. As it was on the Vintage B-3. A trick is to keep the 1' Drawbar fully out, and then turn the Percussion on and off as you play for a instant change in sound. Try it!

DRAWBARS (Vx)

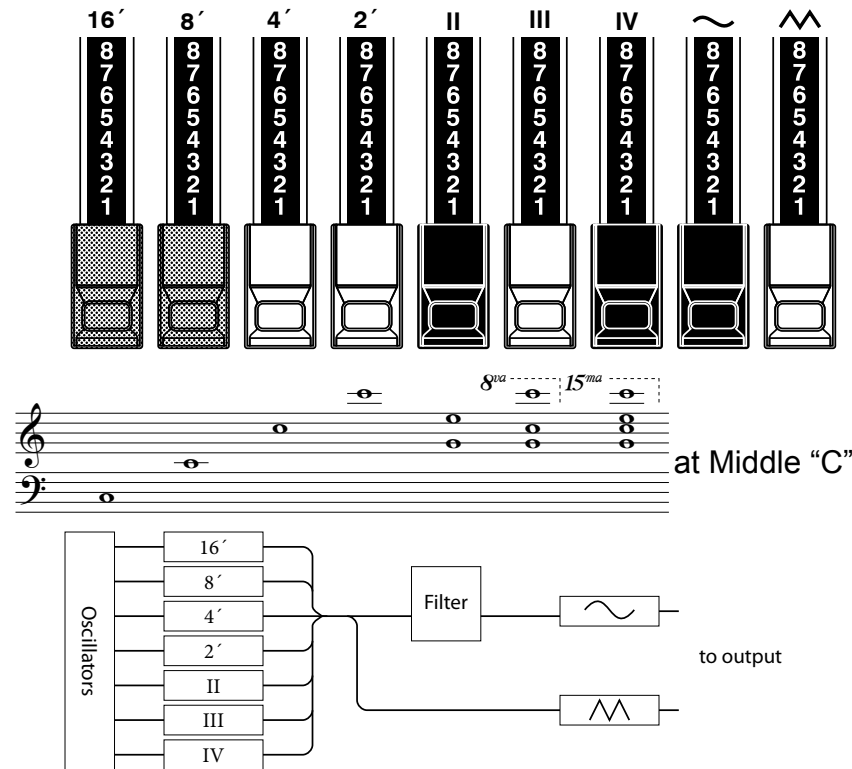

The original British Vx type organ was equipped with Drawbars, but the function was different from that of the Hammond Organ. The vintage arrangement has been re-created here.

Each of the 4 bars on the left functions similarly to the Hammond Organ. II, III and IV on the right are “Mixture” drawbars that sound plural pitches.

The 2 Drawbars on the right are a mini mixer controlling the mellow voice “~” or bright voice “^” as in the vintage combo organ.

Each or both of the two right-hand Drawbars must be pulled in some combination to hear sound in the Vx type.

tips FOOTAGE

The markings, “8; 4” etc., indicate the lengths of pipes corresponding to their pitch. The common term for these numbers are “footages”. For example, 8’ means that a pipe of 8’ in length sounds, the lowest C on a standard 5 octave organ keyboard.

Bass 16'	Strings 16'	Flute 8'	Oboe 8'	Trumpet 8'	Strings 8'	Flute 4'	Piccolo 4'	Strings 4'	Farf.
16'	8'	4'	2'	II	III	IV	~	^	Vx.
Bourdon 16'	OpenDiap 8'	Gedeckt 8'	VoixClst II	Octave 4'	Flauto 4'	Flute 2'	Mixture III	Hautbois 8'	Pipe

If the organ type is set to Vx, refer to the “Vx” row on the Footage Label for the correspondence between each bar and the footage (P. 161).

DRAWBARS (Farf)

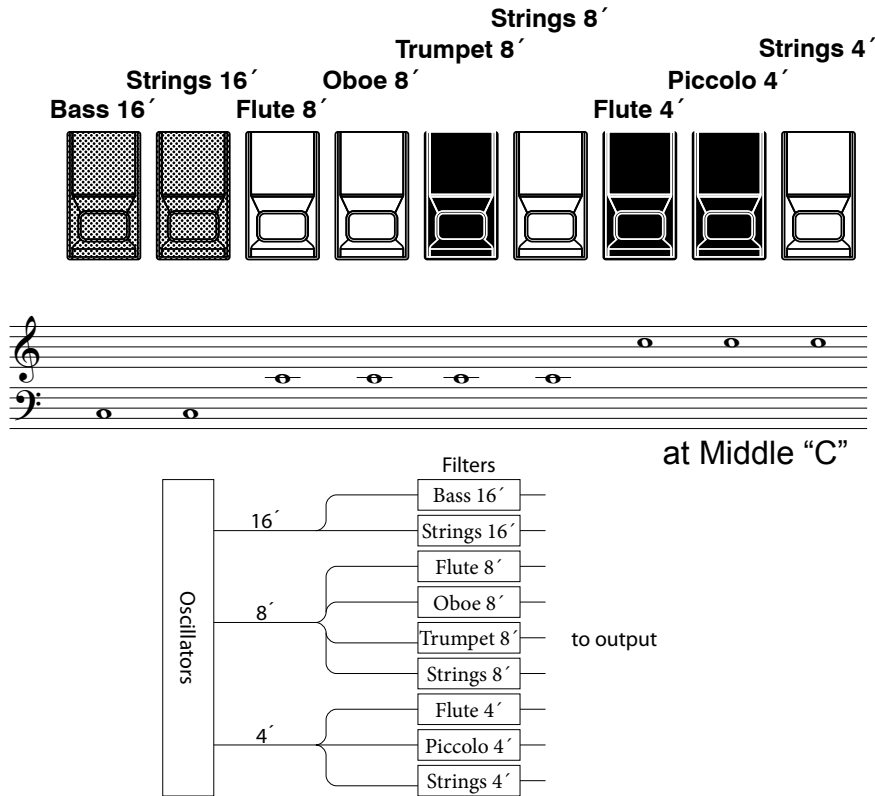

The original Italian Farf type organ was tablet-equipped with different sounds at various footages. On this keyboard the operation is made with Drawbars instead of tablets.

At the same footage, the tablets gives grow brighter in sound as you progress to the right. The names “Flute”, “Strings”, etc. are general descriptions and do not reflect the tonalities or characteristics of the real instruments.

Setting Up

Bass 16'	Strings 16'	Flute 8'	Oboe 8'	Trumpet 8'	Strings 8'	Flute 4'	Piccolo 4'	Strings 4'	/Farf
16'	8'	4'	2'	II	III	IV	~	^/\	/Vx
Bourdon 16'	OpenDiap 8'	Gedeckt 8'	VoixClst II	Octave 4'	Flauto 4'	Flute 2'	Mixture III	Hautbois 8'	/Pipe

When using the Farf type organ, refer to the “Farf” row on the Footage Label for the correspondence between each bar and the footage (P. 161).

DRAWBARS (PIPE)

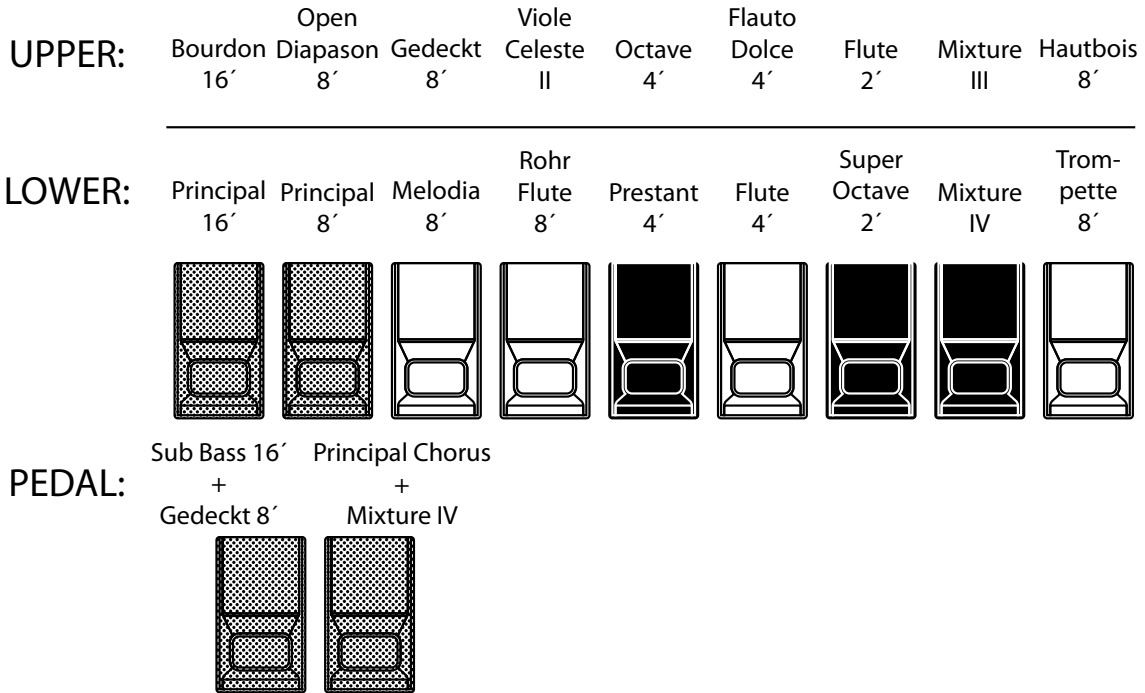

When using the PIPE organ type, the Stops are registered through the Drawbars, and follow the classic organ layout left to right as follows: Flue, Mixture and Reed.
 On the UPPER and LOWER parts, each Drawbar corresponds with a stop of the pipe organ.
 On the PEDAL part, two Stops sound with one Drawbar.

NOTE: When "Pipe" type is activated, the Drawbars will function similar to drawstops on a traditional pipe organ - pulling a Drawbar "out" will turn the associated Pipe Voice "ON" while pushing the Drawbar "in" will turn the Pipe Voice "OFF." The Pipe Voices do not have gradations of volume - they are either "ON" or "OFF."

tips STOP

A single voice or sound on a pipe organ is referred to as a "Stop" due to the fact that air flow is "stopped" (or started) by manipulating the individual knobs or tablets which turn sounds "ON" or "OFF".

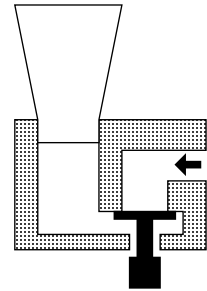

Bass 16'	Strings 16'	Flute 8'	Oboe 8'	Trumpet 8'	Strings 8'	Flute 4'	Piccolo 4'	Strings 4'	Farf.
16'	8'	4'	2'	II	III	IV	~	^^	/Vx.
Bourdon	OpenDiap	Gedeckt	VoixClst	Octave	Flauto	Flute	Mixture	Hautbois	Pipe
16'	8'	8'	II	4'	4'	2'	III	8'	

If the organ type is Pipe, refer to the "Pipe" row on the Footage Label for the correspondence between each bar and the stop (P. 161).

MATCH THE REGISTRATION TO DRAWBARS

When you recall a patch, the Drawbar registration of the recorded patch is heard, instead of the physical Drawbar setting.

If you move any Drawbar, its position takes precedence over the recorded registration by CONTROL - CONTROL MODE is set at "ALWAYS A#", although the recorded preset is not altered.

If you wish to switch to the A# Drawbars setting, Press and hold the corresponding button ([UPPER], [PEDAL]) in the PRESET SELECTOR until the light blinks then release it. The physical registration now becomes "current", [UPPER] button for UPPER A# Drawbars, [LOWER] button for LOWER A# and PEDAL Drawbars.

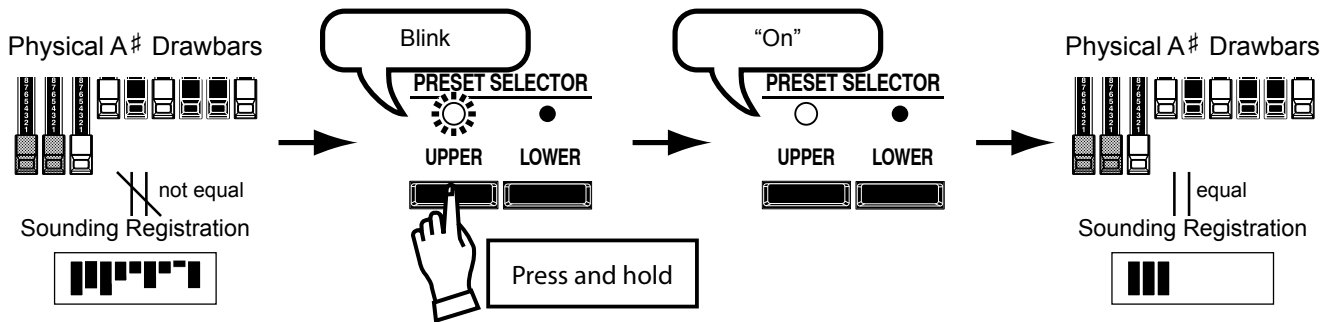

PERCUSSION

One of the most important features introduced with the Classic B-3 was “Touch-Response” Percussion, which added a distinctive and bright percussive highlight to the top of the Drawbar tone.

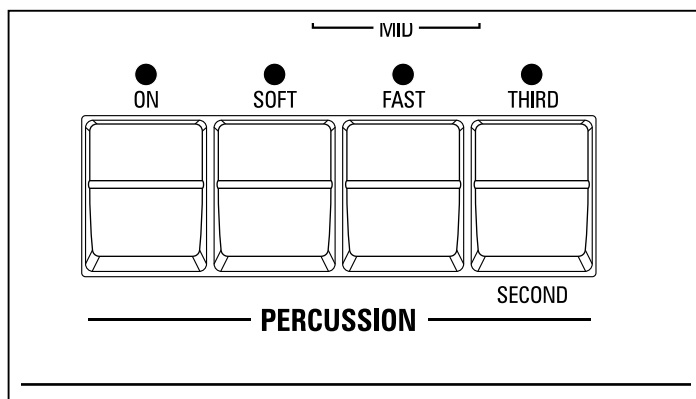

[ON] button

Switches the percussion “ON”(LED lit) and “OFF”.

[SOFT] button

This reduces the volume of the Percussion.

When the LED is OFF, it is “NORMAL”. If you press the [SOFT] button (LED is lit on), the Percussion level is “SOFT”.

[FAST] button

When this button is OFF (LED not lit) the percussion tone will decay slowly like a bell. When it is “ON” (LED is lit) the percussion tone will decay rapidly like a xylophone.

[THIRD] button

Switches the Percussion harmonic.

When this button is OFF, the second harmonic speaks at the same pitch as the 4’ Drawbar.

The third harmonic tone speaks at the same pitch as the 2 ²/₃’ Drawbar. To select, press the [THIRD] button (light on).

NOTE: The Percussion sounds on the “A-100”, “B-3”, “C-3” or “Mellow” Organ Types.

NOTE: You can fine-tune the parameters of the Percussion (P. 84).

tips DECAY

If you play and hold a Piano key, the sound will gradually fade away to silence, this is called “Decay”. Holding a note on a trumpet, for example, the sound is at a continuous volume. This is called “Sustain”

◆ PERCUSSION DOES NOT SOUND

The Percussion sounds only on the Preset Key [B] when the Preset Bank is [B] in factory default (left figure). This is same as B-3/C-3.

NOTE: You can set the Percussion sounds at every Preset Keys (P. 76 #8).

◆ 1’ DRAWBAR CANCEL

As on the B-3/C-3, the 1’ Tone Wheel Drawbar is inoperative when the Percussion is engaged.

NOTE: If you wish the 1’ Drawbar to remain operative, you can change the parameter (P. 84).

The Hammond Vibrato & Chorus is another hallmark of the Classic Hammond sound. Vibrato alters the pitch slightly, as a violinist, singer, or guitarist might do. Chorus combines a slightly detuned signal with the original for a lush tone.

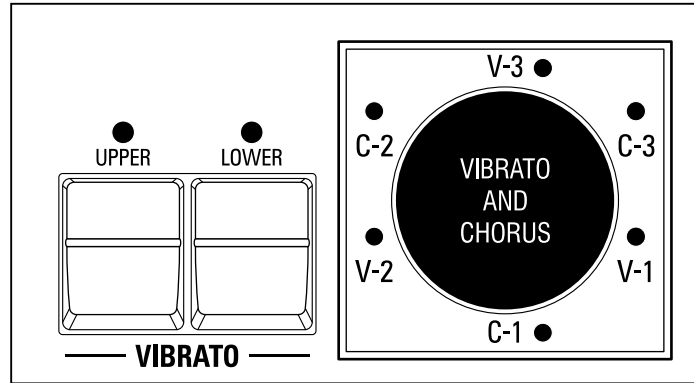

[UPPER] button

“ON”(LED lit) and “OFF” the Vibrato & Chorus effect on for the UPPER Drawbars.

[LOWER] button

“ON”(LED lit) and “OFF” the Vibrato & Chorus effect on for the LOWER and PEDAL Drawbars.

[VIBRATO AND CHORUS MODE] knob

This knob controls the depth of Vibrato and switches the Chorus effect “ON” and “OFF”.

- V-1:** Comparatively slight Vibrato
- V-2:** Standard depth Vibrato
- V-3:** Deepest Vibrato
- C-1:** Comparatively slight Chorus
- C-2:** Standard depth Chorus
- C-3:** Deepest Chorus

NOTE: The Vibrato & Chorus affects all organ types except “Pipe”.

NOTE: You can fine-adjust the Vibrato and Chorus effect (P. 85).

tips CHORUS

The CHORUS effects literally provide the roars and richness like unison of the chorus group. This keyboard has 3 functions named “CHORUS” as follows:
 “Vibrato & Chorus” of this page
 “Chorus” of Multi Effects
 Leslie Effect “Slow (Choral)”
 The names look similar but the effects are different.

Setting Up

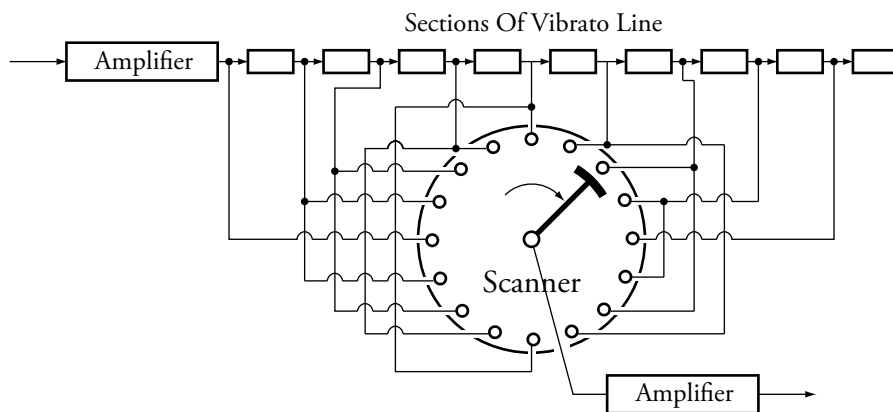

tips SCANNER VIBRATO

The Vibrato & Chorus equipped on the B-3/C-3 consists of circuit for delaying the phases of the tonal signals by steps using plural coils and a scanner for selecting each coil signal by the motor rotation and taking it out without touching.
 If the number of the coils used is small, it is shallow. If large, deep vibrato is obtained. At the same time, the tonal quality changes, due to the nature of the structure.
 The Vibrato & Chorus Effect on this unit simulates this.

OVERDRIVE

The Digital “Overdrive” circuit can provide tonal enhancement from a mild “Warmth” all the way to “Crunch Distortion”

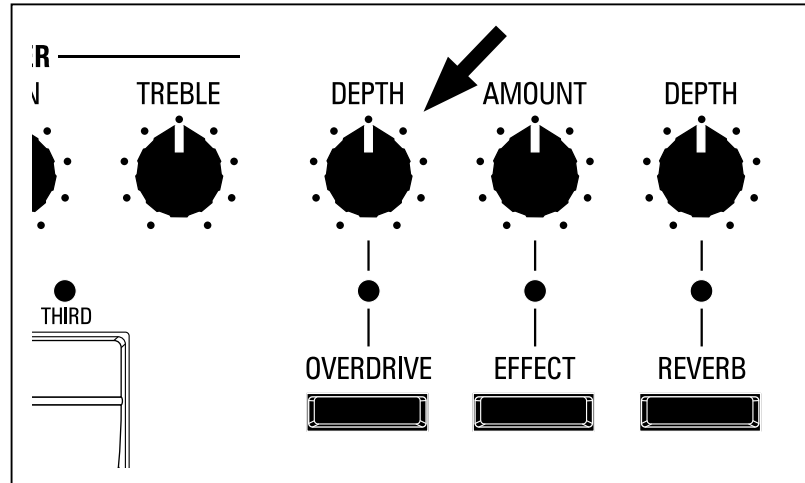

[OVERDRIVE] button

Switches ON(LED lit) or OFF the Overdrive effect.

[OVERDRIVE DEPTH] knob

Adjusts depth of the Overdrive effect.

NOTE: The Overdrive affects all organ types except “Pipe”.

NOTE: You can fine-tune the Overdrive effect (P. 101).

The rotating sound of the Leslie Speaker is the natural partner of the Hammond Organ. A digital version is built-in to the XK-5; and the controls will also function with a connected external Leslie speaker.

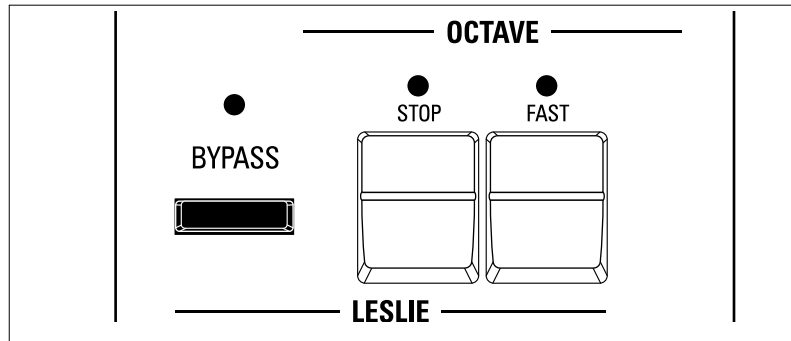

[FAST] button

Toggles the mode of the rotor by two steps. Every press switches the status. When the light is ON, the mode is FAST, and when it is OFF, it is not.

[STOP] button

To toggle the FAST and SLOW when you pressed the [FAST] button, press this button and the light OFF.

To toggle the FAST and STOP when you pressed the [FAST] button, press this button and the light ON.

[BYPASS] button

When the light is OFF, the sound is output from the rotary channel (Leslie effect).

To bypass the Leslie effect, press this button and the light will go ON. Regardless of the status of the [FAST], [STOP] buttons, the sound is output from the stationary channel.

NOTE: The Leslie affects all organ types except "Pipe".

NOTE: You can fine-tune the parameters of the Leslie effect (P. 86).

tips STATUS CHART OF EACH BUTTON

BUTTON			MODE	
BYPASS	STOP	FAST	CH=1	CH=3, on-board Leslie effect
Off	Off	On	Fast	
Off	Off	Off	Slow	
Off	On	On	Fast	
Off	On	Off	Stop	
On	On	On	Fast	Bypass
On	On	Off	Stop	
On	Off	On	Fast	
On	Off	Off	Slow	

Setting Up

Diagram of 3 channel Leslie Speaker

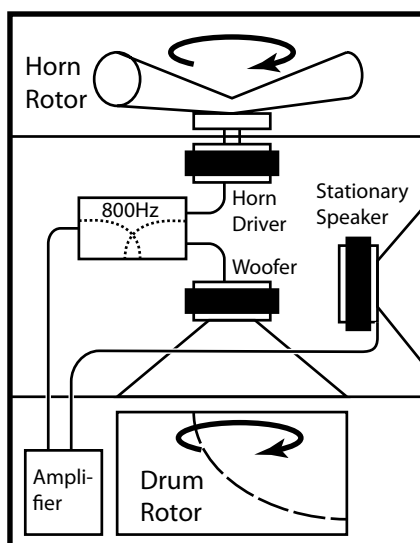

tips WHAT IS THE LESLIE EFFECT?

The Leslie Speaker was invented by Donald Leslie in 1941 to make the Hammond Organ sound like a Theatre Pipe Organ. Using motor-driven rotating horns and baffles, Leslie's invention gave the organ a rich and moving tone, which quickly became its own unforgettable sound.

In its basic form, the Leslie Speaker has an built-in amplifier and two rotors; the "Horn Rotor" for treble and the "Drum Rotor" (or Bass Rotor) for bass which are each fed by a custom-designed driver/speaker. The combination of the two utilizes the "Doppler Effect" to give the unique Leslie "swirling" sound.

Some models have not only rotors but also a fixed speaker. The circuit for sending the sound to the rotor is called the "Rotary Channel", and that for the fixed speaker is called the "Stationary Channel".

The Digital Leslie on-board the XK-5 employs all the proprietary concepts used in the physical speakers, but realizes them in the digital realm. It is recommended that you run the Main Outputs "in stereo" to get the fullest effect.

MULTI EFFECTS, REVERB

The XK-5 has on-board Digital Multi Effects and Reverb to enhance the playing.

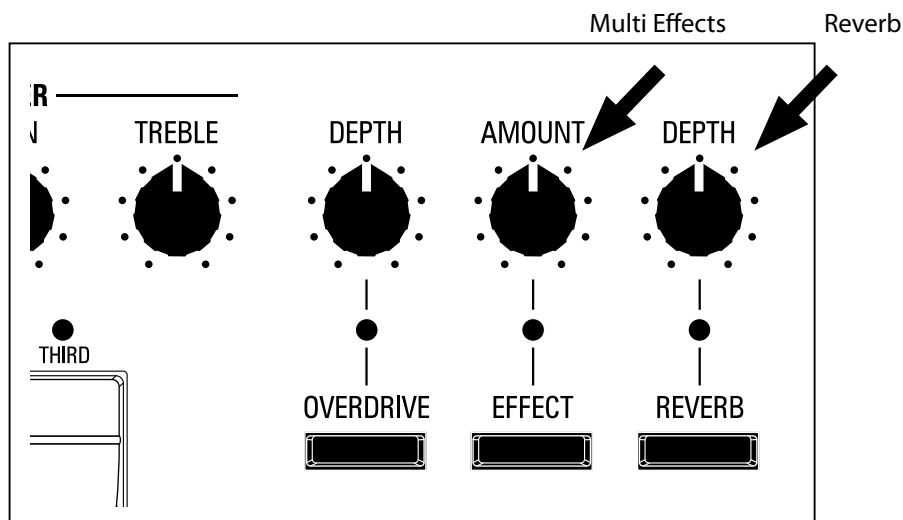

◆ MULTI EFFECTS

[EFFECT ON] button

Toggles “ON”(LED lit) and “OFF” the Multi Effects.

[EFFECT AMOUNT] knob

Adjusts the amount of the Multi Effects.

NOTE: When using “Pipe” Organ Type, some types of the Multi Effects are disabled; Tremolo, Wah-Wah, and Ring Modulator.

NOTE: There are numerous parameters in the Multi-Effects. The detailed settings of the parameters are adjusted on the control panel (P. 103).

◆ REVERB

[REVERB ON] button

Toggles “ON”(LED lit) and “OFF” the Reverb.

[REVERB DEPTH] knob

Adjusts the amount of the Reverb.

NOTE: There are numerous parameters in the Reverb. The detailed settings of the parameters are adjusted on the control panel (P. 111).

The transpose function allows you to shift the “key” in which the instrument sounds without changing the key that you are playing in.

For example, if you set Transpose at [+5], the note “F” sounds when you play the “C” key. (By playing in the key of C the XK-5 sounds in the key of F.)

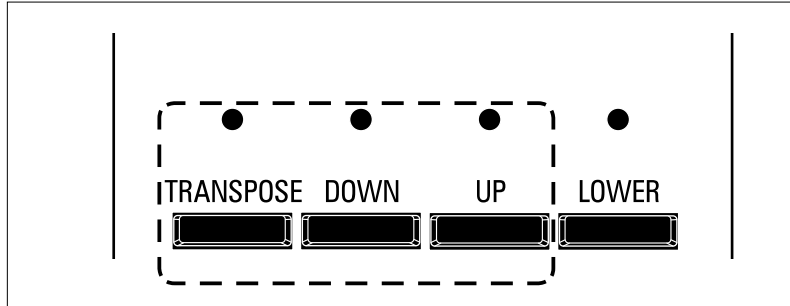

[TRANSCOPE] button

- ◆ To raise the pitch by semi-tone, press the [UP] button, while holding down the [TRANSCOPE] button.
- ◆ To lower the pitch by semi-tone, press the [DOWN] button, while holding down the [TRANSCOPE] button.

You can set Transpose in the range from -6 to +6 semi-tone.

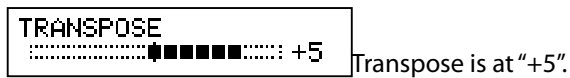

When performing this operation, the status of the transposition is shown in the display. The [TRANSCOPE] LED lights on if the value is not at 0.

◆ WHAT IS AFFECTED BY THE TRANSCOPE FUNCTION?

Transpose is mapped to the following points:

- Between the internal keyboard and the built-in sound engines.
- Between the MIDI IN and the built-in sound engines.
- To the External Zones.
- When the MIDI pedalboard XPK-100 is connected, transpose value will synchronize with it.

NOTE: Transpose is a temporary parameter, and is not recorded to any patch. When the power is switched OFF, it returns to 0.

SPLIT, OCTAVE

The XK-5 normal range is the UPPER Keyboard. A split is optional to place the LOWER keyboard parts on the left side of the single keyboard.

The keyboard can be shifted up or down one octave to facilitate easier play.

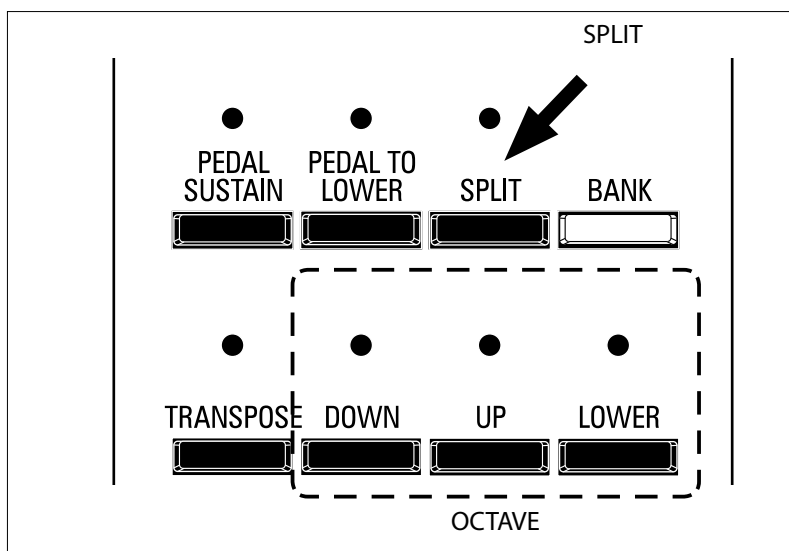

[SPLIT] button

Toggles the split the keyboard “ON”(LED lit) and “OFF”.

NOTE: You can set the split point. (P. 126)

[OCTAVE] buttons

Raises or Lowers each part by one octave.

- ♦ To raise UPPER by one octave, press the [UP] button.
- ♦ To lower UPPER by one octave, press the [DOWN] button.
- ♦ To raise LOWER by one octave, press the [UP] button, holding down the [LOWER] button.
- ♦ To lower LOWER by one octave, press the [DOWN] button, holding down the [LOWER] button.



Octave of LOWER is at “+1”.

When changing octaves here, the status of the Octave is briefly shown on the display.

You can bring the Pedal voice up to play on the lowest range of the Lower keyboard. (Pedal To Lower).

A popular option for playing the Pedals or Pedal To Lower is Pedal Sustain, which allows the Pedal voice to smoothly decay upon release, much in the manner of a string bass.

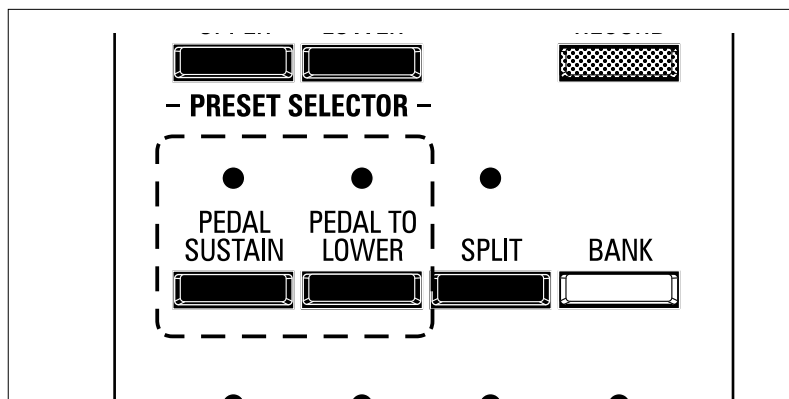

[PEDAL TO LOWER] button

Toggles the Pedal To Lower “ON”(LED lit) and “OFF”.

The keyboard that functions as the Pedal To Lower is the Lower range itself if it is on the XK-5 stand-alone, and the Lower keyboard if the Lower keyboard is added to the XK-5.

The default range of the Pedal To Lower is up to the middle “B”.

NOTE: You can change the highest note range of the Pedal To Lower (P. 126 #2).

NOTE: You can select the Pedal To Lower play chords or only the lowest note (P. 126 #1).

[PEDAL SUSTAIN] button

Toggles the Pedal Sustain “ON”(LED lit) and “OFF”.

After releasing your foot from the Pedal keyboard (or, if you release your finger from the Manual keyboard when you are using the Pedal To Lower) (= explained later in this manual), the sound will slowly fade, or decay.

NOTE: You can control the decay time of the Pedal Sustain (P. 75).

tips COUPLER

Like the Pedal To Lower, the function to set a keyboard to play two keyboards together is called “COUPLER”.

The settings you have prepared can be recorded to User Patches.

USER AND FACTORY

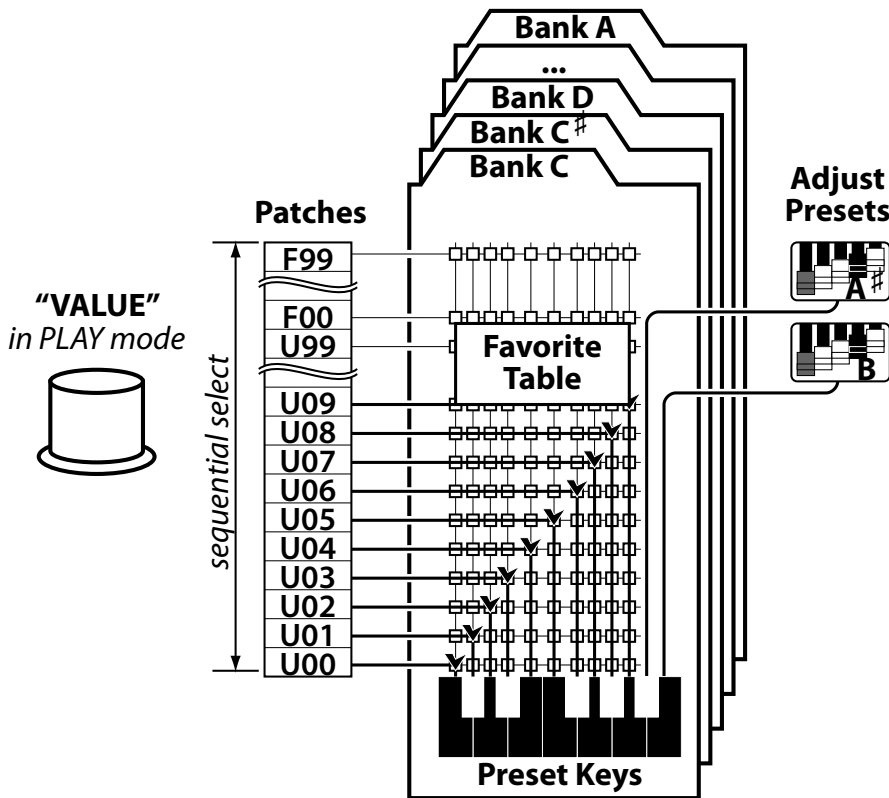

The PATCHES consist of “User’s Patches” from U00 to U99 and “Factory Patches” from F00 to F99 as shown left figure.

You can overwrite the “User’s Patches” by yourselves but not the “Factory Patches”.

To recall the Patches, select the Patch number using the [VALUE] knob in the PLAY mode, or use the Preset Key.

To record the current setting to the Patch, first put the name to it and designate the Patch number to record.

PATCH, FAVORITES, PRESET KEYS

◆ PATCH

The PATCH (on the left side of the illustration) is the basic memory unit on this instrument.

You can record the values of Drawbar Registrations or the effects.

◆ FAVORITES

The FAVORITES (in the center of the illustration) are the “table” for setting which Patches to recall/record with the Preset Key.

On the foregoing organs the correspondence of the Preset Key and the internal memory was fixed but it is freely assignable on this keyboard.

◆ PRESET KEYS

The PRESET KEYS (on the bottom of the illustration) are reversed black and white keys for recalling the Patches.

Which Preset Key to correspond with which Patch is set with FAVORITES.

The PRESET KEYS [A#],[B] (on the right side of the illustration) are special Presets called “ADJUST PRESET”. The “last status”, operated while the lamp of the key is ON, is always recorded, and, furthermore, the physical Drawbar Registrations and the internal registrations always match.

This is very helpful for making new Registrations or in the case of the “on the fly” style performance, moving Drawbars.

tips PATCH LOAD

Only the Drawbar Registrations for each keyboard were recorded on the B-3/C-3. The Patches on this unit allow many Parameters to be recorded in addition to the Drawbar Registrations.

If you want to recall certain specific Registrations such as “Drawbar Registrations, but only UPPER”, when you have selected Patches with the Preset Keys, set the “PATCH LOAD” (P. 76).

NAME THE PRESENT SETTING

① LOCATE THE MENU MODE

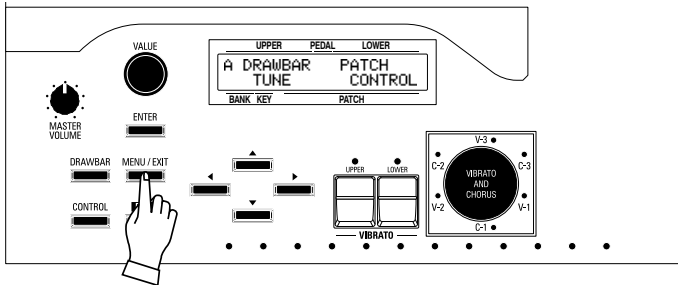

Press the [MENU/EXIT] button.
Menu mode will be displayed.

② LOCATE THE PAGE A

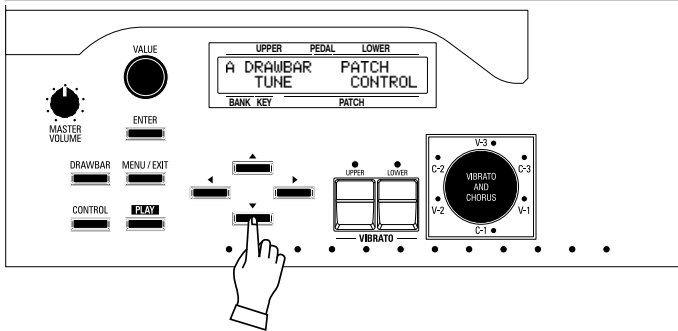

If Page A is not displayed, locate Page A by pressing [▼] button.

③ SELECT THE "PATCH"

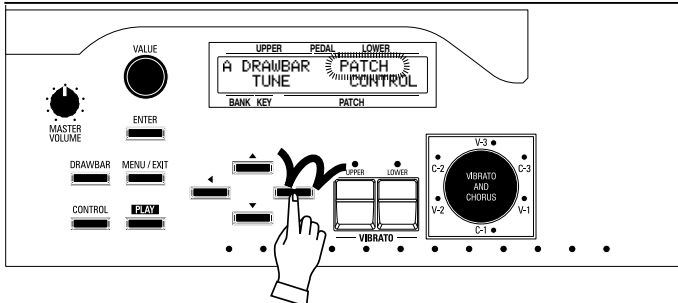

Press [▶] button twice and move the cursor to "PATCH".

④ GO TO PATCH FUNCTION MODE

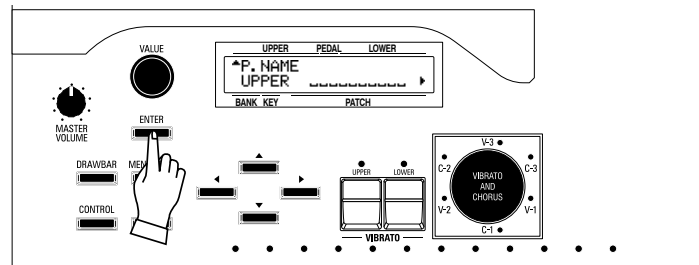

Press [ENTER] and go to PATCH function mode.

⑤ INPUT NAME

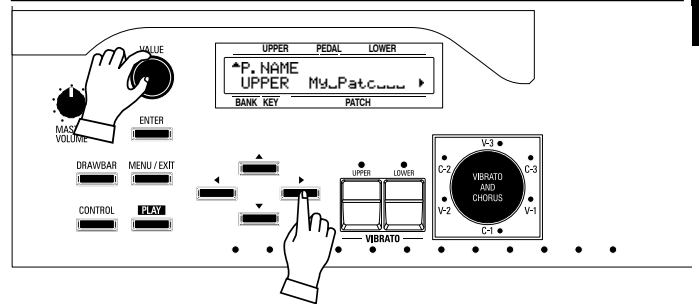

You can enter a name using up to 10 letters.

[◀],[▶] buttons: Moves the cursor.

[VALUE] knob: Selects letters.

The Characters available are the Capital and small English Alphabet, symbols and digits.

The name input here is not captured until you record the patch (as explained on the next page).

NOTE: This procedure is for naming the UPPER part. The LOWER part is named separately (P. 76).

RECORD TO THE PATCH

Example: RECORD TO “U32”

① ENTER THE NAME



Enter the name of your Patch. (P. 54)

② LOCATE THE RECORD MODE

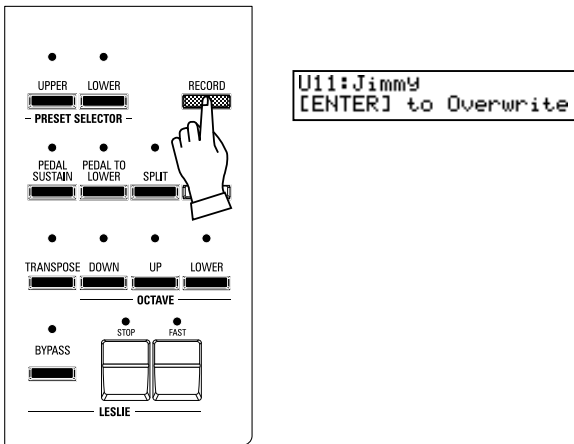

Press the [RECORD] button. The Record mode is displayed.

③ SELECT THE PATCH NUMBER

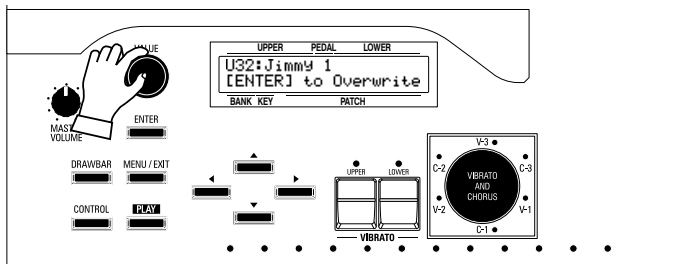

Select the patch number you wish to record with the [VALUE] knob (This time select U32).

④ PRESS [ENTER]

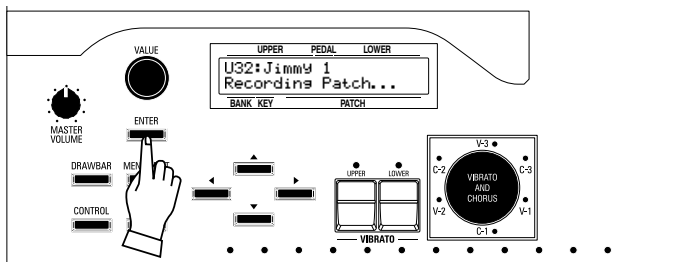

Press the [ENTER] button. The patch is confirmed and is displayed as follows for a few seconds:

Recording Patch...

When the recording is completed, the display returns to the previous one.

NOTE: The recorded patch data is retained if the power is switched off or disconnected.





**USING THE
CONTROL PANEL**

WHAT YOU CAN DO ON THE CONTROL PANEL

Your access to deep-editing the XK-5. All of the parameters and all of the controls not covered by the top panel knobs and switches are here.

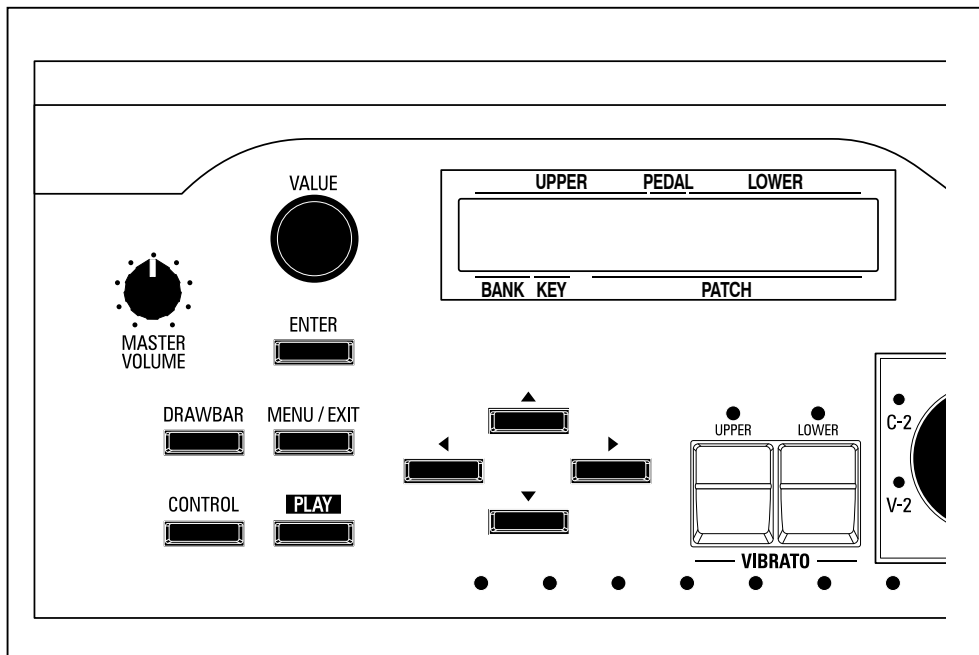

The available modes are, basically “PLAY”, “MENU” and “FUNCTION”. See how to read them and how to use the buttons on the next pages.

◆ **PLAY MODE** — ■■■ ■ 88 ■■■■
F#-D#:U64 Born To Be

◆ **MENU MODE** — A DRAWBAR PATCH
TUNE CONTROL

◆ **FUNCTION MODE** — ◆DRUM SLOW FAST
SPD 36 393 ▶

The Play mode is basic for all operations. All information necessary for ordinary performance is displayed here.

◆ **To locate this mode**

1. "Play mode" is the default mode at power-up.
2. If the Play mode is not displayed, touch the [PLAY] button.

HOW TO READ THE DISPLAY

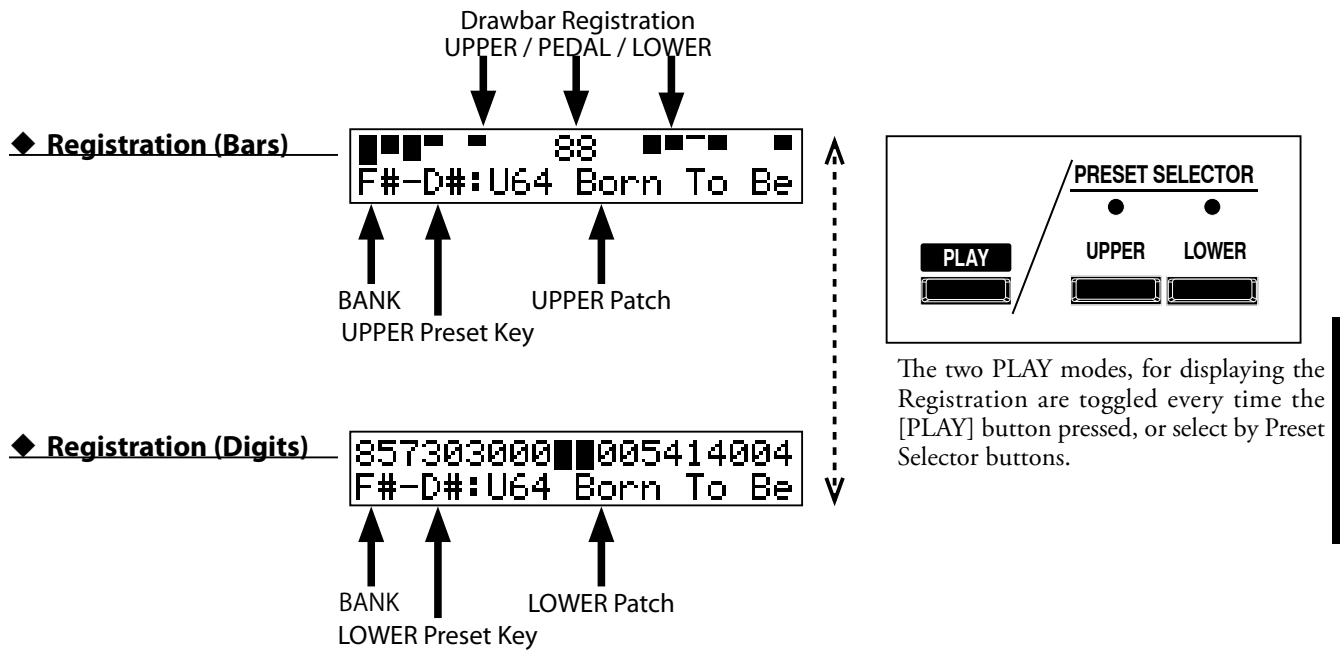

Control Panel

OPERATION IN THIS MODE

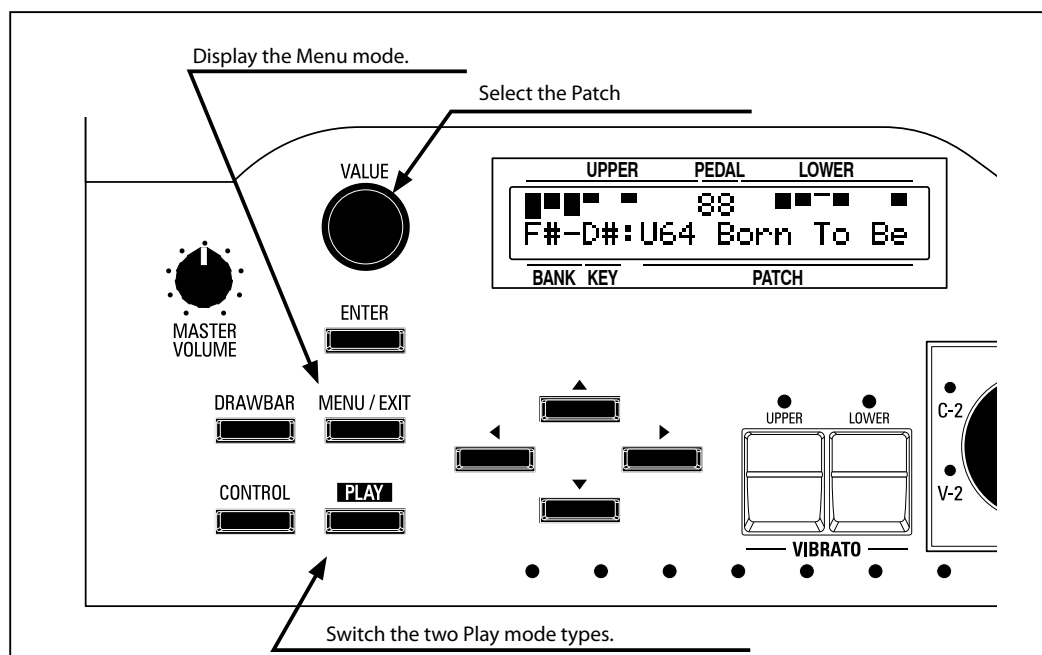

MENU MODE

The Menu mode provides a directory of all the various functions.

◆ **To locate this mode:**

Press the [MENU/EXIT] button.

There are many pages functions available to edit. A menu page has up to four items. Search for the item you wish to edit using the direction buttons, then press the [ENTER] button and enter each Function mode.

HOW TO READ THE DISPLAY

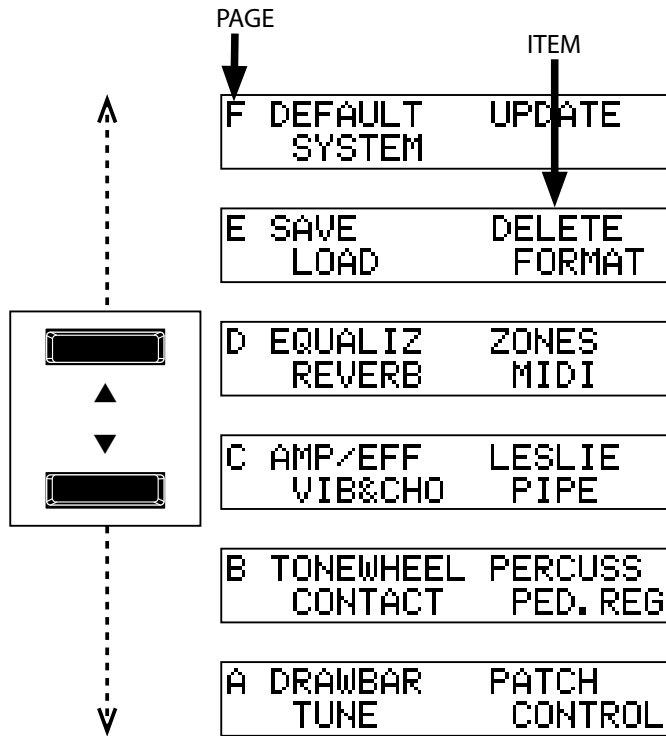

OPERATION IN THIS MODE

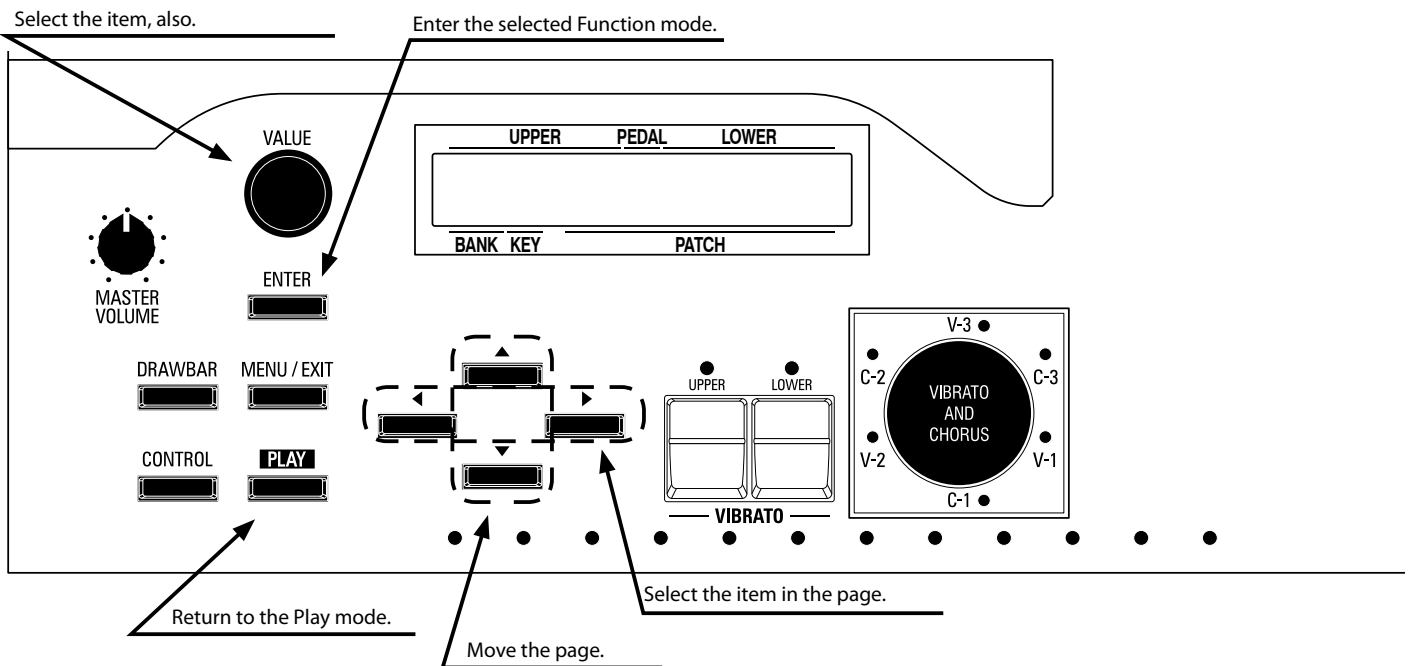

MENU AND THE CONTENTS

◆ PAGE A

1. **DRAWBAR**
Sets the parameters for the Drawbars of each part. (P. 74)
2. **TUNE**
Set the tuning and transpose of the entire keyboard. (P. 83)
3. **PATCH**
Patch naming, Parameter Load and assignment of Favorites. (P. 76)
4. **CONTROL**
For adjusting the controllers, such as the Expression Pedal and Foot Switch. (P. 78)

◆ PAGE B

1. **TONEWHEEL**
For custom setting of the Tone Wheel sets. (P. 89)
2. **CONTACT**
For custom setting of the virtual multi contacts. (P. 92)
3. **PERCUSS**
For custom setting the percussion parameters. (P. 84)
4. **PED. REG**
For custom setting the Pedal registration. (P. 96)

◆ PAGE C

1. **AMP/EFF**
Adjusts the pre-amplifier and the Multi-Effects here. (P. 101)
2. **VIB & CHO**
Adjusts the characteristics of the Vibrato & Chorus. (P. 85)
3. **LESLIE**
For custom setting of the on-board Leslie effect and sets the external Leslie speaker settings. (P. 86)
4. **PIPE**
For custom setting the Pipe Stops. (P. 98)

◆ PAGE D

1. **EQUALIZ**
Adjusts the Patch Equalizer and Master Equalizer. (P. 110)
2. **REVERB**
Adjusts the Reverb parameters. (P. 111)
3. **ZONES**
For setting the Internal Zone and External Zones. (P. 126)
2. **MIDI**
For setting the basic MIDI operations. (P. 128)

◆ PAGE E

1. **SAVE**
Saving the set-up to a USB Flash drive or Internal Memory. (P. 136)
2. **LOAD**
Loading the set-up from a USB Flash drive or Internal Mem-

ory. (P. 138)

3. DELETE

For delete a set-up file (P. 140)

4. FORMAT

For initializing the USB Flash drive. (P. 133)

◆ PAGE F

1. DEFAULT

For returning to the various factory default settings. (P. 112)

2. SYSTEM

For setting the System Parameters and displaying the System information. (P. 113)

3. UPDATE

Updates the system software. (P. 142)

FUNCTION MODE

These modes are for selecting and controlling the function.
All modes can be navigated the same way.

HOW TO READ THE DISPLAY

There is another page above (or below) this page.

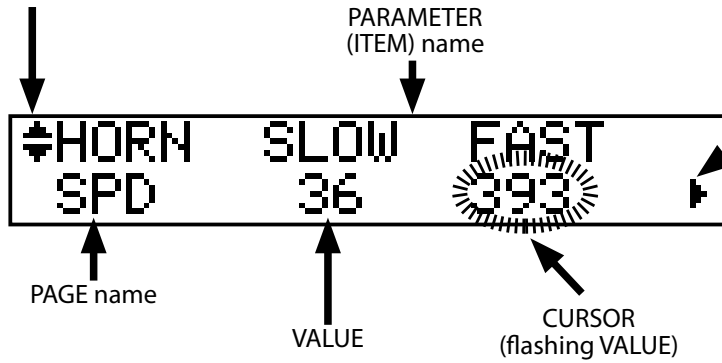

tips CURSOR

In this example the flashing "cursor" indicates the value of the fast speed of the Leslie.

OPERATION IN THESE MODES

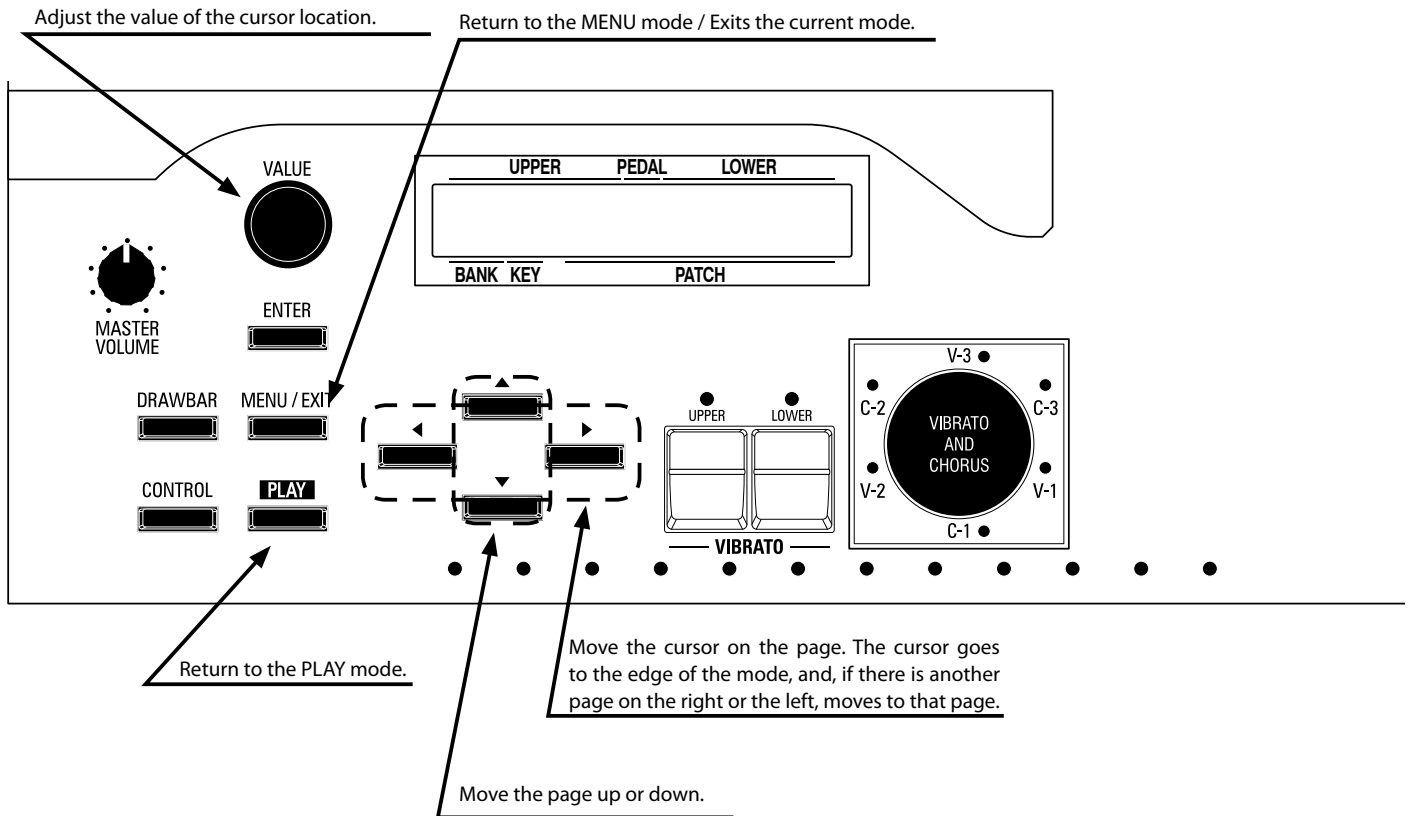

PARAMETER OPERATION EXAMPLE:

◆ ADJUST THE [FAST] PERCUSSION DECAY TIME

① LOCATE THE MENU MODE

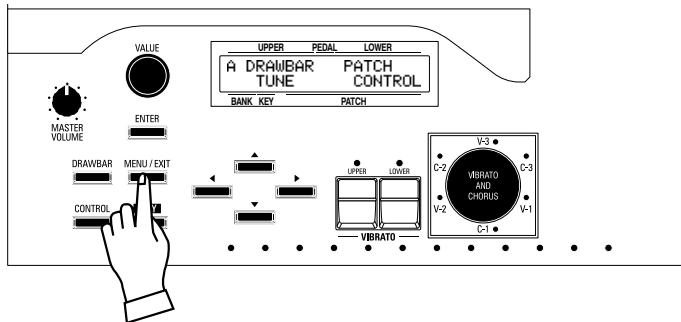

Press the [MENU/EXIT] button.
The MENU mode is displayed.

② SELECT THE MENU PAGE

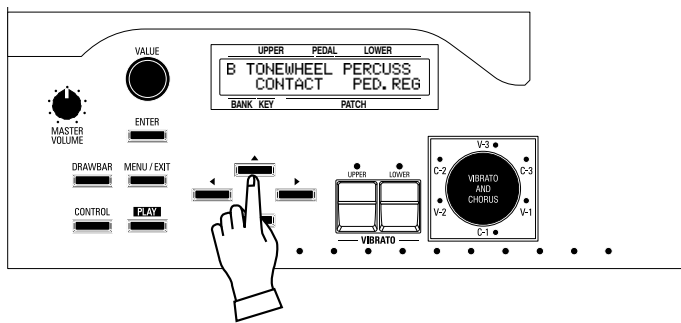

Locate the “PERCUSS” page using the [▲],[▼] buttons.
“PERCUSS” is on Page B.

③ MOVE THE CURSOR TO THE FUNCTION MODE YOU WISH TO LOCATE

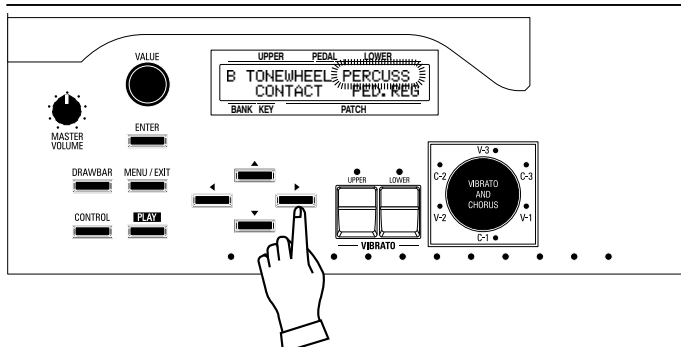

Move the cursor to “PERCUSS” using the [◀],[▶] buttons.

④ ENTER THE FUNCTION MODE

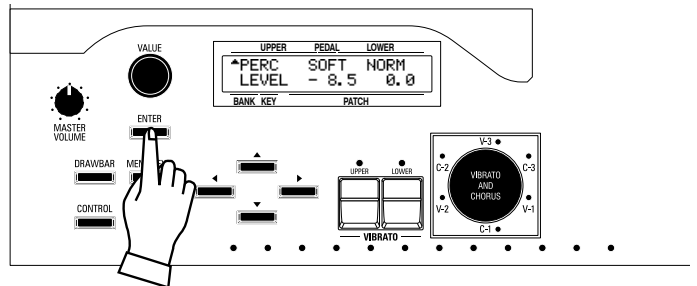

Press the [ENTER] button. The display shows the first page of the Percussion function mode.

⑤ MOVE THE CURSOR TO THE PARAMETER YOU WANT TO CHANGE

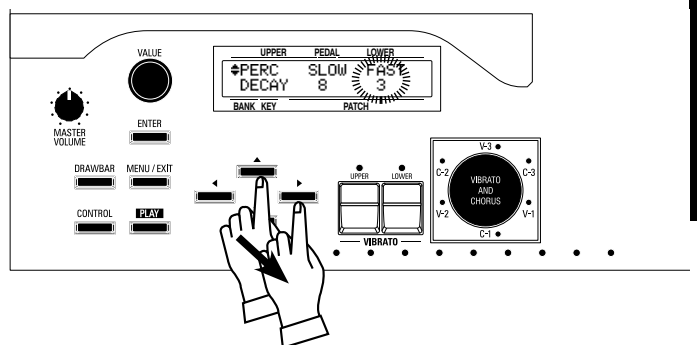

Decay time is on the “DECAY” page. Locate the “DECAY” page using the [▲],[▼] buttons.

“FAST” is on the right side of the page. Move the cursor (blinking value) to the right using the [◀],[▶] buttons.

⑥ CHANGE THE VALUE

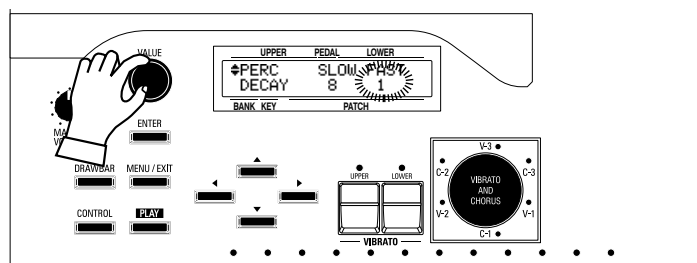

Decrease the value using the [VALUE] knob.

NOTE: If you want to change other items, repeat the process 1 to 6.

7 RETURN TO THE PLAY MODE

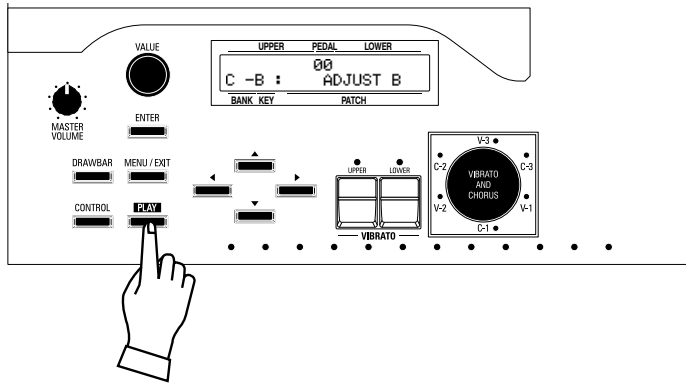

Press the [PLAY] button. The display returns to the PLAY mode.

8 RECORD TO THE PATCH IF DESIRED

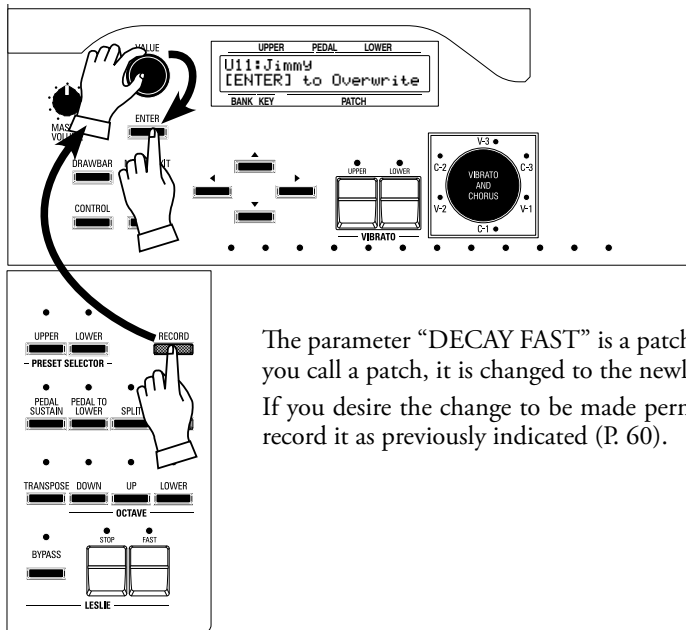

The parameter “DECAY FAST” is a patch parameter, so, when you call a patch, it is changed to the newly set value. If you desire the change to be made permanent for the patch, record it as previously indicated (P. 60).

tips PATCH PARAMETERS

Patch Parameters are unique to the current patch, and change with the programming of each patch. Many of the knobs/buttons on the top panel are “Patch Parameters”
The Parameters common to all the patches are called “Global Parameter”.

Each button on the top panel has a built in shortcut-making programming and editing easier.

Pressing and holding any of the buttons on the top panel automatically jumps the display to the related function menu item.

EXAMPLE OF OPERATION:

◆ LOCATE THE PERCUSSION FUNCTION MODE

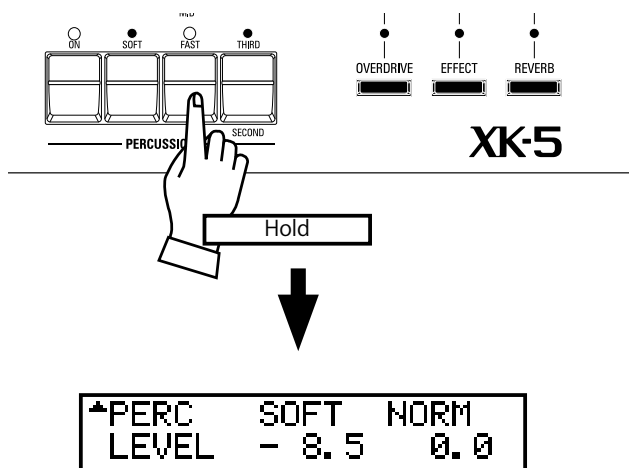

Here's an example of the "SHORT CUT" Function:

If you wish to edit the percussion settings, press and hold either of the [ON], [THIRD], [FAST], or [SOFT] buttons, and the display will immediately jump to the percussion function mode.

In the next chapter, you will see which button is used for a particular "SHORT CUT".

NOTE: Changing the length of time until display jump when button is held (P. 81).

REGISTER THE PAGE YOU FREQUENTLY USE

You can assign frequently-used function page to the [CONTROL] button for immediate access.

EXAMPLE OF OPERATION:

◆ REGISTER THE "DRAWBAR - PEDAL" PAGE

① LOCATE THE PAGE



Display the page you want to register using the MENU etc. For example, let's display the "Drawbar - Pedal" page.

② REGISTER THE PAGE

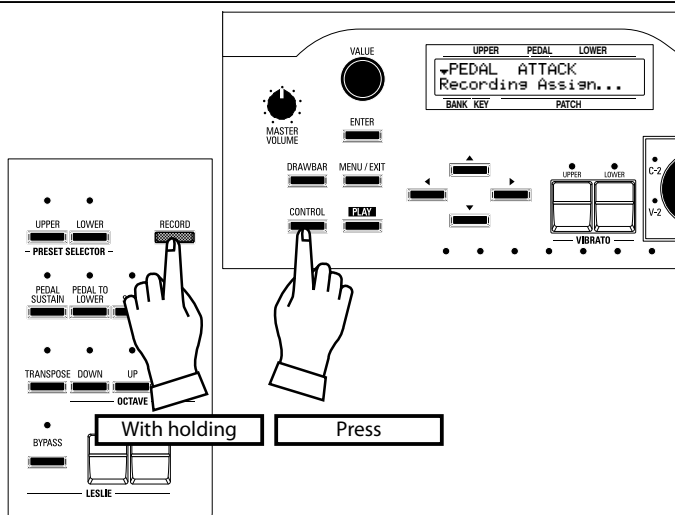

While holding down the [RECORD] button press the [CONTROL] button.

The display shows "Recording Assion" for a while. You will be able to immediately access the desired page by pressing the [CONTROL] button.

LOCKING THE DISPLAY

You can lock the display to avoid mistake while playing.

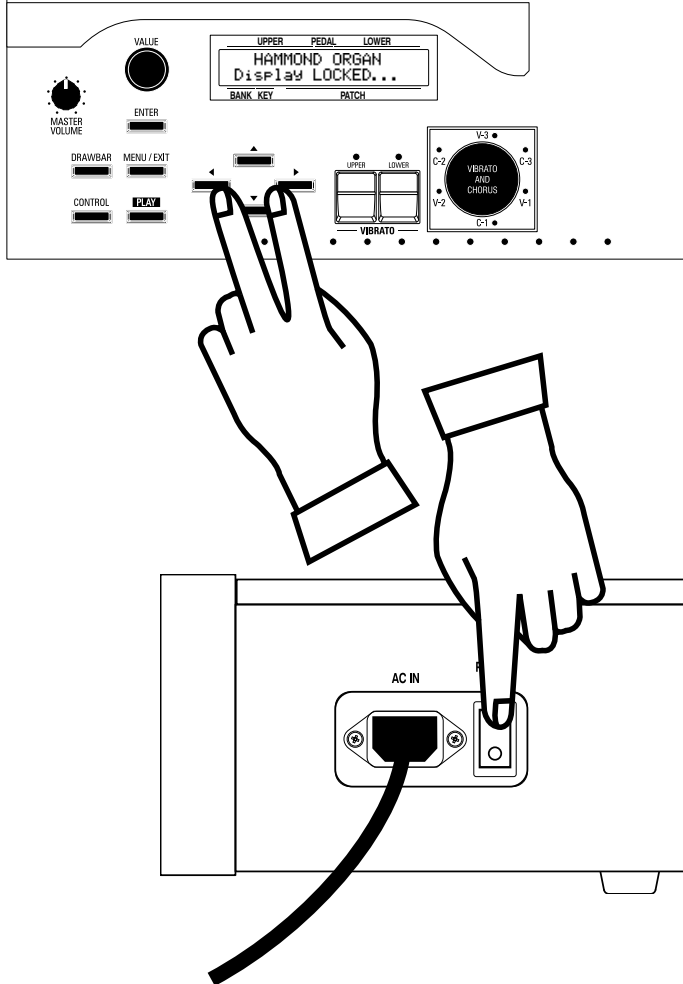

To lock the display, switch [POWER] on with pressing [◀] and [▶] until "Display LOCKED" is displayed.

To unlock this, repeat the operation above until "Display UNLOCKED" is displayed.

When "locked", the following conditions apply.

- ◆ [MENU/EXIT] button (P. 66) is disabled.
- ◆ [RECORD] button (P. 62) is disabled normally.
But you can record the Patch/Preset Key by switched "OFF" the Favorite before locking the display.
- ◆ "Short-Cut" function (P. 71) is disabled.
- ◆ [PRESET SELECTOR] buttons (P. 28) are still enabled.

NOTE: This feature will not released by Default-All or power on while holding [RECORD] button.

tips USING REGISTERED PAGE

The [CONTROL] button can register a page in function mode. Even if the display is locked, you can enter the registered page by using [CONTROL] button (P. 71).

However, you cannot move the cursor if the page has 2 or more parameters.

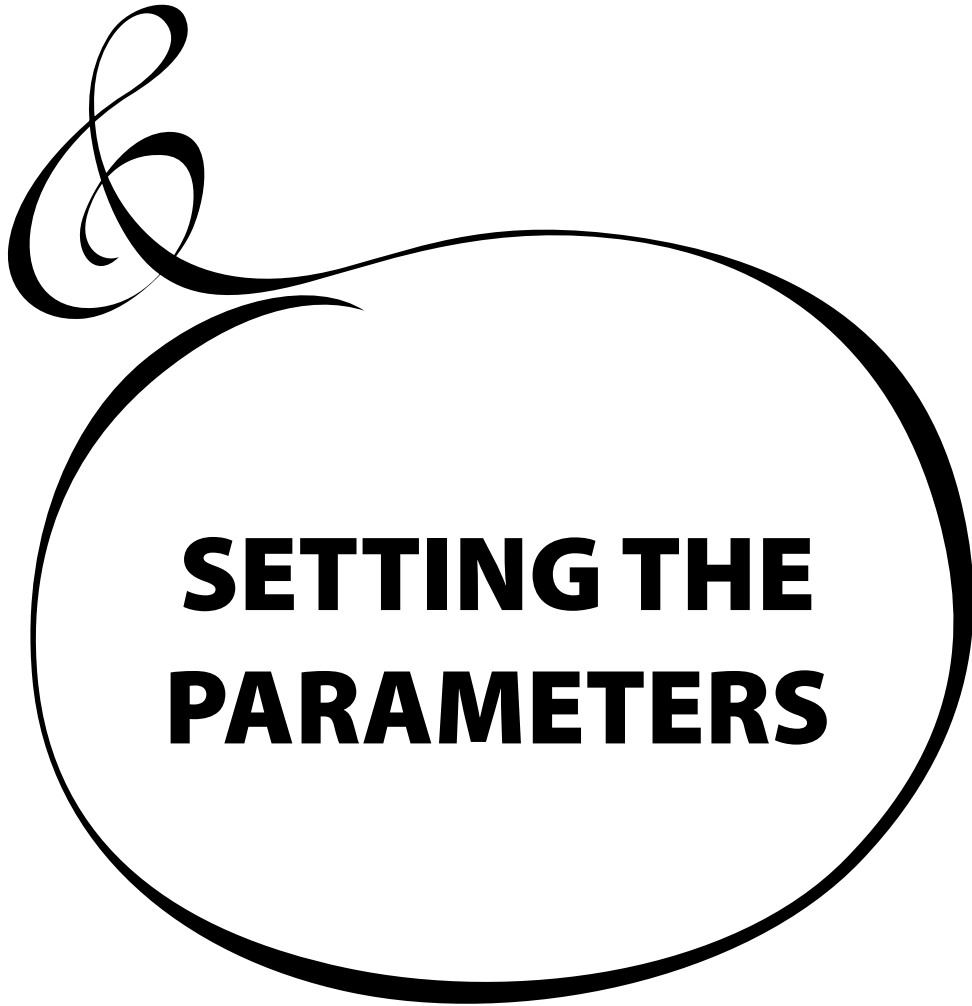
A decorative graphic featuring a large, stylized ampersand (&) on the left side. A thick black line starts from the bottom of the ampersand, curves around the top and right, and ends at the bottom of a large circle. The circle is empty and contains the text "SETTING THE PARAMETERS" in bold, black, uppercase letters.

**SETTING THE
PARAMETERS**

DRAWBAR

Drawbar sound parameters for each keyboard are set in this mode.

◆ To locate this mode:



See "Function mode" (P. 68) for operation details.

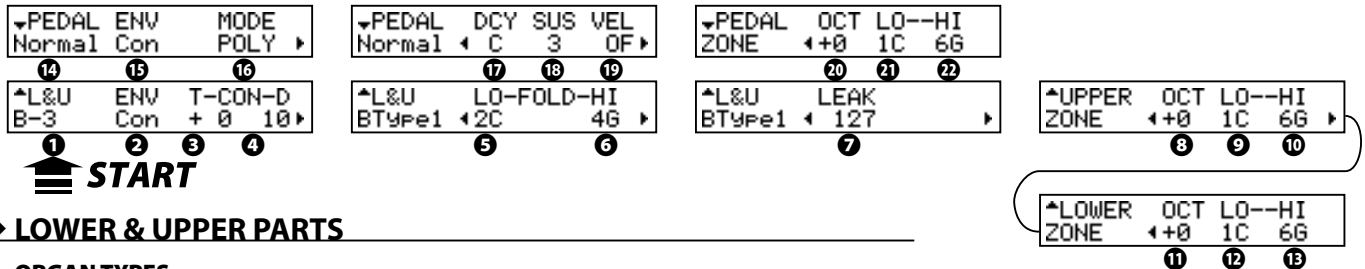

◆ LOWER & UPPER PARTS

1 ORGAN TYPES

Select the manual keyboard Organ Type.

A-100:	A-102 No. 35564
B-3:	B-3 No. A27563
C-3:	C-3 No. C155596
Mellow:	With transparent sine waves
Vx:	Transistor Organ, Vx type
Farf:	Transistor Organ, Farf type
Pipe:	Pipe Organ

NOTE: When the Organ Type is set at Vx or Farf, the parameters 5 to 7 are unavailable.

NOTE: When the Organ Type is set at Pipe, the parameters 2 to 7 are unavailable.

2 ENVELOPE

This is for setting the envelope at the time of ATTACK (when the key is touched) / RELEASE (when the key is released).

The setting range is Con (contact), R1 -- R15, AR1 -- AR15.

"Con" is the envelope of the key-click(s) generated with the Virtual Multi-Contacts.

1 -- 15 is the attack with the ordinary envelope generator. The higher the value rises, the slower gets the rate (speed of the start-up of Drawbar volume/ dropping speed of the volume).

As "R" changes only the Release rate, using the Attack of the Virtual Multi-Contacts, it can make a fast start-up and a slow drop of the volume.

And, as "AR" changes the rate of both Attack/Release, it renders the envelope like a Pipe Organ.

3 CONTACT TIME OFFSET

This is for controlling the time of the contacts of the Virtual Multi-Contacts to completely contact.

The setting range is -63 -- 0 -- +63. The higher the value rises, the longer attack and shorter release takes.

4 CONTACT DAMPING

This is for controlling the damping rate of the Virtual Multi-Contacts.

The setting range is 0 -- 31. The higher the value rises, the larger gets the key-click.

5 FOLD BACK - LOW

Sets the key-point from which the 16' Drawbar folds back (= repeat the same octave on the lower octaves of the keyboard).

The bottom key on the keyboard is displayed as "1C". The setting range is 1C to 2C.

6 FOLD BACK - HIGH

Sets the key from which the 1' Drawbar folds back (= repeat the same octave on the higher octaves).

The setting range is 4G to 5C.

NOTE: The Fold-back occurs not only with 1' but also with 1½', 1¾', 2', 2¾' Drawbars.

tips TONE WHEEL SET

There are variations available for each virtual Tone Wheel set of A-100, B-3, C-3 and Mellow. (P. 163)

tips ENVELOPE

The variation of a sound over time, as is used in sound synthesis.

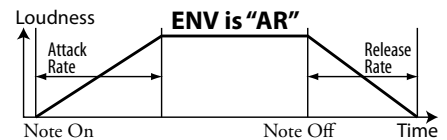
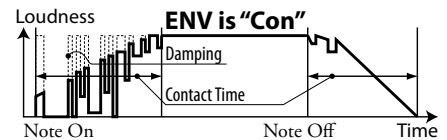

tips KEY CLICK

On the traditional models such as B-3/C-3, a noise occurred when keys were pressed and released, due to the mechanical keying system employed on the classic organs. That characteristic is replicated here.

tips EXAMPLES OF KEY-CLICK SETTINGS

Simulation of classic multi-contact keyboard B-3/C-3: ENV=CON

Simulation of a PCM synthesizer to produce the key-click only at 'attack': ENV=R1

Slow envelope like a pipe-organ: ENV=AR15

tips FOLD-BACK

As the number of the Tone Wheels was limited on the B-3/C-3, the very highest and lowest pitches "folded back" on the keyboards, sounding the same octave twice in a row. This function reproduces this characteristic.

On some earlier model, such as the A, BV, and BC, the 16' Drawbar would continue to play all the way down to the lowest C(1C). Newer models such as X-66, X-77 and Concorde, however, the 1' Drawbar would continue to play up the keyboard to the next to the highest C(5C) on the keyboard.

7 LEAK LEVEL OFFSET

Sets the total volume of the leakage tone.
The setting range is 0(silent) to 127(maximum).

8 UPPER ZONE OCTAVE

Set the octave shift for the UPPER part. The setting range is -2 to +2.

9, 10 UPPER ZONE LOW/HIGH

Set the sounding range of the UPPER part with these two parameters.

11 LOWER ZONE - OCTAVE

Set the octave shift for the LOWER part. The setting range is -2 to +2.

12, 13 LOWER ZONE - LOW/HIGH

Set the sounding range of the LOWER part with these two parameters.
See P. 118 for details of **8** to **13**.

◆ PEDAL PART**14 ORGAN TYPE**

Set the Organ Type for the Pedal part.

Normal: The traditional Tone Wheel sound of the B-3/C-3.

Muted: Analog oscillating sound as heard on the Classic X-5.

NOTE: When the "Vx" or "Farf" is selected by **1**, the "Muted" will selected absolutely.

NOTE: When the "Pipe" Organ Type is selected by **1**, only Pipe Organ pedal sounds are heard, regardless of this parameter. Also, parameters **15** to **19** are unavailable.

15 ENVELOPE

Sets the attack and release envelope.
See **2** for details.

16 KEY MODE

This allows you to set the Pedal polyphony.

POLY: Makes it possible to play chords(up to 3 notes).

MONO: Only the lowest note will sound, when you play a chord.

NOTE: If the Pedal to Lower is used, the Pedal part sounds with regarding Pedal to Lower mode (P. 126) regardless this parameter.

17 ENVELOPE - DECAY RATE

This allows you to determine whether the Pedal voice remains at the same volume as a note is held, or if the voice decays, as like a plucked string.
The setting range is 1(short) - 5(long) and C(continuous).

18 ENVELOPE - SUSTAIN LENGTH

This allows you to set the Release Rate (= the decay time after key release), when the [PEDAL SUSTAIN] button is ON.

1 is the shortest, and 5 is the longest decay time.

NOTE: You can locate this page by holding down the [PEDAL SUSTAIN] button as well.

19 VELOCITY

This allows you to set the response to playing velocity. The setting range is OFF and 1 - 4. At OFF, the volume does not change however hard you play the key. As the value increases from 1 - 4, the sounds gets louder even if the key is played softly.

20 PEDAL ZONE - OCTAVE

Set the octave shift for the Pedal part. The setting range is -2 to +2.

21 PEDAL ZONE - LOW**22 PEDAL ZONE - HIGH**

Set the sounding range for the Pedal part with these two parameters.
See page 118 for details of **20** to **22**.

tips LEAKAGE TONE

On the original B-3/C-3, while the sound created by a certain Tone Wheel goes through various circuits, the sounds of the other plural Tone Wheels are mixed. This is called Leakage Tone. Leakage tone itself is unnecessary for synthesizing pure sounds. However, it is accepted rather as one of the unique characteristics of Hammond Organs. Leakage Tone allows you to make finer adjustment (P. 89).

tips SUSTAIN

Unlike synthesizer nomenclature, on the this keyboard "Sustain" refers to note decay after note release. On a synth envelope generator this setting would be called "T4" or "Release".

tips ZONES

The "ZONES" set in these function pages are the range of each part of the organ section. The keyboard on the XK-5 is used in two sections: the organ section (as explained on this page) and the External Zone. The concept of "Zone" is for avoiding any confusion. For details see P. 118

NOTE: All the parameters in these modes are Patch Parameters. They are recorded into the Patch.

PATCH

In this mode you can name your Patch, set which parameters load, and how to link to the Preset Keys.

◆ To locate this mode:



See “Function mode” (P. 68) for operation details.

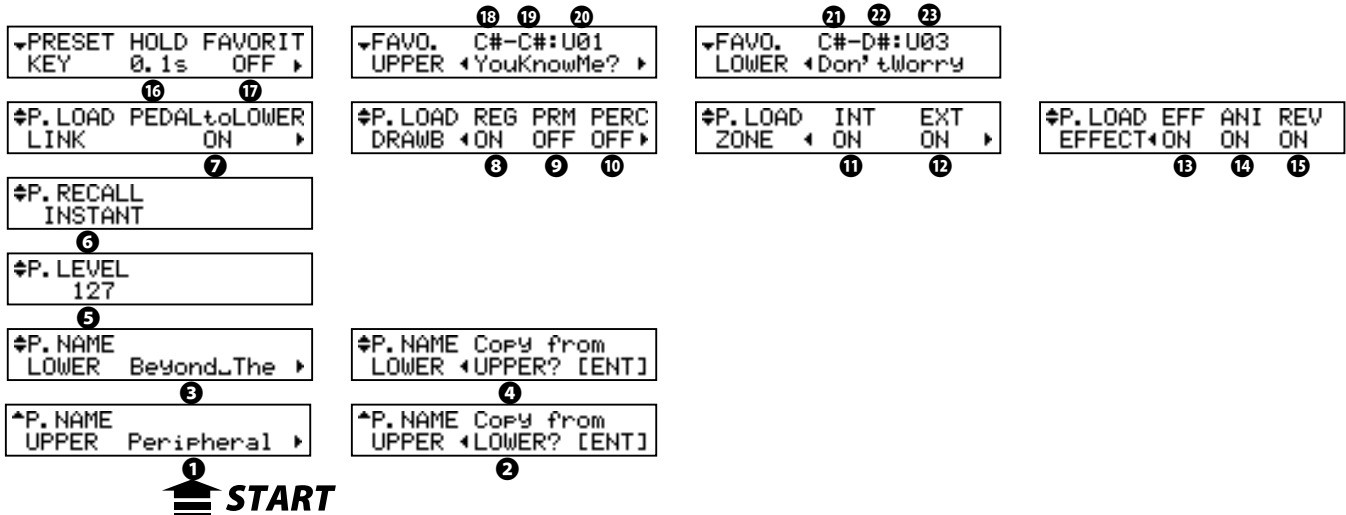

START

◆ PATCH NAME

A Patch has each name for UPPER and LOWER.

① UPPER (P), ③ LOWER (P)

Name the present patch using up to 10 letters.

Move the cursor by the [◀][▶] buttons. Then select letters with the [VALUE] knob.

② COPY FROM LOWER, ④ COPY FROM UPPER

Copies the Patch name from another part. Press the [ENTER] button at this page to copy.

◆ PATCH LEVEL

⑤ PATCH LEVEL (P)

Adjusts the present Patch volume. It is controlled by MIDI control change #7 “Volume” also.

The setting range is 0 to 127.

NOTE: These parameters 1, 3 and 5 (P) are Patch Parameter. They are recorded in each patch. They are lost unless you save the patch.

◆ PATCH RECALL

⑥ PATCH RECALL (G)

Sets the way to the decision when recall a Patch number.

INSTANT: The Patch is recalled instantly by [VALUE] knob is turned.

ENTERED: The Patch is recalled when [ENTER] button is pressed after [VALUE] knob is turned.

NOTE: “G” means “Global”. These parameters will be recorded when set, and are common in each Patch.

◆ PATCH LOAD

These are for setting which parameters are loaded when a Patch is called by Preset Keys. Sets whether or not to load:

⑦ PATCH LOAD - PEDAL TO LOWER (B)

Whether the parameters of the Pedal part are loaded when the Lower Patch is recalled.

⑧ PATCH LOAD - REGISTRATION (B)

Drawbar registration.

tips PATCH NAME PER PARTS

On the Preset Key of the B-3/C-3 memorized different named registration on the same key like this;

Swell C#: Stopped Flute

Great C#: Cello

The B-3/C-3 had no “display” for the names, so Hammond provided stickers for the user to attach to the proper Preset Keys.

To simulate that, this keyboard has Patch names per part. The Names will appear in the display when in “PLAY” Mode.

tips

WHERE IS RECORDED PATCH LEVEL?

The Patch level is recorded into UPPER part of the Patch.

The current Patch level does not changed if the LOWER Patch is recalled.

9 PATCH LOAD - PARAMETERS (B)

The parameters such as organ type or envelope.

10 PATCH LOAD - PERCUSSION (B)

The parameters relating to Percussion. And, whether Percussion sounds any Preset Key is selected.

11 PATCH LOAD - INTERNAL ZONE (B)

The parameters relating to Internal Zone, Pedal to Lower.

12 PATCH LOAD - EXTERNAL ZONE (B)

The parameters specific to the External Zone controlling external MIDI equipment.

13 PATCH LOAD - DRAWBAR EFFECT (B)

The parameters relating to Patch Level, Overdrive, Multi-Effects, Equalizer.

14 PATCH LOAD - ANIMATION (B)

The parameters relating to Leslie and Vibrato effects.

15 PATCH LOAD - REVERB (B)

The parameters relating to the Reverb effect.

NOTE: Each Patch Load parameter (B) is a Bank parameter. Common for each patch in the current Bank.

It is recorded when the value is set.

◆ PRESET KEYS

16 PRESET KEY - HOLD (G)

This is for setting the time for the Patch to be actually recalled, by holding down the Preset Key.

The setting range is 0.0 -- 1.0 [sec].

17 FAVORITE -SWITCH (G)

This is for setting whether or not to use the Favorite function of the Preset Key.

OFF: The Preset Key acts like that on the foregoing XK-3. Each of the Preset Keys "C-C" -- "A-A" corresponds with the Patches U00 -- U99 respectively.

If you press the Preset Key holding down the [RECORD] button, the Patch is recorded.

ON: The Preset Key recalls the Patch in accordance with the Favorite Table.

If you press the Preset Key holding down the [RECORD] button, It associated between current Patch and the Preset key on the Favorite Table.

◆ FAVORITE TABLE

This is for displaying and changing the Patch referred to each Preset Key. This is called Favorite Table.

18 UPPER BANK (G), 19 UPPER KEY (G), 20 UPPER PATCH (G)

21 LOWER BANK(G), 22 LOWER KEY (G), 23 LOWER PATCH (G)

First select the BANK **18/21** and KEY **19/22** of the Preset Keys you want to associate then select the PATCH **20/23**.

You can also locate these pages by holding down each of the Preset Keys [C] -- [A] for a certain length of time.

NOTE: "G" means "Global". These parameters will be recorded when set, and are common in each Patch.

When Favorite is "OFF"

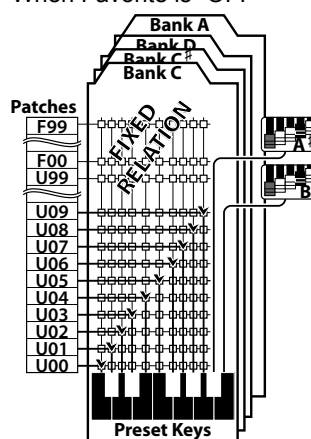

To record a Patch:
[BANK] + Preset Key,
[RECORD] + Preset Key

To assign a Favorite:
None

When Favorite is "ON"

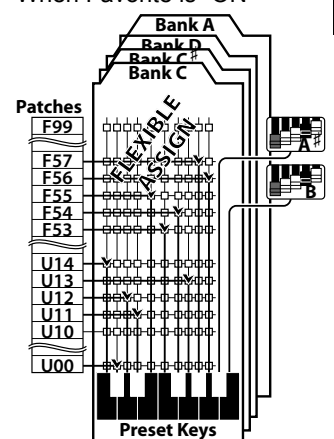

To record a Patch:
Press [RECORD],
Select Patch# by [VALUE],
and Press [ENTER]

To assign a Favorite:
Select a Patch by [VALUE],
[BANK] + Preset Key,
[RECORD] + Preset Key

CONTROL

This mode is for setting the controllers.

Please insure that the Expression Pedal and Foot Switch are properly connected before adjusting their settings.

◆ **To locate this mode:**



See "Function mode" (P. 68) for operation details.

↵DISP SH. CUT TIMEOUT 1 sec NO 27 28	↵DISP POPUP 1.0sec 29	
↕DRAW- MODE ASGN BARS ALWAYS A# OF 22 23	↕ASGN ZONE CC# 5-1/3 XU1 7:Volume 24 25 26	
↕OCT- DOWN BTN ORIGIN 19	↕OCT- UP BTN ORIGIN 20	↕OCT- LOWER BTN ORIGIN 21
↕SUS- UPPER LOWER TAIN 5 5 17 18		
↕DAMP- UP LOW PED ER ON ON ON 14 15 16		
↕GLIDE RANG TIME AMP 24 2.0s ON 11 12 13		
↕EXPR SOURCE MON ESSN EXP. PEDAL 127 4 5	↕EXP. LEV LF-LIM-HF MIN -35 -25 -30 6 7 8	↕EXP. GAIN CRV MON CALIB 100% 1 127 9 10
↕FOOT CTRL1 MODE CTL EXPRESSION 1	↕FOOT CTRL2 MODE CTL DAMPER 2	↕FOOT ON EXP MODE SW LESLIE S/F ALT 3

START

◆ **FOOT CONTROLLER**

❶ **FOOT CONTROLLER 1 - MODE**

This sets the foot controller function which connected to the CTRL1 jack.

- OFF** Does not function.
- EXPRESSION** Use this option when the Expression pedal is connected. Below options are for foot switch.
- LESLIE S/F ALT, MOM, TRI** Switches the Leslie Effect Slow/Fast/Stop.
 At ALT, Fast / not (Slow or Stop - it set by [STOP] button) is toggled every time the foot switch is pressed.
 At TRI, it is switched to Stop when the foot switch is further held down for longer than a second.
 At MOM, it is switched to Fast only while the foot switch is held down. When released, it is switches to not (Slow or Stop - it set by [STOP] button).
- GLIDE** The pitch bends while the foot switch is pressed down the interval is determined by a parameter setting.
- PATCH FWD, REV** Advances the Patch Forward or Reverse it.
- FAVORITE FWD, REV** Advances the Favorite Forward or Reverse it.
- SPRING** This generates the sound of the spring reverb being shaken.
- DELAY TIME** Sets the delay time (P. 111) of the Effects, at the interval of pressing the foot switch. The delay sound goes out, while the foot switch is held down.
- DAMPER** Holds played notes while the foot switch is depressed as does the damper pedal on a piano.
- SUSTAIN** Sounds of Upper and Lower parts are gradually fades while the foot switch is depressed.
- PEDAL TO LOWER** Triggers the Pedal to Lower note of Pedal part.
- BASS 1C - BASS 3C** Triggers the specified note of Pedal part. BASS 1C - 3C.
- P. CHORD CLOSE, OPEN** Triggers the Prochord function, closed or opened voicing.

tips PATCH/FAVORITE FWD/REV

Which part of the Patch/Favorite is sequentially selected by the Foot Switch depends on the setting of the [PRESET SELECTOR] buttons (P.28) and Pedal To Lower (P. 76).

When the "FAVORITE" is selected by ❶ to ❸, it advances Preset Key C through A, when the over the A or C, the next or previous Bank will be selected (upper of the below figure).

When the only [LOWER] of the [PRESET SELECTOR] is "On", the advance is looped in the same Bank (lower of the below figure).

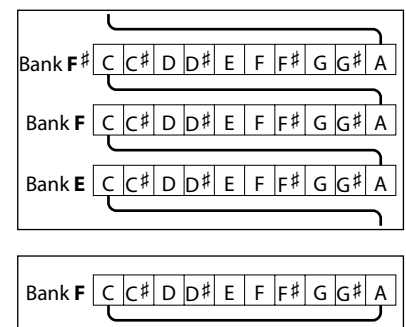

2 FOOT CONTROLLER 2 - MODE (G)

This sets the function of the foot controller connected to the CTRL2 jack.

3 FOOT SWITCH ON EXP. PEDAL - MODE (G)

This sets the foot switch function equipped on the EXP-100F, XPK-3, PK-25PXX or XPK-250W.

◆ EXPRESSION

4 EXPRESSION - SOURCE (G)

Sets the source of Expression control.

EXP. PEDAL:

For using Expression pedal.

MIDI: For using Expression information received at the UPPER keyboard channel.

BOTH: Both sources above are received. The last value of each is enabled.

5 EXPRESSION - MONITOR

Displays the current value of expression. In case of no sound or no change when the expression pedal is pressed, this monitor shows whether the expression value changes or not, so you may discover the cause of trouble (if any). This can also be an indicator when playing from low volume to fade in.

6 EXPRESSION - MINIMUM LEVEL (G)

Sets the volume at minimum expression.

The setting range is OFF, -40dB to 0dB. At OFF the instrument is silent when Pedal is at Minimum (all the way back). The other value points represent the lowest volume that will be present at the Pedal's minimum position.

7 EXPRESSION - LIMIT LOW FREQUENCY (G)

8 EXPRESSION - LIMIT HIGH FREQUENCY (G)

Sets the amount of Low or High Frequency to remain, when the expression is set at minimum.

The setting range is OFF, -40dB to 0dB. At OFF the sound totally disappears, but at other value points the set volume is kept, even if the expression is at minimum.

9 EXPRESSION - GAIN (S)

Adjusts the gain (range) of the connected expression pedal.

Set at minimum value when you step the expression pedal at maximum and the value displays "127".

10 EXPRESSION - CURVE (S)

Adjusts change of expression value corresponding to the angle of the depressed expression pedal.

The setting range is 1 to 3. Refer each curve to the right illustration or try playing live to discern which curve is correct for you.

NOTE: The parameters indicated (S) are system parameters. They are recorded when set, and are common in each Patch.

◆ GLIDE

11 GLIDE - RANGE (P)

Sets the bend range of pitch by semi-tone. Setting range is -24 to +12.

12 GLIDE - TIME (P)

Sets the time from the start of glide to reach the pitch set at (11). The setting range is 0.1 to 5.0 seconds.

13 GLIDE - AMP (P)

Engages a "fade" along with the Glide, where the volume drops in tandem with the pitch to total silence.

tips PROCHORD

"PROCHORD" function which adds complex harmonic voicing to single notes played on the UPPER manual based on chord structures played on the LOWER manual.

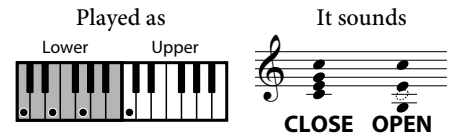

tips EXPRESSION LIMIT

One of the human ear's characteristics is that when the volume falls, the sound of high or low frequency becomes difficult to hear. On this model, it is rectified. The volume is maintained above a certain level even when the volume goes down in order to keep the sound of high or low frequency audible. The similar function is adopted on most home audio equipment. It is called the "loudness" function.

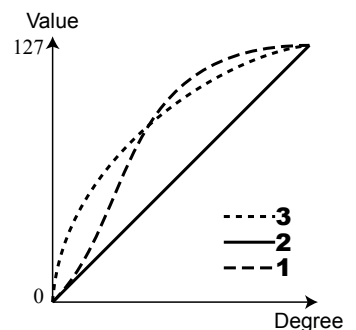
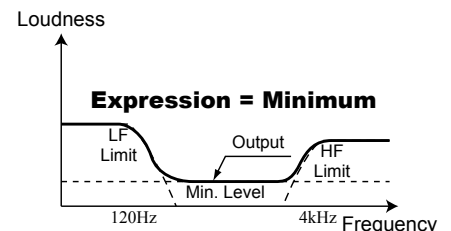
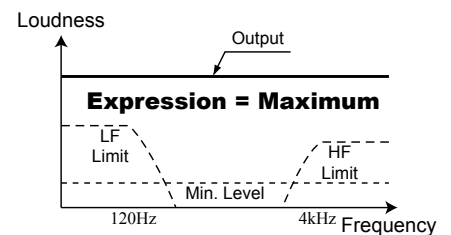

NOTE: The parameter with (P) indicated is a Patch parameter, and is recorded to each Patch. (G) indicates "global parameter", which is recorded upon being set, and is common with each Patch.

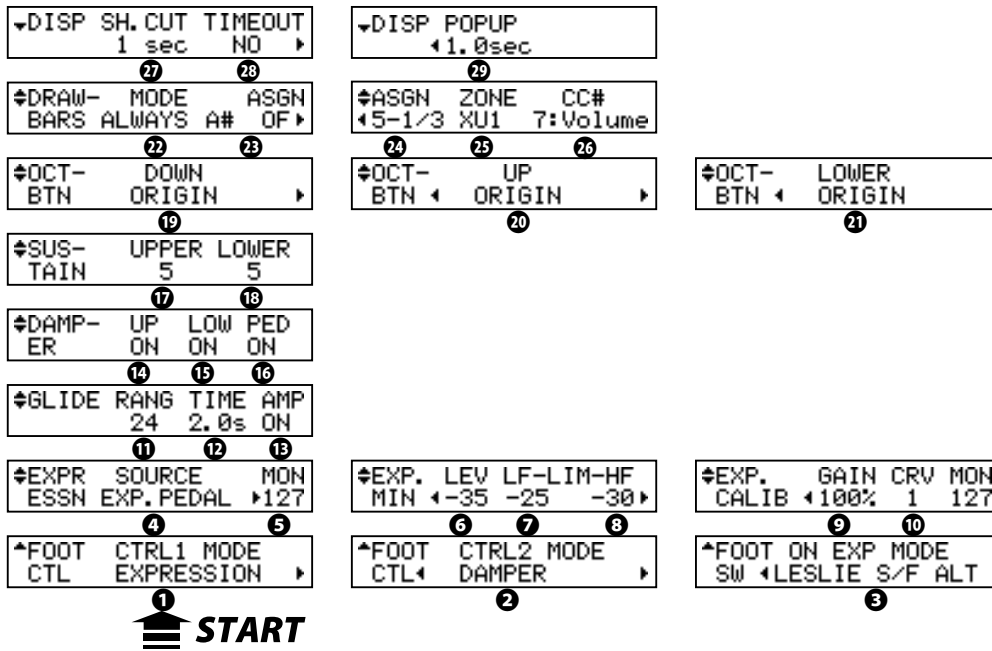

◆ **DAMPER**

14, 15, 16, DAMPER - UPPER (G), LOWER(G), PEDAL(G)

Assigns the DAMPER to the various divisions of the this keyboard, when the function of the foot controller is set at DAMPER.

◆ **SUSTAIN**

17, 18 SUSTAIN LENGTH - UPPER (P), LOWER(P)

Sets the release rate each part, when the function of the foot controller is set at SUSTAIN.

The setting range is 0(short) to 5(long).

NOTE: The key-click on the key released does not sound during Sustain is working.

◆ **ASSIGN**

19, 20, 21 OCTAVE BUTTON - DOWN (G), UP(G), LOWER(G)

Used to assign extra functions other than the original ones to the [OCTAVE] buttons.

- ORIGIN**.....Works according to the buttons' original function.
- LES STOP, LES FAST**Similar to the [LESLIE STOP], [LESLIE FAST] buttons.
- VIB UPPER, VIB LOWER**.....Similar to the [VIBRATO UPPER], [VIBRATO LOWER] buttons.
- GLIDE**.....This is for activating the Glide function.
- SPRING**.....This is for producing the shock noise of the Spring Reverb.
- DELAY TIME**.....Sets the Delay Time (P. 111) by tapping the button at the speed you wish the delay to be set. If you keep pressing the button, the Delay sound disappears.

◆ **DRAWBARS**

22 CONTROL MODE (S)

This is for switching the relationship between the Manual Keyboard Drawbars and the Registrations.

- A#/B**.....Each operation of the Drawbars [A#] and [B] affects only the corresponding Adjust Presets [A#] and [B]. The Drawbar operation is not effective when the Preset Keys [C] -- [A] are selected, or when the Patches are selected with the [VALUE] knob.
- ALWAYS A#**.....The operation of the Drawbar [B] is effective when the Preset Key [B] is selected. Otherwise, the Drawbar [A#] operation is always effective.

tips DAMPER

Or "Sustain" pedal-analogous to the RIGHT pedal on a piano. Sounds are held when this pedal is depressed. Called "Damper" due to the fact that when the pedal was depressed on a piano, the mechanism that muted or "damped" the strings was raised, allowing the piano strings to ring free.

tips SUSTAIN

Unlike synthesizer nomenclature, on the this keyboard "Sustain" refers to note decay after note release. On a synth envelope generator this setting would be called "T4" or "Release".

tips APPLICATION OF CONTROL MODE

A#/B:
First prepare the Registration for chorus with the Drawbar [A#], playing verse with the [B] Preset Key, then make a sudden timbre change by pressing the [A#] Preset Key upon entering chorus.

ALWAYS A#:
In addition to above, the following operation is possible:
To gradually change the Registration with the Drawbar [A#], playing with the recalled Patches with the Preset Keys [C] -- [A], or the [VALUE] knob.

23 ASSIGNABLE DRAWBARS (S)

This is for switching whether or not to use the LOWER [B] Drawbar as an assignable Drawbar.

In OFF the Drawbar [B] moves normally, and in ON it acts as an assignable Drawbar.

24 ASSIGN - FOOTAGE (S)

This is for selecting the footage to assign, when the LOWER [B] Drawbar is set as the Assignable Drawbar.

Footage selection is made not only with the [VALUE] knob but also by moving each footage of the Drawbar group [B]

25 ASSIGN - EXTERNAL ZONE (G)

This is for setting the External Zone corresponding with the footage selected in 24.

26 ASSIGN - CONTROL CHANGE NUMBER (G)

This is for setting the control change number corresponding with the footage selected in 24.

The setting range is 1:MOD -- 95:PHASER (Nothing to do with the built-in phaser in this keyboard).

tips ASSIGNABLE DRAWBARS

This keyboard can control the external MIDI equipment using the External Zone (P. 126). In that case, the function to use the LOWER [B] Drawbar as the controller for sending various control changes is called "ASSIGNABLE DRAWBAR".

The registration is adjusted with the Drawbar [A#] when the Preset Key [B] is selected while using the Assignable Drawbar.

◆ ACTIVE DRAWBARS

Mode 22	Assign 23	Preset Key		
		C C# D D# E F F# G G# A A# B	C C# D D# E F F# G G# A A# B	C C# D D# E F F# G G# A A# B
A#/B	Off			
Always A#	Off			
A#/B	On			
Always A#	On			

◆ DISPLAY

27 DISPLAY - SHORT CUT (G)

Sets the short cut waiting time.

The setting range is 0 to 2 seconds. At NO the short cut feature is disabled.

28 DISPLAY - TIME OUT (G)

Sets the time for returning to the previous mode from the mode displayed by the short cut operation.

The setting range is 4 to 16 seconds. At NO the screen will not return to the previous mode.

29 DISPLAY - POP UP (G)

Sets the interval at which the Pop Up is displayed when you move the [OVERDRIVE], [EFFECT] and [REVERB] knob.

The setting range is 0.5 to 2 seconds. At NO no Pop Up is displayed.

NOTE: The parameter with (P) indicated is a Patch parameter, and is recorded to each Patch. (G) indicates "global parameter", which is recorded upon being set, and is common with each Patch.

Column: EXPRESSION, LESLIE MODE

Expression and Leslie Mode are operable with plural means. Sometimes the status of a certain controller differs from the actual status.

This keyboard uses the value last operated as actual. (See “Last Event Priority” in the figure below.)

The actual status of Expression and Leslie Mode is checked on the EXPRESSION MONITOR in the CONTROL function mode and with the lamp of the LESLIE buttons in the left end block, respectively.

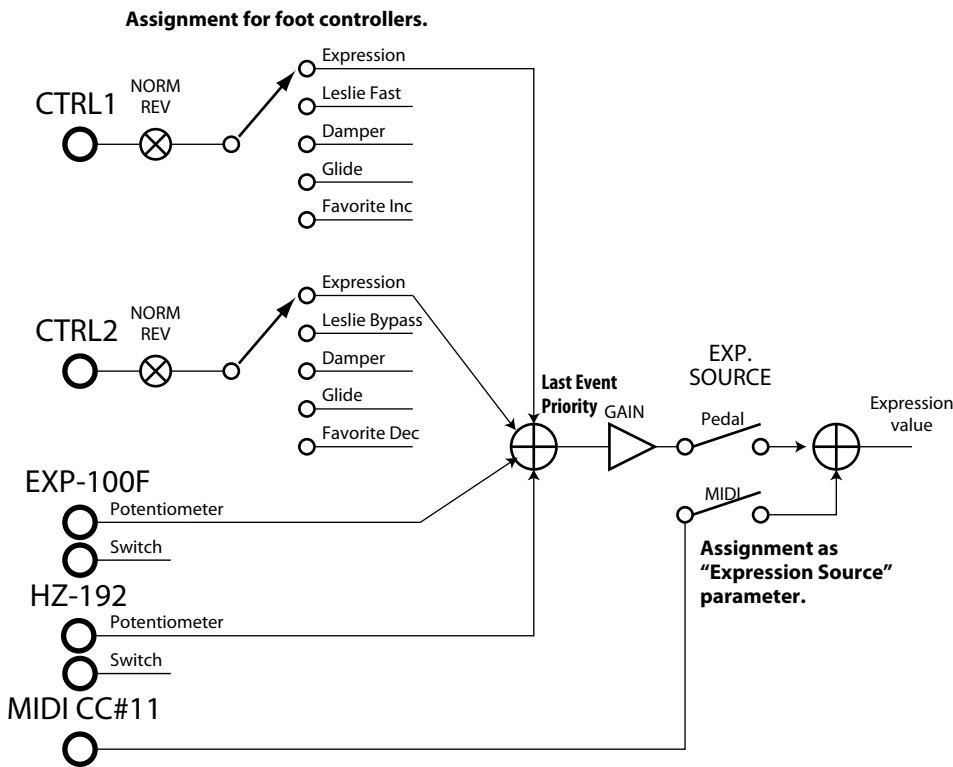

◆ ACTIVATE EXPRESSION PEDAL

For example, to activate the EXP-50J/20 Expression Pedal connected to the CTRL2 jack: set the POLARITY switch at NORM, CONTROL - CTRL2 MODE at “EXPRESSION” and then the EXPRESSION - SOURCE at “EXP. PEDAL” or “BOTH”.

In this mode, the entire keyboard is tuned.

◆ **To locate this mode:**



See "Function mode" (P. 68) for operation details.

TUNE MASTER
 A=440



◆ **MASTER TUNE**

① **MASTER TUNE**

This is for tuning the entire keyboard.

The setting range is A = 430 to 450 Hz.

NOTE: Master Tune is a global parameter. It is recorded when it is set, and is common for each patch.

PERCUSS (Percussion)

This mode is for setting the parameters of the Percussion sounds.

◆ **To locate this mode:**

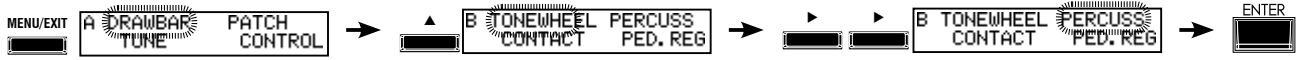

Or, holding the either of the [ON], [THIRD], [FAST], [SOFT] buttons for a moment.

See “Function mode” (P. 68) for operation details.

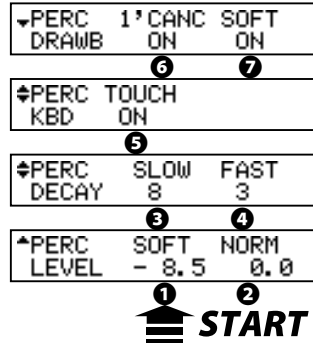

1 LEVEL SOFT

2 LEVEL - NORMAL

Controls the percussion volume levels. The Normal level is set by the NORM setting, and SOFT is the level when the [SOFT] button is ON.

The setting range is -22.0 to +10.5 dB.

3 DECAY - SLOW

4 DECAY - FAST

Controls the percussion decay time. The Slow rate is set by SLOW setting, and FAST is the time when the [FAST] button is ON.

The setting range is 1 to 24 and C. As the value is raised, the decay time grows longer. At C (continuous) there is no decay, and the percussion sound is sustained while keys are pressed.

5 KEYBOARD - TOUCH

Sets the touch response of the percussion.

- ON:** Legato playing will result in the First note hit engaging the percussion, and none after.
- OFF:** The envelopes reset with each key hit and percussion sounds on every note.

6 DRAWBAR - 1' CANCEL

Mutes the UPPER 1' Drawbar while using the percussion.

- ON:** Mute active
- OFF:** No mute.

7 DRAWBAR - SOFT

Reduces the UPPER Drawbar volume while using the percussion (except [SOFT] button is ON).

- ON:** Reduces the volume in similar response to the classic B-3/C-3.
- OFF:** Does not reduce the volume.

NOTE: All the parameters of these modes are Patch parameters, and are recorded to the respective Patches.

tips TOUCH

The percussion generator on the B-3/C-3 had a single envelope, which would not recycle until all keys were raised. Originally thought to be a defect, the resulting response became a desired trait.

tips 1' CANCEL

The B-3/C-3 had no exclusive key contact for the percussion, but, used the 1' contact. This is simulated on this keyboard.

tips DRAWBAR LEVEL

When the percussion was activated on the B-3/C-3, the volume of the Drawbars became slightly softer in volume. This is simulated on this keyboard.

NOTE: All the parameters in these pages are Patch Parameters. They are recorded into the Patch.

In this mode, the settings specific to Vibrato & Chorus are adjusted.

◆ **To locate this mode:**

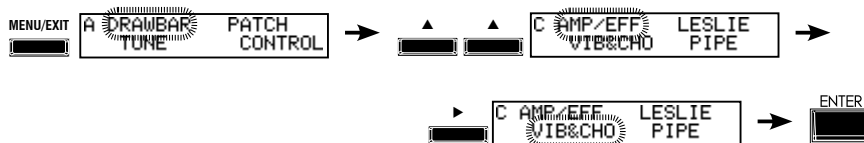

or, keep pressing either of the [ON UPPER], [ON LOWER] buttons for a few seconds. See “Function mode” (P. 68) for operation details.

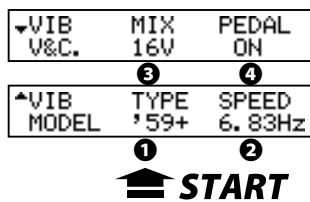

1 TYPE

Selects the type of the virtual vibrato equipment.

- '55-57: Metal Box (1955 - 1957)
- '57-59: Big Silver Box (1957 - 1959)
- '59+: Small Silver Box (1959 or later)

2 SPEED

Sets the Speed of the Vibrato and Chorus effect.
The setting range is 5.78 - 7.90 Hz (347 - 474 rpm).

3 MIX

Sets Mix balance of the Chorus effect (C1 / C2 / C3).
The setting range is D64 (only the Direct tone, no vibrato tone) - EVEN - 63V (only the Vibrato tone, no direct tone).

4 PEDAL

Sets Vibrato and Chorus on the Pedal part by [LOWER] button.
The setting range is ON/OFF.

tips VIBRATO TYPE

Hammond tone-wheel organs with Vibrato & Chorus were manufactured from 1949 through 1975. During that time, several different types of vibrato circuits were employed, particularly line boxes of different constructions. The Vibrato TYPE feature simulates the effect of different types of Vibrato delay lines.

tips PEDAL

On the B-3/C-3, the Vibrato and Chorus affects not only Lower part but also the Pedal part via [LOWER] (on the B-3/C-3, "GREAT") tablet by the circuit structure. It is divided on later models.
This parameter simulates that.

NOTE: All the parameters in these pages are Patch Parameters. They are recorded into the Patch.

LESLIE

In this mode, the settings are made for the on-board Leslie Effect and the External Leslie Speaker.

There are many parameters related to the Leslie effect, but they cannot set each parameter every Patch by Patch.

The on-board Leslie parameters are grouped in macro-settings called "CABINETS". You select the CABINET NUMBER in the Patches where this selection is saved as part of the Patch.

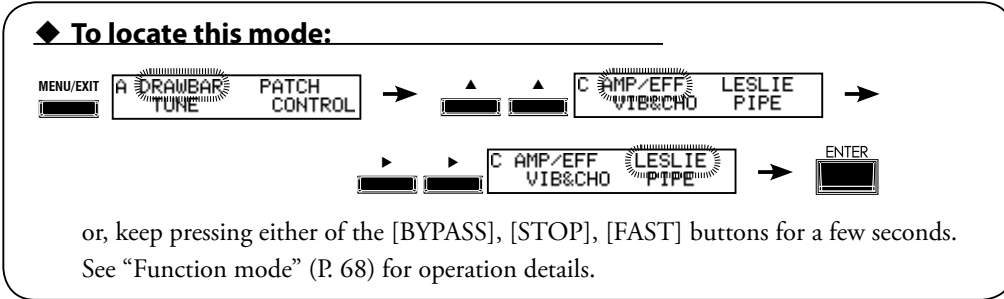

EXT. LESLIE CH 3		
LEVEL SUB DRUM HORN - 6 - 2 - 2		
DRUM SLOW FAST SPD 36 393	DRUM RIS FAL BRK DL TIME 7.5 5 10.5 .2	DRUM WIDT CNTR DIST MIC 40 +10 60
HORN SLOW FAST SPD 36 393	HORN RIS FAL BRK DL TIME 2.2 1 1.6 .2	HORN WIDT CNTR DIST MIC 40 -10 90
MODEL SPEAKER 122		
CUSTOM CAB NAME 122Jazz		
CUSTOM CAB NUMBER U1:122 Jazz		

START

◆ CABINET NUMBER

① CABINET NUMBER (P)

Selects the Cabinet Number to use in the Patch.

The setting range is F1 to F8 (not-overwritable) and U1 to U8 (overwritable). If any of the Leslie parameter are edited, "*" is displayed on the left side.

◆ LESLIE PARAMETERS

② CABINET NAME (L)

Sets the Cabinet Name by up to 10 characters.

Move the cursor with the [◀][▶] button and select letters with the [VALUE] knob. Allowable values are: symbols, digits and the large and small Alphabet.

The name and following (L) parameters are not recorded until the Cabinet Macro is recorded into memory (See the next paragraph.)

③ SPEAKER (L)

Selects the virtual speaker type.

See appendix for details.

④ / ⑤ SLOW SPEED - HORN / DRUM (L)

Sets the rotor speed on the Slow mode.

The setting range is 0(no rotate), 20 to 120 rpm.

tips

CONCEPT OF THE CABINET NUMBER

One Cabinet is equivalent to a virtual Leslie speaker made with the Leslie parameter. This is a Patch parameter only in these function pages.

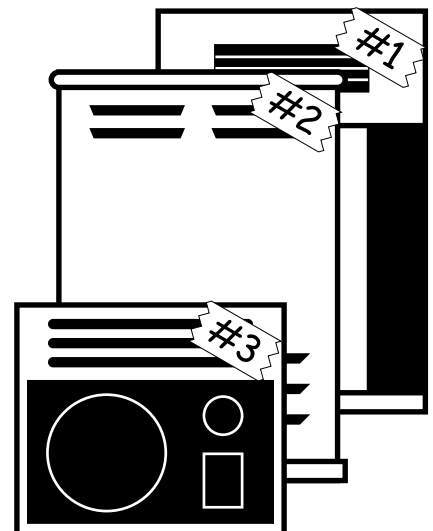

5 / 14 FAST SPEED - HORN / DRUM (L)

Sets the rotor speed on the Fast mode.

The setting range is 0, 200 to 500 rpm.

6 / 15 RISE TIME - HORN / DRUM (L)

Sets the time for the rotors to “ramp up” to the ‘Fast Speed’, when switching from ‘Slow’ or ‘Stop’ to the ‘Fast’ mode.

The setting range for the Horn rotor is 0.8 to 12.5 sec., and the Drum rotor is 1.0 to 12.5 sec.

7 / 16 FALL TIME - HORN / DRUM (L)

Sets the time for the rotor to reach the ‘Slow Speed’, when switching from ‘Fast’ to ‘Slow’ mode.

The setting range for the Horn rotor is 0.8 to 12.5 sec., and the Drum rotor is 1.0 to 12.5 sec.

8 / 17 BRAKE TIME - HORN / DRUM (L)

Sets the time for the rotor to stop, when switching from ‘Fast’ to the ‘Stop’ mode.

The setting range for the Horn rotor is 0.8 to 12.5 sec., and the Drum rotor is 1.0 to 12.5 sec.

9 / 18 DELAY TIME - HORN / DRUM (L)

These are for setting the time to actually start changing the speed, when the mode is switched.

The setting range is 0 to 1.0 sec.

10 / 19 MIC WIDTH - HORN / DRUM (L)

These are the parameters for setting the Virtual Leslie Speaker at which location the Microphones should be placed.

Width sets the distance between the left and the right microphones. The setting range is 0 to 40. The value increases makes wider stereophonic. At 0, mono.

11 / 20 MIC CENTER - HORN / DRUM (L)

Sets the offset between center of two microphones and pivot of the rotor.

The setting range is -50 to +50 cm. The virtual Leslie speaker turns counter clockwise for Horn rotor, and clockwise for Drum rotor. To emphasize the ‘upcoming’, set the ‘+’ value for Horn rotor, and ‘-’ value for Drum rotor.

12 / 21 MIC DISTANCE - HORN / DRUM (L)

These are for setting the distance between the Virtual Leslie Speaker and the microphones.

The setting range is 30 to 200 cm. The value decreases makes deeper effect.

22 / 23 / 24 LEVEL - SUB BASS / DRUM / HORN (L)

Sets the volume levels of the each rotor and the sub bass sound not modulated with the Drum rotor.

The setting range is -INF(silent), -76 to 0 dB.

NOTE: The parameters #2 to #24 are Leslie parameters. These are common for same Custom Cabinet of each Patch.

NOTE: After editing, you must record your changes to save them (Procedure following).

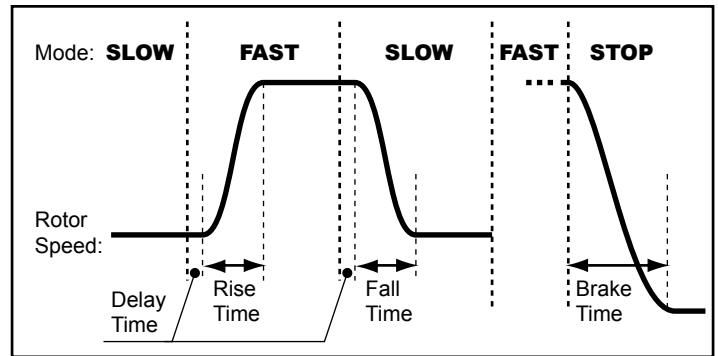
**tips STANDARD TIME**

It is different that time to completely changed each Leslie Mode by its speed.

In this keyboard, the time is displayed which based changing from 40 rpm to 400 rpm.

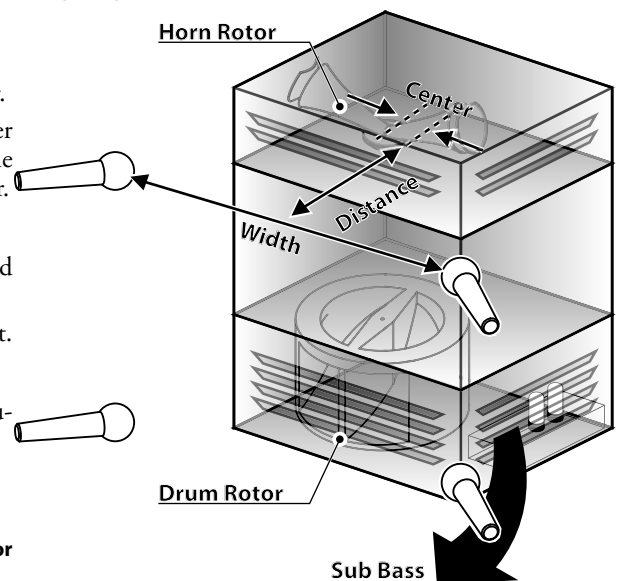

◆ EXTERNAL LESLIE SPEAKER

25 LESLIE CHANNELS

Sets the channel for the Leslie speaker connected to the LESLIE 11-PIN jack.

1ch: For connecting a 1 channel Leslie cabinet such as the #981/#3300/#122XB. The Drawbar and the percussion sounds are output only from the rotary channel always.

3ch: This is for connecting a 3 channel Leslie cabinet such as the #2101/#2101mk2, 3300/3300W (with stationary speakers). The Drawbar and the percussion sounds are output from the rotary channel, bypassed Drawbar and percussion sounds are from the stationary channel of the Left (or Main) and Right (or Aux, Sub, Animation).

1+LINE:

For connecting both 1 channel Leslie cabinet and stationary speaker system on the LINE OUT jack. The Drawbar and the percussion sounds are output from the rotary channel, bypassed Drawbar and percussion sounds are from the stationary channel of the Left and Right.

NOTE: This is a system parameter. It is recorded upon setting, and is common with all patches.

Ch. Option	Leslie 11 Pin	Line Out
1	for FOH	for Monitor
1+LINE	Rotary	Stationary

RECORD THE CUSTOM CABINET

Record the Leslie parameter (2 to 24 on the previous page) to the Custom Cabinet numbers and use them selecting at the Patches.

1 ENTER THE NAME



Enter a name to the cabinet as desired.

2 LOCATE THE RECORD MODE

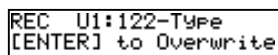
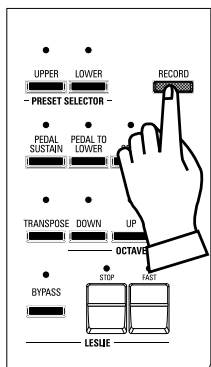

Press the [RECORD] button in the Leslie parameter pages (#2 to #24).

The Custom Cabinet number Select mode is displayed.

3 SELECT THE NUMBER TO RECORD

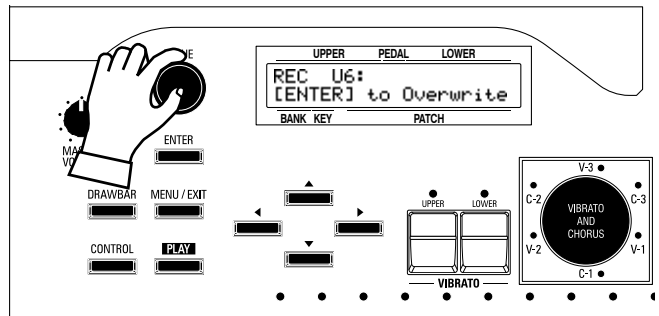

Select the Custom Cabinet number to record with the [VALUE] knob.

4 PRESS [ENTER] TO DECIDE

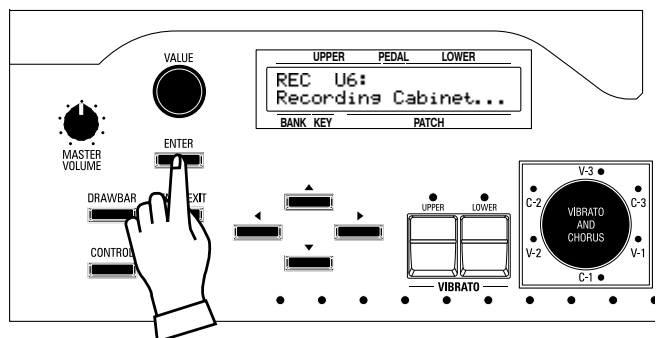

Press [ENTER] to record the Custom Cabinet.

The display is as the above during the treatment.

NOTE: If you don't wish to record, touch the [MENU/EXIT] button.

In this mode, you select or edit the characteristics of each Tone Wheel set.

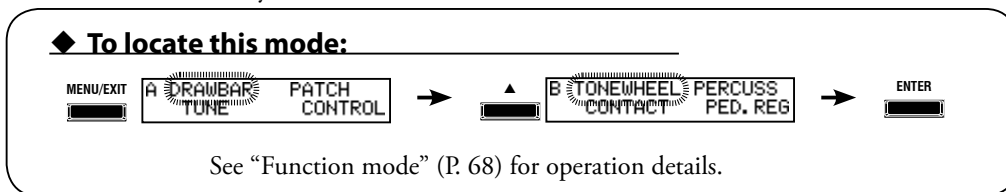

▼FOOTAGE NOTE M. LEV
5-1/3 3C# -10.0

⑩ ⑪ ⑫

⇄WHEEL WHEEL-LKG-LEV
F02:1C# 91:8F# -10.5

④ ⑧ ⑨

⇄WHEEL LEVEL HPF
F02:1C# -10.5dB 0▶

④ ⑤ ⑥

⇄CUSTOM TW NAME
Real_B-3

③

⇄CUSTOM TW NUMBER
U1:Real B-3

②

▲TONE WHEEL
B-3

① **START**

⇄WHEEL LEAK TRIM
F02:1C# 127

⑦

tips WHAT ARE CUSTOM TONE WHEELS?

On the Tone Wheel organ (ex. "B-3") the Tone Wheel set consists of 96 tone wheels (hereinafter "wheels"), and a wheel correspond with plural notes and the Drawbar footage. The relationship is complicated. For example, the middle "C" of 8' and the "C" one octave lower of 4' use the same wheel. On the B-3/C-3 the volume or the "leak" of each wheel differs unit by unit. It is widely recognized as a desired characteristic. On this keyboard the volume or the "leak" of each wheel can be edited, and 3 types of settings can be saved per each tone wheel set.

1 ORGAN TYPE

Selects the organ type to edit: "A-100", "B-3", "C-3" and "Mellow". Also, the temporary (= the present setting) automatically switches to the selected organ type just selected now.

2 CUSTOM NUMBER (P)

This is for selecting the "CUSTOM NUMBER" to use or compile. The setting range is F1 to F3 (not re-writable) and U1 to U3 (re-writable). See right tree for detail. The symbol "*" will be displayed when the virtual Tone Wheel parameters (TW) are edited.

NOTE: This parameter is a Patch parameter only in this function pages. It is recorded into the Patch.

3 CUSTOM NAME (TW)

Enter the Custom Tone Wheels set name using up to 10 letters. Move the cursor by the [◀] [▶] button and choose the letters by the [VALUE] knob.

NOTE: The name set here, as well as the Tone Wheel parameters below, will be discarded, if not recorded (procedure following).

4 WHEEL NUMBER (TW)

Select the number of the Tone Wheel you want to regulate. The setting range is displayed by "wheel# : note" style,
01: 0C to 12: 0B,
F01: 0C to F12: 0B,
13: 1C to 91: 8F# and
F92: 8G to F96: 8B.

"F" means the wheel used for extended fold-back. The non-marked Wheel Number means original wheel from B-3/C-3.

To select the Wheel Number, select the [VALUE] knob here, or slightly move the footage of the Drawbar while depressing the key you want to regulate (see the illustration on the right).

When the Wheel Number is selected, each parameter for the wheel (5 to 12) is updated.

NOTE: Set the [TRANSPOSE] and [OCTAVE] at "0" to select a correct wheel.

Custom Tone Wheels

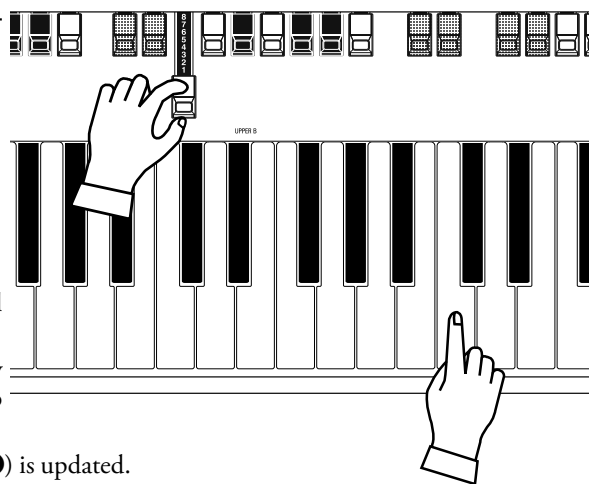
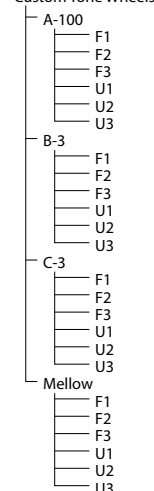

How to select the WHEEL NUMBER

90 TONEWHEEL (Custom Tone Wheels) - continued

FOOTAGE NOTE M. LEV 5-1/3 3C# -10.0		
10	11	12
WHEEL WHEL-LKG-LEV F02:1C# 91:8F# -10.5		
4	3	9
WHEEL LEVEL HPF F02:1C# -10.5dB 0		
4	5	6
CUSTOM TW NAME Real_B-3		
CUSTOM TW NUMBER U1:Real B-3		
TONE WHEEL B-3		

START

5 LEVEL (TW)

This is for setting the volume of this wheel.
The setting range is -INF (off), -73 (quiet) to +4 (loud) dB.

6 CUT OFF FREQUENCY - HPF (TW)

This is for setting the frequency to cut the bass of the wheel.
If you decrease the value, a motor hum (=noise) is heard besides the original virtual Tone Wheel sound.
The setting range is 0 to 127.

7 LEAKAGE TONE TRIMMER (TW)

Adjusts all the level of the Leakage tones which related Fundamental tone.
The setting range is 0 to 127.

8 LEAKAGE WHEEL NUMBER (TW)

Selects which wheel "leaks" onto the Fundamental by using 61:6C to 91:8F# "Leakage Wheel" for each 01:0C to 72:6B "Fundamental Wheel" (right figure).
This parameter selects the Leakage Wheel which sounds together with Fundamental Wheel 4.

To select the Leakage Wheel, use the [VALUE] knob or move the desired footage of the Drawbars with pressing the key to edit.

9 LEAKAGE WHEEL LEVEL (TW)

Adjusts the volume of the selected Leakage Wheel.
The setting range is -INF (off), -73 (quiet) to +4 (loud) dB. The volume may become limited as the value is raised.

10, 11 MATRIX - FOOTAGE, NOTE (TW)

Selects "Matrix" to adjust the level which desired each footage and each note.

12 MATRIX - LEVEL (TW)

Adjusts the level which chosen above matrix.
The setting range is -INF (off), -73 (quiet) to +4 (loud) dB.

NOTE: The parameters #3 to #12 are Tone Wheel parameters. These are common for same Custom Tone Wheel set of each Patch (in this example, U1 of "B-3").

NOTE: After editing, you must record your changes to save them (Procedure following).

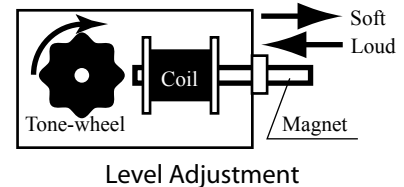

tips dB, DECIBEL

The word "dB" or "decibel" is a unit for scaling the signal level. For example, 0dB means unity, +6dB means twice, and -6dB means half approximately.

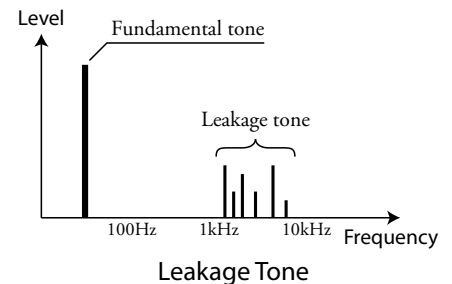

tips WHEEL NUMBER "F"

These wheels have the same pitch but different timbre between Tone Wheel F01 and 01 (below figure).

There are 91 wheels which sound on the B-3/C-3. XK-5 has 96 wheels by adding 12 + 5 wheels to extend the fold back (F01 to F12, F92 to F96).

The true #1 to #12 Tone Wheels provide the characteristic timbre for the Pedal part, although they are not good for manual part. These are called "Complex Tone Wheels".

uses special wheels
 uses original wheels

Manual: F01 F12 13 91 F92 F96
Pedal: 01 12 common with manual parts

Used Tone Wheels on each part

RECORD THE CUSTOM TONE WHEELS

The Tone Wheel parameters (= ❸ to ❹ of the previous page) are for determining the Custom Number for recording. The Custom Number is selected and used, when you play.

❶ ENTER THE NAME

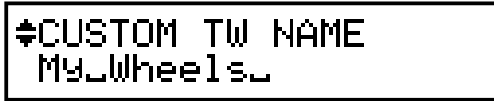

Enter the Custom Name if necessary.

❷ LOCATE THE RECORD MODE

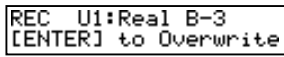
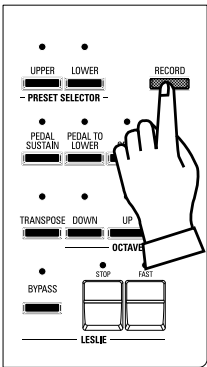

Press the [RECORD] button at any page for Tone Wheel parameters (❸ to ❹).

The display locates the page for selecting the Custom Number to record.

❸ SELECT THE NUMBER TO RECORD

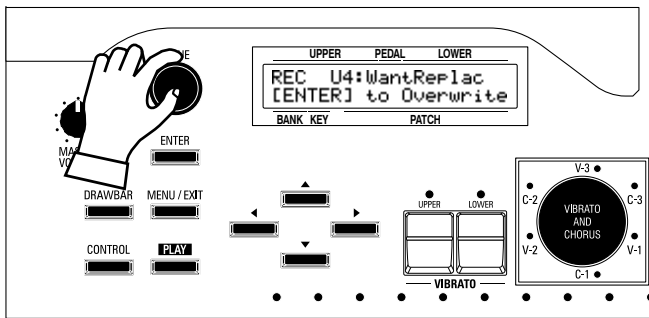

Select the Custom Number by [VALUE] knob.

❹ PRESS [ENTER] TO DECIDE

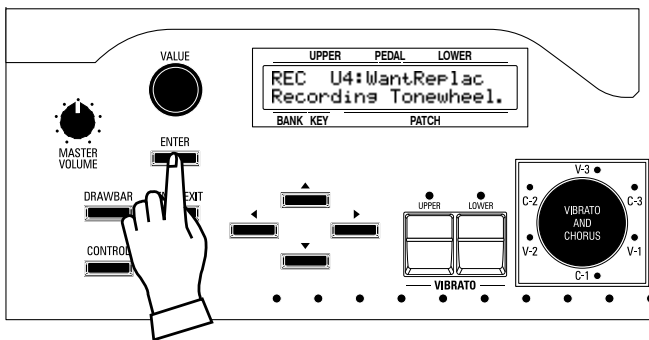

Press [ENTER] to record.

The display shows as left figure during recording.

NOTE: To dismiss the record sequence, touch the [MENU/EXIT] button.

CONTACT

In this function mode, selects and edits the each contact set of the manual keyboards.

◆ **To locate this mode:**

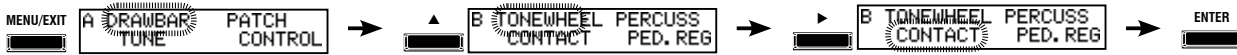

See "Function mode" (P. 68) for operation details.

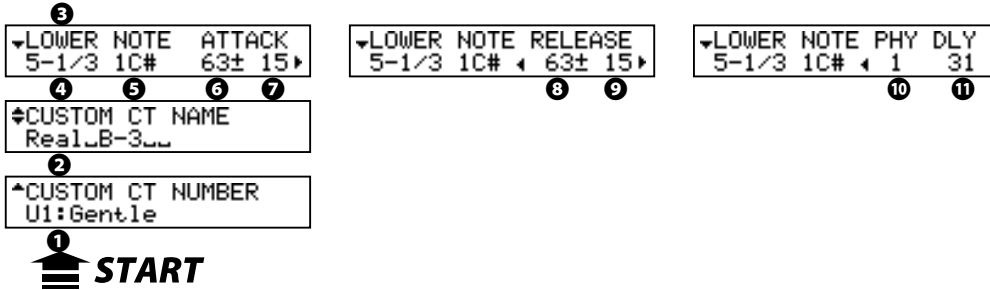

tips WHAT ARE CUSTOM CONTACTS?

To sound or mute, a device called "MULTI-CONTACT" is used on the B-3/C-3's keyboard. To each note on the keyboard, 9 types of tonal signals come from the Tone Wheels corresponding with the harmonics (ref. P.44), each of which is connected or cut off with 9 contacts. The depth of each contact differs one by one. And, if the surface of the contact gets stained or if it bounds at the time of contact, it causes a noise so-called "CHATTERING". The so-commonly-called "KEY CLICK" on the Hammond Organs is due to such complicated phenomena combined. The contact depth and the time for the perfect touch can be edited and recorded upto 3 types of settings on this keyboard. It is called "CUSTOM CONTACT".

To activate the Custom Contact, set the Organ type in the Drawbar Function mode at either of "A-100", "B-3", "C-3", "Mellow", and the Envelope at "Con tact)". (P. 74)

❶ **CUSTOM NUMBER (P)**

This is for selecting the "CUSTOM NUMBER" to use or compile. The setting range is F1 to F3 (not re-writable) and U1 to U3 (re-writable).

The symbol "*" will be displayed when the Contact parameters are edited.

NOTE: This parameter is a Patch parameter only in this function pages. It is recorded into the Patch.

❷ **CUSTOM NAME (CT)**

Enters name the Custom Contacts set using up to 10 letters.

Move the cursor by the [◀] [▶] button and choose the letters by the [VALUE] knob.

NOTE: The name set here, as well as the contact parameters below, will be discarded, if not recorded (procedure following).

◆ **SELECT CONTACT**

❸ **CONTACT - PART**

❹ **CONTACT - FOOTAGE**

❺ **CONTACT - NOTE**

Selects the virtual contact to adjust by "Part", "Footage" and "Note".

To select the virtual contact, use [VALUE] knob or, slightly move the footage of the Drawbar while depressing the key you want to regulate (see the illustration on the right).

To adjust all the footages or notes at same time, set the cursor on the footage or NOTE, turn [VALUE] knob clockwise at maximum it displays "ALL" instead a number.

When the Contact is selected, each parameter for the wheel (#6, to #11) is displayed.

NOTE: Set the [TRANPOSE] and [OCTAVE] at "0" to select a correct contact.

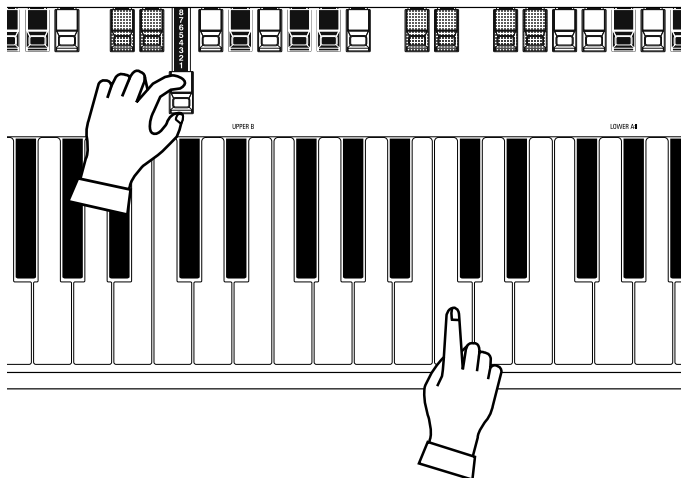

How to select a contact

◆ CONDITION

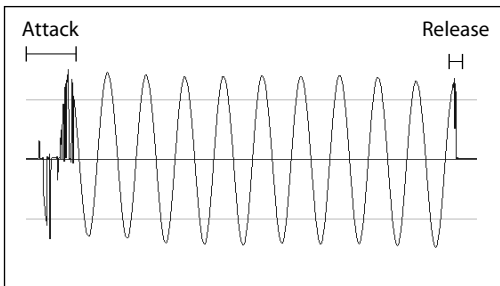

⑥ ATTACK TIME - CENTER (CT)

⑦ ATTACK TIME - VARIATION (CT)

Sets the time when the note is on to until virtual contact is connected completely.

Set the center value by #6, how vary with press by press by #7.

The setting range is 0(short) to 127(long). The longer value makes harsh contact.

⑧ RELEASE RATE - CENTER (CT)

⑨ RELEASE RATE - VARIATION (CT)

Sets the time when the note is off to until virtual contact is released completely.

Set the center value by #8, how vary with press by press by #9.

The setting range is 0(short) to 127(long).

NOTE: Attack of the virtual contact has bouncing/chattering. But Release of the virtual contact has less bouncing/chattering.

◆ PHYSICAL CONTACT

⑩ PHYSICAL CONTACT - NUMBER (CT)

This is for selecting at which physical contact number to sound the selected Virtual Contact on the keyboard of the XK-5 or XLK-5.

The setting value is 1--3. The larger the value is, the key sounds at the deeper point.

NOTE: This value is disregarded on the PEDAL part. Because the pedalboards such as XPK-250W has only a physical contact.

⑪ PHYSICAL CONTACT - DELAY (CT)

This is for setting how the Virtual Contact delays after the physical contact is made.

The setting value is 0 -- 800 ms. The larger the value is, the longer time it takes.

tips WHY LESS RELEASE KEY CLICK?

When you clap and hold the hands, you can hear the loud sound. But when you release the hands, it does not.

The leaf contacts of the B-3/C-3 like this.

The attack rate is longer, you can hear the "noisy" bouncing. But the release rate is longer, the envelope will smoother, and it makes "soft" release key click.

NOTE: After editing, you must record your changes to save them (Procedure following).

RECORD THE CUSTOM CONTACTS

The Contact parameters (= 2 - 11 of the previous page) are for determining the Custom Number for recording. The Custom Number is selected and used, when you play.

1 ENTER THE NAME



Enter the Custom name if necessary.

2 LOCATE THE RECORD MODE

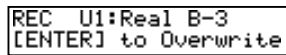
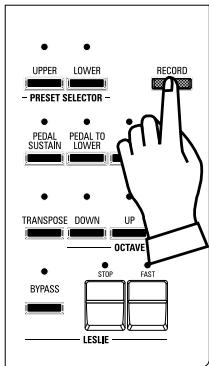

Press the [RECORD] button at any page for Contact parameters (2 to 11).

The display locates the page for selecting the Custom Number to record.

3 SELECT THE NUMBER TO RECORD

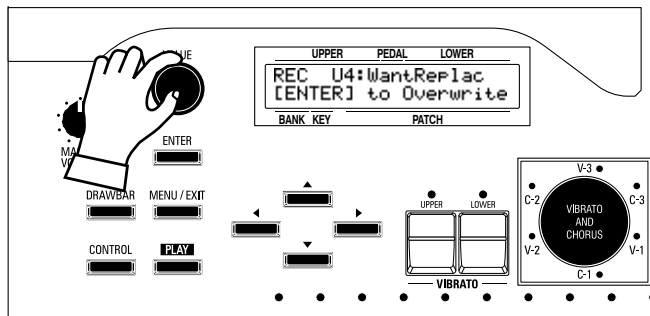

Select the Custom Number by [VALUE] knob.

4 PRESS [ENTER] TO DECIDE

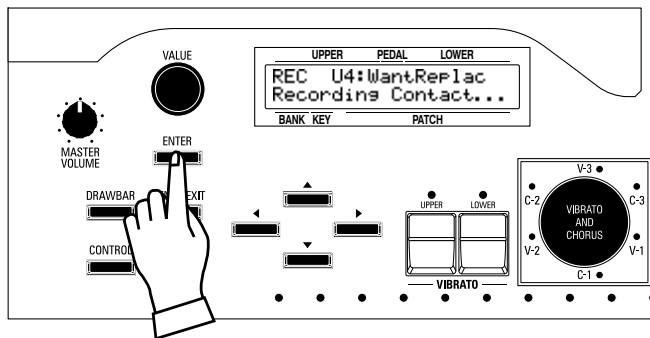

Press [ENTER] to record.

The display shows as left figure during recording.

NOTE: To dismiss the record sequence, touch the [MENU/EXIT] button.

Column: CONTACTS OF THE B-3/C-3 AND VIRTUAL CONTACTS

The flow of air on the wind instrument is actuated by breath. The sound of the Pipe Organ is actuated with the valves underneath the pipes.

◆ CONTACTS OF B-3/C-3

The sound flow of the B-3/C-3 is controlled by turning the tonal signals made with the Tone Wheels on and off.

When a key is pressed, the 9 contact springs (the horizontal bars in the figure on the right) connected with the actuators are pressed, too. Each contact spring is connected footage by footage to the Tone Wheels.

When the contact springs finally touch the Bus Bar (the small circle in the right figure), the tonal signals start running toward the Preset Keys or the Drawbars, which finally reach our ears.

The conditions of the contact springs are diversified. They touch perfectly mostly after several bounces. As the heights of the actuators and bus bars are uneven (not the same), all footages do not make sound at the same time.

The so-called “Key-Click” on Hammond Organs is due to the complication of these phenomena.

◆ VIRTUAL CONTACTS

The “VIRTUAL CONTACT KEYBOARD” on this unit reproduces these actions with the special keyboard and electronics.

3 physical contacts of 3 different depths exist on this keyboard.

You can set the following conditions of the contact springs and the Bus bars with each footage of each key:

- ◆ the conditions of the bounce or rust
- ◆ the depth of contact
- ◆ length of delay

of the contact springs and the Bus Bars with each footage of each key.

◆ PLAYING TECHNIQUES

Let us introduce the playing techniques possible when you use the “MULTI-CONTACTS”.

For obtaining these effects, the registrations with as many Drawbars pulled out as possible is effective.

1. CHORD STROKE

When repeatedly playing the chords, the dynamics are obtained by the pressure of the touch on the piano, and the intonation is obtained by “muting/releasing” the strings if on the guitar.

The sound intonation is obtained with the Multi-Contacts by deepening or shallowing the touch so making only some of them touch or all contacts touch.

2. ERROLL GARNER STYLE

When playing glissando, twist the wrist subtly, fluttering the palm, instead of strongly pressing down the key with the palm.

Then, the “ON/OFF” of each contact does change as if waving as the pitch changes and produces more complicated change of sound.

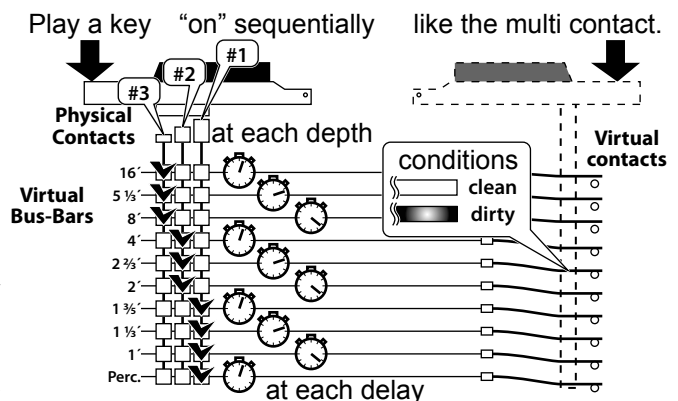

PED. REG (Pedal Registration Sub Drawbars)

In this function mode, selects and edits the “Sub Drawbars” of the Pedal part.

◆ **To locate this mode:**

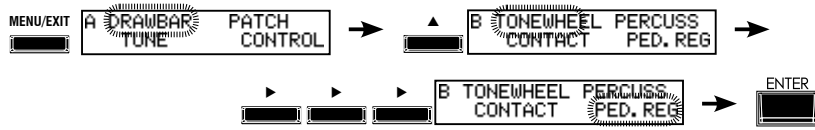

See “Function mode” (P. 68) for operation details.

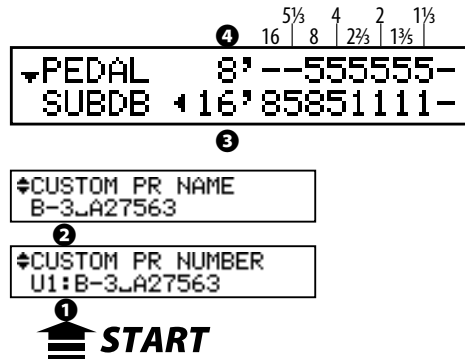

tips WHAT ARE SUB-DRAWBARS?

The Drawbars 8’ and 16’ of the B-3/C-3’s Pedal Keyboard are plural footages sounding with 1 bar, not like those of the manual keyboard. The degree how the volume of which footage is mixed to each Drawbar differs unit by unit depending on the time of production. (See below.) We call it “Sub-Drawbar” on XK-5. It can be freely edited and recorded.

The “Sub Drawbars” functions on the organ type “A-100”, “B-3”, “C-3” or “Mellow” for manual part, besides “Normal” for Pedal part.

It selected automatically if entered in this function mode.

1 CUSTOM NUMBER (P)

This is for selecting the Custom Number to use or compile. The setting range is F1 to F3 (not re-writable) and U1 to U3 (re-writable).

The symbol “*” will be displayed when the Pedal Registration parameters (PR) are edited.

NOTE: This parameter is a Patch parameter only in this function pages. It is recorded into the Patch.

2 CUSTOM NAME (PR)

Enters name the Pedal Registration set using up to 10 letters.

Move the cursor by the [◀] [▶] button and choose the letters by the [VALUE] knob.

NOTE: The name set here, as well as the Pedal Registration parameters below, will be discarded, if not recorded (procedure following).

3 SUB DRAWBAR - 16’ (PR)

Adjusts the harmonics of the Pedal Drawbar 16’.

Adjustable footages are 16’, 5½’, 8’, 4’, 2⅔’, 2’, 1⅓’, and 1/8’.

NOTE: The footages 2⅔’, 2’, 1⅓’ and 1/8’ in the Sub Drawbar 16’ has softer maximum volume than other footages for fine-adjustment.

4 SUB DRAWBAR - 8’ (PR)

Adjusts the harmonics of the Pedal Drawbar 8’.

Adjustable footages are 8’, 4’, 2⅔’, 2’, 1⅓’, and 1/8’.

NOTE: After editing, you must record your changes to save them (Procedure following).

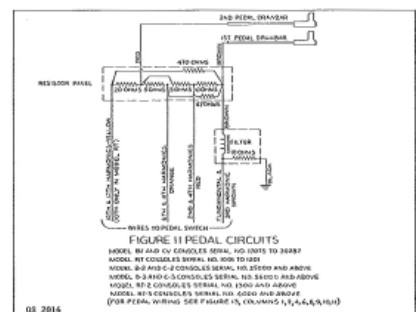
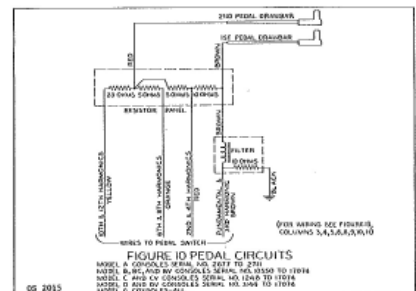
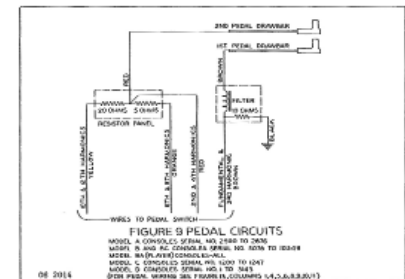
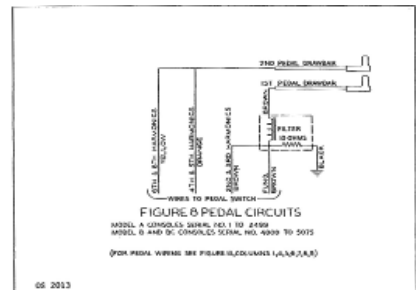

RECORD THE SUB DRAWBARS

The Pedal Registration parameters (= 2 - 4 of the previous page) are for determining the Custom Number for recording. The Custom Number is selected and used, when you play.

1 ENTER THE NAME



Enter the Custom name if necessary.

2 LOCATE THE RECORD MODE

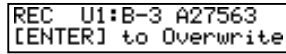
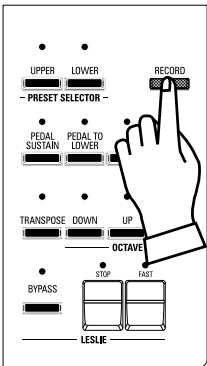

Press the [RECORD] button at any page for Pedal Registration parameters (2 to 4).

The display locates the page for selecting the Custom Number to record.

3 SELECT THE NUMBER TO RECORD

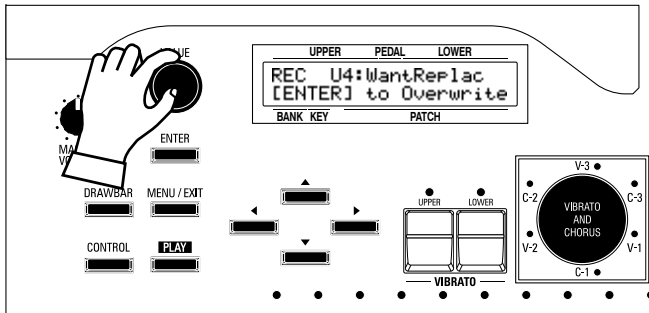

Select the Custom Number by [VALUE] knob.

4 PRESS [ENTER] TO DECIDE

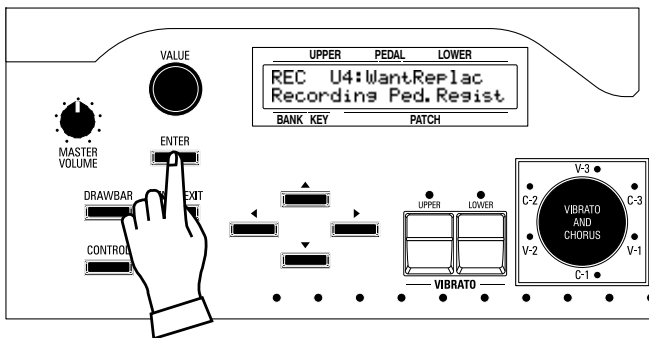

Press [ENTER] to record.

The display shows as left figure during recording.

NOTE: To dismiss the record sequence, touch the [MENU/EXIT] button.

PIPE

In this function mode, adjusts the characteristics of the each pipe stop which used on the organ type “Pipe”.

◆ To locate this mode:

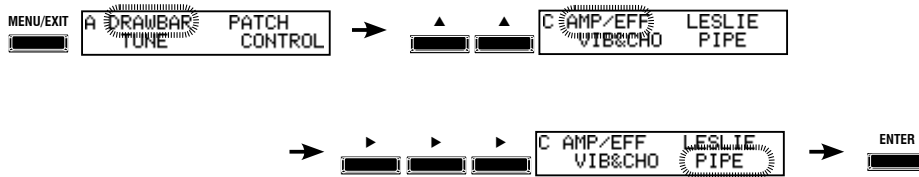

See “Function mode” (P. 68) for operation details.

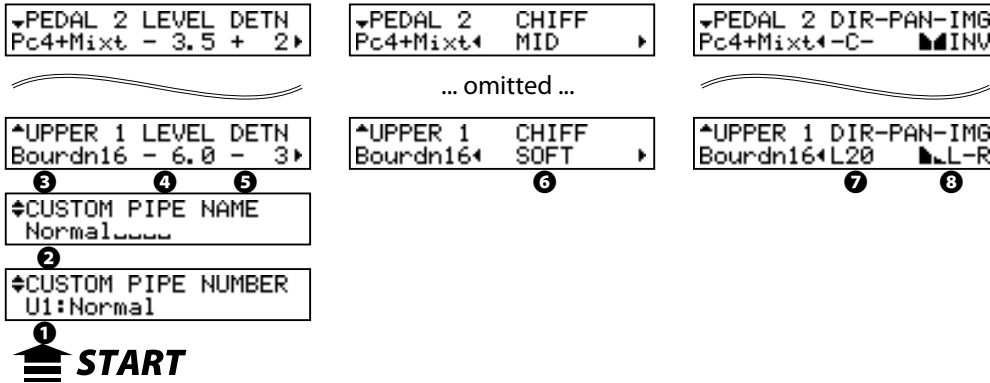

1 CUSTOM NUMBER (P)

This is for selecting the Custom Number to use or compile. The setting range is F1 to F3 (not re-writable) and U1 to U3 (re-writable).

The symbol “*” will be displayed when the Pipe parameters (Pi) are edited.

NOTE: This parameter is a Patch parameter only in this function pages. It is recorded into the Patch.

2 CUSTOM NAME (Pi)

Enters name the Custom Pipe set using up to 10 letters.

Move the cursor by the [◀] [▶] button and choose the letters by the [VALUE] knob.

NOTE: The name set here, as well as the Pipe parameters below, will be discarded, if not recorded (procedure following).

3 PIPE STOP

Select the Pipe Stop which you desire to edit by [▲],[▼] buttons or Drawbars which regarding with each pipe.

There are 20 pipes which according to Drawbars from “Bourdon 16” to “Principal Chorus 4’ + Mixture IV”.

4 LEVEL (Pi)

Adjusts the volume of the pipe. The setting range is -INF(quiet) to 0(loud).

5 DETUNE(Pi)

De-tunes the pitch of pipe from accurate pitch by cent ($\frac{1}{100}$ of semitones).

The setting range is -50(^b) - 0 - +50([#]).

6 CHIFF (Pi)

Sets the “Chiff” noise of beginning of notes.

OFF: No sounds the chiff noise.

SOFT: Sounds the chiff noise slightly.

MID: Sounds the chiff noise medium.

LOUD: Sounds the chiff noise maximum.

NOTE: Some pipes does not affect the chiff parameter i.e. “Hautbois 8”.

tips WHAT IS CUSTOM PIPES?

The pipe set of the pipe organ on this unit consists of 20 Pipe Stops.

You can edit the volume or pan of each pipe set and save 3 types of settings.

It is called “CUSTOM PIPES”.

tips DETUNE

If you add a sound in a slightly detuned pitch to a sound in a original correct pitch, it produce a beating effect.

All the pipes can be detuned, because a moderate beating gives a comfortable feeling. However, if you detune too much, it sounds really uncomfortably out of tune.

Generally, it is effective if you set the lower octave pipes to “-” and the higher octave pipes to “+”.

tips CHIFF

This is the first small sound of air heard in the beginning of the pipe sound.

7 PAN - DIRECTION (Pi)

Adjusts the basic direction of the pipe.

The setting range is L64 - C - R63 (Left - Center - Right).

8 PAN - IMAGING (Pi)

Sets the arrangement of the pipe.

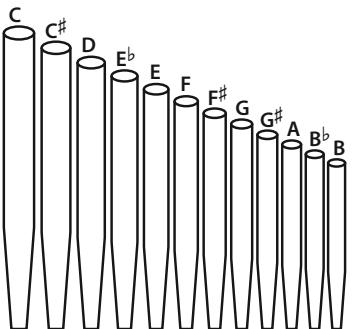
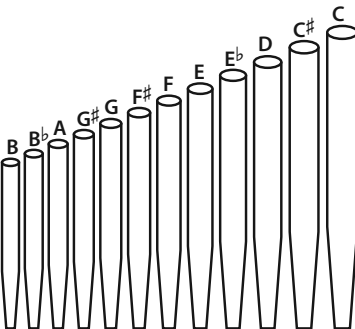
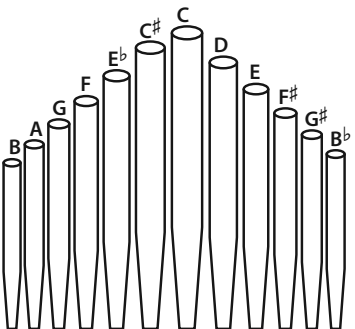
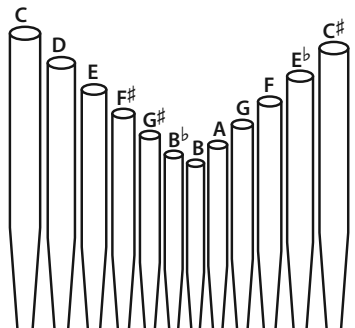
FIX	No image	Sounds the FIXEd direction which set by #7 for all notes.
L-R		Sounds Left to Right which according to the keys.
R-L		Sounds Right to Left which according to the keys.
PYR		Like the pyramid, sounds center to sides which according to the keys.
INV		Like the inverted pyramid, sounds sides to center which according to the keys.

NOTE: After editing, you must record your changes to save them (Procedure following).

RECORD THE CUSTOM PIPES

The Pipe parameters (= ❷ to ❸ of the previous page) are for determining the Custom Number for recording. The Custom Number is selected and used, when you play.

❶ ENTER THE NAME



Enter the Custom name if necessary.

❷ LOCATE THE RECORD MODE

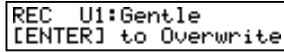
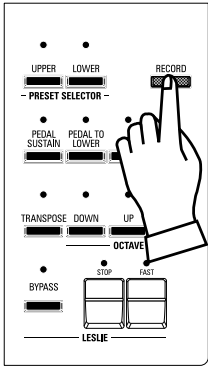

Press the [RECORD] button at any page for Pipe parameters (❷ to ❸).

The display locates the page for selecting the Custom Number to record.

❸ SELECT THE NUMBER TO RECORD

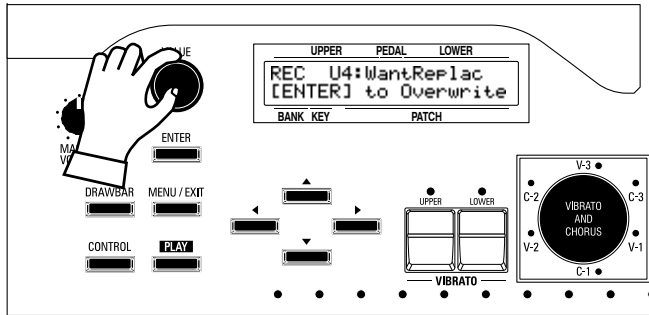

Select the Custom Number by [VALUE] knob.

❹ PRESS [ENTER] TO DECIDE

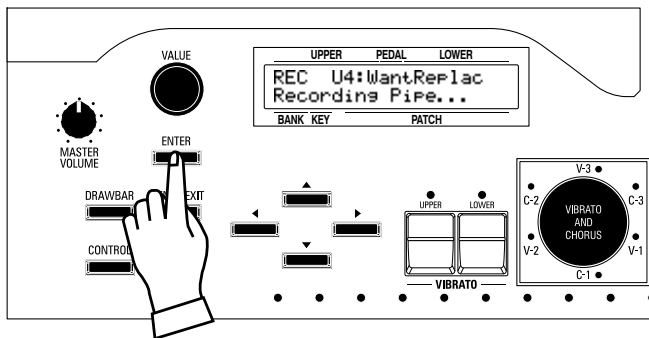

Press [ENTER] to record.

The display shows as left figure during recording.

NOTE: To dismiss the record sequence, touch the [MENU/EXIT] button.

In this function mode, sets the Pre-Amplifier and Multi-Effects.

Makes overdrive effect by excessive gain of pre-amplifier. The sound made various changed by Multi-Effects.

◆ **To locate this mode:**



Or, holding either [OVERDRIVE], [EFFECT] button for a while.

See "Function mode" (P. 68) for operation details.

◆ **TUBE PRE-AMPLIFIER**

❶ **TUBE - ROUTING**

This is for selecting the route of the Tube Preamp signals.

Value	Pre Expression Tube	Post Expression Tube
X7toU7	12AX7	12AU7
U7toX7	12AU7	12AX7
U7toU7	12AU7	12AU7
X7toX7	12AX7	12AX7
BYPASS	None	None

❷ **TUBE - DRIVE**

This is for controlling the Drive amount of the Tube Preamp. The Non-linear distortion effects of the tone changes.

This parameter is enabled when the Tube routing ❶ is not on the "BYPASS".

See page 114 for details.

NOTE: The Tube Pre-Amplifier affects all organ types except "Pipe".

◆ **MATCHING TRANSFORMER**

❸ **TRANS - DRIVE**

Sets the saturation sensitivity of the matching transformer.

The setting range is 0 -127 , higher values saturate at softer signals.

❹ **TRANS - HYSTERESIS**

Sets the strength of the hysteresis characteristics.

The setting range is 0 - 127, higher values effect a more asymmetrical sound.

❺❻❼❽ **TRANS - DEPTH; UPPER, PERCUSSION, LOWER, PEDAL**

Sets the amount of the MT modeling for each Part.

The setting range is 0 - 127, higher values cause the effect to be deeper.

NOTE: The Matching Transformer affects all organ types except "Pipe".

tips TRANSFORMER MODELING

The sound is slightly distorted when the Tube - Routing or Overdrive at off. Because the MT (Matching Transformer) - Modelling is working at everytime.

The matching transformer is a electrical device for volume control of the Drawbars and transmits the audio signal to the pre-amplifier of the B-3/C-3.

The matching transformer has unique character (below figure), and reduces low and high frequencies. The tone quality will slightly narrow. But the character is recognized as a tone of the B-3/C-3.

Parameters

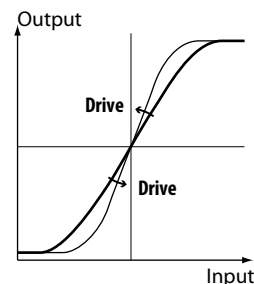

How the Trans - Drive works

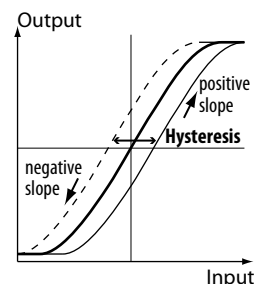

How the Trans - Hysteresis works

102 AMP / EFF (Pre-Amplifier / Multi-Effects) - continued

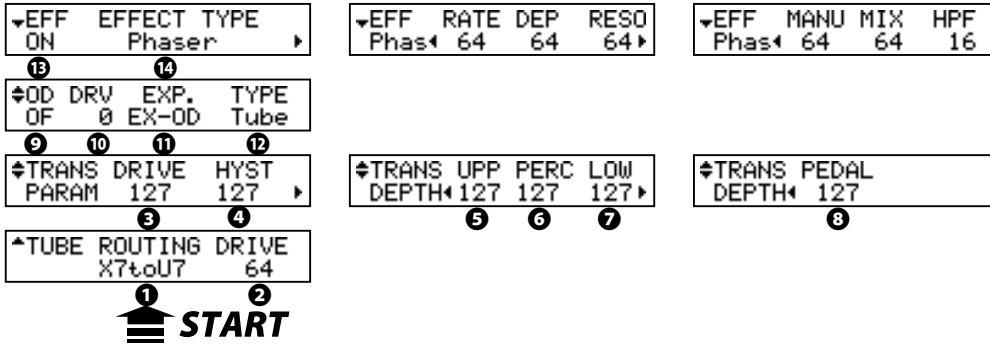

◆ OVERDRIVE

9 OVERDRIVE - SWITCH

Turns the Overdrive “On / Off”.

10 OVERDRIVE - DRIVE

Adjusts the drive component of the Overdrive. The higher you raise the value, more distortion is obtained. It is linked with the [OVERDRIVE DEPTH] knob on the top panel.

11 OVERDRIVE - EXPRESSION

Sets the response of Overdrive to Expression Pedal Value.

EX-OD: Overdrive effect increases/decreases along with volume.

OD-EX: Overdrive effect remains constant, only volume increases/decreases.

OD ONLY: Volume remains constant, Expression pedal increases/decreases overdrive effect.

INPUT: Expression pedal attenuates INPUT level to Overdrive effect. Lesser Volume control.

12 OVERDRIVE - TYPE

Sets the characteristic of the Overdrive.

Tube: Replicates a tube-driven amp.

Solid: Replicates a solid-state stomp box.

Clip: Accurate hard clip.

EPAmp: Replicates the pre-amplifier of an electric piano.

NOTE: The Overdrive affects all organ types except “Pipe”.

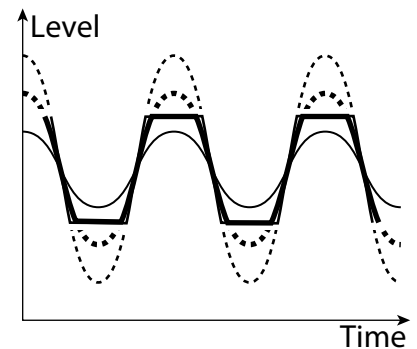

◆ **MULTI-EFFECTS**

13 **EFFECT - SWITCH**

Turns the Multi-Effects “On / Off”.

14 **EFFECT TYPE**

Selects the Multi-Effect type. The following effects are available.
Tremolo, Auto Pan, Wah-Wah, Ring Mod., Phaser, Flanger, Chorus, Delay
 The parameters for the Multi-Effects are vary by type (following).

◆ **Tremolo**

The tremolo modulates the amplitude cyclically. This effect is inserted in Pre-Overdrive.

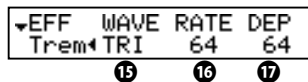
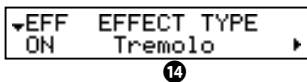

15 **TREMOLO - WAVEFORM**

Sets which waveform is used to modulate the volume.
Tri: Triangle wave. The volume changes smoothly.
Sqr: Square wave. The volume suddenly rises and falls.
Saw: Sawtooth wave. Repeated decaying sound is obtained.
S&H: Sample & hold. The volume changes randomly.
DSqr: Dull square wave like the old electric piano effect.

16 **TREMOLO - RATE**

Adjusts the speed of the tremolo cycle.
 The setting range is 0 to 127. The higher the value, the faster the cycle.
 It is linked with the [EFFECT AMOUNT] knob on the top panel.

17 **TREMOLO - DEPTH**

Adjusts the depth of the tremolo effect.
 The setting range is 0 to 127. At 0 the volume does not modulate. The higher the value, the deeper the effect. At 127 a repeated no sound/maximum volume is obtained.

◆ **Auto Pan**

Auto Pan applies adjustable modulation to the stereo field.
 This is not applicable if a monophonic (one channel) amp is used, or when the Leslie effect / Leslie speaker is used. This effect is inserted in Post-Overdrive.

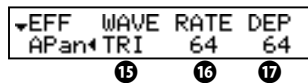
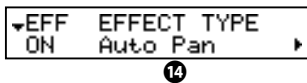

15 **AUTO PAN - WAVEFORM**

Sets which waveform to modulate the direction.
Tri: Triangle wave. The direction smoothly changes.
Sqr: Square wave. The direction suddenly moves to the left, and suddenly moves to the right.
Saw: Sawtooth waveform. The direction repeatedly moves from left to right.
S&H: Sample & hold. The direction changes randomly.
DSqr: Dull square wave like the old electric piano effect (recommended).

16 **AUTO PAN - RATE**

Adjusts the speed of the modulation.
 The setting range is 0 to 127. The higher the value, the faster the modulation. It is linked with the [EFFECT AMOUNT] knob on the top panel.

17 **AUTO PAN DEPTH**

Adjusts the depth of the cycle.
 The setting range is 0 to 127. At 0, there is no direction modulation. The higher the value, the deeper the effect becomes. At 127 you can give a perfect left/right repetition.

NOTE: When using “Pipe” Organ Type, some types of the Multi Effects are disabled; Tremolo, Wah-Wah, and Ring Modulator.

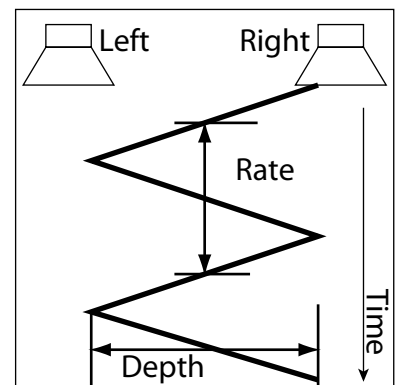
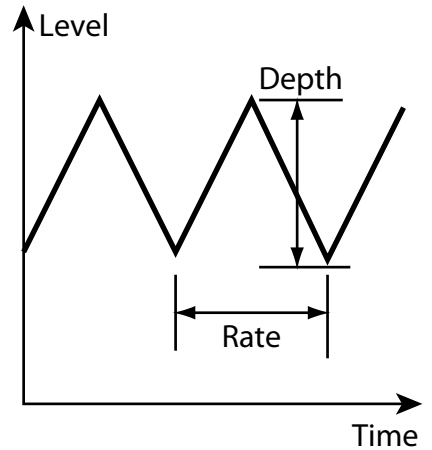

NOTE: All the parameters in these pages are Patch Parameters. They are recorded into the Patch.

104 AMP / EFF (Pre-Amplifier / Multi-Effects) - continued

◆ Wah-Wah

Wah-Wah imposes a “speech-like” dynamic to the sound. This effect is inserted in Pre-Overdrive.

▼EFF	EFFECT TYPE
ON	Wah-Wah

14

▼EFF	SRC	SENS	RES
Wah	◀LFO	64	64▶

15 16 17

▼EFF	WAVE	RATE	FREQ
Wah	◀Tri	64	64

18 19 20

15 Wah-Wah - SOURCE

Selects the source of the WAH control.

MAN: Uses the following FREQ parameter, i.e. the [EFFECT AMOUNT] knob.

EXP: Uses the Expression Pedal like a “Wah Wah pedal”.

LFO: Auto-Wah using the built-in ‘LFO - Low Frequency Oscillator’.

16 Wah-Wah - SENSITIVITY

Sets the sensitivity to change the Wah effect of LFO or Expression Pedal. It is linked with the [EFFECT AMOUNT] knob on the top panel when the SOURCE 15 is set at EXP or LFO.

The setting range is 0 to 127. The dynamic response increases as the value rises.

17 Wah-Wah RESONANCE

Boosts the cut-off frequency range of the Low-pass Filter and gives a more pronounced “Wah” effect. The setting range is 0 to 127. The resonance increases as the value rises.

18 Wah-Wah - WAVEFORM

When the SOURCE 15 is set at LFO, the LFO wave form is set.

Tri: Triangle wave. The sound smoothly varies.

Sqr: Square wave. The filter suddenly opens and suddenly closes.

Saw: Saw-tooth wave. Repeated changes in the sound are obtained.

S&H: Sample & Hold. Random sound changes are obtained.

19 Wah-Wah - RATE

When the SOURCE 15 is set at LFO, the cycle speed is adjusted.

The setting range is 0 to 127. The cycle becomes faster as the value increases.

20 Wah-Wah - FREQUENCY

Adjusts the central frequency. It is linked with the [EFFECT AMOUNT] knob on the top panel when the SOURCE 15 is set at MAN.

The setting range is 0 to 127. The frequency becomes higher as the value is increased.

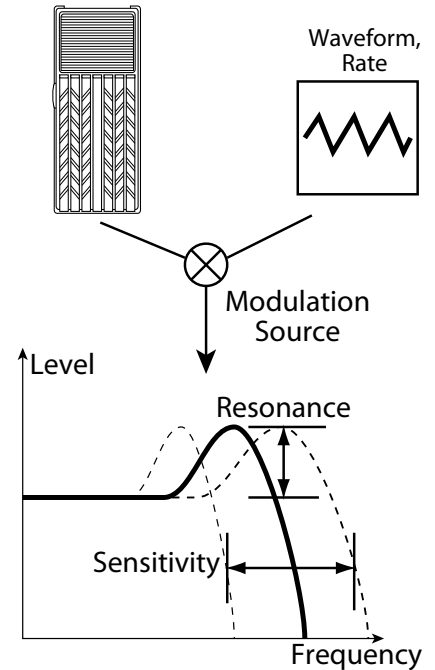

◆ Ring Mod.

The Ring Modulator creates complex, metallic-like sounds by taking the sum and difference of the fundamental tone and a second “ring” frequency. This effect is inserted in Pre-Overdrive.

▼EFF	EFFECT TYPE
ON	Ring Mod.

14

▼EFF	SRC	FREQ	MIX
RMod	MAN	64	64

15 16 17

▼EFF	WAVE	RATE	DEP
RMod	Tri	64	64

18 19 20

15 RING MODULATOR - SOURCE

Selects what to use to modulate the ring frequency.

MAN: Uses the following FREQ parameter, i.e. the [EFFECT AMOUNT] knob.

EXP: Modulates the ring frequency with the Expression Pedal.

LFO: Allows a cyclical modulation effect using the built-in LFO-Low Frequency Oscillator.

NOTE: The ring frequency changes by the note, i. d. the UPPER Part performance.

16 RING MODULATOR - FREQUENCY

Adjusts the central ring frequency. It is linked with the [EFFECT AMOUNT] knob on the top panel when the SOURCE 15 is set at MAN, EXP and NOTE.

The setting range is 0 to 127. The frequency becomes higher as the value increases.

17 RING MODULATOR - MIX

Adjusts the volume balance between the fundamental and effect sounds.

The setting range is 0 to 127. At 0, only the fundamental sound is heard. As the value is raised, the more effect is added. At 127, only the effect comes out.

18 RING MODULATOR - WAVEFORM

When the SOURCE 15 is set at LFO, the LFO waveform is set.

Tri: Triangle wave. The ring frequency number smoothly varies.

Sqr: Square wave. The ring sound suddenly changes to treble and also suddenly to bass.

Saw: Sawtooth wave. The ring sound repeatedly drops from treble to bass.

S&H: Sample & hold wave. The ring frequency changes randomly.

19 RING MODULATOR - RATE

When the SOURCE 15 is set at LFO, the frequency speed is adjusted. It is linked with the [EFFECT AMOUNT] knob on the top panel when the SOURCE 15 is set at LFO.

The setting range is 0 to 127. The cycle becomes faster as the value is raised.

20 RING MODULATOR - DEPTH

Adjusts the depth of the frequency change when the source is set at LFO or EXP.

The setting range is 0 to 127. The ring frequency becomes wider as the value is raised.

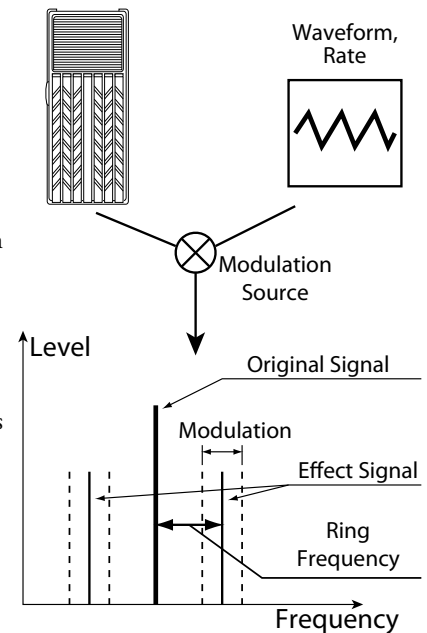

NOTE: All the parameters in these pages are Patch Parameters. They are recorded into the Patch.

106 AMP / EFF (Pre-Amplifier / Multi-Effects) - continued

◆ Phaser

This effect adds a twisting character to the sound by shifting phase. This effect is inserted in Post-Overdrive.

▼EFF	EFFECT TYPE
ON	Phaser ▶

14

▼EFF	RATE	DEP	RESO
Phas▶	64	64	64▶

15 16 17

▼EFF	MANU	MIX	HPF
Phas▶	64	64	16

18 19 20

15 PHASER - RATE

Adjusts the frequency speed. It is linked with the [EFFECT AMOUNT] knob on the top panel.

The setting range is 0 to 127. The cycle becomes faster as the value increases.

16 PHASER - DEPTH

Adjusts the depth of modulation.

The setting range is 0 to 127. The modulation becomes deeper as the value increases.

17 PHASER - RESONANCE

Adjusts the resonance (feed-back) amount.

The setting range is 0 to 127. The resonance becomes greater as the value increases. At higher values, the sound is modulated beyond normal recognition.

18 PHASER - MANUAL

Sets the middle frequency of the phase effect.

The setting range is 0 to 127. The frequency becomes higher as the value increases.

19 PHASER - MIX

Adjusts the volume balance between the “dry” and the effect sound.

The setting range is 0 to 127. At 0, only “dry” is heard. The effect level becomes greater as the value increases. At 127 the ratio between the “dry” and the effect sounds becomes 1:1.

20 PHASER - HPF

Controls the frequency range of the effect.

The setting range is 0 to 127. At 0 the effect is added to all frequencies. The effect is added to the higher frequencies as the value increases.

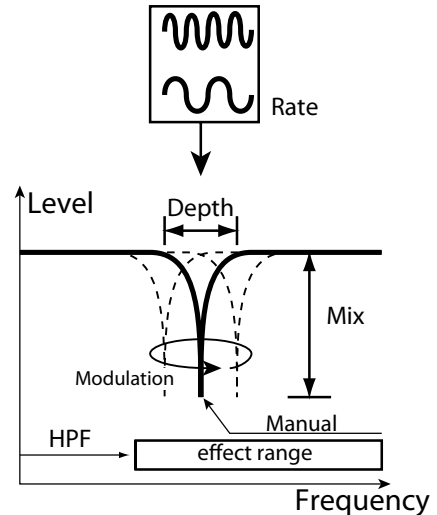

◆ Flanger

This effect has the sweeping “Jet Airplane” characteristic, adjustable from a mild shimmer to a deep “swoosh”. This effect is inserted in Post-Overdrive.

▼EFF	EFFECT TYPE
ON	Flanger ▶

14

▼EFF	RATE	DEP	RESO
Flng▶	64	64	0▶

15

16

17

▼EFF	DLAY	MIX	HPF
Flng▶	0	64	64

18

19

20

15 FLANGER - RATE

Adjusts the modulation speed. It is linked with the [EFFECT AMOUNT] knob on the top panel.

The setting range is 0 to 127. The cycle becomes faster as the value increases.

16 FLANGER - DEPTH

Adjusts the depth of modulation.

The setting range is 0 to 127. The modulation becomes deeper as the value increases.

17 FLANGER - RESONANCE

Adjusts the amount of resonance (feed-back).

The setting range is 0 to 127. The resonance becomes greater as the value increases. At higher values, the sound is modulated beyond normal recognition.

18 FLANGER - DELAY

Controls the delay of the effect sound.

The setting range is 0 to 127. The delay increases as the value is increased.

19 FLANGER - MIX

Adjusts the volume balance between the “dry” and the effect sound.

The setting range is 0 to 127. At 0, only the “dry” is heard. The effect level becomes greater as the value is increased. At 127 the ratio between the “dry” and the effect sounds becomes 1:1.

20 FLANGER - HPF

Controls the frequency range of the effect.

The setting range is 0 to 127. At 0 the effect is added to all frequencies. The effect is added to the higher frequencies as the value increases.

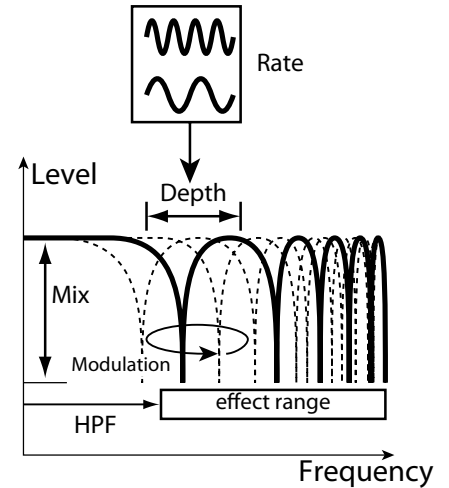

NOTE: All the parameters in these pages are Patch Parameters. They are recorded into the Patch.

108 AMP / EFF (Pre-Amplifier / Multi-Effects) - continued

◆ Chorus

This “Chorus” is NOT the same as Hammond’s proprietary “Chorus-Vibrato”. This effect is the familiar Chorus as heard widely on electric pianos, guitars, etc. This effect is inserted in Post-Overdrive.

▼EFF	EFFECT TYPE
ON	Chorus ▶

14

▼EFF	RATE	DEP	RESO
Cho ◀	64	64	0 ▶

15 16 17

▼EFF	DLY	MIX	HPF	PH
Cho ◀	0	64	64	3

18 19 20 21

15 CHORUS - RATE

Adjusts the speed of the cycle of the rising and falling effect pitch. It is linked with the [EFFECT AMOUNT] knob on the top panel.

The setting rate is 0 to 127. The cycle becomes faster as the value increases.

16 CHORUS - DEPTH

Adjusts the depth of modulation.

The setting range is 0 to 127. The modulation becomes deeper as the value increases.

17 CHORUS - RESONANCE

Adjusts the amount of resonance (feed-back).

The setting range is 0 to 127. The resonance becomes greater as the value increases. At higher values, the sound is modulated beyond normal recognition.

18 CHORUS - DELAY

Controls the delay of the effect sound.

The setting range is 0 to 127. The delay becomes greater as the value increases.

19 CHORUS - MIX

Adjusts the volume balance between the “dry” and the effect sound.

The setting range is 0 to 127. At 0, only the “dry” is heard. The effect level becomes greater as the value increases. At 127 the ratio between the “dry” and the effect sounds becomes 1:1.

20 CHORUS - HPF

Controls the frequency range of the effect.

The setting range is 0 to 127. At 0, the effect is added to all frequencies. The effect is added to the higher frequencies as the value increases.

21 CHORUS - PHASE

Selects the type of the chorus effect available:

“2” (normal) or “3” (rich) phase effect type.

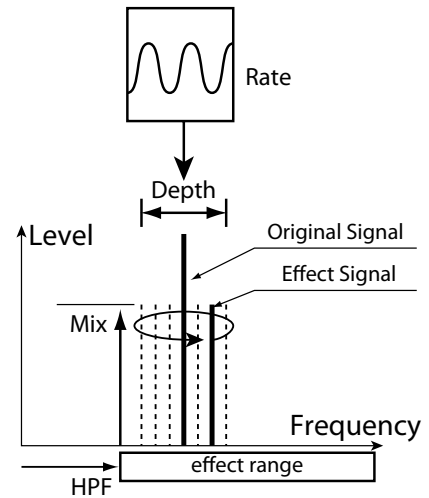

◆ **Delay**

This is for adding echo effects. This effect is inserted in Post-Overdrive.

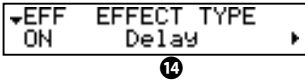

14

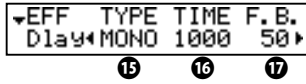

15

16

17

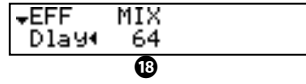

18

15 **DELAY - TYPE**

Select the type of delay here.

MONO:

A simple monophonic "echo".

RtoL, LtoR:

The delay is alternated in the stereo field. At RtoL the delayed sound comes from the right, and at LtoR from the left. Your results may vary when used in a mono hookup, or through a Leslie Speaker.

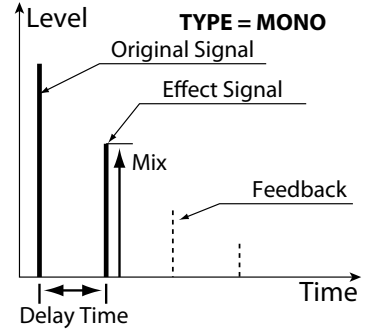

16 **DELAY - TIME**

Adjusts the delay time. It is linked with the [EFFECT AMOUNT] knob on the top panel.

The setting range is 10 to 1000 ms.

17 **DELAY - FEED-BACK**

Sets the repetition amount of the effect sound.

The setting range is 0 to 127. The repetition becomes greater as the value is increased.

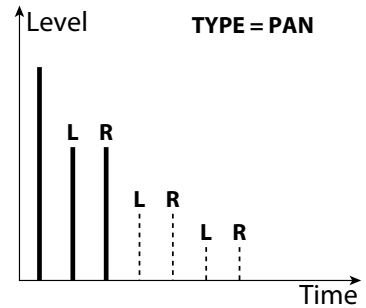

18 **DELAY - MIX**

Adjusts the volume balance between the "dry" and the effect sound.

The setting range is 0 to 127. At 0, only the "dry" is heard. The effect level becomes greater as the value is increased. At 64 the ratio between the "dry" and the effect sounds becomes 1:1. At 127 only the effect sound is heard.

NOTE: All the parameters in these pages are Patch Parameters. They are recorded into the Patch.

EQUALIZ (Equalizer)

In this mode, you adjust the settings for the Equalizer.

An Equalizer is used to adjust the tonal quality. The XK-5's built-in Equalizer consists of 3 bands and a recreation of the unique "tone" control that was part of the B-3/C-3. The Bass and Treble bands are handled by "shelf" equalizers, and the Mid band is handled by parametric control.

◆ **To locate this mode:**



See "Function mode" (P. 68) for operation details.

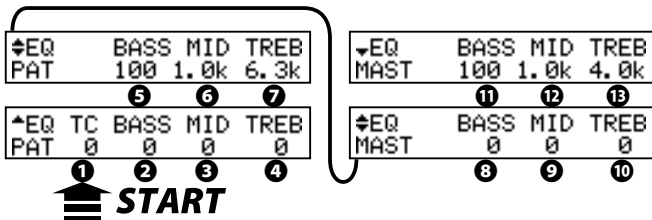

◆ **PATCH EQUALIZER**

❶ **TONE CONTROL (P)**

This parameter duplicates the performance of the tone control on the AO-28 preamp found in the B-3/C-3. Its response is unique, to cut the overall treble above 200 Hz gently.

The setting range is -9 to +9, and it becomes neutral when set at "0". "-1" corresponds to the maximum of the B-3/C-3 tone control, "-5", the middle, "-9", the minimum. The tone control found on the B-3/C-3, was only available at "minus" settings, but here you are able to "plus" the settings as well.

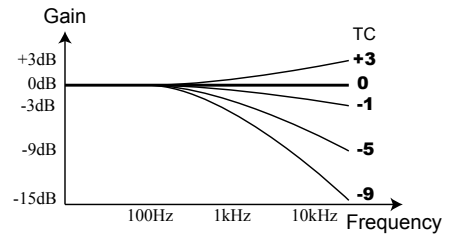

Diagram of Tone Control

◆ **PATCH EQUALIZER AND MASTER EQUALIZER**

❷, ❸ **GAIN - BASS (P), (G)**

❸, ❹ **GAIN - MIDDLE (P), (G)**

❹, ❷ **GAIN - TREBLE (P), (G)**

Adjusts the Boost/Cut of Bass, Mid-range and Treble respectively.

The setting range is -9 to +9. It is flat at 0.

❺, ❶ **FREQUENCY - BASS (P), (G)**

❻, ❷ **FREQUENCY - MIDDLE (P), (G)**

❼, ❸ **FREQUENCY - TREBLE (P), (G)**

Adjusts the center frequency (MIDDLE) / turnover frequency (BASS, TREBLE) to be attenuated.

The setting range is 20Hz - 308Hz for BASS, 250Hz - 3.1kHz for MIDDLE, 3.0kHz - 8.0kHz for TREBLE.

NOTE: The sound may distort if gains are raised too high. Adjust accordingly.

NOTE: The parameter with (P) indicated is a patch parameter, and is recorded to each patch. (G) indicates "global parameter", which is recorded upon being set, and is common with each patch.

NOTE: When using "Pipe" Organ Type, the Patch Equalizer is disabled.

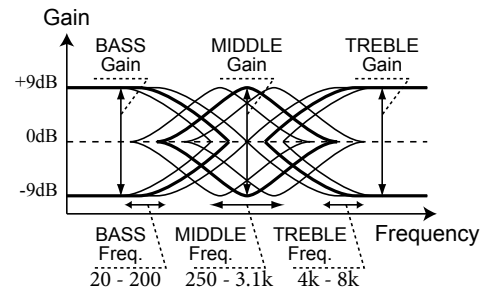

Diagram of 3-bands Equalizer

tips **TURNOVER FREQUENCY**

The MIDDLE of this equalizer controls a point of frequency. This is called center frequency. The BASS (or TREBLE) controls lower (or higher) than specified frequency. This is called turnover frequency.

tips **PATCH PARAMETERS**

The equalizer is designed to be a patch parameter to be actively utilized as a part of sound making parameter. Use the Master Equalizer (P. 33) for tonal compensation to match the performance stage.

In this function mode, adjusts the reverb effect.

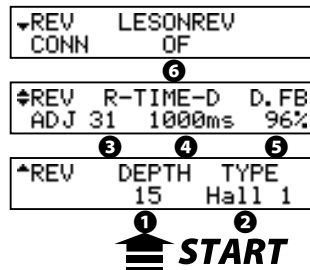
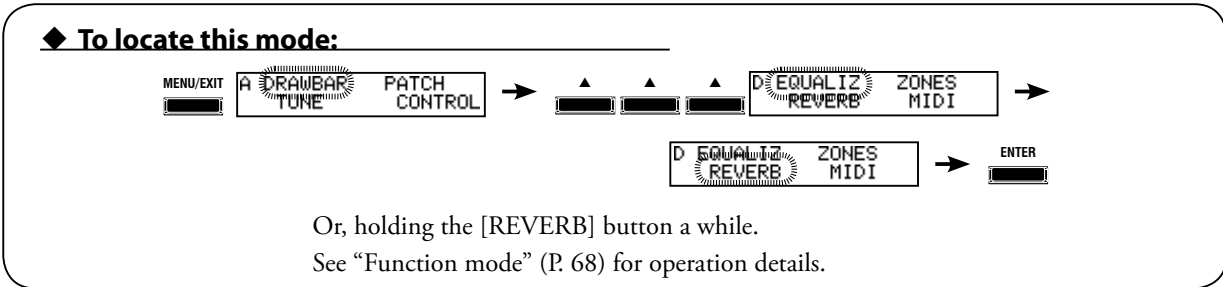

1 DEPTH

This sets the depth (volume) of the Reverb Effect.
The setting range is 0 to 127.

2 TYPE

This sets the types of Reverb effect.

- Room 1:** Small room
- Room 2:** Large room
- Live:** Ambient room
- Hall 1:** Large Hall
- Hall 2:** Small Hall
- Church:** Church
- Plate:** Iron-plate Reverb
- Spring:** Spring Reverb
- Delay:** Delay
- PanDly:** Panning Delay
- RevDly:** Reverb + Delay

3 REVERB TIME

When the Type (#2) is set at Room 1 to Spring, The decay of the Reverb is attenuated.
The setting range is 0 to 127. The decay becomes greater as the value is increased.

4 DELAY TIME

When the Type (#2) is set at Delay, PanDly, RevDly, this parameter sets the delay time.
The setting range is 4.7 to 2000ms. The delay becomes longer as the number value is increased.

NOTE: You can set the delay time with the foot switch. (P. 78 #1)

5 DELAY FEEDBACK

When the Type (#2) is at Delay, PanDly, RevDly, it sets the amount of Feedback (How many times the sound repeats.)
The setting range is 0 to 96%. The repetition becomes greater as the value is increased.

NOTE: Type (#2) is a macro-parameter. When you change the type, each reverb parameter (#3 to #5) is automatically set to the recommend value.

6 LESLIE ON REVERB

This sets the routing of the Reverb effect.
OFF: Leslie to Reverb
ON: Reverb to Leslie

tips LESLIE ON REVERB

In the past when there are no electronic Leslie effect, the sound sent to the Leslie speaker with reverb effect. It made a sound which rotated reverb too.
The Leslie On Reverb simulates that.

NOTE: All the parameters in these pages are Patch Parameters. They are recorded into the Patch.

DEFAULT

In this mode, you can go back totally or partially to the factory default settings.

◆ To locate this mode:

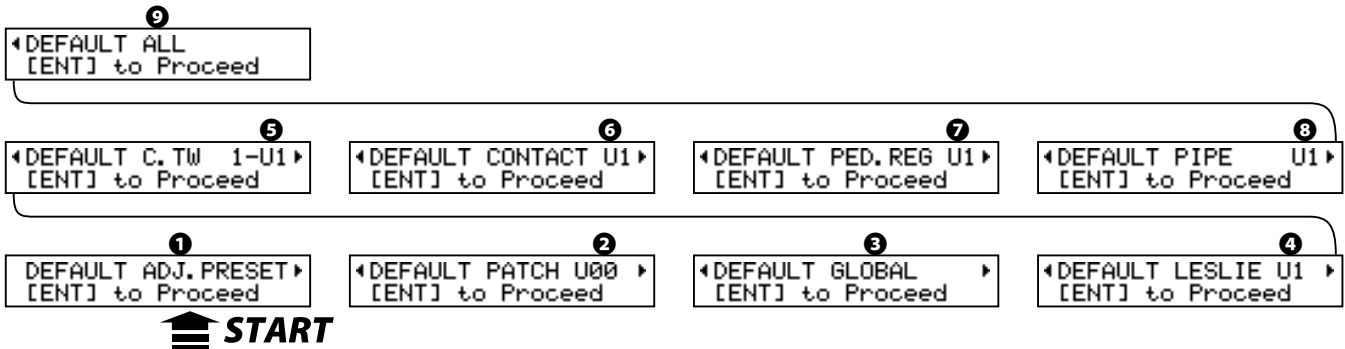

To initialize each parameter, select the parameter you want to initialize with the [◀][▶] button and press the [ENTER] button.

1 ADJUST PRESET

Initializes the contents of the Preset Key [A#] and [B].
Used to create a “clean slate” for new Patch settings.

2 PATCH

This is for initializing the User Patch contents (from Factory Patch with same Patch number). Select the Patch you want to initialize with the [VALUE] knob. The selecting range is U00 to U99 and ALL (All User Patches).

3 GLOBAL

This is for initializing the Global Parameters such as the Master Tune or assignment of the Foot Switch.

4 CUSTOM LESLIE CABINETS

This is for initializing the contents of all internal Leslie Cabinets. Select the number you want to initialize with the [VALUE] knob. The selecting range is U1 to U8 and ALL (All User Cabinets).

5 CUSTOM TONE WHEELS

This is for initializing the contents of all Custom Tone Wheels. Select the number you want to initialize with the [VALUE] knob. The selecting range is shown as below and ALL (All Custom Tone Wheels).

A-U1: A-100, U1

A-U2: A-100, U2

A-U3: A-100, U3

B-U1: B-3, U1 (similarly)

C-U2: C-3, U1 (similarly)

M-U1: Mellow, U1 (similarly)

6 CUSTOM CONTACTS

This is for initializing the contents of all Custom Contacts. Select the number you want to initialize with the [VALUE] knob. The selecting range is U1 to U3 and ALL (All User Contacts).

7 PEDAL REGISTRATION

This is for initializing the contents of all Pedal Sub Drawbars. Select the number you want to initialize with the [VALUE] knob. The selecting range is U1 to U3 and ALL (All User Pedal Sub Drawbars).

8 CUSTOM PIPES

This is for initializing the contents of all Custom Pipe Stops. Select the number you want to initialize with the [VALUE] knob. The selecting range is U1 to U3 and ALL (All User Pipe Stops).

9 ALL

This is for initializing all parameters of this keyboard.

If any unstable condition occurs on this keyboard system, initializing “all” will usually clear the problem.

NOTE: You can also totally initialize this keyboard by switching the power ON while pressing and holding the [RECORD] button.

In this function mode, sets and shows the system parameters.

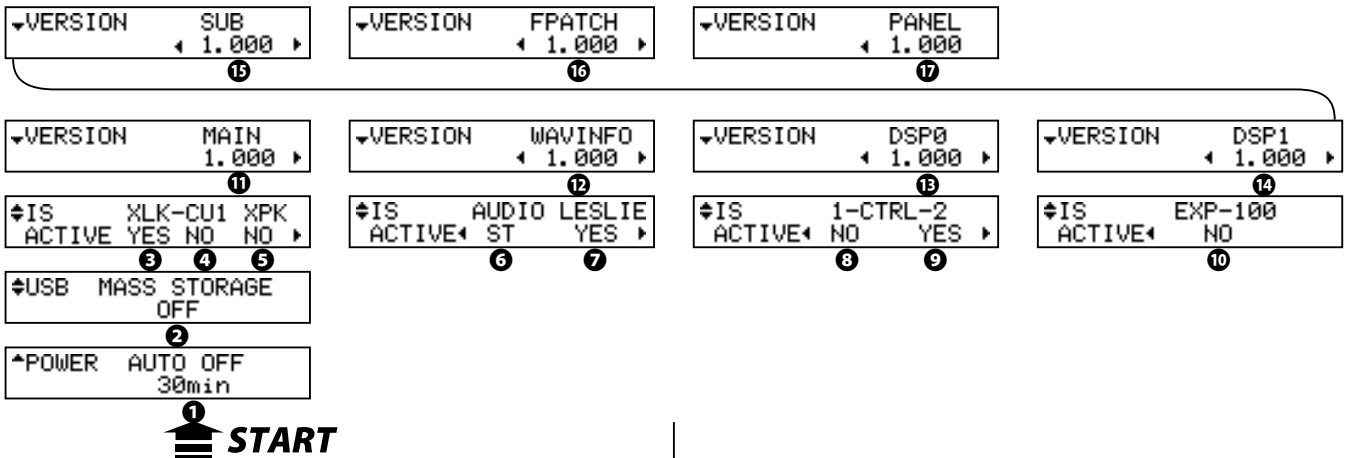
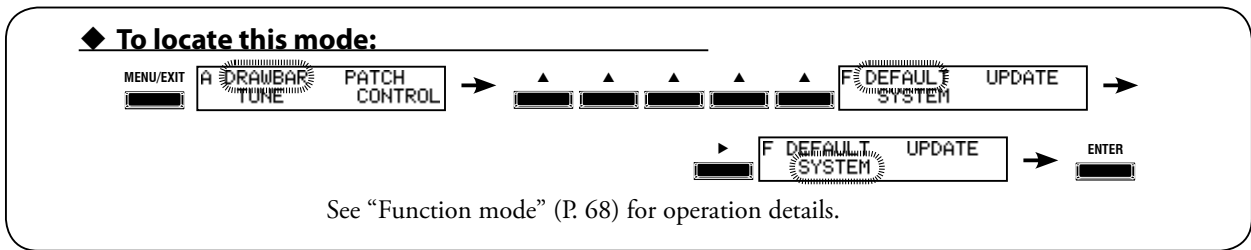

◆ POWER

① POWER - AUTO OFF

Sets whether power off after a certain time is elapsed since last operated.

30min: Powers off if the time is elapsed 30 minutes since last played/operated.

DISABLE: Disable auto off.

◆ USB

② MASS STORAGE

Sets function of the USB TO HOST jack.

OFF: To send/Receive the MIDI and audio stream.

ON: To access the internal memory.

◆ PERIPHERAL DEVICE

③ IS ACTIVE - XLK

Shows whether is Lower keyboard (e.g. XLK-5) active over -BUS jack.

④ IS ACTIVE - CU1

Shows whether is CU-1 active via -BUS (e.g. XLK-5).

⑤ IS ACTIVE - XPK

Shows whether is Pedalboard (e.g. XPK-250W) active over -BUS jack.

⑥ IS ACTIVE - AUDIO

Shows the status of the LINE OUT jacks.

ST: The LINE OUT hooked up both L and R jacks, or not used. The audio outputs in stereo.

MONO: The LINE OUT hooked up only L/MONO jack. The audio outputs in mono.

⑦ IS ACTIVE - LESLIE

Shows whether is Leslie speaker system active over LESLIE 11 pin jack.

The audio outputs LINE OUT jacks when the Leslie speaker system is active, Leslie channel is at single, besides [BYPASS] button is "On".

⑧ IS ACTIVE - FOOT CONTROLLER 1

⑨ IS ACTIVE - FOOT CONTROLLER 2

Shows whether is FOOT CONTROLLER 1/2 jack in use.

⑩ IS ACTIVE - EXP-100

Shows whether is EXP. PEDAL jack in use.

NOTE: This detects the current for lamp in the Expression Pedal. It does not detect the other devices using this jack (e.g. XLK-3).

◆ SOFTWARE VERSION

⑪ VERSION - MAIN PROGRAM

⑫ VERSION - WAVE & INFORMATION

⑬ VERSION - D. S. P. 0 PROGRAM

⑭ VERSION - D. S. P. 1 PROGRAM

⑮ VERSION - SUB PROGRAM

⑯ VERSION - FACTORY PATCH

⑰ VERSION - CONTROL PANEL

These are display only and not intended for System update use.

Column: Tube without distortion?

The tube circuits of 12AX7 and 12AU7 on this unit do not actively distort. The so-called Clipping Distortion is made with the Overdrive Effects.

◆ What is Non-linear Distortion?

If so, what job of the tube circuit in this keyboard? It is change of the linearity. Please see below picture.

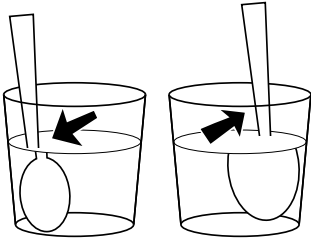

Put a spoon into a glass of water and try to move the spoon. The spoon looks as if it distorts its shape with every change of its position.

It is because the thickness of water is not constant from your eyes.

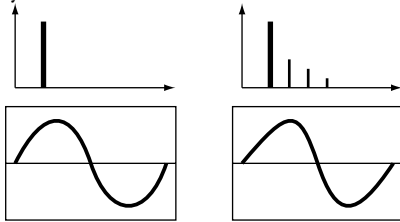

The sound of a little broken wave-form of the original sound gives the sounds with harmonics added.

The frequencies of the harmonics obtained here are the integral multiple of the original sound. They are called “integral multiple harmonics”.

◆ Sound Characteristics

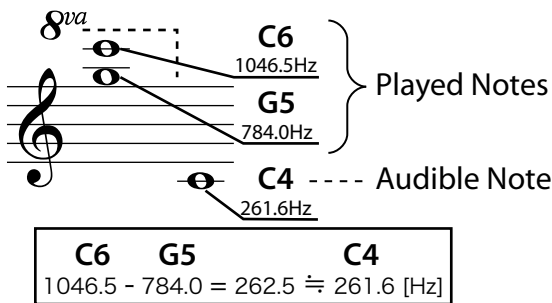

The emphasizing of the “difference note” is characteristics of the non-linear distortion. For example, pull out the 8’ Drawbar, play “G” and above “C”, you will hear another “C” which 2 octave lower. This is the difference note.

◆ Difference Characteristics by Tubes

The tubes 12AX7 and 12AU7 on this unit have tone characters different from each other. The next figure is the sonogram measured how the harmonics are added to the output signals, by inputting the 100Hz sine wave to “fade in” to each tube

circuit.

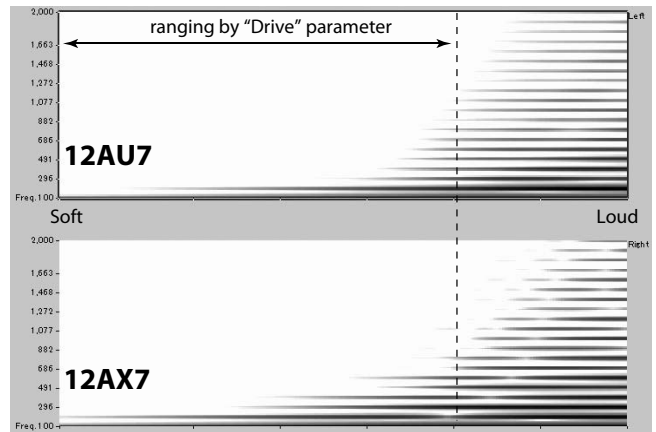

If you compare 12AX7 with 12AU7, while the integral multiple harmonics of 12AU7 regularly increase as the volume increases, you can see the integral multiple harmonics of 12AX7 increase “with spots”.

◆ Pre or post of the Expression

In the tube circuit before the Expression it gives a constant distortion, and after the Expression it gives a distortion according to the volume change.

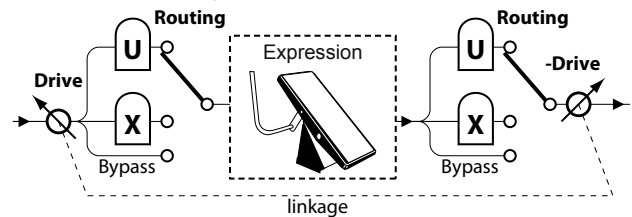

Each of 12AX7 and 12AU7 tubes has 2 elements. By utilizing them, this unit has a function of switching which element of 12AX7 or 12AU7 to pass before and after the Expression.

◆ Influences to the Performance

The tone synthesis with drawbars may be often considered simple. However, you can play with colorful tone variations using the chromatic incidental sound with the leakage tone, or with the integral multiple harmonics or the differential sound through tube circuits.

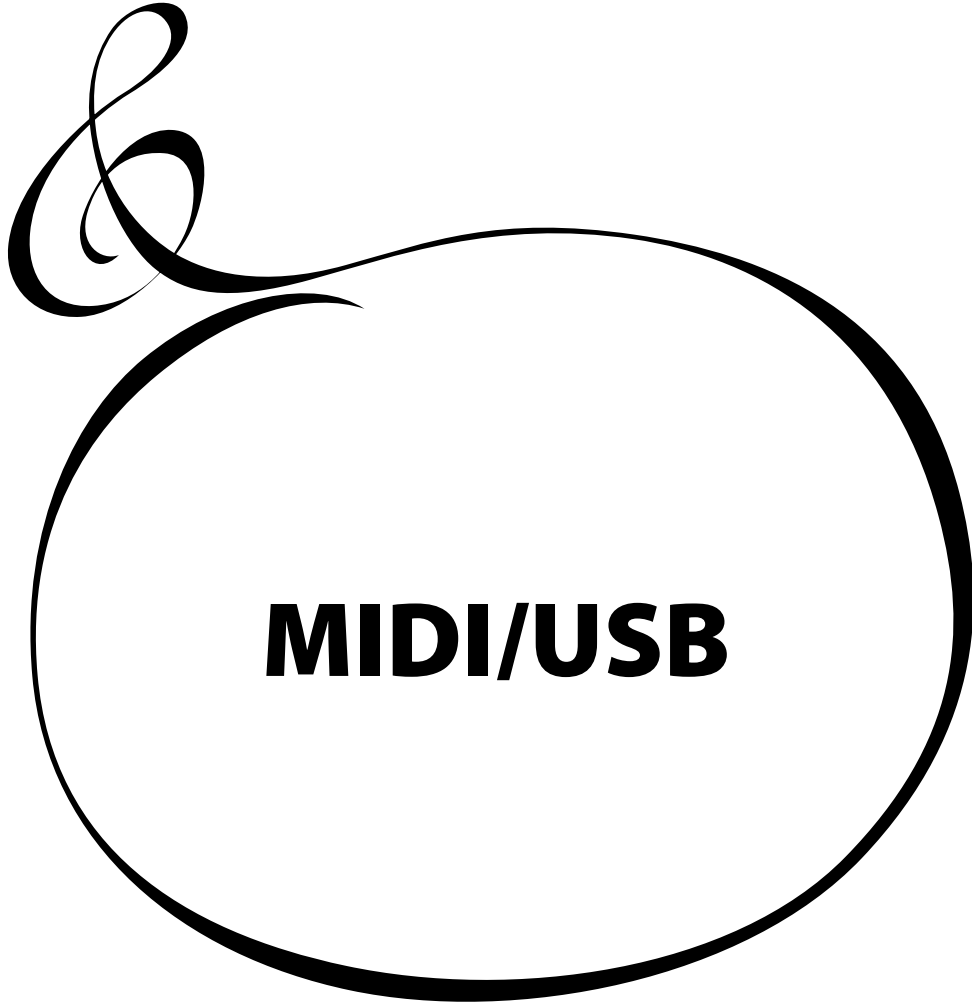

WHAT IS “MIDI”?

MIDI is an acronym of ‘Musical Instrument Digital Interface’.

MIDI is the musical instrument industry standard for exchanging performance information between electronic musical instruments and a sequencer, effects, lighting, and sound reinforcement gear, etc.

The MIDI standard allows instruments made by different manufacturers to effectively communicate with each other.

Many types of data can be transmitted and received, including all performance information, settings of parameters, and global commands.

WHAT IS “USB”?

USB is an acronym of “Universal System Bus”. It is industry standard for connecting a computer and peripheral devices. This keyboard has two USB jacks. A type A jack for connecting USB Flash Drive, and a type B jack for connecting the computer.

MIDI/USB JACKS ON THIS KEYBOARD

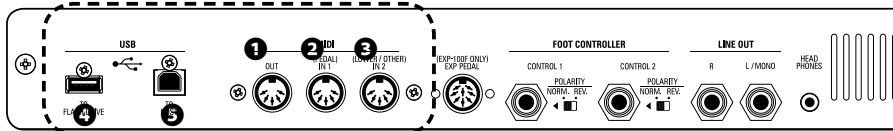

❶ MIDI OUT JACK

This jack sends performance information to an external MIDI sound module, or to record performances and controls to an external sequencer.

❷ MIDI IN 1 / PEDAL JACK

❸ MIDI IN 2 / OTHER JACK

This jack is used for playing this keyboard from external MIDI equipment.

❹ USB FLASH DRIVE JACK

For attaching the USB Flash Drive.

❺ USB TO HOST JACK

Connecting a computer.

WHAT MIDI CAN DO ON THIS KEYBOARD

On this keyboard, the MIDI jacks are intended to do the following:

- ♦ Use a MIDI keyboard/pedalboard to expand the playing versatility.
- ♦ Control an external sound generator such as a synthesizer or sampler.
- ♦ Record/playback performances on an external sequencer or computer.

For easier access to those settings, this keyboard is equipped with “MIDI Templates”.

WHAT THE USB TO HOST CAN DO ON THIS KEYBOARD

On this keyboard, the USB TO HOST jack is intended to do the following:

- ♦ Send / receive the MIDI data (Keyboard channel Upper, Lower, Pedal and system exclusive messages).*1
- ♦ Sending audio stream (same as LINE OUT jack).*1
- ♦ Sending / receiving Setup files and System files.

*1: Complies USB audio class 1.0.

tips USB AUDIO CLASS

When this keyboard hooks up to the computer via USB cable, it can send/receive the MIDI and send the audio stream without exclusive device driver. Because this keyboard is complied with USB audio class 1.0.

USB audio class 1.0 is the generic device driver which pre-installed on the Windows or Mac OS.

◆ MIDI CHANNEL

MIDI has 16 “Channels”. All channels are transmitted through a single MIDI cable. MIDI send/receive channels must match for proper communication between devices.

MAIN MIDI MESSAGE

MIDI information is grouped into a channel message per each of the 16 channels and a system message for all channels. There are more details in the MIDI IMPLEMENTATION CHART.

◆ CHANNEL MESSAGE

◆ NOTE ON

This data tells: which key (Note Number) is played, at what speed (Velocity) and the strike/release (Note On/Off).

◆ PROGRAM CHANGE

Control Channel:

Switches the internal patches of this keyboard.

External Zone Channel:

Switches the external MIDI equipment's patches.

◆ CONTROL CHANGE

The messages are transmitted (sent or received) in accordance with the motion of select controls on the top panel, any foot or auxiliary pedals, or any MIDI controller information.

◆ SYSTEM MESSAGE

◆ SYSTEM EXCLUSIVE MESSAGE

This message is for transmitting particular data between compatible equipment of the same model or same make.

This keyboard can do a memory dump (= sending the total information complement onboard) recording it to an external sequencer.

MIDI STRUCTURE

This keyboard has “Keyboard Channels” to transmit playing information of the keyboards and “External Zone Channels” to control external MIDI equipment on the keyboards.

Map of the MIDI structure on XK-5 Non-Keyboard Extended

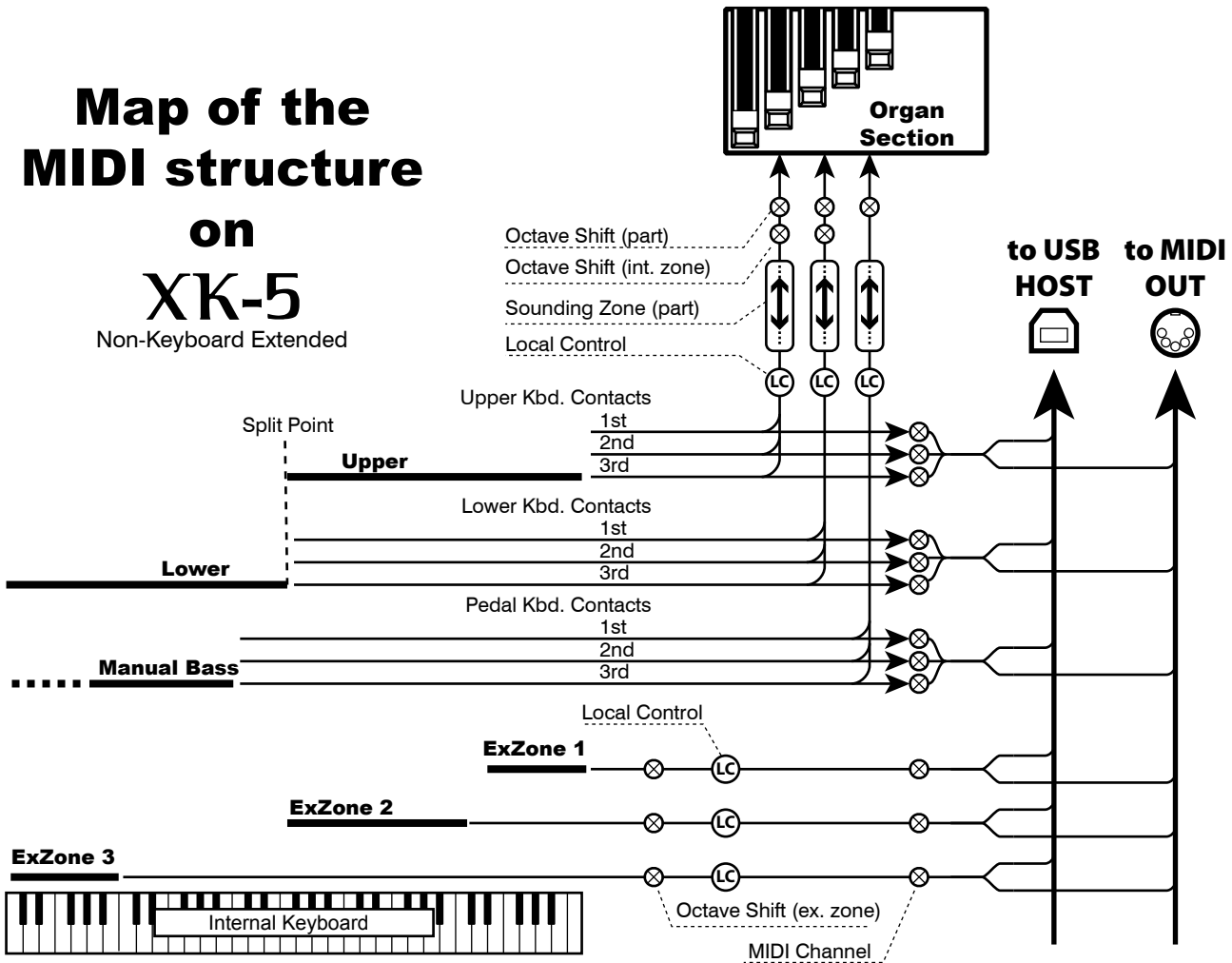

◆ KEYBOARD CHANNELS

The Keyboard channels transmit playing information of the Upper, Lower and Pedal parts. These are used to exchange playing information with an external sequencer.

The Upper channel transmits keyboard and controller data.

◆ EXTERNAL ZONE CHANNELS

The External Zone channels are for using this keyboard as a simple master keyboard to control external MIDI equipment. These are Patch parameters, and it is possible to make different settings to each Patch.

There are 6 external zones in total. 3 zones for the Upper, 2 for Lower, and 1 for Pedal.

◆ EXPANDED KEYBOARDS

When a MIDI keyboard is used to expand the Lower and Pedal parts, they behave as if the built-in keyboard on the keyboard, and, not only sounds the built-in sound generator, but also are transmitted through the MIDI OUT jack to the keyboard channels as well as transmitted to the external zones.

Map of the MIDI structure on XK-5 Keyboard Extended

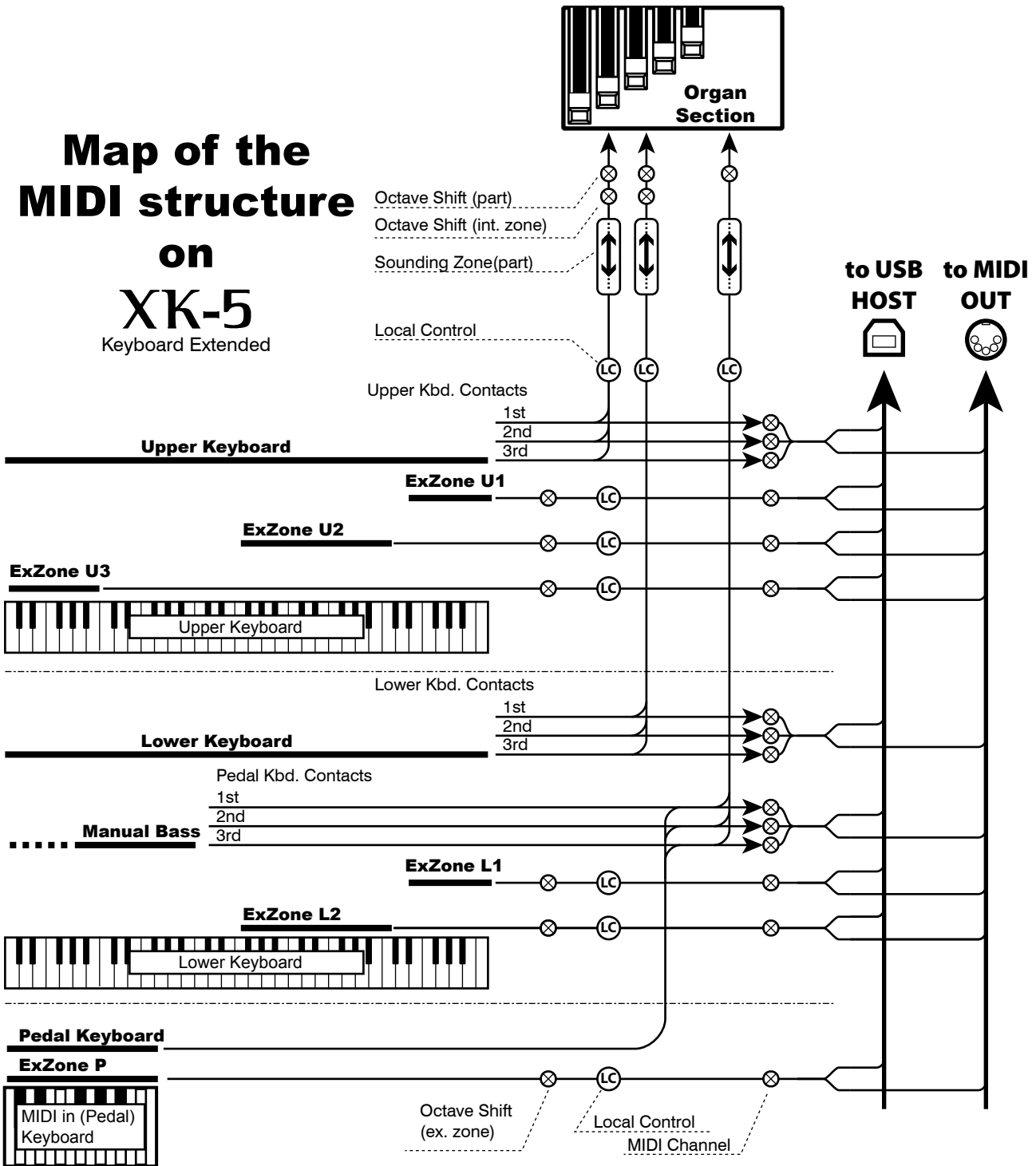

USING AN EXTERNAL SEQUENCER

This is to record/playback the performance by connecting an external sequencer or computer with DAW to this keyboard.

◆ Recording a organ performance to an Sequencer/DAW

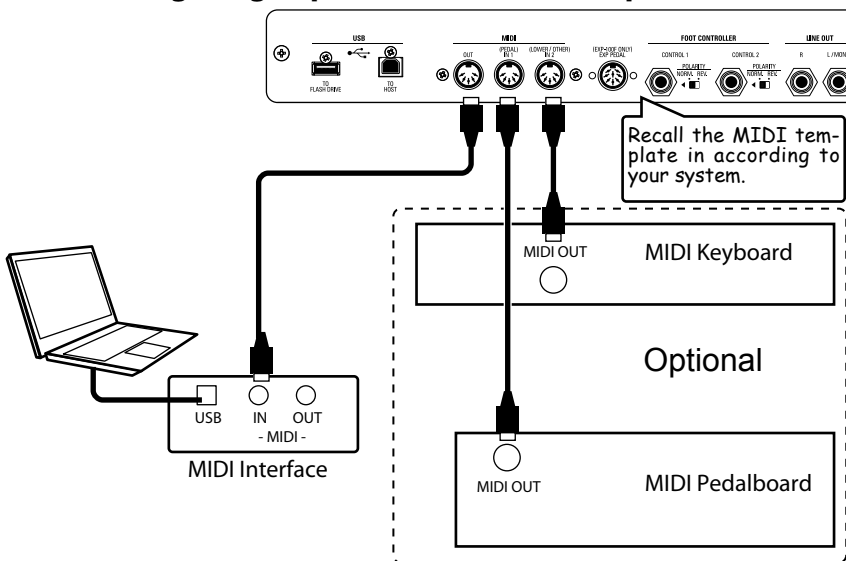

It requires re-hook up by record/playback if the MIDI cables used Pedal and Lower keyboards and a sequencer. Because the number of MIDI jacks more than equipped on this keyboard.

1. Hook up as left figure.
2. Recall the MIDI template except of "Use Ex." - Which according to your environment "Basic", "Two Manual", "Pedal keyboard", or "3KBD" (P. 128).

It cannot recording the performance what including the controlling the External Zones.

3. Set the MIDI channels of the sequencer / DAW.

Record the channel 1 when you play only the Upper. To record all the parts, record the channel 1 to 3 for Upper Lower and Pedal (in default).

4. Start recording of the sequencer/DAW.
5. Send the memory dump if necessary.
6. Start your performance.

◆ Sequencer playback

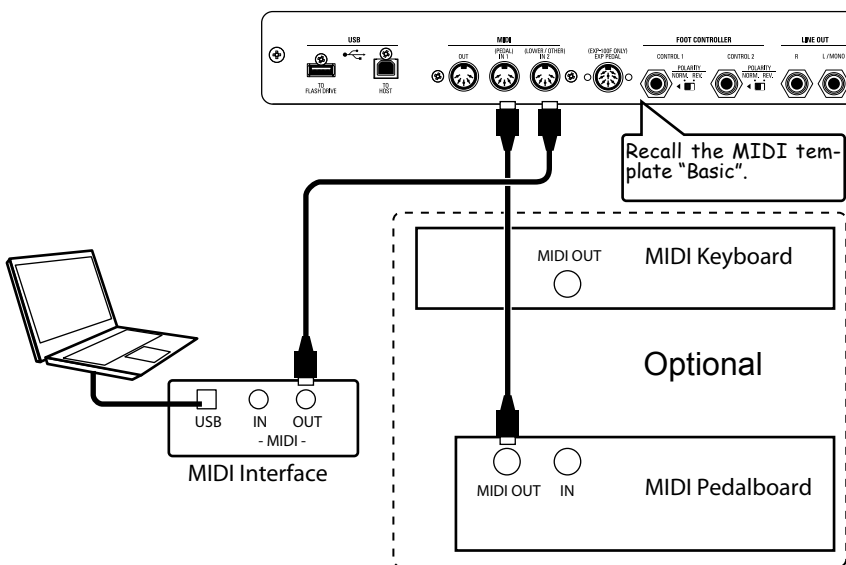

1. Hook up as left figure.
2. Recall the MIDI template at "Basic" (P. 128).
3. Start playback of the sequencer/DAW.

◆ Recording a performance to an computer DAW over USB

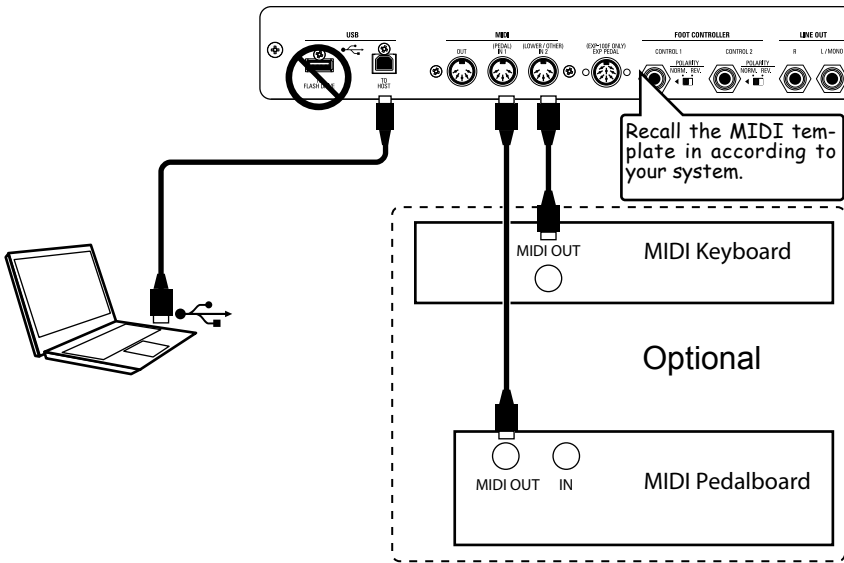

Using the “To Host” USB jack, it becomes easier to use a DAW for Recording/Playback, and reduces/eliminates the number of connections/cables required.

NOTE: To avoid the noise, remove the USB Flash memory during using USB audio.

◆ Recording a performance with using XLK-5, XPK-250W

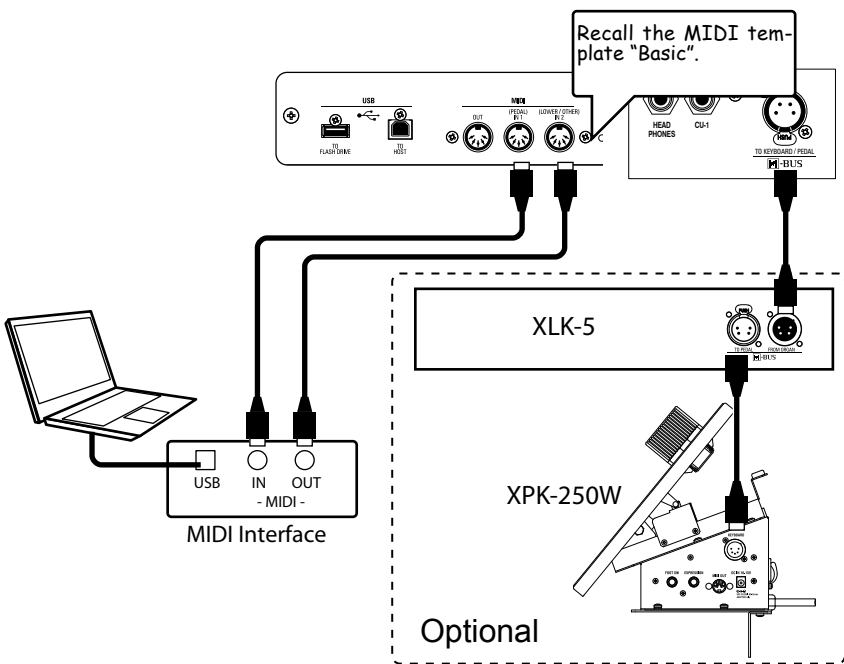

When using the XLK-5 and XPK-250W, It is not necessary to re-connect MIDI cables, as all inter-instrument communication is handles by the -BUS.

USING A MIDI SYNTHESIZER

You can control an external MIDI sound module with the built-in keyboard and the expanded MIDI keyboard.

BASIC HOOK UP

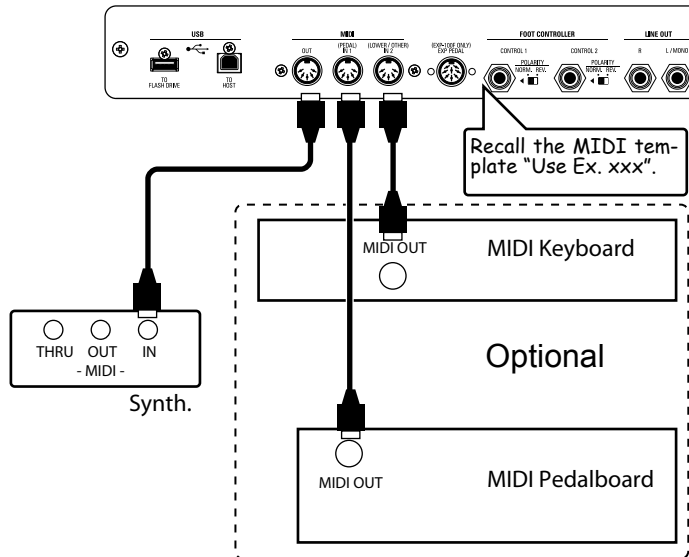

1. Hook up as left figure.

Hook up the MIDI OUT of this keyboard to MIDI IN of the MIDI synthesizer.

2. Recall the MIDI template "Use Ex. xxx" (P. 128).

This makes stop the communications of the keyboard channels, and send the External Zone performance using MIDI OUT.

Choose the each MIDI template by whether is keyboard extended.

The connected MIDI keyboards works as "local", out of the keyboard channels.

3. Set the parameters of each zone, record to the patch if necessary.

Please see "ZONES" at next paragraph to setting zones.

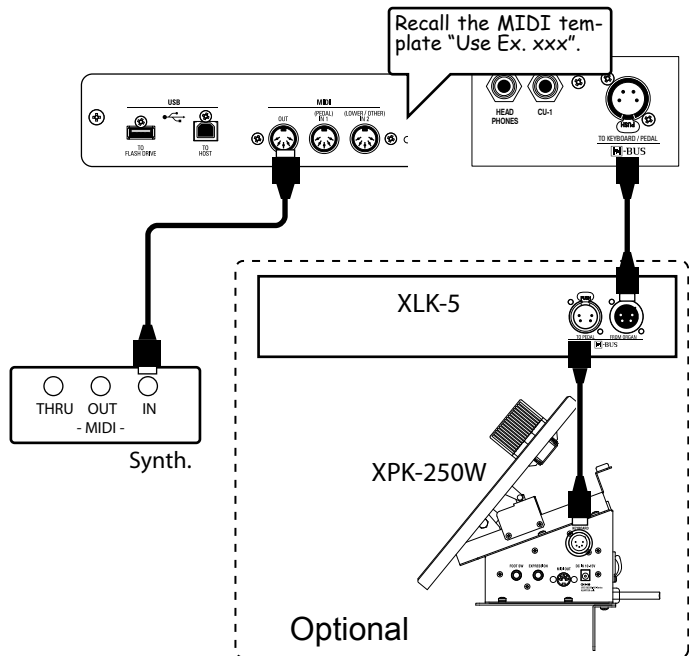

As above, Using the XLK-5 and XPK-250W will negate the use of extra MIDI cables for their use.

tips NOTE ON THE SOUNDING POINT

The External Zone sounds at a little deeper point of the key than the Drawbar tone. This is for outputting the velocity information to the External Zone.

RECORD AND PLAYBACK

◆ Recording a performance to a sequencer/DAW

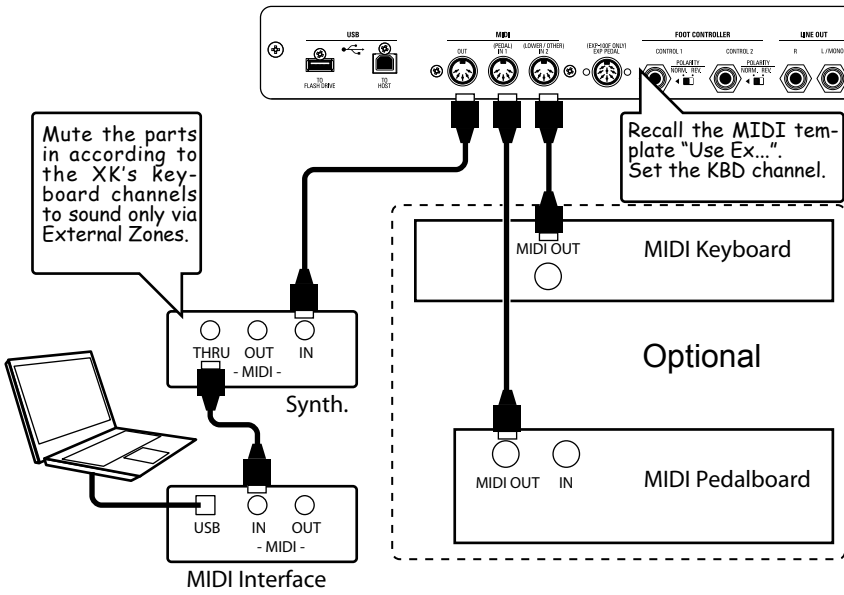

1. Select the MIDI template "Use Ex..." in according to your environment.
2. Set the Keyboard channels (Tx and Rx) for Upper, Lower and Pedal. Because the Keyboard channels were set at "Off" automatically by "Use Ex".
3. Set the MIDI channels of the synthesizer which only recognize the External Zone channel, making sure you do not copy the KEYBOARD channels.
4. The sequencer/DAW records both Keyboard channels and External Zone channels.

◆ Playback the performance

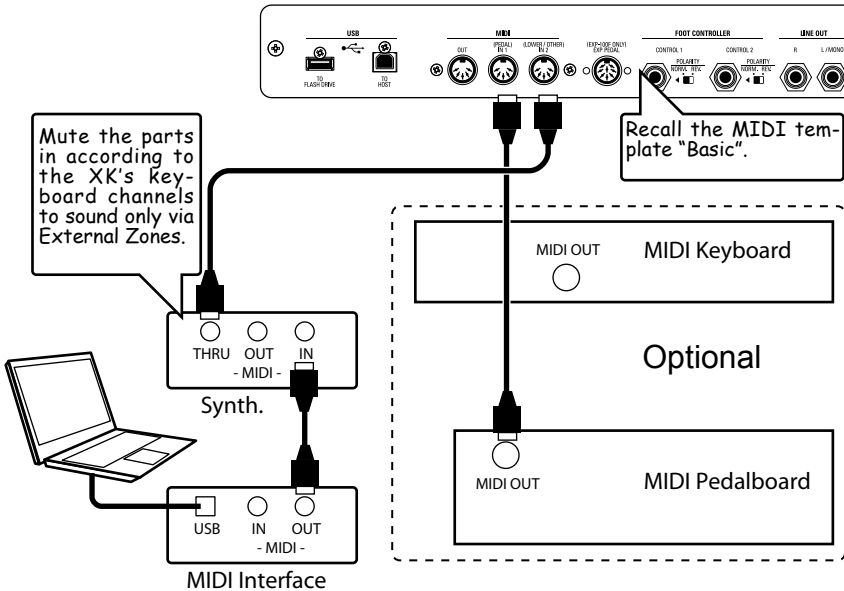

The sequencer/DAW playbacks both Keyboard channels and External Zone channels. This keyboard sounds with regarding Keyboard channel, and the synthesizer sounds with regarding External Zone channels.

1. Select MIDI template at "Basic".
2. Set the MIDI channels of the synthesizer which only recognize the External Zone channel, making sure you do not copy the KEYBOARD channels.

◆ Recording the performance including External Zones over USB

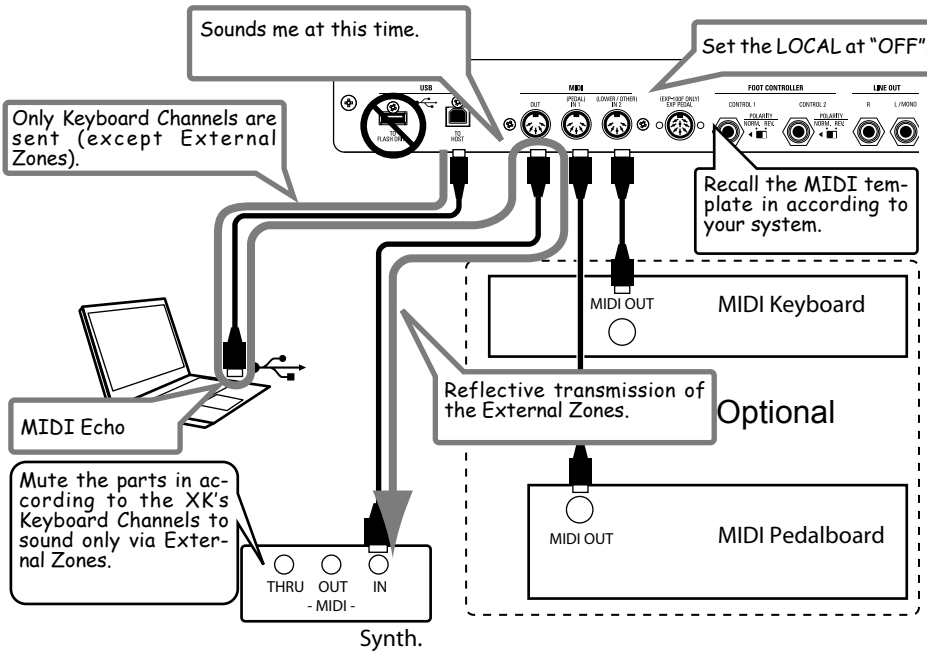

NOTE: To avoid the noise, remove the USB Flash memory during using USB audio.

It is not necessary the re-hook up the MIDI cables when switching record/playback by connecting this keyboard to the computer with USB cable.

With switch "OFF" the local control, receiving MIDI information on Keyboard channel are used as "local", and are transmitted each External Zone.

1. Set the MIDI template at "Use Ex. xxx" in according to your environment.
2. Set the Keyboard channels (Tx and Rx) for Upper, Lower and Pedal. Because the Keyboard channels were set at "Off" automatically by "Use Ex".
3. Set the local control at "OFF".
4. Set the echo of the sequencer/DAW at "ON" (no effect MIDI channel).
5. Set the MIDI channels of the synthesizer which only recognize the External Zone channel, making sure you do not copy the KEYBOARD channels.
6. Record on the sequencer/DAW ONLY Keyboard channels.

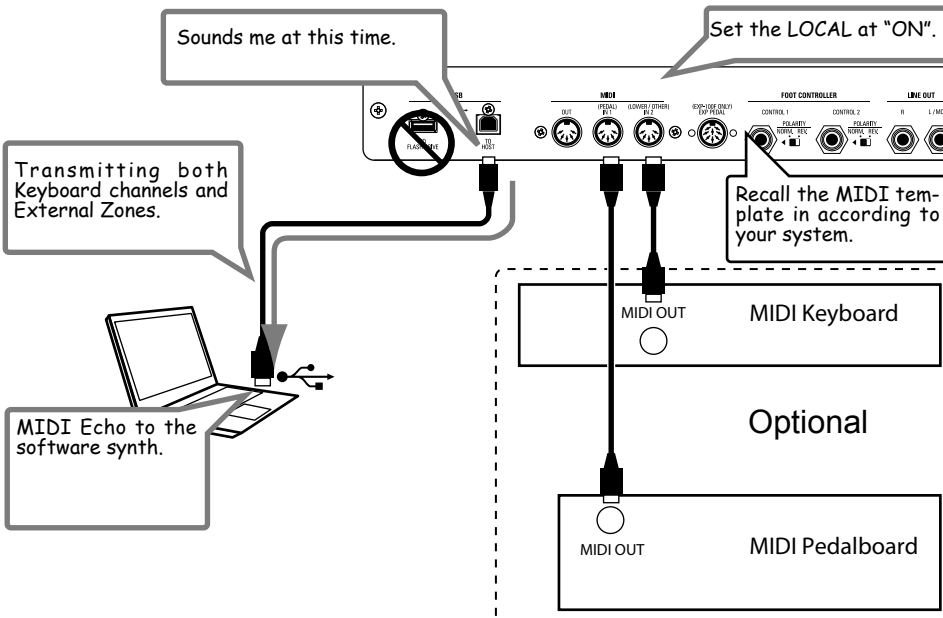

If the synthesizer which you wish to control by External Zone is in the computer, set the local control of this keyboard at "ON".

The performance information will send the External Zones with the [LOCAL] control is switched "on".

1. Select the MIDI template "Use Ex. xxx" in according to your environment.
2. Set the Keyboard channels (Tx and Rx) for Upper, Lower and Pedal. Because the Keyboard channels were set at "Off" automatically by "Use Ex".
3. Set the local control at "ON".
4. Set the echo of the sequencer/DAW at "ON" to sound the software synthesizer.
5. Record on the sequencer/DAW BOTH Keyboard channels and External Zone channels.

This keyboard equipped our exclusive standard **H-BUS** which transmits performance information and carries the power supply.

Use **H-BUS** cable only for this jack. The connectors of this cable are different style between upstream or downstream like the microphone cable.

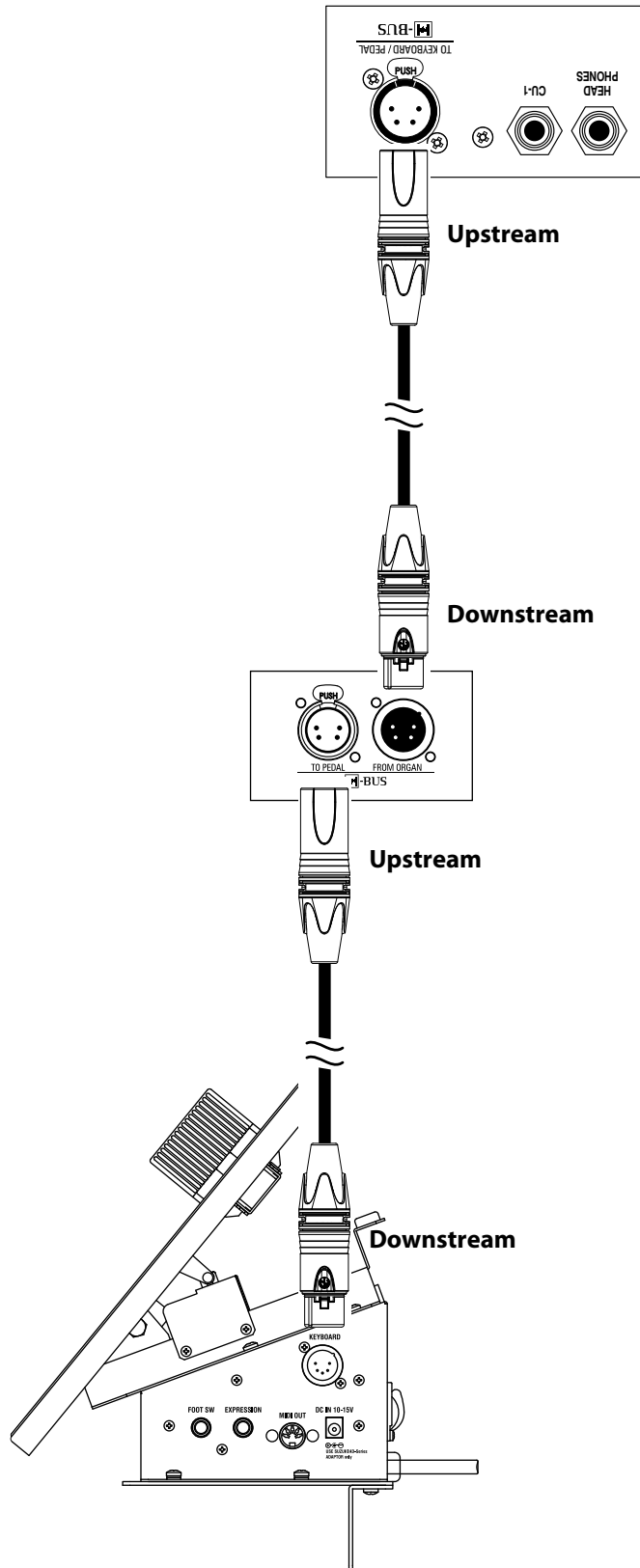

ZONES

To control external MIDI equipment, ranges on the keyboard of this instrument are assigned. They are called “External Zones”.

The range of the built-in sound engine on this keyboard (called “Internal Zone”) is set at the same time. You can use each separately on a single manual keyboard.

Each MIDI keyboard connected to the MIDI IN jack can control the external MIDI equipment with the external zone.

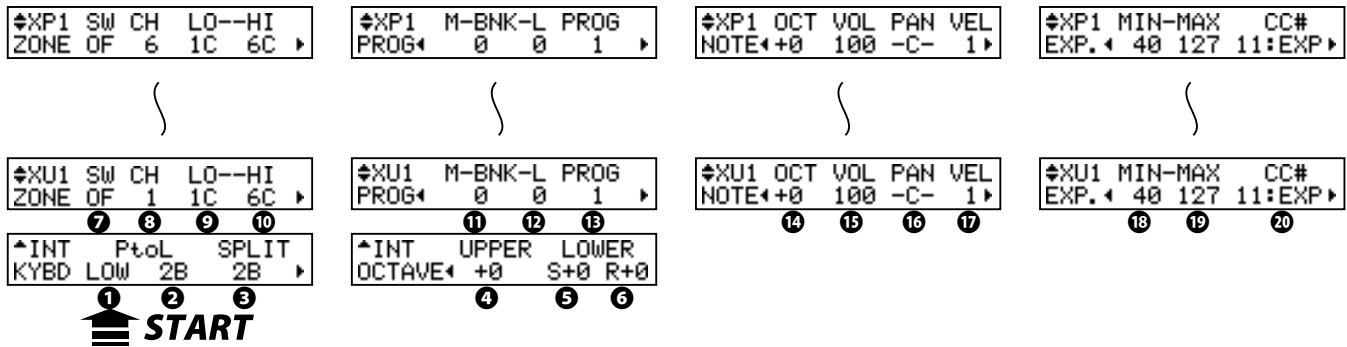

◆ WHAT IS DISPLAYED ON THE UPPER LEFT?

On the upper left of the Zones mode, the Zone to be operated now is displayed.

- INT:** Internal zone
- XUn:** External zone (Upper #n) 1 to 3
- XLn:** External Zone (Lower #n) 1 to 2
- XPn:** External Zone (Pedal #n) 1

◆ INTERNAL ZONE

① PEDAL TO LOWER - MODE

This sets the how the Pedal To Lower (P. 59) works.

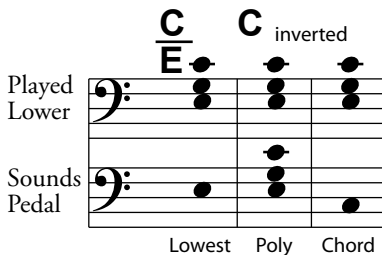

- LOW:** Sounds on lowest note if a chord is played.
- CHRD:** Sounds suitable bass note if a chord is played on Lower part.
- POLY:** Sounds the chord if a chord played.

② PEDAL TO LOWER - LIMIT

Sets the upper limit note for the Pedal To Lower function.

③ SPLIT POINT

Sets the upper limit note for the Lower part when using the split function (P. 58).

④ OCTAVE - UPPER

Sets the octave of the Upper part.

⑤ OCTAVE - LOWER on SPLIT

This is for setting the octave of the Lower part. This parameter works on split Lower division of built-in keyboard.

⑥ OCTAVE - LOWER on REAL

This is for setting the octave of the Lower part. This parameter works on expanded Lower keyboard.

◆ EXTERNAL ZONE

⑦ SWITCH

Sets whether or not to send the MIDI message in this zone.

⑧ MIDI CHANNEL

Sets the MIDI send channel 1 to 16 of this zone.

⑨ ZONE - LOW

Sets the keyboard range for playing this zone.

⑩ ZONE - HIGH

Set the lower limit with LO and the upper limit with HI.

NOTE: 9 and 10 can also be set by pressing the [RECORD] button with play the desired note on the keyboard.

⑪ PROGRAM - BANK MSB

⑫ PROGRAM - BANK LSB

⑬ PROGRAM - PROGRAM CHANGE

Sets Bank Select and the Program Change to send to this zone.

Generally, switching the tone of an external synthesizer or sampler is set by changing the Bank Select and the Program Change. Please consult the owners manual of your MIDI equipment to obtain the proper settings for Bank and Program change.

You can select the Bank MSB and LSB at 0 to 127, the Program Change at 1 to 128.

⑭ NOTE - OCTAVE

Sets octave shift of this zone. If an external synthesizer sound in a different octave from that you desire, adjust this parameter.

The setting range is -2 to +2.

◆ **To locate this mode:**

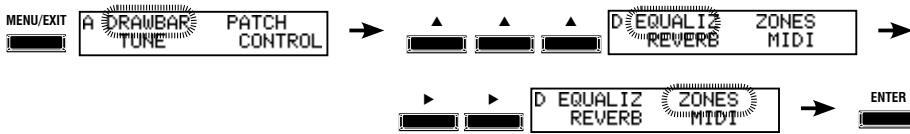

See “Function mode” (P. 68) for operation details.

◆XP1 DAMPER
MSGS4 ON EXP



◆XU1 DAMPER
MSGS4 ON EXP

21

15 **NOTE - VOLUME**

Sets the volume (Control Change #7) of this zone. However, if CC# (20) is at “VOL”, this setting value is null.

16 **NOTE - PAN**

Sets the Pan of this zone (Control Change #10).

17 **NOTE - VELOCITY**

Sets the character of the velocity to send to this zone.

The setting range is OF and 1 to 4. At OF, the velocity is fixed at 100. The “touch” (velocity response) of the keyboard progresses from 1 (heavier) through 4 (lighter).

18 **EXPRESSION - MINIMUM**

19 **EXPRESSION - MAXIMUM**

Sets the range to “compress” the expression information to send to this zone.

In the XK-5 default, if the expression pedal is pulled fully back, the output does not perfectly silent. If a GM sound generator is used, the volume would go to zero. This is a parameter to balance the two.

The setting range is MIN at 0 to 63, MAX at 64 to 127.

20 **EXPRESSION - CONTROL NUMBER**

Volume control differs by type by type of MIDI equipment connected. This parameter sets the proper CC# to control the volume / expression of connected MIDI equipment.

You can select 7: VOL, 11: EXP.

21 **MESSAGE - DAMPER**

Sets which controller to send the damper information to this zone.

- OFF:** Does not send.
- CTRL1:** A foot controller which connected CTRL1 jack.
- CTRL2:** A foot controller which connected CTRL2 jack.
- ON EXP:** The foot switch which placed on the Expression pedal.

NOTE: The parameters in these modes are Patch parameters, and are recorded to the Patch.

◆ **MESSAGE ON/OFF**

The MIDI messages which this keyboard transmits may make undesired operation. This can be prevented by switching off the appropriate MIDI message.

MIDI message which can switched Patch by Patch

Note, Expression, Damper(in this page)

MIDI message which switched by totally

Bank select, Program change, Volume, Pan (P. 128)

◆ **PANIC FUNCTION AND PARAMETER RE-LOAD**

Rarely, when MIDI equipment is attached, certain “Glitches” may occur such as a “Stuck note” or “Cipher”. This is not cause for alarm, and is usually not an indication of serious malfunction. Glitches like this may be remedied by sending a “Panic” Message which should clear the Cipher.

In such a case, touch both [▲], [▼] buttons. Both the “All Note Off” and “Reset All Controllers” are sent to the MIDI channels of all external zones (Panic Function), then the settings of all external zones are reloaded (sent again).

In this mode, you make the basic MIDI settings and the memory dump operation.

◆ To locate this mode:

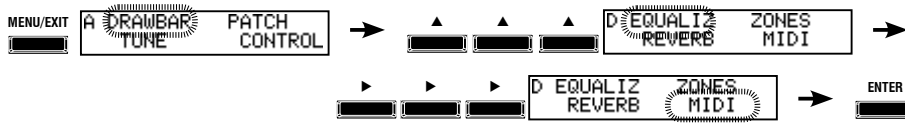

See “Function mode” (P. 68) for operation details.

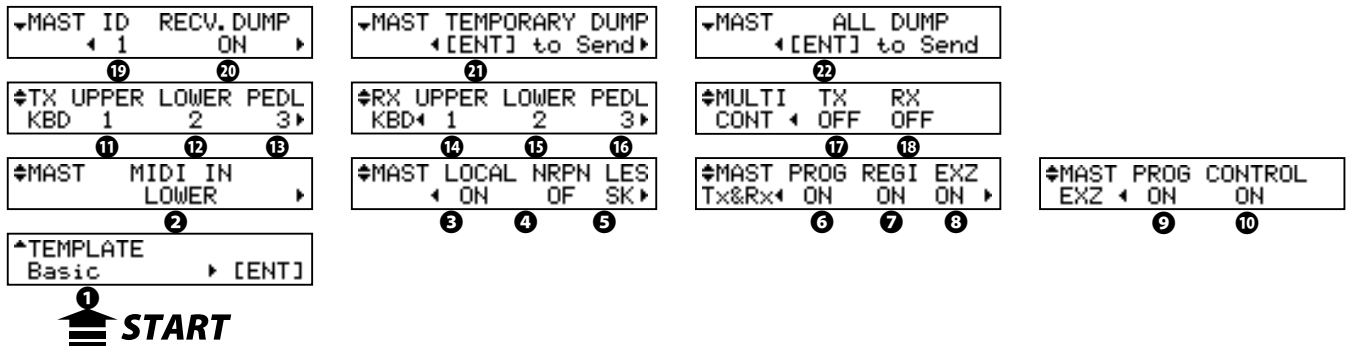

◆ MIDI TEMPLATE

1 MIDI TEMPLATE

This mode allows common MIDI setups to be recalled.

By selecting the use with the [◀][▶] buttons and pressing the [ENTER] button, the typical settings are called.

See “MIDI TEMPLATE” in the Appendix (P. 148) for details of each MIDI template.

◆ MASTER

2 MIDI IN

This is for switching the MIDI IN LOWER/OTHER jack function.

MIDI IN PEDAL jack works as PEDAL part with regardless of this parameter.

SEQUENCE:

The received MIDI data sounds the UPPER, LOWER and PEDAL parts in accordance with the MIDI channel settings. They are not re-sent.

LOWER:

The received MIDI data sounds the LOWER part and are re-sent to the LOWER channel (#12) of the MIDI OUT jack, regardless of the settings of the MIDI channel.

The [SPLIT] button is ignored. Its keyboard works as UPPER.

UPPER:

The received MIDI data sounds the UPPER part and are re-sent to the UPPER channel (#11) of the MIDI OUT jack, regardless of the settings of the MIDI channel.

The [SPLIT] button is ignored. Its keyboard works as LOWER.

3 LOCAL

This switches the Local Control ON/OFF.

ON: Connects between “internal keyboard and sound engine” and “internal keyboard and External Zones”.
Received MIDI message on the Keyboard channel are used only for sounding, it does not re-send.

OFF: Disconnects between “internal keyboard and sound engine” and “internal keyboard and External Zones”.

Received MIDI messages on the Keyboard channel are re-sent by External Zones.

4 NRPN

This switches the NRPN (Non-Registered Parameter Number) ON/OFF.

On this keyboard it is used for transmitting the messages such as Drawbar Fold Back or Leslie ON. The NRPN is transmitted through the UPPER channel.

When switched ON, it is transmitted. When OFF, not transmitted.

5 LESLIE

This is for controlling how to send Leslie Parameters. The Leslie Parameters are sent on UPPER Channel.

XX: The Leslie Parameters will be sent out on this keyboard original NRPN address and data.

21: The Leslie Parameters will be sent out for Leslie 21 series NRPN address and data.
When the Cabinet Number is selected (i.e. by Patch), the parameters are sent out also.

NOTE: This parameter will change automatically when the Leslie speaker is connected / disconnected.

6 PROGRAM CHANGE

This switches the Program Change transmission ON/OFF. When ON, transmitted. When OFF, not transmitted.

7 DRAWBAR REGISTRATION

This switches the Drawbar Registration transmission ON/OFF. When ON, transmitted. When OFF, not transmitted.

8 EXTERNAL ZONE - WHOLE

This switches the External Zones transmission as a whole ON/OFF. When ON, transmitted. When OFF, not transmitted.

9 EXTERNAL ZONE - PROGRAM CHANGE

This switches the transmission of the Program change and Bank select for all the External Zones.

10 EXTERNAL ZONES - CONTROL CHANGE

This switches the transmission of the Volume and Pan for all the External Zones.

Other parameters are set at ZONES function mode such as Note, Expression and Damper.

◆ KEYBOARD CHANNEL

Sets the MIDI channel to transmit at each part. The setting range is 1 to 16 and OF. At OF there is no transmission.

11 TX UPPER

Sets the MIDI channel for sending the UPPER part playing information, the control information, and that of the Leslie speaker.

12 TX LOWER

Sets the MIDI channel for sending the LOWER part playing information.

13 TX PEDAL

Sets the MIDI channel for sending the PEDAL part playing information.

14 RX UPPER

Sets the MIDI channel for receiving the UPPER part playing information, the control information, and that of the Leslie speaker.

15 RX LOWER

Sets the MIDI channel for receiving the LOWER part playing information.

16 RX PEDAL

Sets the MIDI channel for receiving the PEDAL part playing information.

17 TX MULTI CONTACT**18 RX MULTI CONTACT**

These sets whether sending/receiving the playing information of the multi-contacts.

When ON, each contact information are transmitted by below list regardless of above MIDI channels #11 to #16.

Physical Contact	MIDI Channel
UPPER, First	1
UPPER, Second	2
UPPER, Third	3
LOWER, First	4
LOWER, Second	5
LOWER, Third	6
PEDAL, All	7

NOTE: To avoid confusion of MIDI signals, set each MIDI channel including the external zones (P. 126) to different numbers.

◆ SYSTEM EXCLUSIVE MESSAGE**19 DEVICE ID**

This sets the Device ID when transmitting the system exclusive messages such as the Memory Dump (#21, 22). The receiving is neglected, when the Device ID does not match, even if the messages for the same model.

20 RECEIVE DUMP

This switches reception of Memory Dump ON/OFF.

On this keyboard the total onboard memory can be transmit-

ted as system exclusive messages via Memory Dump. To prevent reception of Memory Dump, select OFF.

21 TEMPORARY DUMP

Sends the Memory Dump.

When you press the [ENTER] button in this mode, the present settings (see tips) are sent as a whole from the MIDI OUT and USB TO HOST jack.

Recording a Temporary dump before you record a performance to an external sequencer, avoids setting mismatching upon sequencer playback.

22 ALL DUMP

Sends the Full Memory Dump.

Pressing the [ENTER] button in this mode, transmits all the settings through the MIDI OUT and USB TO HOST jack.

NOTE: The settings in this mode are not recorded to the Patches. They are recorded upon setting, and are common at all Patches.

tips TEMPORARY DUMP CONTENTS

The Patch parameters, Global parameters and System parameters of the Temporary (= the present setting values) are transmitted.

The contents of each Patch or that of the Leslie Cabinet are not transmitted. Use 'All Dump' for saving them.

tips TO SAVE ALL

All the setting values of this keyboard are transmitted by 'All Dump'.



SAVE YOUR SETUP

You can save the total settings of this unit as “Set Up Files”. Use the USB Flash Drive to insert to the USB jack on the back or the built-in internal memory.

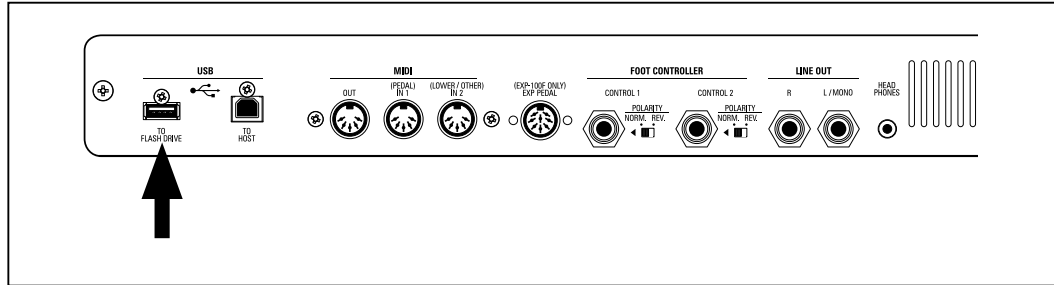

WHAT YOU CAN DO WITH THE USB FLASH DRIVE

- ◆ Save / Restore the set-ups of this keyboard.
- ◆ Save / Load a patch.
- ◆ the capacity of 1 set-up file is 275K bytes.
- ◆ 1 USB flash drive can save up to 99 set-up files.
- ◆ 1 USB flash drive can save up to 99 patch files, too.

ABOUT USB FLASH DRIVE

◆ USABLE USB FLASH DRIVE

There are various types of USB Flash Drives. Not all will necessarily work with this keyboard. The rough estimate is 32GB or less, and formatted with MS-DOS FAT32. Consult our web site about compatible USB Flash Drives.

in Europe: <http://www.hammond.eu>

in The US: <http://www.hammondorganco.com>

◆ USB CONNECTOR

1. Insert the USB Flash Drive facing the correct direction, matching the upper side of it to that of this keyboard.
2. Do not remove the USB flash drive or switch OFF the power while accessing data (= while the “Please wait.” is displayed). Data may be damaged.

◆ FOLDER STRUCTURE

When the USB Flash Drive is inserted to this organ, the following folders are automatically created on the drive.

1. “hammond” - “xk5” in the root folder.
2. “setup”, “system” below it.

setup

The setup files are saved here.

system

Place the system files to update this keyboard here.

NOTE: If your USB drive is formatted so the XK-5 cannot read it, the XK-5 displays an error message.

A “fresh” The USB flash drive must be “initialized”. The initializing procedure is as follows:

NOTE: When initializing is completed, all the contents of the USB flash drive are erased.

① INSERT THE USB FLASH DRIVE

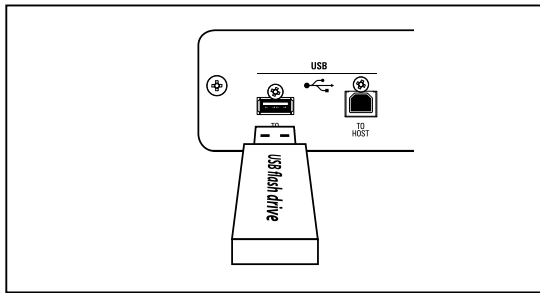

Insert the USB flash drive to the USB FLASH DRIVE jack.
Wait until the display “Confirming USB. Please wait...” disappears.

② LOCATE THE FORMAT FUNCTION MODE

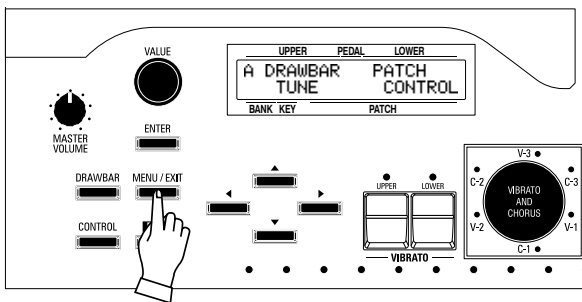

Press the [MENU/EXIT] button to display the Menu.

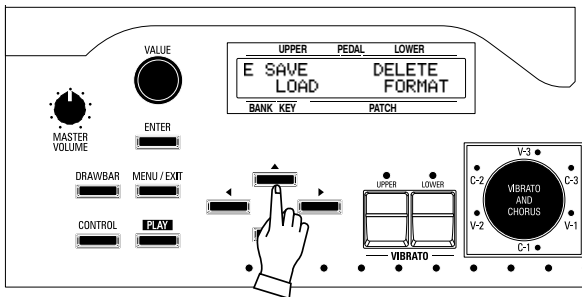

Select Page E with the [▲],[▼] buttons.

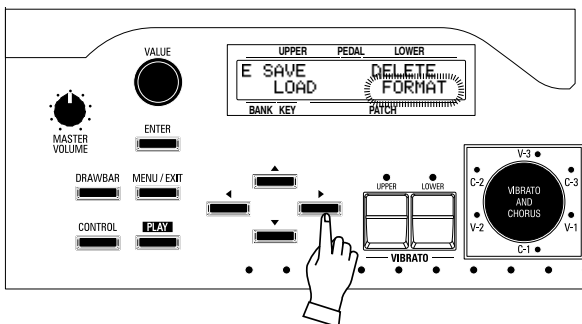

Select the “FORMAT” with the [▶] button.

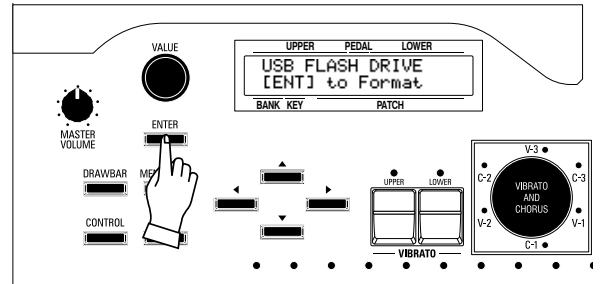

Press the [ENTER] button.
The FORMAT (=initializing) mode is located.

③ CONFIRM

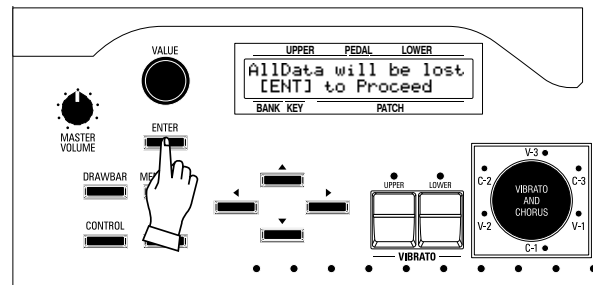

Press the [ENTER] button.
Confirmation message is displayed.

④ DECIDE

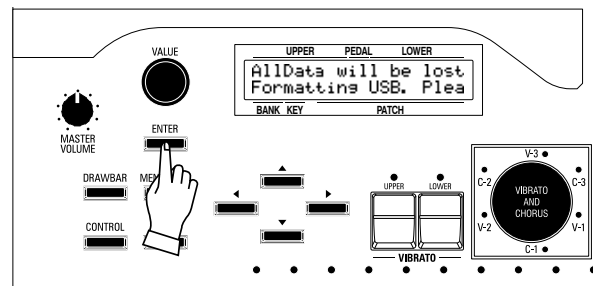

Press the [ENTER] button.
Initialization starts. It takes about 3 seconds.
NOTE: If you choose to not initialize, just press the [MENU/EXIT] button.

⑤ FINISHED

To return to the play mode, press the [PLAY] button.

A SETUP FILE

The various setting is saved a file which called "Setup File".
 A Setup file contains shown below;

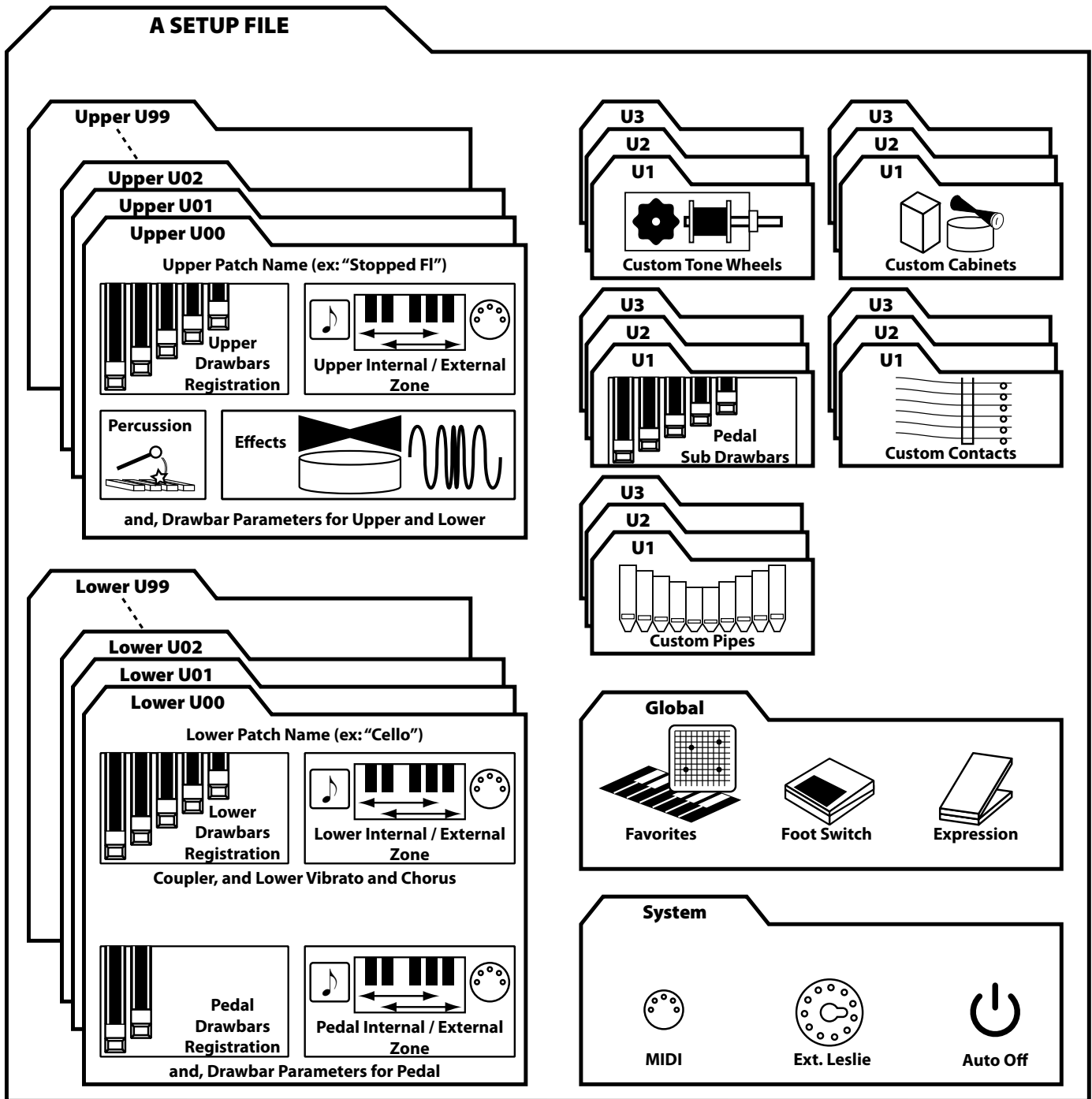

- ♦ The save procedure is on Setup unit. You cannot an element of Setup when saving.
- ♦ The elements (such as Custom Tone Wheel, Patches, ...) may be Loaded separately from the entire setup.

WHAT IS USB MASS-STORAGE?

This unit has, in addition to the USB Flash Drive, a built-in “INTERNAL MEMORY” for saving the Set Up Files.

The Internal Memory can, not only save/read, same as the USB Flash Drive does, exchange the files via the computer and the USB cable. It is called “USB Mass-Storage”.

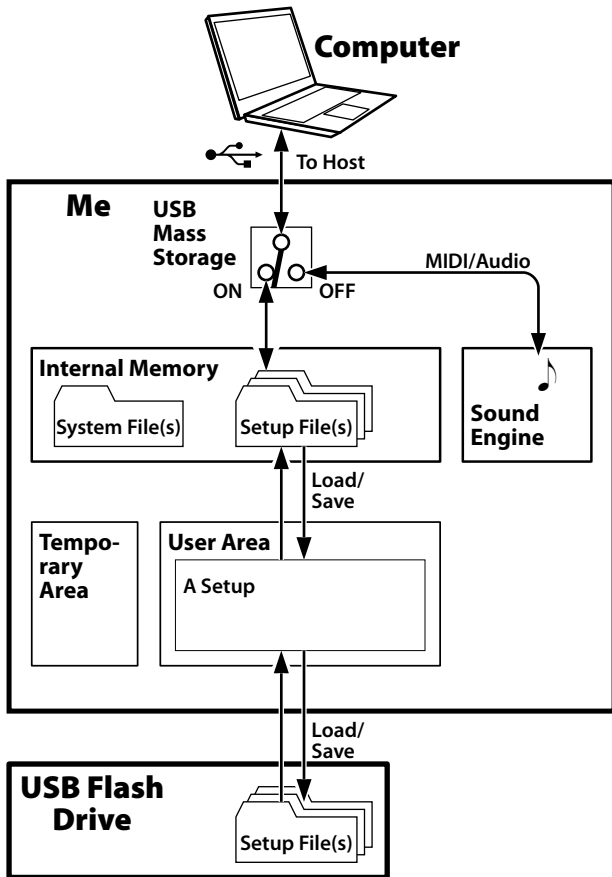

SWITCHING THE FUNCTION OF USB-TO-HOST JACK

The USB TO HOST jack is usually used for transmitting (sending and receiving) MIDI and Audio Stream to the computer.

To exchange the Internal Memory Files, turn on the USB MASS STORAGE. (See the top of the left illustration.)

NOTE: You cannot transmit MIDI or Audio Stream while you are using USB MASS STORAGE.

① LOCATE THE MASS STORAGE MODE

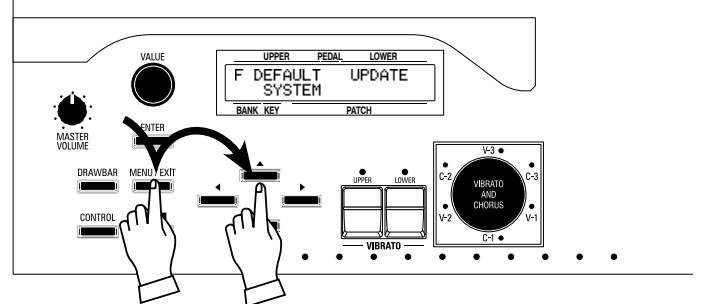

Press the [MENU/EXIT] to display the Menu mode, select the page F - “SYSTEM” by using [▲] button.

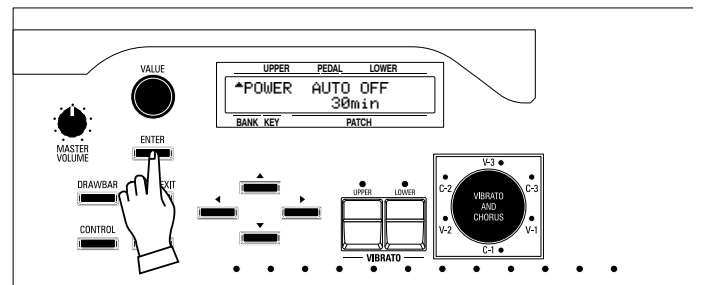

Press the [ENTER] button. SYSTEM function mode is located.

② SWITCH THE MODE

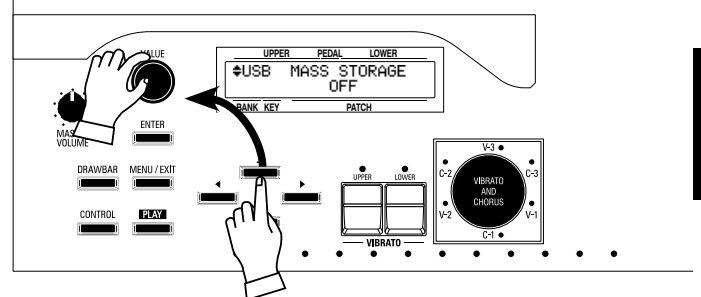

Select the “USB” page by using [▲] button. Switch “ON” or “OFF” of whether using Mass Storage by [VALUE] knob.

SAVE THE SETUP

In this mode, save the Setup file into the USB Flash Drive or Internal Memory.

◆ **To locate this mode:**



HOW TO READ THE DISPLAY

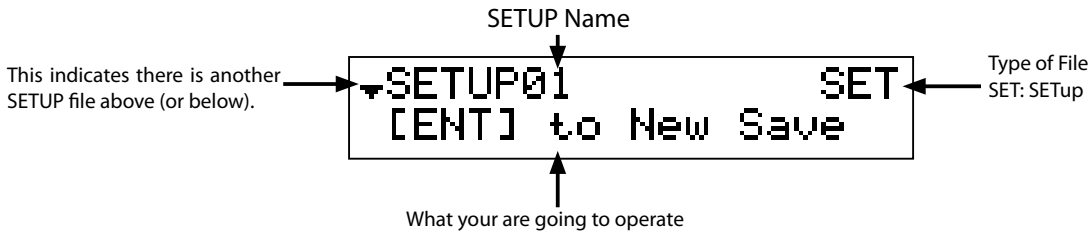

SAVE THE SETUP

① INSERT THE USB FLASH DRIVE

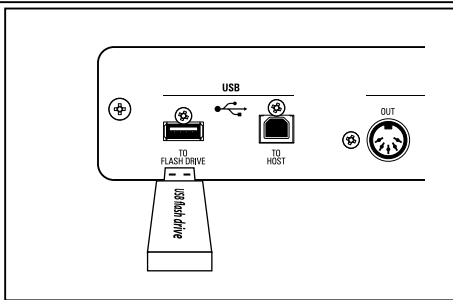

When you save Set Ups to the USB Flash Drive, make sure the USB Flash Drive is correctly inserted. If not correctly inserted, the Setups are saved to the Internal Memory.

③ SAVE AS NEW FILE

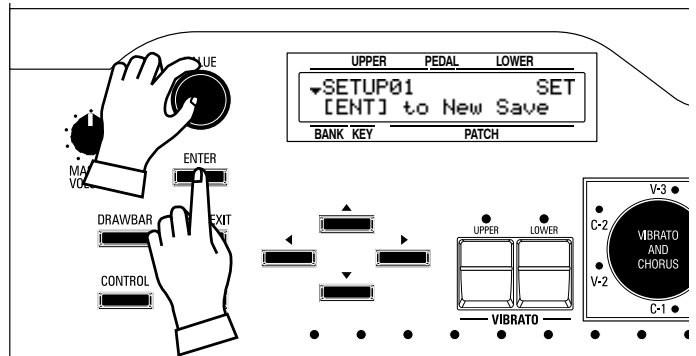

Select the "New Save" by using [▲] button at several times or [VALUE] knob, press the [ENTER] button to decide.

② CHOOSE THE MEDIA TO SAVE

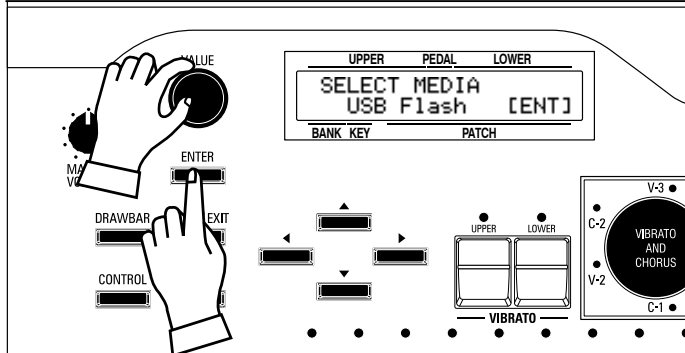

When you locate the SAVE mode, you are first asked to which media you want to save the file.

Select the USB Flash or INTERNAL MEM with the [VALUE] knob and decide with the [ENTER] button.

NOTE: If the USB Flash Drive is not inserted, this step does not appear.

◆ OVERWRITE RECENT FILE

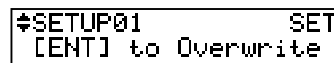

Select the file which wish to overwritten by using [▲] button at several times or [VALUE] knob, press the [ENTER] button to decide.

4 INPUT THE FILE NAME

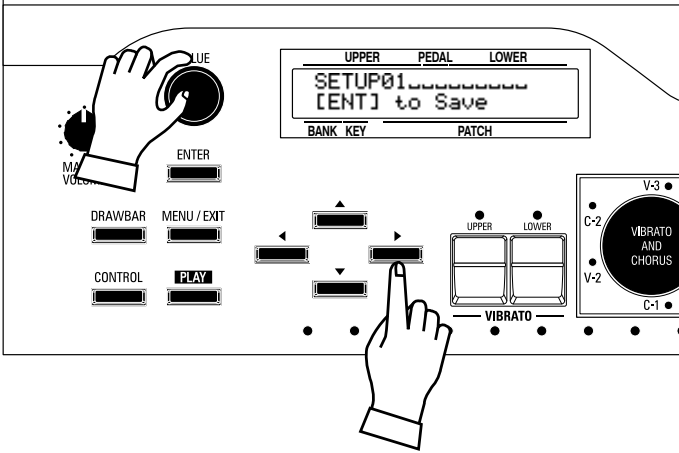

Input the Setup file name.

Go to the next step if you wish to create your own name, instead of the entry named automatically. To name the Setup file, use [◀][▶] to select the cursor and [VALUE] to select the letter.

5 DECIDE

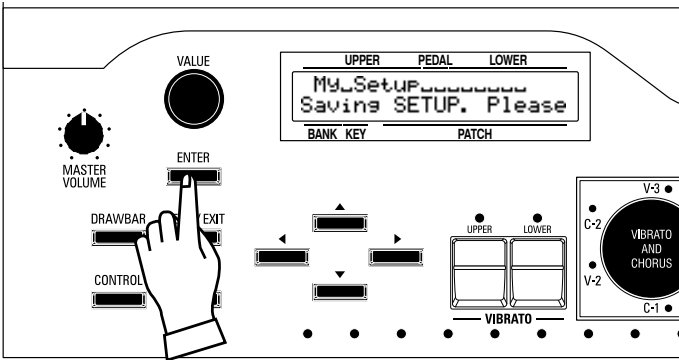

Press the [ENTER] button to save.

```

My Setup      SET
[ENT] to Overwrite
    
```

The setup procedure is finished, the display shows Setup file name.

Press the [PLAY] button to return to the Play mode.

tips FILE NAME AND SETUP NAME

If you wish to change the Setup name, do not rename it on the computer. Please save with new name on the XK-5.

The XK-5 saves the setup file with its own file name, which is not visible on your computer. Changing the setup name on the computer will not change the file name, and may cause an error in reloading or file maintenance.

LOAD THE SETUP

Load the Setup from USB Flash Drive or Internal Memory into user area.

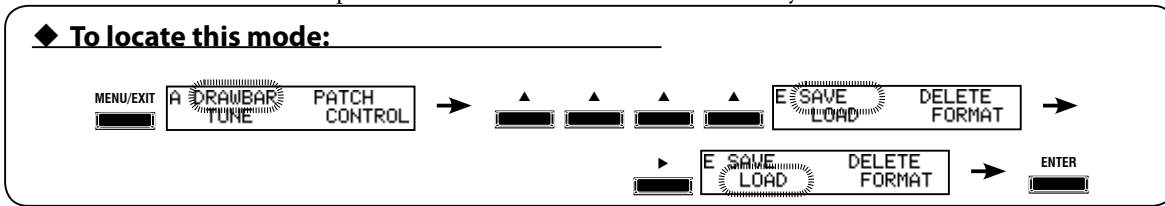

HOW TO READ THE DISPLAY

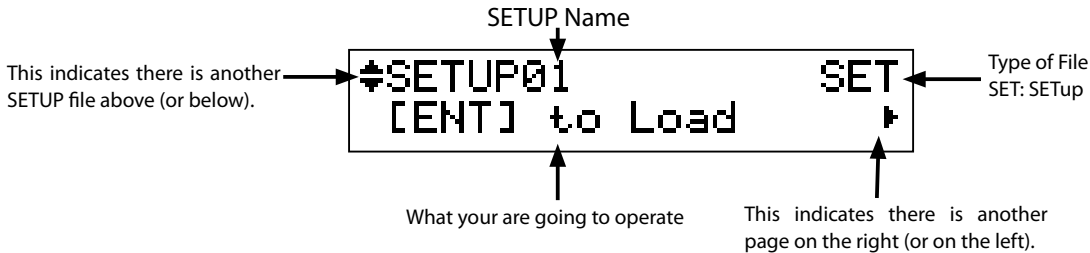

LOAD THE SETUP

NOTE: If you do this operation, the settings in this keyboard are replaced with the newly loaded setups. You should save important data beforehand (P. 136).

① INSERT THE USB FLASH DRIVE

When you recall the Setups from the USB Flash Drive, check that the USB Flash Drive is correctly inserted. If not inserted, the Setups are recalled from the Internal Memory.

② CHOOSE THE MEDIA TO LOAD

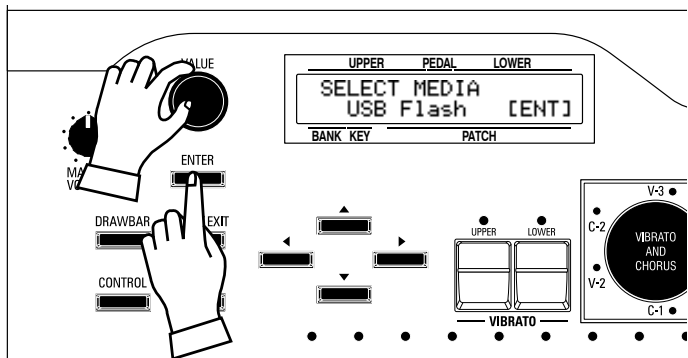

When you locate the LOAD mode, you are first asked where you want to load the file.

Select the USB Flash or the INTERNAL MEM with the [VALUE] knob and decide with the [ENTER] button.

NOTE: If the USB Flash Drive is not inserted, this step does not appear.

③ CHOOSE A FILE

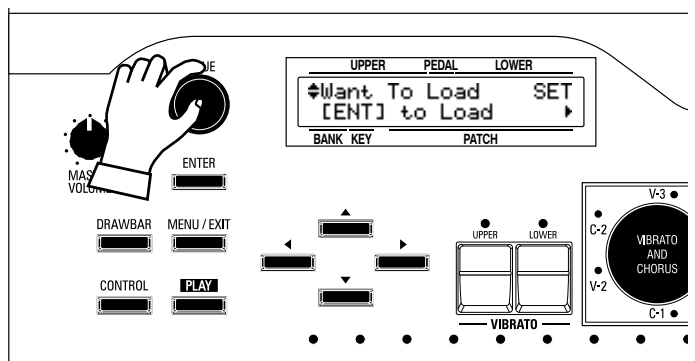

Choose the Setup file to recall using [▼]/[▲] buttons or [VALUE] knob.

④ ALL OR SPECIFIC ITEM

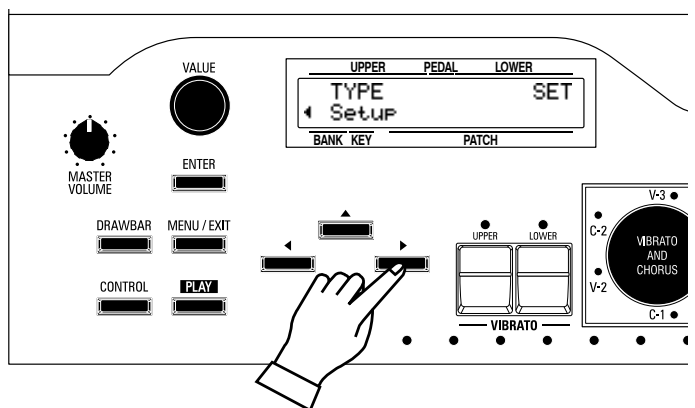

When you want to recall all the contents of a Setup File, go to Step 7.

To recall a specific item in the Setup File, touch the [▶] button and locate the TYPE page.

5 SELECT THE PARAMETER

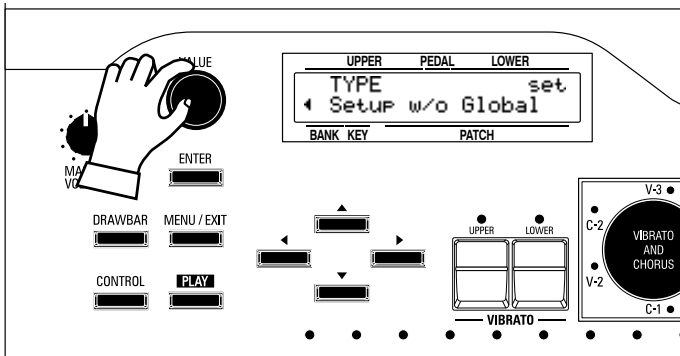

Select the parameter which wish to load (see P. 134) by [VALUE] knob.

6 RETURN TO PREVIOUS PAGE

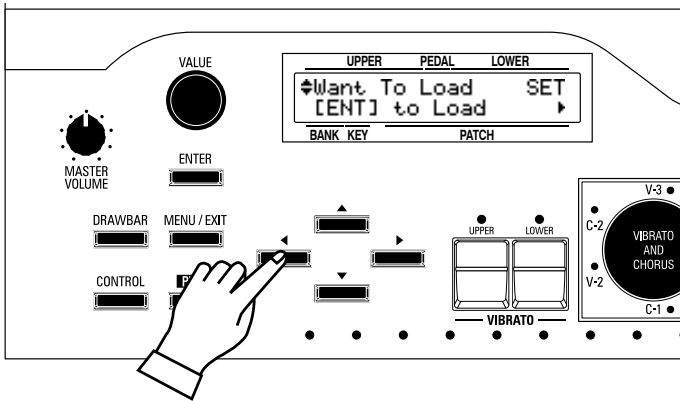

Press the [◀] button to return to the previous page.

7 DECIDE

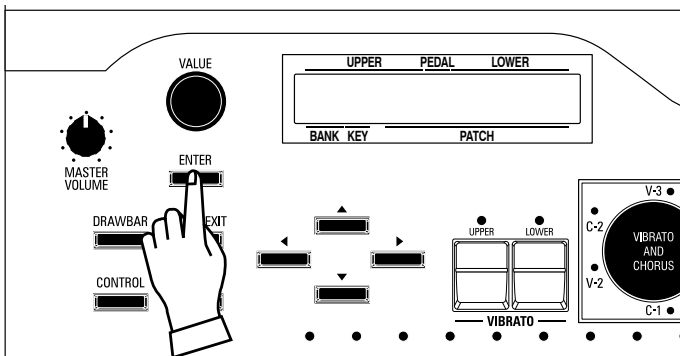

Press the [ENTER] button to decide.

8 SELECT THE PATCH

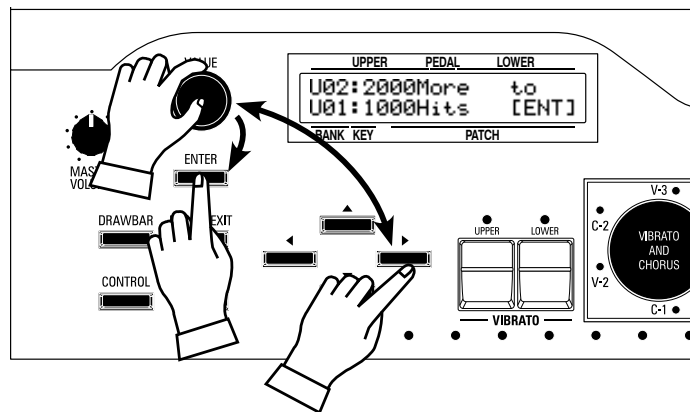

If you have selected the Patch in Step 5, the page will appear as above.

Set with the [◀]/[▶] button and the [VALUE] knob “To which Patch number do you want to recall the Patch in this Setup File?” and press the [ENTER] button.

9 LOAD BEGINS

The loading Setup file is begin with showing “Loading9 xxx. Please wait”.

10 LOAD FINISHED

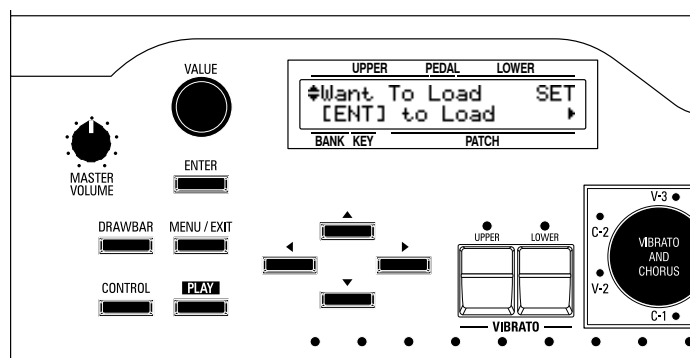

The display shows Setup file name again when the load procedure is finished.

Press the [PLAY] button to return to the Play mode.

tips HOW TO USE “w/o Global”

The “Setup w/o Global” of the file type option loads that “all the contents in the Setup file except Global and System parameters”. This is useful for exchange the Setup file between users whose has different environment such as foot controllers or extended keyboard.

DELETE THE SETUP

To delete the Setup file in the USB Flash Drive or Internal Memory at DELETE function mode.

◆ **To locate this mode:**

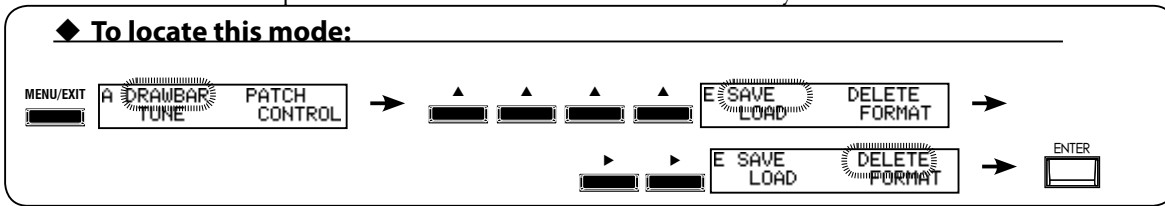

HOW TO READ THE DISPLAY

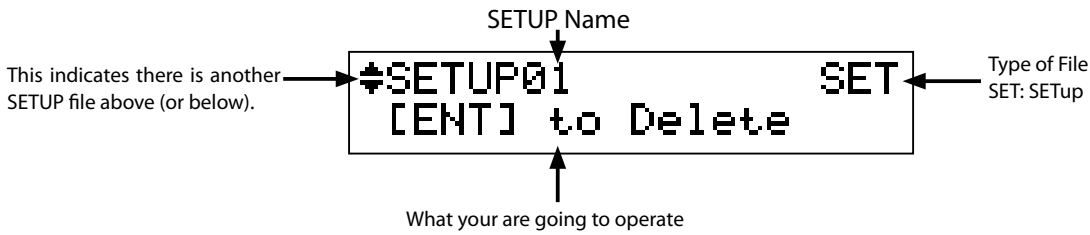

DELETE THE SETUP

① INSERT THE USB FLASH DRIVE

Make sure that USB Flash Drive is correctly inserted if you wish to delete the Setup file in it. If the USB Flash Drive does not inserted, the Setup file in the internal memory will deleted.

② CHOOSE THE MEDIA TO DELETE

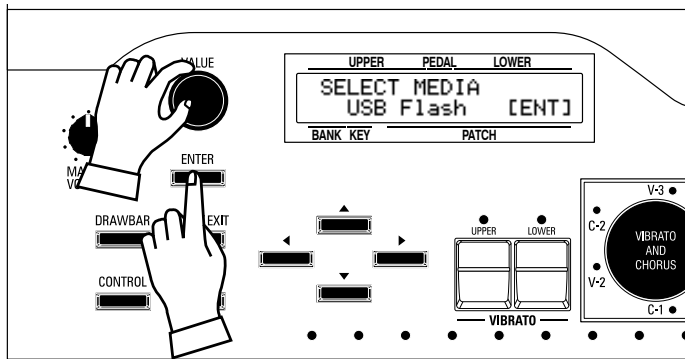

On the DELETE function mode, it asks stored media. Select the USB Flash or Internal Memory by [VALUE] knob, press the [ENTER] button to decide.

NOTE: This page does not display when the USB Flash Drive is not inserted.

③ CHOOSE A FILE

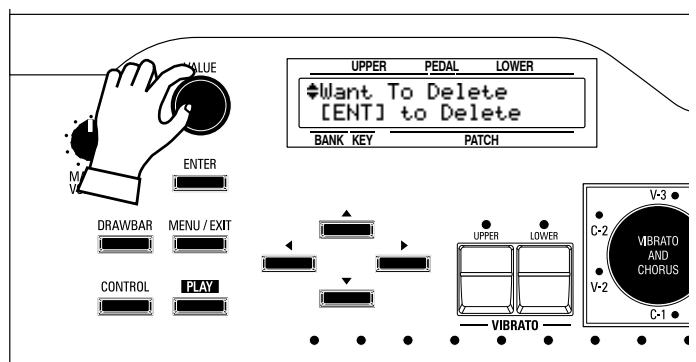

Select the Setup file which you wish to delete by [▲][▼] button or [VALUE] knob

④ CONFIRM

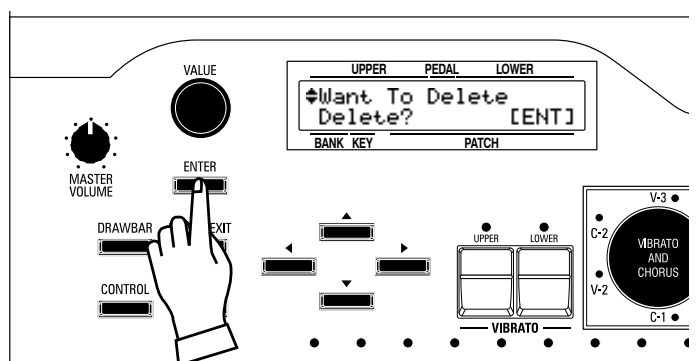

Press the [ENTER] button. "Delete?" is displayed for confirm.

5 DECIDE

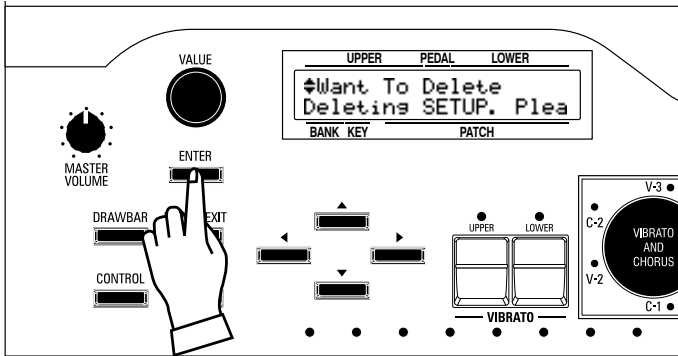

Press again the [ENTER] button to delete.

NOTE: Press the [MENU/EXIT] to exit.

6 FINISHED

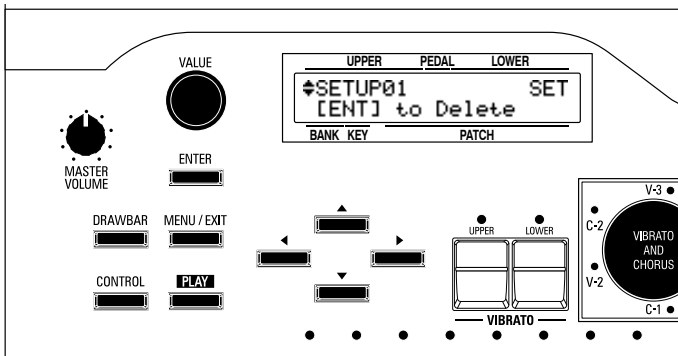

The delete procedure is finished.

Press the [PLAY] button to return to the Play mode.

UPDATE

In this mode, update the system software (hereinafter, system) in this keyboard from USB flash drive, or internal memory.

The system may updated for improving the quality or stability.

To update the system, download the updatator and load into this keyboard.

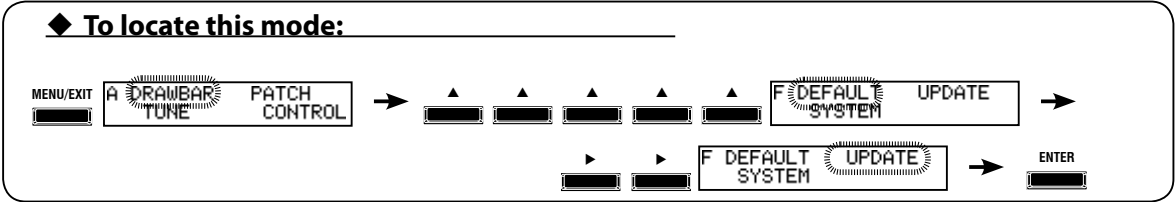

WORKING TIME AND SECURING THE POWER

Do the updating operation under the condition with enough working time and stable power secured.

The updating will take up to quarters of hours maximum. If the power is cut off during the process, this unit might not start up.

① COPY THE "SYS" FILES

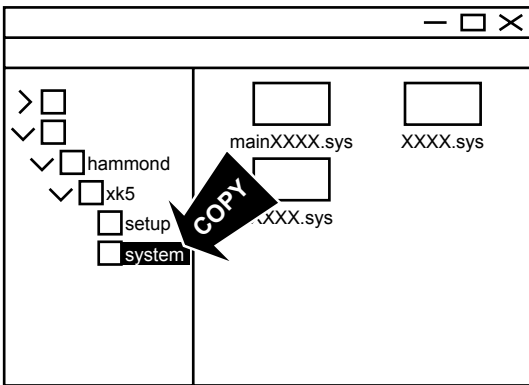

If the updatator are archived, decompress/unzip it, and copy the "sys" files to the "system" folder of the USB Flash Drive or the Internal Memory.

To compose folders which shown above figure, insert the USB Flash Drive into the XK-5 once before copy files. And wait for "Confirming USB. Please wait." is disappeared.

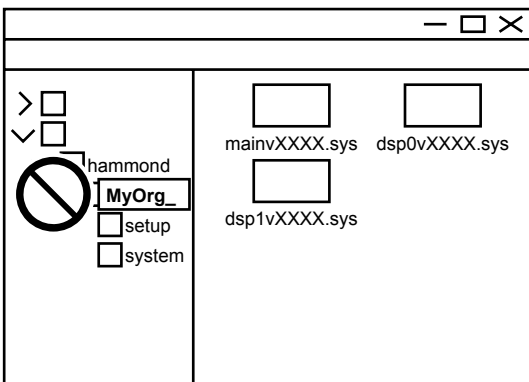

⚠ CAUTION

Do not rename, delete or format the internal memory. It causes the breakdown of the operating system.

② CHOOSE THE MEDIA THAT COPIED

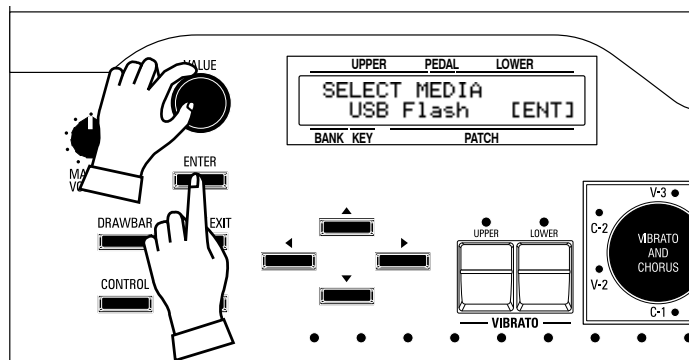

When you come to the UPDATE mode, you will be first asked to which media you want to read the updatator.

Select the USB Flash or the INTERNAL MEM with the [VALUE] knob and decide with the [ENTER] button.

NOTE: This page does not display when the USB Flash Drive is not inserted.

◆ THE UPDATOR DOES NOT FOUND

No system files.

The Updatator are not found in the selected media.

③ UPDATE BEGINS

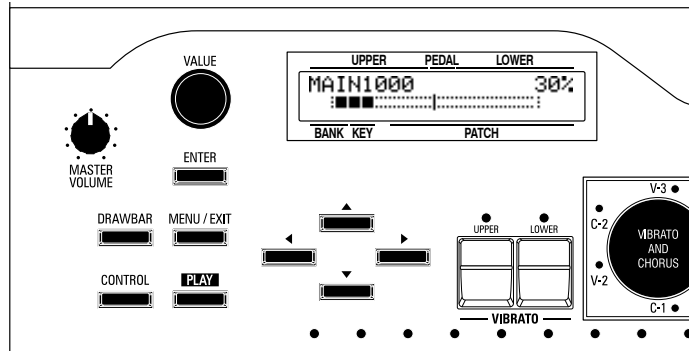

The status of the updating operation is displayed in percentage while it is in process.

4 UPDATE FINISHED

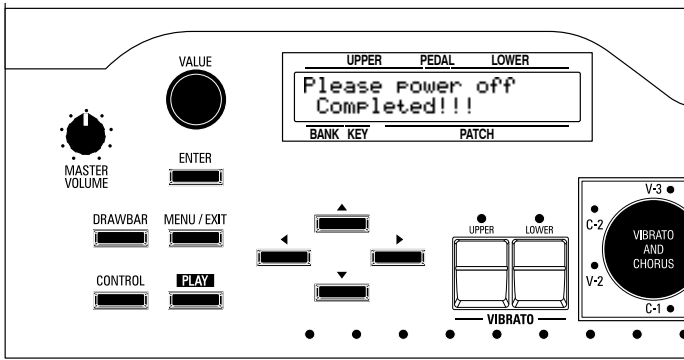

The updating process is completed when “Please power off.” is displayed.

Once turn off the power and switch on again, the unit will start up with the updated system software.



**FREQUENTLY
ASKED
QUESTIONS**

- ◆ **Malfunction of the buttons, the keys, etc.**
 - ◆ Turn off the POWER switch once, then turn it on again. If this procedure is not successful, turn off the POWER switch. While pressing the [RECORD] button, turn the POWER switch on again. (Note that in this case, all parameters all parameters return to their factory-preset status.)
- ◆ **No sound is produced when the keys are pressed.**
 - ◆ The MASTER VOLUME is at the minimum setting. ⇒
Adjust the volume with the MASTER VOLUME control.
 - ◆ The local control is turned OFF. ⇒
Turn the local control ON, if not using an external sequencer or computer (P. 128).
- ◆ **[MENU/EXIT] or [RECORD] button does not work.**
 - ◆ The display is locked. ⇒
Release display lock (P. 72).
- ◆ **Drawbars do not work.**
 - ◆ The Control Mode or Assignable Drawbars are set. ⇒
Adjust the value of each parameter which you wish (P. 80).
- ◆ **Split does not work.**
 - ◆ MIDI IN mode is set at Lower or Upper. ⇒
Set the MIDI IN mode regarding your purpose (P. 128).
- ◆ **The [PEDAL TO LOWER] coupler does not function.**
 - ◆ The foot switch is assigned at "Pedal To Lower". ⇒
Depress the foot switch, or assign another function for foot switch (P. 78).
 - ◆ Used stand-alone and does not used split. ⇒
Switch on the split (P. 58).
- ◆ **Expression does not work.**
 - ◆ Control - Expression - Source is not right. ⇒
Set the Expression - Source regarding your purpose (P. 79).
 - ◆ Overdrive - Expression is set at "OD Only" or "Input". ⇒
Set the value of the Overdrive - Expression at others (P. 101).
 - ◆ The source of the Multi Effects at "Exp". ⇒
Set the value of the source at others (P. 103).
- ◆ **Foot Switch does not work.**
 - ◆ Control - Foot Switch is not right. ⇒
Set the Control - Foot Switch at desired value (P. 78).
- ◆ **The sound is interrupted when the Patch is changed.**
 - ◆ The sound will be temporarily interrupted when Patches contain different values of the following parameters;
Organ Type, Multi Effects, Octave, Split, Pedal To Lower, Internal / External Zones.

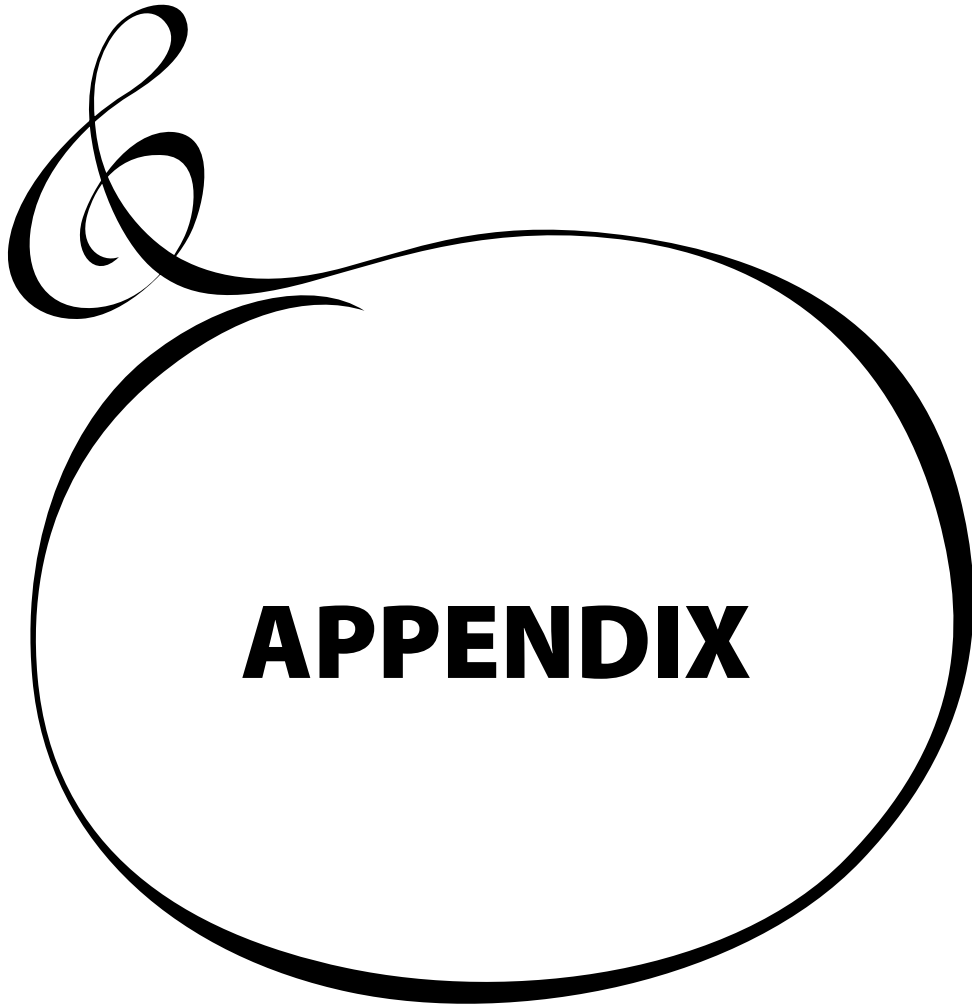

APPENDIX

MIDI TEMPLATE

MIDI TEMPLATE

Templte		Basic	2or3 KBD	SeqMContact
Messages	MIDI IN	Sequence	Lower	Sequence
	Local Control	On	On	On
	NRPN	On	On	On
	Program Change	On	On	On
	Drawbar Registration	On	On	On
	External Zone	Off	Off	Off
Transmit Channel	Tx. Upper	1	1	1(disregarded)
	Tx. Lower	2	2	4(disregarded)
	Tx. Pedal	3	3	7(disregarded)
	Tx. Multi	Off	Off	On
	Rx. Upper	1	1(disregarded)	1(disregarded)
	Rx. Lower	2	2(disregarded)	4(disregarded)
	Rx. Pedal	3	3(disregarded)	7(disregarded)
	Rx. Multi	Off	Off	On
Comments	This template is used for record / playback the performance to / from the external sequencer with pedalboard or stand-alone.		This template is used for playing this keyboard with Lower keyboard to MIDI IN OTHER jack, and Pedalboard to MIDI IN PEDAL jack.	This template is used for record / playback the performance to / from the external sequencer with XLK-5 / XPK-250W and multi-contact signal. The MIDI channels are used 1 to 9 in forced.

Template		Use Ex. Zone	Use Ex. 2or3KB	
Messages	MIDI IN	Sequence	Lower	
	Local Control	On	On	
	NRPN	On	On	
	Program Change	On	On	
	Drawbar Registration	On	On	
	External Zone	On	On	
Transmit Channel	Tx. Upper	Off	Off	
	Tx. Lower	Off	Off	
	Tx. Pedal	Off	Off	
	Tx. Multi	Off	Off	
	Rx. Upper	1	1(disregarded)	
	Rx. Lower	2	2(disregarded)	
	Rx. Pedal	3	3(disregarded)	
	Rx. Multi	Off	Off	
Comments	This template is used for control the MIDI equipment via External Zones playing with stand-alone or with pedalboard.		This template is used for control the MIDI equipment via External Zones playing with Lower keyboard and Pedalboard into the MIDI IN jack.	

FACTORY PATCHES

Category	#	Name
Jazz	F00	Jimmy 1
	F01	Jimmy 2
	F02	Jimmy 3
	F03	Burner
	F04	Groove
	F05	Smooth Bass
	F06	Shirley
	F07	Jimmy MC
	F08	Fat Bass
	F09	All Nine
Gospel	F10	Gospel 1
	F11	Gospel 2
	F12	Gospel 3
	F13	Gospel 4
	F14	Praise 1
	F15	Praise 2
	F16	Praise 3
	F17	Praise 4
	F18	Meditaion
	F19	Full Gospel
Rock	F20	Purple
	F21	Emerson
	F22	Some Lovin
	F23	Booker
	F24	Rock 1
	F25	Rock 2
	F26	Rock 3
	F27	Full 1
	F28	Full 2
	F29	Full Overd
Theatre	F30	Theatre C#
	F31	Theatre D
	F32	Theatre D#
	F33	Theatre E
	F34	Theatre F
	F35	Theater F#
	F36	Theatre G
	F37	Theatre G#
	F38	Theatre A
	F39	Full Theatre
Tibia	F40	Tibia 8 & 4
	F41	Tibia 8 & 2
	F42	Tibia & Vox
	F43	Tibia 8, 4 & 2
	F44	Tibia 16 & 8
	F45	Tibia 16 & 4
	F46	Tibia 16, 8 & 4
	F47	Tibia 16, 8 , 4 & 2
	F48	Tibia 16, 8, 4, 2 & 1
	F49	Full Tibia

Category	#	Name
Church	F50	Gedeckt 8
	F51	Flute 8 & 4
	F52	Principal 8
	F53	Principal Chorus
	F54	Rohr Flute
	F55	Gamba Celeste
	F56	Comet
	F57	Sesquialtera
	F58	Chorus & Mixture
	F59	Sforzando
Lo & Hi	F60	Lo & Hi 1
	F61	Lo & Hi 2
	F62	Lo & Hi 3
	F63	Odd Harmonic
	F64	M3 Low Man
	F65	Perc 16 & 4
	F66	Solo 16 & 2
	F67	Cute Solo
	F68	Eddies wind
	F69	Full Hamm
Intro 1	F70	White Shade
	F71	Percuss Bass
	F72	Four Beat
	F73	Walter Summer
	F74	Short Wave
	F75	Right 2 Left
	F76	10th Avenue
	F77	Popcorn
	F78	Doubling
	F79	Banjo
Intro 2	F80	Soloist
	F81	Choke Nose
	F82	Wah Pedal
	F83	S. F. 4ever
	F84	Upward Perc.
	F85	Dim. Trill
	F86	[REV] Loop
	F87	Jimmy 1 A-100
	F88	Jimmy 1 B-3
	F89	Jimmy 1 C-3
B-3	F90	Cancel
	F91	Stopped Fl
	F92	Dulciana
	F93	Fr. Horn
	F94	Salicional
	F95	Flutes 8 & 4
	F96	Oboe Horn
	F97	Diapason
	F98	Trumpet
	F99	Full Swell

MIDI IMPLEMENTATION

◆ CHANNEL VOICE MESSAGE

Note Off

Status	2nd Byte	3rd Byte
8nH	kkH	vvH, or
9nH	kkH	00H
n=MIDI Channel Number:	0H - FH (Ch. 1 - 16)	
kk=Note Number:	00H - 7FH (0 - 127)	
vv=Velocity(disregard):	00H - 7FH (0 - 127)	

Note On

Status	2nd Byte	3rd Byte
9nH	kkH	vvH
n=MIDI Channel Number:	0H - FH (Ch. 1 - 16)	
kk=Note Number:	00H - 7FH (0 - 127)	
vv=Velocity:	00H - 7FH (0 - 127)	

Control Change

The value set by the Control Change is not reset even when Program Change messages etc. are received.

Bank Select (CC#0, 32)

Status	2nd Byte	3rd Byte
BnH	00H	mmH
BnH	20H	llH
n=MIDI Channel Number:	0H - FH (Ch. 1 - 16)	
mm,ll=Bank Number:	00H 00H = User 01H 00H = Factory 64H 00H - 6DH 00H = Bank [C] to [A]	

Until you send the Program Change, the Bank Select process is reserved.

Volume (CC#7)

Status	2nd Byte	3rd Byte
BnH	07H	vvH
n=MIDI Channel Number:	0H - FH (Ch. 1 - 16)	
vv=Volume:	00H - 7FH (0 - 127)	

Expression (CC#11)

Status	2nd Byte	3rd Byte
BnH	0BH	vvH
n=MIDI Channel Number:	0H - FH (Ch. 1 - 16)	
vv=Expression:	00H - 7FH (0 - 127)	

Spring Shock (CC#48)

Status	2nd Byte	3rd Byte
BnH	30H	vvH
n=MIDI Channel Number:	0H - FH (Ch. 1 - 16)	
vv=Velocity:	00H - 7FH (0 - 127)	

Glide (CC#49)

Status	2nd Byte	3rd Byte
BnH	31H	vvH
n=MIDI Channel Number:	0H - FH (Ch. 1 - 16)	
vv=Control Value:	00H-7FH (0-127) 0-63=Off, 64-127=On	

Damper (CC#64)

Status	2nd Byte	3rd Byte
BnH	40H	vvH
n=MIDI Channel Number:	0H - FH (Ch. 1 - 16)	
vv=Control Value:	00H-7FH (0-127) 0-63=Off, 64-127=On	

Sustain (CC#69)

Status	2nd Byte	3rd Byte
BnH	45H	vvH
n=MIDI Channel Number:	0H - FH (Ch. 1 - 16)	
vv=Control Value:	00H-7FH (0-127) 0-63=Off, 64-127=On	

ProChord Active (CC#84)

Status	2nd Byte	3rd Byte
BnH	54H	vvH
n=MIDI Channel Number:	0H - FH (Ch. 1 - 16)	
vv=Control Value:	00H-7FH (0-127) 0-63=Off, 64-127=On	

Leslie Fast (CC#92)

Status	2nd Byte	3rd Byte
BnH	5CH	vvH
n=MIDI Channel Number:	0H - FH (Ch. 1 - 16)	
vv=Control Value:	00H-7FH (0-127) 0-63=Off, 64-127=On	

This control change is only for receive.

NRPN MSB/LSB (CC#98, 99)

Status	2nd Byte	3rd Byte
BnH	63H	mmH
BnH	62H	llH
n=MIDI Channel Number:	0H - FH (Ch. 1 - 16)	
mm=upper byte of the parameter number specified by NRPN		
ll=lower byte of the parameter number specified by NRPN		

Data Entry (CC#6, 38)

Status	2nd Byte	3rd Byte
BnH	06H	mmH
BnH	26H	llH
n=MIDI Channel Number:	0H - FH (Ch. 1 - 16)	
mm,ll=the value of the parameter specified by NRPN		

Program Change

Status	2nd Byte
CnH	ppH
n=MIDI Channel Number:	0H - FH (Ch. 1 - 16)
pp=Program Number:	00H - 63H = Patch #0 to 99 64H - 6DH = Key [C] to [A] 7EH, 7FH = Adjust [A#], [B]

Example of operation

ex: select Patch F15 for Upper part

Bx 00 01 Bx 20 00 Cx 0F (x=Upper Channel)

ex: select Favorite Bank[C#], Key[F] for Upper part

Bx 00 65 Bx 20 00 Cx 69 (x=Upper Channel)

ex: select Adjust [B] for Upper part

Cx 7F (x=Upper Channel)

◆ CHANNEL MODE MESSAGE

All Sounds Off (CC#120)

Status	2nd Byte	3rd Byte
BnH	78H	00H
n=MIDI Channel Number:	0H - FH (Ch. 1 - 16)	

When this message is received, all currently-sounding notes on the corresponding channel will be turned off immediately.

Reset All Controllers (CC#121)

Status	2nd Byte	3rd Byte
BnH	79H	00H
n=MIDI Channel Number:	0H - FH (Ch. 1 - 16)	

When this message is received, the following controllers will be set to their reset values.

Expression:	127
Glide:	Off
Damper:	Off
Sustain:	Off

NRPN: unset; previously set data will not change

All Notes Off (CC#123)

Status	2nd Byte	3rd Byte
BnH	7BH	00H
n=MIDI Channel Number:	0H - FH (Ch. 1 - 16)	

When All Notes Off is received, all notes on the corresponding channel will be turned off. However if Hold 1 or Sostenuto is ON, the sound will be continued until these are turned off.

DRAWBARS DATA LIST 1

◆ CONTROL NUMBER

Upper: 50H(80)
Lower: 51H(81)
Pedal: 52H(82)

Level	Upper / Lower									Pedal	
	16'	5 1/2'	8'	4'	2 2/3'	2'	1 3/5'	1 1/3'	1'	16'	8'
0	00H(0)	09H(9)	12H(18)	1BH(27)	24H(36)	2DH(45)	36H(54)	3FH(63)	48H(72)	00H(0)	09H(9)
1	01H(1)	0AH(10)	13H(19)	1CH(28)	25H(37)	2EH(46)	37H(55)	40H(64)	49H(73)	01H(1)	0AH(10)
2	02H(2)	0BH(11)	14H(20)	1DH(29)	26H(38)	2FH(47)	38H(56)	41H(65)	4AH(74)	02H(2)	0BH(11)
3	03H(3)	0CH(12)	15H(21)	1EH(30)	27H(39)	30H(48)	39H(57)	42H(66)	4BH(75)	03H(3)	0CH(12)
4	04H(4)	0DH(13)	16H(22)	1FH(31)	28H(40)	31H(49)	3AH(58)	43H(67)	4CH(76)	04H(4)	0DH(13)
5	05H(5)	0EH(14)	17H(23)	20H(32)	29H(41)	32H(50)	3BH(59)	44H(68)	4DH(77)	05H(5)	0EH(14)
6	06H(6)	0FH(15)	18H(24)	21H(33)	2AH(42)	33H(51)	3CH(60)	45H(69)	4EH(78)	06H(6)	0FH(15)
7	07H(7)	10H(16)	19H(25)	22H(34)	2BH(43)	34H(52)	3DH(61)	46H(70)	4FH(79)	07H(7)	10H(16)
8	08H(8)	11H(17)	1AH(26)	23H(35)	2CH(44)	35H(53)	3EH(62)	47H(71)	50H(80)	08H(8)	11H(17)

ex: Set Lower 8' to level 7 via MIDI... Bx 51 19 (x=Lower Channel)

DRAWBAR DATA LIST 2

Part	Control Number								
	16'	5 1/2'	8'	4'	2 2/3'	2'	1 3/5'	1 1/3'	1'
Upper	0CH(12)	0DH(13)	0EH(14)	0FH(15)	10H(16)	11H(17)	12H(18)	13H(19)	14H(20)
Lower	15H(21)	16H(22)	17H(23)	18H(24)	19H(25)	1AH(26)	1BH(27)	1CH(28)	1DH(29)
Pedal	21H(33)	-	23H(35)	-	-	-	-	-	-

Value	Level								
	0	1	2	3	4	5	6	7	8
	00 - 0FH (0 - 15)	10 - 1FH (16 - 31)	20 - 2FH (32 - 47)	30 - 3FH (48 - 63)	40 - 4FH (64 - 79)	50 - 5FH (80 - 95)	60 - 6FH (96 - 111)	70 - 7EH (112-126)	7FH (127)

ex: Set Lower 8' to level 7 via MIDI... Bx 17 70 (x=Upper Channel)

SYSTEM EXCLUSIVE MESSAGE

◆ MEMORY DUMP

1. Each Packet

F0	System Exclusive
55	SUZUKI ID
dd	Device ID (refer to P. 129 #19)
10	Model ID MSB
22	Model ID LSB
11	Command: Data Packet
[TYPE]	Data Type 02H = All Data Dump 07H = Combi. Temp. Dump
[PNH]	Packet Number MSB
[PNL]	Packet Number LSB
[DATA]	64 Bytes Data 128 Bytes nibblized ASCII ex: 7EH = 37H, 45H
[CHD]	Check Digit Lower 7 bits of XOR [DATA]
F7	End Of Exclusive

2. Acknowledge

F0	System Exclusive
55	SUZUKI ID
dd	Device ID
10	Model ID MSB
22	Model ID LSB
14	Command: Acknowledge
[TYPE]	Data Type
[AK]	Result 00H = OK 05H = Check Digit Error 06H = Receive Protected
[PNH]	Packet Number MSB
[PNL]	Packet Number LSB
F7	End Of Exclusive

3. # of Packets

All Data Dump: 4373
Temporary Dump: 21

◆ DUMP REQUEST

F0	System Exclusive
55	SUZUKI ID
dd	Device ID
10	Model ID MSB
22	Model ID LSB
12	Command: Dump Request
[TYPE]	Data Type 02H = All Data Dump 07H = Combi. Temp. Dump
F7	End Of Exclusive

◆ MODE SET

Full Parameters Reset (Rx. only)

F0	System Exclusive
55	SUZUKI ID
dd	Device ID
42	Mode ID for DT1
12	Command: DT1
40	Address MSB
00	Address
7F	Address LSB
7F	Reset
42	Check Sum
F7	End Of Exclusive

When this device receives this message, resets all the controllers and all notes off.

◆ NRPN SWITCH

F0	Suzuki Exclusive
55	SUZUKI ID
dd	Device ID
10	Model ID MSB
22	Model ID LSB
02	Command: NRPN Sw.
[DATA]	00H = Off, 7FH = On
F7	End Of Exclusive

When this device receives this message, switches Tx & Rx NRPN in Control channel.

◆ DATA SET (RX. ONLY)

F0	System Exclusive
55	SUZUKI ID
dd	Device ID
10	Model ID MSB
22	Model ID LSB
13	Command: Data Set
aa	Address MSB
bb	Address
cc	Address LSB
[DATA]	Data (Flexible bytes)
F7	End Of Exclusive

◆ IDENTITY REQUEST (RX. ONLY)

F0	System Exclusive
7E	Universal non real-time
dd	Device ID
06	Sub ID #1
01	Sub ID #2
F7	End Of Exclusive

◆ IDENTITY REPLY (TX. ONLY)

F0	System Exclusive
7E	Universal non real-time
dd	Device ID
06	Sub ID #1
02	Sub ID #2
55	SUZUKI ID
00 10	Device Family code
00 22	Device Family number
00 00	
00 00	
F7	End Of Exclusive

When Identity Request is received, Identity Reply will be transmitted.

GLOBAL PARAMETERS

Category	Parameter	NRPN		SysEx Address			SysEx Length	Data	Default	Description
		LSB (62)	MSB (63)	MSB to LSB						
Tune	Transpose	01	00	00	01	00	01	3A - 40 - 46 (-6 - 0 - 6)	40	0
	Master Tune	01	02	00	01	02	02	032E - 0338 - 0342 (430 - 440 - 450 Hz)	0338	A= 440 Hz
Expression	Source	02	00	00	02	00	01	00 - 02 (Pedal, MIDI, Both)	00	Pedal
	Min. Level	02	08	00	02	08	01	00 - 29 (Off, -40dB - -0dB)	06	-35dB
	Min. Limit LF	02	09	00	02	09	01	00 - 29	15	-20dB
	Min. Limit HF	02	0A	00	02	0A	01	(Off, -40dB - -0dB)	0B	-30dB
Foot Switch	Foot Controller 1 Mode	03	00	00	03	00	01	00 - 27 00: Off 01: Expression 02: Leslie Fast (alternate) 03: Leslie Fast (momentarily) 04: Leslie Fast (tri-state) 05: Glide 06, 07: Patch Fwd., Back 08, 09: Favorite Fwd., Back 0A: Spring Shock 0B: Delay Time 0C: Damper 0D: Sustain 0E: Manual Bass 0F - 27: Bass 1C - 3C 28: Prochord Closed 29: Prochord Open	01	Expression
	Foot Controller 2 Mode	03	01	00	03	01	01	Same as above	02	Leslie Fast (alternate)
	Foot Switch EXP-100 Mode	03	02	00	03	02	01	-1 than above	01	Leslie Fast (alternate)
	Damper Upper	03	03	00	03	03	01	00, 01 (Off/On)	01	On
	Damper Lower	03	04	00	03	04	01	00, 01 (Off/On)	01	On
	Damper Pedal	03	05	00	03	05	01	00, 01 (Off/On)	01	On
Panel Switch	Octave Down Mode	03	0C	00	03	0C	01	00 - 07 00: Origin 01: Leslie Stop 02: Leslie Fast 03: Vibrato Upper 04: Vibrato Lower 05: Glide 06: Spring Shock 07: Delay Time	00	Origin
	Octave Up Mode	03	0D	00	03	0D	01	Same as above	00	Origin
	Octave Lower Mode	03	0E	00	03	0E	01	Same as above	00	Origin
Patch Load	Drawbar Regist.	6b	00	00	6b	00	01	00, 01 (Off/On)	01	On
	Internal Zone (INT)	6b	01	00	6b	01	01	00, 01 (Off/On)	01	On except b=9
	External Zone (EXT)	6b	02	00	6b	02	01	00, 01 (Off/On)	01	On except b=9
	Organ Effect (DRAWB)	6b	03	00	6b	02	01	00, 01 (Off/On)	01	On except b=9
	Animation (ANI)	6b	04	00	6b	04	01	00, 01 (Off/On)	01	On except b=9
	Drawbar Parameters (DRAWB)	6b	05	00	6b	05	01	00, 01 (Off/On)	01	On except b=9
	Reverb (REV)	6b	06	00	6b	06	01	00, 01 (Off/On)	01	On except b=9
	Link Pedal to Lower	6b	07	00	6b	07	01	00, 01 (Off/On)	01	On except b=9
	Percussion (PERC)	6b	08	00	6b	08	01	00, 01 (Off/On)	01	On except b=9
	"b" means Preset Bank.									
Favorites	Use Favorites	04	00	00	04	00	01	00, 01 (Off/On)	00	Off
	Preset Key Hold Time	04	01	00	04	01	01	00 - 10 (0.0 - 1.0 sec)	00	0 sec
Display	Short Cut	--	--	--	--	--	--	0, 1, 2 sec, No	01	1 sec
	Time Out	--	--	--	--	--	--	4, 8, 16 sec, No	04	No
	Pop Up	--	--	--	--	--	--	No, 0.5, 1, 2 sec	02	1 sec
	Patch Recall	--	--	--	--	--	--	Instant, Entered	00	Instant
Master EQ	Bass Freq.	03	06	00	03	06	01	00 - 18 (20 - 308 Hz)	07	104Hz
	Treble Freq.	03	07	00	03	07	01	00 - 13 (3.0 - 8.0 kHz)	04	4.0kHz
	Bass Gain	03	08	00	03	08	01	00 - 09 - 12 (-9 - +0 - +9 dB)	09	0
	Mid Gain	03	09	00	03	09	01	00 - 09 - 12 (-9 - +0 - +9 dB)	09	0
	Treble Gain	03	0A	00	03	0A	01	00 - 09 - 12 (-9 - +0 - +9 dB)	09	0
Mid Freq.	03	0B	00	03	0B	01	00 - 0F (250 Hz - 3.1 kHz)	07	1.5 kHz	

Example Set Transpose at 0 via NRPN Bx 62 01 63 00 06 40 (x = Upper channel)
 Set Transpose at 0 via System Exclusive F0 55 dd 10 22 13 00 01 00 40 F7 (dd = Device ID)

PATCH PARAMETERS

Category	Parameter	NRPN		SysEx Address			SysEx Length	Data	Patch Load
		LSB (62)	MSB (63)	MSB to LSB					
Upper Name	10 Characters	--	--	01	00	00	0A	7 bit ASCII	always
Lower Name	10 Characters	--	--	01	00	01	0A	7 bit ASCII	always
Internal Zone	Split	05	00	00	05	00	01	00, 01 (Off/On)	INT
	Split Point	05	01	00	05	01	01	24 - 60 (MIDI note number)	
	Key Octave Upper	05	02	00	05	02	01	3E - 40 - 42 (-2 - ±0 - +2)	
	Glide Length	05	03	00	05	03	01	28 - 40 - 4C (-24 - ±0 - +12 semitones)	
	Glide Time	05	04	00	05	04	01	00 - 31 (0.1 - 5.0 seconds)	
	Glide Amp	05	05	00	05	05	01	00, 01 (Off/On)	
	Pedal To Lower	0B	00	00	06	00	01	00, 01 (Off/On)	
	PtoL Mode	0B	01	00	06	01	01	00 - 02 (Lower, Chord, Poly)	
	PtoL Range Hi	0B	02	00	06	02	01	24 - 60 (MIDI note number)	
	Key Octave Lower Split	0B	03	00	06	03	01	3E - 40 - 42 (-2 - ±0 - +2)	
	Key Octave Lower Real	0B	04	00	06	04	01	3E - 40 - 42 (-2 - ±0 - +2)	
External Zone	MIDI Channel	4n	00	00	4n	00	01	00 - 0F (1 - 16)	EXT
	Switch	4n	01	00	4n	01	01	00, 01 (Off/On)	
	Key Range Lo	4n	02	00	4n	02	01	24 - 60 (MIDI note number)	
	Key Range Hi	4n	03	00	4n	03	01	24 - 60, 61 (MIDI note number, Off)	
	Bank Select MSB	4n	04	00	4n	04	01	00 - 7F	
	Bank Select LSB	4n	05	00	4n	05	01	00 - 7F	
	Program Change	4n	06	00	4n	06	01	00 - 7F (1 - 128)	
	Octave Shift	4n	07	00	4n	07	01	3E - 40 - 42 (-2 - ±0 - +2)	
	Volume	4n	08	00	4n	08	01	00 - 7F (0 - 127)	
	Pan	4n	09	00	4n	09	01	00 - 40 - 80 (L64 - C - R63)	
	Velocity	4n	0A	00	4n	0A	01	00 - 04 (Off, Normal - Easy)	
	Expression Minimum	4n	0B	00	4n	0B	01	00 - 3F (0 - 63)	
	Expression Maximum	4n	0C	00	4n	0C	01	40 - 7F (64 - 127)	
	Expression CC#	4n	0D	00	4n	0D	01	00 - 02 (Off, 7, 11)	
	Tx. Damper On	4n	0E	00	4n	0E	01	00 - 03 (Off, CTRL1, CTRL2, EXP)	

Example "n" means Zone number. 1=0, 2=1, 3=2
 Turn Split On via NRPN.....Bx 62 07 63 05 06 01 (x = Upper channel)
 Turn Split On via System Exclusive.....F0 55 dd 10 22 13 00 07 05 01 F7 (dd = Device ID)

Category	Parameter	NRPN		SysEx Address			SysEx Length	Data	Patch Load
		LSB (62)	MSB (63)	MSB to LSB					
Percussion	Percussion On	08	00	00	08	00	01	00, 01 (Off/On)	PERC
	Third On	08	01	00	08	01	01	00, 01 (Off/On)	
	Decay Fast	08	02	00	08	02	01	00, 01 (Off/On)	
	Volume Soft	08	03	00	08	03	01	00, 01 (Off/On)	
	Level On Soft	08	04	00	08	04	01	00 - 3F (-22 - +10.5 dB)	
	Level On Normal	08	05	00	08	05	01	00 - 3F (-22 - +10.5 dB)	
	Decay Rate Fast	08	06	00	08	06	01	00 - 17, 18 (1 - 24, Cont)	
	Decay Rate Slow	08	07	00	08	07	01	00 - 17, 18 (1 - 24, Cont)	
	Touch	08	08	00	08	08	01	00, 01 (Off/On)	
	Drawbar 1' Cancel	08	0B	00	08	0B	01	00, 01 (Off/On)	
Drawbar Level	08	0C	00	08	0C	01	00, 01 (0, -3dB)		
Lower & Upper Organ section	Organ Type	20	04	00	20	04	01	00 - 05 00: A-100 01: B-3 02: C-3 03: Mellow 04: Vx 05: Farf 06: Pipe	DRAWB
	Envelope	20	05	00	20	05	01	00, 01 - 10, 11 - 20 00: Contact 01 - 10: R1 - R15 11 - 20: AR1 - AR15	
	Contact Time Offset	20	06	00	20	06	01	00 - 40 - 7F (-64 - 0 - +63)	
	Contact Damping	20	07	00	20	07	01	00 - 1F (0 - 31)	
	Fold Back Lo	20	08	00	20	08	01	00 - 0C (C1 - C2)	
	Fold Back Hi	20	09	00	20	09	01	2B - 30 (G4 - C5)	
	Leakage Level	20	0A	00	20	0A	01	00 - 7F (0 - 127)	
	Custom Pipe	20	0B	00	20	0B	01	00 - 04 (U1 - 3, F1 - 3)	
	Custom Contact	20	0C	00	20	0C	01	00 - 04 (U1 - 3, F1 - 3)	
	Custom TW A-100	20	0D	00	20	0D	01	00 - 04 (U1 - 3, F1 - 3)	
	Custom TW B-3	20	0E	00	20	0E	01	00 - 04 (U1 - 3, F1 - 3)	
	Custom TW C-3	20	0F	00	20	0F	01	00 - 04 (U1 - 3, F1 - 3)	
	Custom TW Mellow	20	10	00	20	10	01	00 - 04 (U1 - 3, F1 - 3)	
	Octave Shift Upper	20	00	00	20	00	01	3E - 40 - 42 (-2 - 0 - +2)	
	Key Range Lo Upper	20	01	00	20	01	01	24 - 60 (MIDI note number)	
	Key Range Hi Upper	20	02	00	20	02	01	24 - 60 (MIDI note number)	
	Sustain Length Upper	20	03	00	20	03	01	00 - 04 (1 - 5)	
	Octave Shift Lower	21	00	00	21	00	01	3E - 40 - 42 (-2 - 0 - +2)	
Key Range Lo Lower	21	01	00	21	01	01	24 - 60 (MIDI note number)		
Key Range Hi Lower	21	02	00	21	02	01	24 - 60 (MIDI note number)		
Sustain Length Lower	21	03	00	21	03	01	00 - 04 (1 - 5)		
Upper Registration	16'	--	--	01	01	00	01	00 - 08 (0 - 8)	UPPER
	5 1/3'	--	--	01	01	01	01	00 - 08 (0 - 8)	
	8'	--	--	01	01	02	01	00 - 08 (0 - 8)	
	4'	--	--	01	01	03	01	00 - 08 (0 - 8)	
	2 2/3'	--	--	01	01	04	01	00 - 08 (0 - 8)	
	2'	--	--	01	01	05	01	00 - 08 (0 - 8)	
	1 3/5'	--	--	01	01	06	01	00 - 08 (0 - 8)	
	1 1/3'	--	--	01	01	07	01	00 - 08 (0 - 8)	
1'	--	--	01	01	08	01	00 - 08 (0 - 8)		
Lower Registration	16	--	--	01	02	00	01	00 - 08 (0 - 8)	L/P
	5 1/3'	--	--	01	02	01	01	00 - 08 (0 - 8)	
	8'	--	--	01	02	02	01	00 - 08 (0 - 8)	
	4'	--	--	01	02	03	01	00 - 08 (0 - 8)	
	2 2/3'	--	--	01	02	04	01	00 - 08 (0 - 8)	
	2'	--	--	01	02	05	01	00 - 08 (0 - 8)	
	1 3/5'	--	--	01	02	06	01	00 - 08 (0 - 8)	
	1 1/3'	--	--	01	02	07	01	00 - 08 (0 - 8)	
1'	--	--	01	02	08	01	00 - 08 (0 - 8)		

156 MIDI INFORMATION - continued

Category	Parameter	NRPN		SysEx Address			SysEx Length	Data	Patch Load
		LSB (62)	MSB (63)	MSB	to	LSB			
Pedal	Organ Type	22	03	00	22	03	01	00 - 01 00: Normal 01: Muted	DRAWB
	Envelope	22	04	00	22	04	01	00, 01 - 10, 11 - 20 00: Contact 01 - 10: R1 - R15 11 - 20: AR1 - AR15	
	Sustain On	22	06	00	22	06	01	00, 01 (Off/On)	
	Sustain Length	22	07	00	22	07	01	00 - 04 (1 - 5)	
	Decay Length	22	08	00	22	08	01	00 - 05 (1 - 5, Cont)	
	Velocity	22	09	00	22	09	01	00 - 04 (Off, Normal - Easy)	
	Key Mode	22	0A	00	22	0A	01	00, 01 (Mono/Poly)	
	Octave Shift	22	00	00	22	00	01	3E - 40 - 42 (-2 - 0 - +2)	
	Key Range Lo	22	01	00	22	01	01	24 - 60 (MIDI note number)	
Key Range Hi	22	02	00	22	02	01	24 - 60 (MIDI note number)		
Custom Sub DB	22	0B	00	22	0B	01	00 - 04 (U1 - 3, F1 - 3)		
Pedal Registration	16'	--	--	01	03	00	01	00 - 08 (0 - 8)	L/P
	8'	--	--	01	03	01	01	00 - 08 (0 - 8)	
Organ Effects	Leslie Bypass	09	00	00	09	00	01	00, 01 (Enable / Bypass)	ANI
	Leslie Fast	09	01	00	09	01	01	00, 01 (Slow or Stop / Fast)	
	Leslie Stop	09	06	00	09	06	01	00, 01 (Slow / Stop)	
	Leslie Cabinet Number	09	02	00	09	02	01	00 - 0F (U1 - U8, F1 - F8)	
	Vibrato On Upper	09	03	00	09	03	01	00, 01 (Off/On)	
	Vibrato On Lower	21	04	00	21	04	01	00, 01 (Off/On)	
	Vibrato On Pedal	09	04	00	09	04	01	00, 01 (Off/On)	
	Vibrato Mode	09	05	00	09	05	01	00 - 05 (V1 - C3)	
	Vibrato Type	09	07	00	09	07	01	00 - 02 (55-57, 57-59, 59+)	
Vibrato Rate	09	08	00	09	08	01	00 - 7F (5.78 - 7.90 Hz)		
Vibrato Mix	09	09	00	09	09	01	00 - 40 - 7F (D64 - Even - 63V)		
Reverb	Reverb On	0A	00	00	0A	00	01	00, 01 (Off/On)	REV
	Reverb Type	0A	01	00	0A	01	01	00 - 0A 00: Room 1 01: Room 2 02: Live 03: Hall 1 04: Hall 2 05: Church 06: Plate 07: Spring 08: Delay 09: Panning Delay 0A: Reverb + Delay	
	Reverb Level	0A	02	00	0A	02	01	00 - 7F (0 - 127)	
	Reverb Time	0A	03	00	0A	03	01	00 - 7F (0 - 127)	
	Reverb Delay Feedback	0A	04	00	0A	04	01	00 - 1F (0 - 96%)	
	Reverb Delay Time	0A	05	00	0A	05	01	00 - 44 (4.7 - 2000ms)	
	Leslie On Reverb	0A	06	00	0A	06	01	00, 01 (Off/On)	

Category	Parameter	NRPN		SysEx Address			SysEx Length	Data	Patch Load
		LSB (62)	MSB (63)	MSB	to	LSB			
Effects	Overdrive On	30	00	00	30	00	01	00, 01 (Off/On)	EFFECT
	Overdrive Type	30	01	00	30	01	01	00 - 03 00: Tube 01: Stomp Box 02: Clip 03: E. Pf. Amp	
	Overdrive Drive Level	30	02	00	30	02	01	00 - 7F	
	Overdrive Controlled Exp.	30	03	00	30	03	01	00-03 00: EX-OD 01: OD-EX 02: OD Only 03: Input	
	Multi Effect On	30	04	00	30	04	01	00, 01 (Off/On)	
	Multi Effect Type	30	05	00	30	05	01	00 - 07 00: Tremolo 01: Auto Pan 02: Wah-Wah 03: Ring Mod. 04: Phaser 05: Flanger 06: Chorus 07: Delay	
	Multi Effect Parameter 0	30	06	00	30	06	01	00-03	
	Multi Effect Parameter 1	30	07	00	30	07	01	00-03	
	Multi Effect Parameter 2	30	08	00	30	08	01	00-7F	
	Multi Effect Parameter 3	30	09	00	30	09	01	00-7F	
	Multi Effect Parameter 4	30	0A	00	30	0A	01	00-7F	
	Multi Effect Parameter 5	30	0B	00	30	0B	01	00-7F	
	Multi Effect Parameter 6	30	0C	00	30	0C	01	00-7F	
	Multi Effect Parameter 7	30	0D	00	30	0D	01	00-7F	
	EQ Bass Gain	30	0E	00	30	0E	01	00 - 09 - 12 (-9 - ±0 - +9)	
	EQ Mid Gain	30	0F	00	30	0F	01	00 - 09 - 12 (-9 - ±0 - +9)	
	EQ Treble Gain	30	10	00	30	10	01	00 - 09 - 12 (-9 - ±0 - +9)	
	EQ Bass Frequency	30	11	00	30	11	01	00 - 18 (20 - 308 Hz)	
	EQ Mid Frequency	30	12	00	30	12	01	00 - 0A (250 Hz - 3.1 kHz)	
	EQ Treble Frequency	30	13	00	30	13	01	00 - 13 (3.0 - 8.0 kHz)	
	EQ Tone Control	30	14	00	30	14	01	00 - 09 - 0C (-9 - ±0 - +3)	
	Patch Level	30	15	00	30	15	01	00 - 7F (0 - 127)	
	Tube Routing	30	16	00	30	16	01	00 - 04 00: X7 to U7 01: U7 to X7 02: U7 to U7 03: X7 to X7 04: Bypass	
	Tube Drive Level	30	17	00	30	17	01	00 - 7F (0 - 127)	
	Trans Drive Level	30	18	00	30	18	01	00 - 7F (0 - 127)	
	Trans Hysteresis	30	19	00	30	19	01	00 - 7F (0 - 127)	
Trans Depth Upper	30	1A	00	30	1A	01	00 - 7F (0 - 127)		
Trans Depth Percussion	30	1B	00	30	1B	01	00 - 7F (0 - 127)		
Trans Depth Lower	30	1C	00	30	1C	01	00 - 7F (0 - 127)		
Trans Depth Pedal	30	1D	00	30	1D	01	00 - 7F (0 - 127)		

Example: Set Multi-Effect at Phaser via NRPN.....Bx 63 05 62 30 06 04 26 00 (x = Upper channel)
 Set Multi-Effect at Phaser via SysEx.....F0 55 dd 10 22 13 00 30 05 04 F7 (dd = Device ID)

FAVORITES

Category	Parameter	SysEx Address			SysEx Length	Data	Default	Description
		MSB	to	LSB				
Favorites	Upper	73	0b	0k	02	00 00 - 00 63, 01 00 - 01 63 (U00 - U99, F00 - F99)	same as Key	b: Bank [C] - [A]: 0 - 9 k: Key [C] - [A]: 0 - 9
	Lower	74	0b	0k	02			

Example Set Lower E-C# at U05 via System Exclusive.....F0 55 dd 10 22 74 19 04 01 00 05 F7 (dd = Device ID)

LESLIE PARAMETERS

Category	Parameter	NRPN (XK-5)		NRPN (L21)		SysEx Address			SysEx Length	Data (XK-5)	Data (L21)
		LSB (62)	MSB (63)	LSB (62)	MSB (63)	MSB to LSB					
Cabinet	Name	--	--	--	--	03	00	00	0A	(10 Characters)	--
	Speaker	06	00	--	--	00	06	00	01	00 - 07 00: 145 Front 01: 145 Rear 02: 147 Front 03: 147 Rear 04: 122 Front 05: 122 Rear 06: Cone Type 07: PR-40	--
	Slow Speed Horn	06	01	7F	00	00	06	01	02	00 00, 00 01 - 00 65 (0, 20 - 120 rpm)	00, 01 - 31 (0, 24 - 168 rpm)
	Slow Speed Drum	06	02	7F	01	00	06	02	02	00 00, 00 01 - 00 65 (0, 20 - 120 rpm)	00, 01 - 09 (0, 24 - 48 rpm)
	Fast Speed Horn	06	03	7F	02	00	06	03	02	00 00, 00 01 - 02 2D (0, 200 - 500 rpm)	00, 01 - 1B (0, 376 - 452 rpm)
	Fast Speed Drum	06	04	7F	03	00	06	04	02	00 00, 00 01 - 02 2D (0, 200 - 500 rpm)	00, 01 - 15 (0, 372 - 431 rpm)
	Rise Time Horn	06	05	7F	04	00	06	05	01	00 - 24 (0.8 - 12.5 sec)	08 - 27 (0.8 - 12.5 sec)
	Rise Time Drum	06	06	7F	05	00	06	06	01	00 - 23 (1.0 - 12.5 sec)	01 - 22 (1.0 - 12.0 sec)
	Fall Time Horn	06	07	7F	06	00	06	07	01	00 - 24 (0.8 - 12.5 sec)	08 - 27 (0.8 - 12.5 sec)
	Fall Time Drum	06	08	7F	07	00	06	08	01	00 - 23 (1.0 - 12.5 sec)	01 - 22 (1.0 - 12.0 sec)
	Brake Time Horn	06	09	7F	08	00	06	09	01	00 - 24 (0.8 - 12.5 sec)	08 - 27 (0.8 - 12.5 sec)
	Brake Time Drum	06	0A	7F	09	00	06	0A	01	00 - 23 (1.0 - 12.5 sec)	01 - 22 (1.0 - 12.0 sec)
	Delay Time Horn	06	0B	--	--	00	06	0B	01	00 - 05 (0.0 - 1.0 sec)	--
	Delay Time Drum	06	0C	--	--	00	06	0C	01	00 - 05 (0.0 - 1.0 sec)	--
	Mic. Width Horn	06	0D	--	--	00	06	0D	01	00 - 64 (0 - 100 cm)	--
	Mic. Width Drum	06	0E	--	--	00	06	0E	01	00 - 64 (0 - 100 cm)	--
	Mic. Center Horn	06	0F	--	--	00	06	0F	01	0E - 40 - 72 (-50 - ±0 - +50 cm)	--
	Mic. Center Drum	06	10	--	--	00	06	10	01	0E - 40 - 72 (-50 - ±0 - +50 cm)	--
	Mic. Distance Horn	06	11	--	--	00	06	11	02	00 1E - 01 48 (30 - 200 cm)	--
	Mic. Distance Drum	06	12	--	--	00	06	12	02	00 1E - 01 48 (30 - 200 cm)	--
Level Horn	06	13	7F	19	00	06	13	01	00, 01 - 4D (-Inf, -76 - 0 dB)	00 - 63 (0 - 99)	
Level Drum	06	14	7F	1A	00	06	14	01	00, 01 - 4D (-Inf, -76 - 0 dB)	00 - 63 (0 - 99)	
Level Sub Bass	06	15	7F	1B	00	06	15	01	00, 01 - 4D (-Inf, -76 - 0 dB)	00 - 63 (0 - 99)	

NRPN XK-5 or L21 are switched automatically by whether the Leslie speaker is connected.

The "Time" parameter is a rough estimate at changing speed from 40 to 400 rpm.

STONE WHEEL PARAMETERS

Category	Parameter	SysEx Address			SysEx Length	Data	Description
		MSB to LSB					
Temporary Tone Wheels	Name	1s	00	00	0A	(10 characters)	s: Tone Wheel set 0 = A-100 1 = B-3 2 = C-3 3 = Mellow
	Wheel Level	1s	01	tt	02	00 00 - 01 1B (0 - 155)	tt: Tone Wheel number; 00 - 0B (#01 - #12), 0C - 17 (#F01 - F12), 18 - 66 (#13 - #91), 67 - 6B (#F92 - #F96)
	Wheel HPF	1s	02	tt	01	00 - 7F (0 - 127)	
	Leak Trim	1s	03	tt	02	00 00 - 01 1B (0 - 155)	tt: Fundamental TW #; 00 - 54 (#01 - #73)
	Matrix Level	2s	nn	0g	02	00 00 - 01 1B (0 - 155)	nn: Note number g: Footage(0 = 16', 1 = 5 1/3'... 8 = 1')
	Leak Level	3s	tt	ll	02	00 00 - 01 1B (0 - 155)	tt: Fundamental TW #; 00 - 54 (#01 - #73) ll: Leaking TW #; 48 - 66 (#61 - #91)

PIPE PARAMETERS

Category	Parameter	SysEx Address			SysEx Length	Data	Description
		MSB to LSB					
Pipes	Name	40	00	00	0A	(10 characters)	
	Volume	40	01	pp	01	00 - 7F (0 - 127)	pp: Pipe number 00 - 13 (#01 - #20)
	Detune	40	02	pp	01	0E - 40 - 72 (-50 - ±0 - +50)	
	Chiff	40	03	pp	01	00 - 03 (Off, Soft, Normal, Loud)	
	Cut Off Frequency	40	04	pp	01	00 - 40 (-64 - 0)	
	Pan - Direction	40	05	pp	01	00 - 40 - 7F (L64 - Center - R63)	
	Pan - Imaging	40	06	pp	01	00 - 04 (Fixed, L-R, R-L, Pyramid, Inverted Pyramid)	

PEDAL SUB DRAWBARS PARAMETERS

Category	Parameter	SysEx Address			SysEx Length	Data	Description
		MSB to LSB					
Temporary Pedal Sub Drawbars	Name	50	00	00	0A	(10 characters)	
	Normal 16' - 16'	50	00	01	01	00 - 08 (0 - 8)	
	Normal 16' - 5 1/3'	50	00	02	01	00 - 08 (0 - 8)	
	Normal 16' - 8'	50	00	03	01	00 - 08 (0 - 8)	
	Normal 16' - 4'	50	00	04	01	00 - 08 (0 - 8)	
	Normal 16' - 2 2/3'	50	00	05	01	00 - 08 (0 - 8)	
	Normal 16' - 2'	50	00	06	01	00 - 08 (0 - 8)	
	Normal 16' - 1 3/5'	50	00	07	01	00 - 08 (0 - 8)	
	Normal 16' - 1 1/3'	50	00	08	01	00 - 08 (0 - 8)	
	Normal 8' - 8'	50	00	09	01	00 - 08 (0 - 8)	
	Normal 8' - 4'	50	00	0A	01	00 - 08 (0 - 8)	
	Normal 8' - 2 2/3'	50	00	0B	01	00 - 08 (0 - 8)	
	Normal 8' - 2'	50	00	0C	01	00 - 08 (0 - 8)	
	Normal 8' - 1 3/5'	50	00	0D	01	00 - 08 (0 - 8)	
	Normal 8' - 1 1/3'	50	00	0E	01	00 - 08 (0 - 8)	

CONTACT PARAMETERS

Category	Parameter	SysEx Address			SysEx Length	Data	Description
		MSB to LSB					
Temporary Contacts	Name	60	00	00	0A	(10 characters)	
	Attack Rate Center	6p	1g	kk	01	00 - 7F (0 - 127)	p: Part (0 = Upper, 1 = Lower) g: Footage (0 = 16', 1 = 5 1/3'... 8 = 1', 9 = Perc) kk: MIDI note number
	Attack Rate Variation	6p	2g	kk	01	00 - 7F (0 - ±127)	
	Release Rate Center	6p	3g	kk	01	00 - 7F (0 - 127)	
	Release Rate Variation	6p	4g	kk	01	00 - 7F (0 - ±127)	
	Physical Contact Number	6p	5g	kk	01	00 - 02 (1, 2, 3)	
	Physical Contact Delay	6p	6g	kk	01	00 - 7F (0 - 127)	

SYSTEM PARAMETERS

Category	Parameter	SysEx Address			SysEx Length	Data Range	Description
		MSB	to	LSB			
MIDI	MIDI IN Lower/Other	70	00	00	01	Sequence, Lower, Upper	
	Local Control	70	00	01	01	Off/On	
	TRx. NRPN (P. 152)	--	--	--	--	Off/On	
	Tx. Leslie Param.	70	00	02	01	XK/21	
	Rx. Dump	70	00	03	01	Off/On	
	TRx. Prog. Change	70	00	04	01	Off/On	
	TRx. Drawbar Regi.	70	00	05	01	Off/On	
	Tx. Ext. Zone	70	00	06	01	Off/On	
	Tx. Ext. Zone Program	70	00	07	01	Off/On	
	Tx. Ext. Zone Control	70	00	08	01	Off/On	
	Tx. Multi Contact	70	00	09	01	Off/On	
	Tx. Channel Upper	70	00	0A	01	1 - 16, Off	
	Tx. Channel Lower	70	00	0B	01	1 - 16, Off	
	Tx. Channel Pedal	70	00	0C	01	1 - 16, Off	
	Rx. Multi Contact	70	00	0D	01	Off/On	
	Rx. Channel Upper	70	00	0E	01	1 - 16, Off	
	Rx. Channel Lower	70	00	0F	01	1 - 16, Off	
	Rx. Channel Pedal	70	00	10	01	1 - 16, Off	
Device ID	--	--	--	--	1 - 32		
Assignable Drawbars	Control Zone	72	00	0g	01	00 - 05 (Ext. U1 to P1)	g: Footage (0 = 16', 1 = 5 1/3'... 8 = 1')
	Control Change	72	01	0g	01	0 - 59 (CC#1 - 31, 65 - 95)	
Power	Auto Off	71	00	00	01	Disable, 30 min	
Ext. Leslie	Channel(s)	71	00	01	01	1, 3, 1+LINE	

UPPER A#

Bass 16'	Strings 16'	Flute 8'	Oboe 8'	Trumpet 8'	Strings 8'	Flute 4'	Piccolo 4'	Strings 4'	Farf Vx. Pipe
16'	8'	4'	2'	II	III	IV	~	^	
Bourdon 16'	OpenDiap 8'	Gedeckt 8'	VoixClst II	Octave 4'	Flauto 4'	Flute 2'	Mixture III	Hautbois 8'	

UPPER B

Bass 16'	Strings 16'	Flute 8'	Oboe 8'	Trumpet 8'	Strings 8'	Flute 4'	Piccolo 4'	Strings 4'
16'	8'	4'	2'	II	III	IV	~	^
Bourdon 16'	OpenDiap 8'	Gedeckt 8'	VoixClst II	Octave 4'	Flauto 4'	Flute 2'	Mixture III	Hautbois 8'

PEDAL

Bass 16'+8' PrncChorus Mixture

LOWER A#

Bass 16'	Strings 16'	Flute 8'	Oboe 8'	Trumpet 8'	Strings 8'	Flute 4'	Piccolo 4'	Strings 4'	Farf Vx. Pipe
16'	8'	4'	2'	II	III	IV	~	^	
Principal 16'	Principal 8'	Melodia 8'	RohrFlute II	Prestant 4'	Flute 4'	SuperOctave 2'	Mixture III	Trompette 8'	

LOWER B

Bass 16'	Strings 16'	Flute 8'	Oboe 8'	Trumpet 8'	Strings 8'	Flute 4'	Piccolo 4'	Strings 4'
16'	8'	4'	2'	II	III	IV	~	^
Principal 16'	Principal 8'	Melodia 8'	RohrFlute II	Prestant 4'	Flute 4'	SuperOctave 2'	Mixture III	Trompette 8'

This label indicates footages for the each Organ Type. Put on the top board with copied. Please use "removable" type tape when sticking on the top board.

CUSTOM TONE WHEELS

A-100, B-3, C-3

F1: Normal

Simulates the organ's Tone Wheels with precision.

F2: Rumble less

Cut off the motor rumble by using high-pass filter.

F3: Mixture

Sounds leakage tones with harmonized.

Mellow

F1: Full Flats

Like the electronic organ, oscillates at flatly.

F2: Husky

Dips the middle frequency.

F3: Flute Lead

Boosts the middle frequency.

CUSTOM CONTACT

F1: B-3 A27563

Simulates the organ as above.

F2: Regular

Physical contact 1 sounds 8', 2', 1'

Physical contact 2 sounds 5-1/3', 2-2/3', 1-1/3'

Physical contact 3 sounds 16', 4', 1-3/5'

F3: Single

All the footages sounds at deepest physical contacts.

CUSTOM SUB DRAWBARS

F1: B-3 A27563

F2: B-3 #87396

F3: A-100 #33339

All the customs simulates the organs as above.

CUSTOM CABINETS

122 Gentle

Simulates 122 cabinet (Large body, peaking horn driver) heard from a distance, rear.

122 Wild

Simulates 122 cabinet heard from closer, front.

31H-Type

Simulates 31H cabinet heard from a distance, rear.

147 Gentle

Simulates 147 cabinet (Large body, wide range) heard from a distance, rear.

147 Wild

Simulates 147 cabinet heard from closer, front.

145 Gentle

Simulates 145 cabinet (Middle body, slightly narrow range) heard from a distance, rear.

145 Wild

Simulates 145 cabinet heard from closer, front.

PR-40

Simulates a stationary speaker system.

CUSTOM PIPES

Normal

An ordinary Pipe set for widely purpose.

No Chiff

Gently Pipe set by reducing "chiff" on the beginning of sounding.

Heavy Detune

Makes beating intentionally by detuned pitch of each Pipe Stops.

MIDI IMPLEMENTATION CHART

Drawbar Keyboard
Model: XK-5

MIDI Implementation Chart

Date: 27-Nov-2014
Version: 1.0

Function		Transmitted	Recognized	Remarks
Basic Channel	Default Changed	*1 1 - 16	*1 1 - 16	*1: Upper = 1, Lower = 2, Pedal = 3
Mode	Default Messages Altered	3 X *****	3 X X	
Note Number	: True Voice	12 - 120 *****	36 - 96 36 - 96	
Velocity	Note ON Note OFF	O X	O X	
After Touch	Key's Ch's	X X	X X	
Pitch Bend		X	X	
Control Change	0, 32	O	O	Bank Select MSB, LSB
	1	X	X	Modulation
	6, 38	O	O	Data Entry MSB, LSB
	7	O	O	Volume
	10	O	X	Pan
	11	O	O	Expression
	12 - 20, 80	O	O	Drawbar Reg. Upper
	21 - 29, 81	O	O	Drawbar Reg. Lower
	33, 35, 82	O	O	Drawbar Reg. Pedal
	48	O	O	Spring Shock
	49	O	O	Glide
	64	O	O	Damper
	69	O	O	Sustain
	84	O	O	ProChord Active
	92	X	O	Leslie Fast
98, 99	O	O	NRPN MSB, LSB	
Program Change	: True #	O 0 - 127	O 0 - 99, 126, 127	Patches, Adjust A#, B
System Exclusive		O	O	
System Common	: Song Position : Song Select : Tune	X X X	X X X	
System Real Time	: Clock : Commands	X X	X X	
Aux Messages	: All Sounds Off	X	O	(120)
	: Reset All Controllers	O	O	(121)
	: Local On/Off	X	X	
	: All Notes Off	O	O	
	: Active Sense : Reset	O X	O X	

Mode 1: OMNI ON, POLY Mode 2: OMNI ON, MONO
Mode 3: OMNI OFF, POLY Mode 4: OMNI OFF, MONO

O: Yes
X: No

	External Zone (Tx. only)	Upper Part	Lower Part	Pedal Part
Note	O	O	O	O
Pitch Bend	X	X	X	X
Modulation	X	X	X	X
Volume (7)	O	O *1	X	X
Pan (10)	O	X	X	X
Expression (11)	O	O *1	X	X
Hold 1 (64)	O	O	O	O
Hold 2 (69)	X	O	O	X
Drawbar Reg.	X	CC#80, 12 - 20 (Upper) 21 - 29 (Lower) 33, 35 (Pedal)	CC#81	CC#82
Spring Shock (48)	X	O	X	X
ProChord Active (84)	X	O	X	X
Leslie Fast (92)	X	O *2	X	O *2
RPN (100, 101)	X	X	X	X
NRPN (98, 99)	X	O	X	X
All Notes Off (123)	O	O	O	O
All Sounds Off (120)	X	O *2	O *2	O *2
Reset All Ctrl. (121)	O	O	O	O
After Touch	X	X	X	X
Bank Select (0, 32)	Change the voice for each zone.	Patch	Patch, Favorite *3	X
Program Change				X

*1: It works for all parts (audio controlled)

*2: For Rx. only.

*3: Receives as Favorite number if MIDI IN mode at "LOWER".

Sound Generator

MTW I (Modelled Tone Wheel I)
 61 polyphony (for manual)
 3 polyphony (for pedal)

Keyboards

73 (61 + 12 Preset Keys)
 Square-front ("Waterfall"-style)
 Virtual Multi-Contact

Harmonic Drawbars**Drawbars**

Upper: 2 x 9 Pitches
 Lower: 2 x 9 Pitches
 Pedal: 2 Pitches

Voicing

Manuals: 4 (A-100, B-3, C-3, Mellow, Vx, Farf, Pipe)
 Pedal: 3 (Normal, Muted, Pipe)
 Virtual Multi-Contact (A-100, B-3, C-3 & Mellow only)

Touch Response Percussion**Buttons**

Percussion On, Third Harmonic, Fast Decay, Volume Soft

Adjustable

Touch, Velocity, Decay (Fast, Slow), Level (Normal, Soft)

Effects**Vibrato and Chorus**

Digital Scanner

Tube Pre-Amp

Device: 12AX7, 12AU7
 Adjustable: Routing, Level

Overdrive

Control: On, Depth

Multi Effects

8 programs

Equalizer

Bass, Mid, Treble, Tone

Internal Leslie

Advanced Digital, 2 Rotors
 Buttons: Bypass, Stop, Fast

Reverb

Digital, 11 programs
 Control: On, Depth
 Leslie On Reverb

Master Equalizer

Bass, Mid, Treble

Keymap**Buttons**

Pedal To Lower, Split, Transpose, Octave Down, Octave Up, Lower

Adjustable

Coupler Highest note, Split Point

Patches**Capacity**

100 User Patches, 100 Factory Patches, Adjust Preset A#/B

Favorites

10 Keys

Patch Load Options

Drawbar Registration, Drawbar Parameters, Internal Zone, External Zone, Effects, Reverb

Controllers**Volume**

Master Volume

Switch

Power On/Off

Storage

USB Flash Drive

Display

20 - Characters, 2 - Lines
 7 Control Buttons and Value knob

MIDI**Templates**

5 Templates

Zones

3 External Zones (Upper)
 2 External Zones (Lower)
 1 External Zone (Pedal)
 and Keyboard Channels:
 Upper, Lower, Pedal

Connections**MIDI**

In (Pedal), In (Lower/Other), Out

USB

To Host

H-Bus

To Keyboard/Pedal (0.3A max)

Audio

Line Out L/Mono, R, Headphones (Rear, Bottom)

Leslie

11 - pin, 1 and 3 channels available

Others

Leslie Switch, Foot Controller 1, 2, Exp. Pedal, AC Inlet

Dimensions

119(W), 40(D), 12(H) cm
 46.8"(W), 15.8"(D), 4.7"(H)

Weight

15.7 kg
 34.6 lbs

Index

欧字

A

Active Drawbars 81
Adjust Preset 29, 34
Assign 80
Assignable Drawbars 81
Auto Power Off 26

B

Back Up 26

C

Cabinet 86
Chorus 108. also: Vibrato & Chorus
Complex Tone Wheels 90
Contact 92
Control 78
CONTROL 71
Coupler 59
Custom Cabinet. see: Leslie
Custom Tone Wheel 89

D

Damper 80
Default 26
Delay 109
Delete 140
Display 81
Drawbar 44, 74, 80

E

Equalizer 110
Expression 79
Expression Pedal 17
External Zone 126

F

Farf 42
Favorite 29, 77
Flanger 107
Fold Back 74
Folder Structure 132
Foot Controller 78
Foot Switch 16
Format 133
Function Mode 68

G

Glide 79

H

Harmonic Drawbars. see: Drawbar
H-BUS 125

I

Internal Zone 126

K

Key Click 74
Key Mode 75

L

Leakage Tone 75, 90
Leslie 55, 86
Leslie Channel 18
Leslie Mode Switch 32
Leslie Speaker 18
L/MONO 13
Load 138
Lock 72

M

Master Equalizer 33
Match 51
Menu Mode 66
MIDI 116
MIDI Pedalboard 21
MIDI Synthesizer 122
MIDI Template 148
Multi Effects 56, 101

O

Octave 58, 74
Organ Type 42

P

Panic 127
Part 35
Patch 27, 60, 76
Patch Level 76
Patch Load 76
Patch Recall 76
Pedal 85
Pedal Registration 96
Pedal Sustain 59
Pedal To Lower 59
Percussion 52, 84
Phaser 106
Pipe 42, 98
Play Mode 65
Polarity 13
Pre-Amplifier 101
Preset Key 28, 45, 77

R

Resonance 104, 106, 107, 108
Reverb 56, 111
Ring Mod. 105
Rotary Speaker 19

S

Save 136
Setup 132
Short Cut 71
Sounding Point 122
Split 58
Stationary Speaker 19
Sub Drawbar 96
Sustain 75, 80
System 113

T

Tone Wheels 42
Transistor 42
Transpose 57
Tremolo 103
Tune 83

U

Update 142
USB 116
USB Mass Storage 135

V

Velocity 75
Vibrato & Chorus 53, 85
Vx 42

W

Wah-Wah 104

Hammond maintains a policy of continuously improving and upgrading its instruments and therefore reserves the right to change specifications without notice. Although every attempt has been made to insure the accuracy of the descriptive contents of this Manual, total accuracy cannot be guaranteed.

Should the owner require further assistance, inquiries should first be made to your Authorized Hammond Dealer.

If you still need further assistance, contact Hammond at the following addresses:

In the United States Contact:

HAMMOND SUZUKI USA, Inc.

743 Annoreno Drive, Addison, Illinois
60101

UNITED STATES

Tel: (630) 543-0277

Fax: (630) 543-0279

Web site: www.hammondorganco.com

E-mail: info@hammondorganco.com

Product Registration

[http://hammondorganco.com/support/
online-product-registration/](http://hammondorganco.com/support/online-product-registration/)



In European countries contact:

HAMMOND SUZUKI EUROPE B. V.

IR. D. S. Tuynmanweg 4a 4131 PN Vianen

THE NETHERLANDS

Tel: (+31) 347-370 594

Web site: www.hammond.eu

E-mail: info@hammond.eu

Product Registration

[http://www.hammond.eu/support/
online-product-registration/](http://www.hammond.eu/support/online-product-registration/)



Please contact Suzuki Corporation
for other countries.

HAMMOND SUZUKI Ltd.

2-25-11, Ryoke, Naka-ku, Hamamatsu,
Shizuoka Pref. 430-0852

JAPAN

Tel: (+81) 53-460-3781

Fax: (+81) 53-460-3783

E-mail: suzukicorp@suzuki-music.co.jp

Technical materials are available and can be obtained by mailing a request to the appropriate address listed above marked ATTENTION: SERVICE DEPARTMENT.

Manufacturer:

SUZUKI MUSICAL INSTRUMENT MFG. Co., Ltd.

2-25-12, Ryoke, Naka-ku, Hamamatsu, Shizuoka Pref. 430-0852

JAPAN

