



STAGEDRIVE+

QUICKSTART GUIDE

ENGLISH (1 - 26)

GUÍA DE INICIO RÁPIDO

ESPAÑOL (27 - 52)

GUIDE D'UTILISATION SIMPLIFIÉ

FRANÇAIS (53 – 77)

GUIDA RAPIDA

ITALIANO (78 - 103)

KURZANLEITUNG

DEUTSCH (104 – 128)

SNELSTARTGIDS

NEDERLANDS (129 – 153)

QUICKSTART GUIDE (ENGLISH)

BOX CONTENTS

STAGEDRIVE+
 Power cable
 Software CD
 Quickstart Guide
 Safety & Warranty Information Booklet

QUICK SETUP

1. Make sure all items listed in the BOX CONTENTS section are included in the box.
2. **READ SAFETY & WARRANTY INFORMATION BOOKLET BEFORE USING THE PRODUCT.**
3. Study the connection diagram in this guide.
4. Place all devices in an appropriate position for operation.
5. Make sure all devices are turned off and all faders and gain knobs are set to "zero."
6. Connect all sound sources' outputs to amplifier inputs as indicated in the diagram.
7. Connect the amplifier outputs to speakers.
8. Plug all devices into an appropriate power source.
9. Switch everything on in the following order:
 - Sound sources (i.e. microphones, turntables, CD players, etc.)
 - Mixer
 - Amplifier
 - Speakers
10. When turning powering down, turn everything off in the following order:
 - Speakers
 - Amplifier
 - Mixer
 - Sound sources

FRONT PANEL DIAGRAM

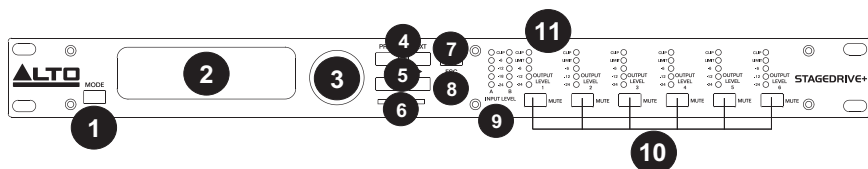

1. **MODE BUTTON-** Selecting one of four modes: PRESET, DELAY, EDIT and UTILITY.
2. **DISPLAY-** Shows the pages of the various menus and their parameters.
3. **DIAL KNOB-** Edits the value of the selected parameter.
4. **PREV/NEXT BUTTON-** Accesses menu pages and/or parameters.
5. **NAVIGATION CURSOR KEYS-** Selects various parameters.
6. **MEMORY CARD SLOT-** MMC card slot to store PRESETS.
7. **ENTER KEY-** Confirms editing of parameters.
8. **ESC KEY-** Exits the selected editing page or cancels an editing operation.
9. **INPUT LEVEL LEDS-** Shows the level of input A/B.
10. **MUTE SWITCHES-** Mutes the signal from any of the six respective outputs.
11. **OUTPUT LEVEL LEDS-** Shows the output level.

Note: The LIMITER will change the way in which the output level is displayed on the corresponding LED. The level shown on the meter is no longer the "absolute" output level, but the level of the signal at -24dB, -12dB, -6dB compared to the limiter threshold (indicated by the orange LIMIT LED).

REAR PANEL DIAGRAM

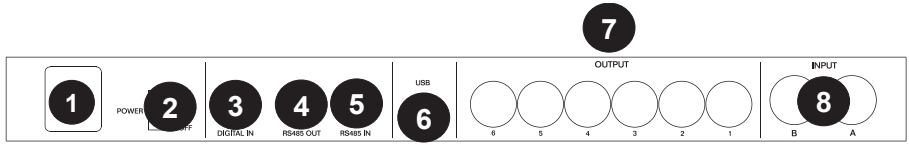

- AC INPUT AND FUSE HOLDER**- Connect the included power cable here.
CAUTION: If the fuse needs to be replaced, please refer to a qualified technician. If the fuse continues to blow after replacing, discontinue use of this unit and seek repair.
- POWER SWITCH**- Turns the main POWER on and off.
- DIGITAL IN**- Connect a balanced XLR-F cable here.
- RS485 OUT**- Allows outgoing communication between a STAGEDRIVE+ and other STAGEDRIVE+ units.
- RS485 IN**- Allows incoming communication between a STAGEDRIVE+ and other STAGEDRIVE+ units.
- USB PORT**- Allows communication via PC.
- OUTPUTS**- Use Balanced XLR-M cables on these outputs.
- INPUTS**- Balanced XLR - ¼" combo jacks.

GETTING STARTED

Adjusting the input signal

- Keep the STAGEDRIVE+ outputs in **MUTE** status (LEDs on) by pressing each respective Mute button on the front panel.
- Feed a signal into the STAGEDRIVE+ input and watch the **INPUT LEVEL A-B** LED meter.
- Keep the signal high, but without triggering the **CLIP** LED continually, adjusting the input gain if necessary.
- Press the **MODE** key until the **EDIT** menu LED lights up. Use the **PREV** and **NEXT** keys to go to the **Input Gain** page and then press **ENTER**.
- Use the **DIAL** to change the gain value and watch the level of the signal on the LED meter until ideal values are reached.
- Use the **PREV** and **NEXT** keys to access to the **INB Gain** page.

MENUS

PRESET Menu

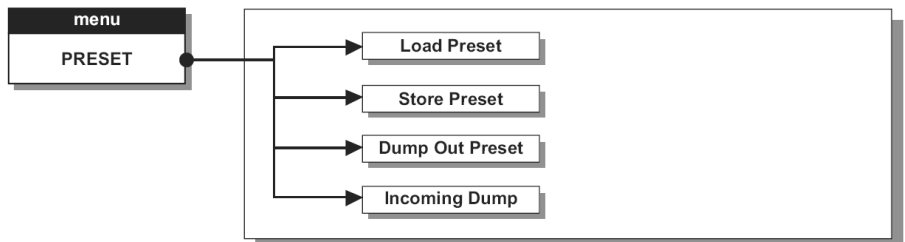

Types of PRESETS

There are 3 categories of PRESETS:

- F** = Factory PRESETS which cannot be permanently changed. These are the starting points for creating User PRESETS and card PRESETS from scratch.
- U** = User PRESETS can be programmed by users.
- C** = Card PRESETS can be programmed by users and stored on a Multimedia Memory Card.

To Load a PRESET:

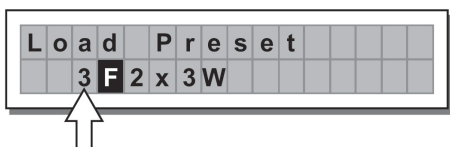

- Use the DIAL to select a Factory PRESET (indicated by the letter F) and press ENTER to load the preset into memory.

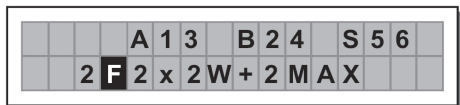

Adjusting the input gain



1. Keep the STAGEDRIVE+ outputs in MUTE status (LEDs light on).
2. Feed a signal in on the STAGEDRIVE+'s input and watch the LED meter.
3. To obtain a good signal level, make certain the red INPUT LEVEL A-B CLIP LED does not light up continually.
4. Find out the output level setting for your mixer (or other unit) and connect it to the input of the STAGEDRIVE+.
5. Adjust the STAGEDRIVE+ input gain by pressing the MODE key until the EDIT menu LED lights up.
6. Use the PREV and NEXT keys to go to the Input Gain page:
7. Press ENTER. The display will show the IN A Gain or IN A&B Gain page (according to the configuration and other utilities loaded in the memory):
8. Use the DIAL to change the gain value and watch the level of the signal on the LED meter until ideal values are reached. Then use the PREV and NEXT keys to access the IN B Gain page (if there is one, which will depend on the configuration and the other utilities loaded in the memory).

To save a PRESET:

1. Use the DIAL to select an area in which the PRESET is to be saved and press ENTER.
2. Use the ◀ and ▶ keys to position the cursor on a character and use the DIAL to enter the alphanumeric value.
3. Edit the PRESET name if desired and press ENTER to save the changes or press ESC to abort.

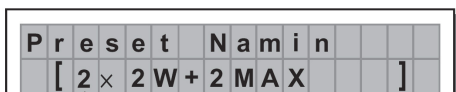

COMM. SETUP SUBMENU- This submenu allows access to the setting of communication with other units via the USB port. **Note:** The 'Dump Out Preset' and 'Incoming Dump' functions are an exception, as they're controlled directly in the PRESET menu.

Transmit PRESETS- Use this menu page to transmit PRESETS via the RS485 ports to copy PRESETS to another STAGEDRIVE+.

To download a PRESET- Select a PRESET using the DIAL and press ENTER.

Note: The menu page remains unchanged to allow other PRESETS to be dumped.

All the Presets data (name, configuration, parameter values, etc.) are immediately transmitted to the units connected to the RS485 port.

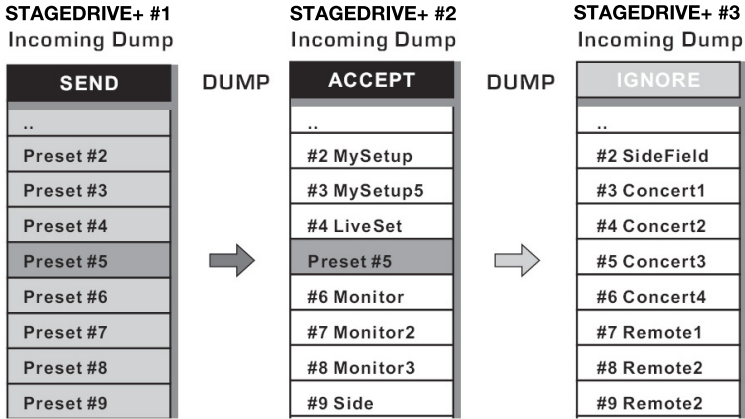

Note: In order for the transfer to work, the receiving units must be able to identify and accept Incoming Dump operations. When two or more STAGEDRIVE+ are connected, the PRESET sent by the transmitting STAGEDRIVE+ overwrites the existing PRESET in the same memory position of the receiving STAGEDRIVE+.

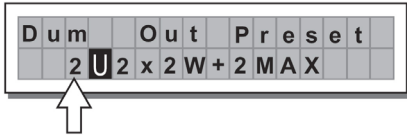

Incoming Dump

Accepts or ignores the Dump of a PRESET sent from another STAGEDRIVE+ via the RS485 port or from a computer via USB. Ports settings can be:

- Ignore the data that is being sent
- Accept the data that is being sent

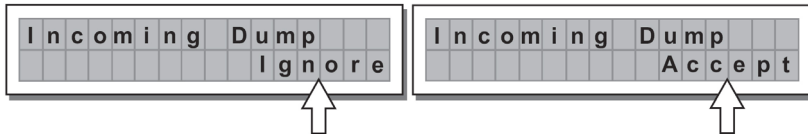

System Protection

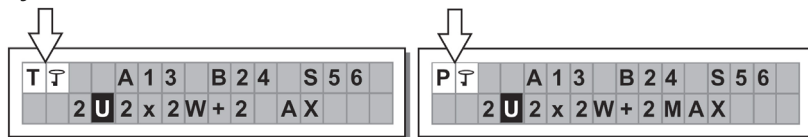

These indications appear when the **LOCK** function is enabled, (when the LOCK UTILITY system is totally (T) or partially (P) protected against accidental or unauthorized changes). Protection is set by using a password, without which editing cannot be achieved.

DELAY MENU

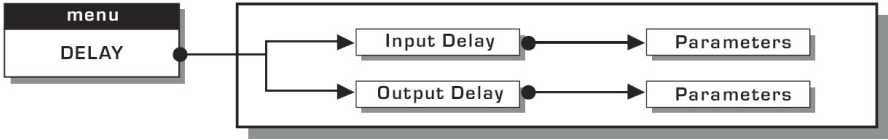

Input Delay: Delays the signal of an input (or the sum of the inputs) before sending it to the routing system. All outputs will be delayed by the same length of time. This is commonly used to compensate for distances between speaker enclosures or large venues.

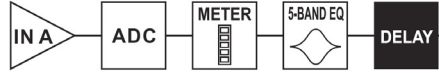
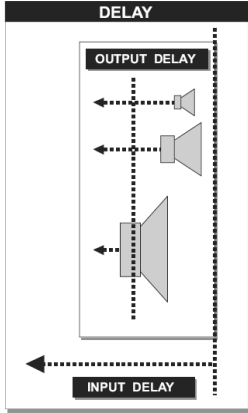

The Input Delay values can be set in the following ranges:

INPUT DELAY		
unit	range	step
m	0.0 ~ 900.0	0.5
mm	0 ~ 900000	7
ms	0 ~ 2621	1
us	0 ~ 2621438	21

The measurement unit can be chosen with the function Delay Unit (UTILITY menu-Units submenu).

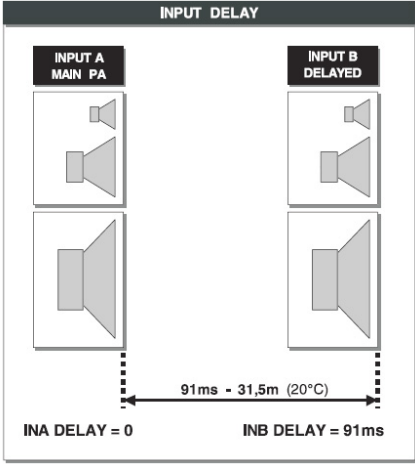

- **Output Delay:** Delays the signal only from a specific output. This is used to compensate for the distance between different speakers in the same sound system (ie. speaker clusters) or to correct internal alignment of speaker enclosure components.



The Output Delay values can be set in the following ranges:

OUTPUT DELAY		
unit	range	step
m	0.0 ~ 100.0	0.5
mm	0 ~ 100000	7
ms	0 ~ 291	1
us	0 ~ 291271	21

The Output Delay values can be set in the following ranges:

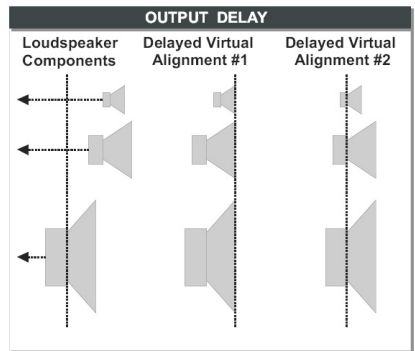
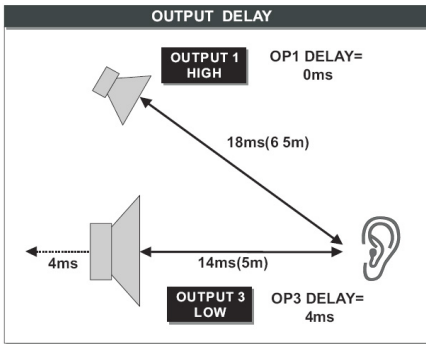

EDIT MENU

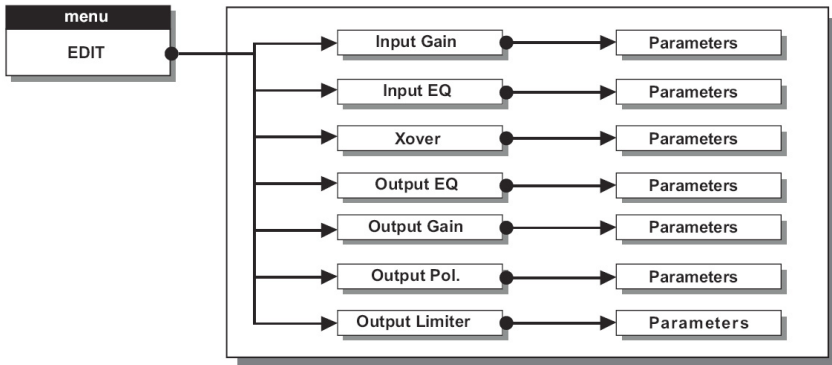

Input Noise Gate- Allows reduction of background noise generated by a unit connected to the processor's inputs (a mixer, for example). The filter is active when the input signal is below a certain threshold and reduces its level, cutting undesired background noises.

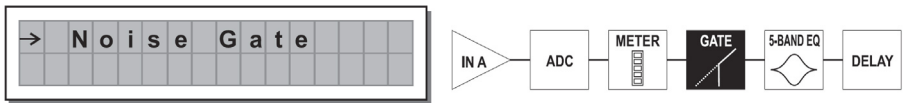

The following editable parameters are available, in two different pages:

a. Noise Gate ON/OFF

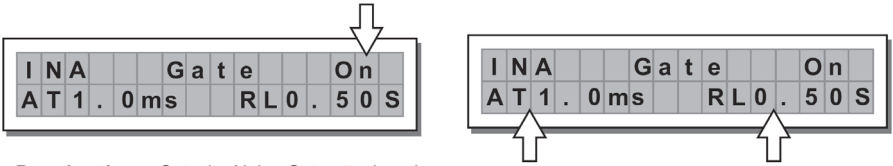

b. Reaction times- Sets the Noise Gate attack and release times.

- **ATTACK (AT):** The time needed by the filter to bring back the signal to its normal level when it goes above the threshold.
- **RELEASE (RL):** The time needed by the filter to cut the signal once it goes below the threshold.

Threshold- If the signal goes below the set threshold level, the Noise Gate reduces the signal. The editing values are within the following ranges: +8dBu -60dBu, with 2dBu steps.

Range- Sets the amount of the signal level reduction.

The editing values are within the following ranges: 0dBu -80dBu, with variable steps.

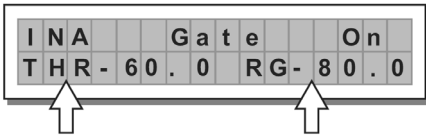

Input/Output EQ: Five band parametric EQ filters. Allows you to alter the overall tone of the signal.

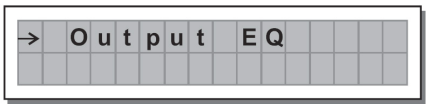
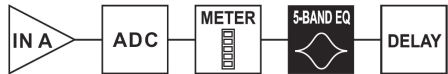

The following editable parameters are available for each filter:

- **Type of filter-** Select the filter to be Peaking, Low or High Shelving with a slope of 6 or 12 dB per octave and Notch filter.

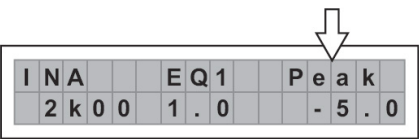

Peaking

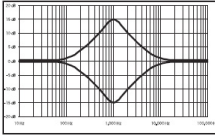

Low Shelving

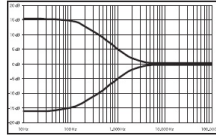

High Shelving

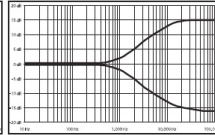

Notch

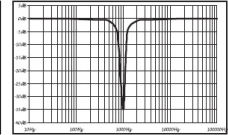

- **Center/Cutoff Frequency**- Selects the center frequency of the Peaking curve and Notch filter, or the cutoff frequency of Shelving curves.

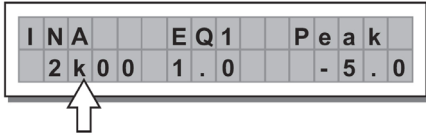

- **Bandwidth**- Sets the width of the Peaking or Notch type curve. This does not apply to Shelving curves

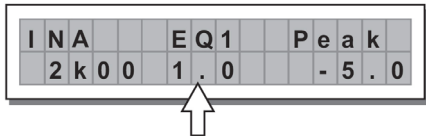

Peaking

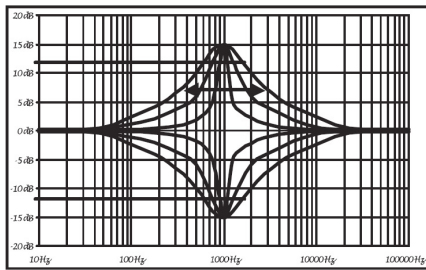

Notch

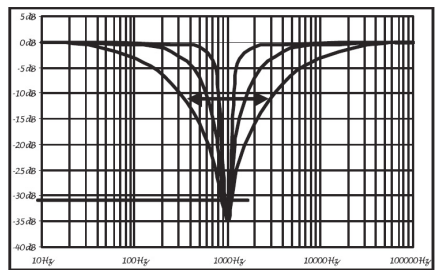

- **Gain**- Allows boost or cut of the selected frequencies. This does not apply when using the **Notch Filter**

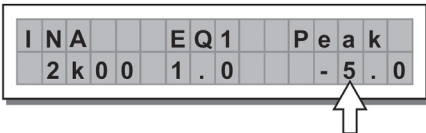

Peaking

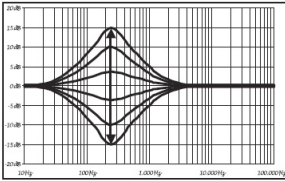

Low Shelving

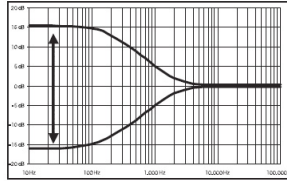

High Shelving

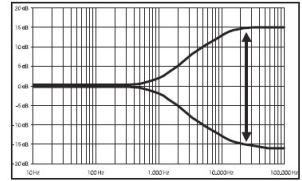

The filter values can be set in the following ranges:

5-BAND FULL PARAMETRIC EQ				
NAME	TYPE	GAIN	FREQ	WIDTH
Peak	Peaking	±15dB (step 0.5dB)	15.6Hz ~ 16kHz	0.05 ~ 3.00 oct (step 0.05 oct)
LoSh 6	Low Shelving 6dB/oct			
LoSh 12	Low Shelving 12dB/oct			
HiSh 6	High Shelving 6dB/oct			
HiSh 12	High Shelving 12dB/oct			
Notch	Notch Filter	- 45dB (fix)		0.05 ~ 3.00 oct (step 0.05 oct)

- **Xover**- Low-pass and high-pass filters.



Each Xover has 2 slightly different pages (one for each filter), where the name of the output it affects and the type of filter shown:

- **Low pass Filter** - Allows all the frequencies below a specific range to pass and cuts all other frequencies above it.

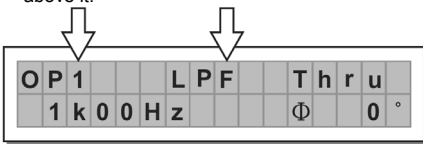

- **High Pass Filter**- The high-pass filter allows all the frequencies above a specific range to pass, and cuts all other frequencies below it.

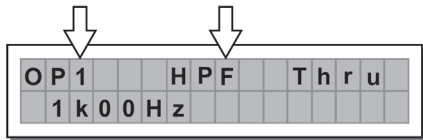

- **Crossover frequency** - Adjusts the filter cutoff frequency.

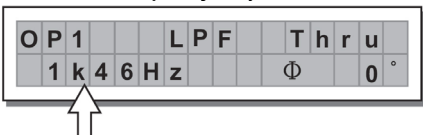

- **Phase** - Allows control of the signal's phase.

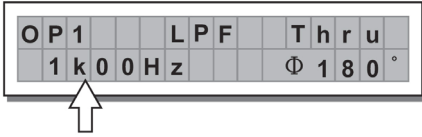

Note: This control is only available in the Low-Pass Filter window.

The Xover values can be set in the following ranges:

XOVER					
	NAME	TYPE	SLOPE	FREQ	PHASE
LPF	Thru			15.6Hz ~ 16KHz	0° ~ 180° (Stp 5°)
	But	Butterworth	6, 12, 18, 24 dB/oct		
	Bes	Bessel	12, 18, 24 dB/oct		
	LR	Linkwitz-Riley	12, 24, 48 dB/oct		
HPF	Thru			15.6Hz ~ 16KHz	
	Hish 6	Butterworth	6, 12, 18, 24 dB/oct		
	Hish 12	Bessel	12, 18, 24 dB/oct		
	Notch	Linkwitz-Riley	12, 24, 48 dB/oct		

Output Pol- Controls the output's polarity. Allows you to invert the phase of the signal on individual outputs. The effect operates with 5 steps in a range of between 0 and 180. In this way it's possible to set the phase of each individual output with 5 steps within a complete 360 revolution. This function is useful when assembling arrays of speaker enclosures, in the control of the interpolation between various enclosures or between sections of the same system.

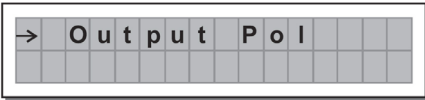

Output Limiter- Keeps the signal of each individual output within a set level.



- **Reaction times-** Adjusts between 3 types of Limiter reaction speeds:
 - Fast-** Suited for rapid Limiter operation, normally for signals dedicated to high frequencies.
 - Normal-** Suited for the majority of applications with signals dedicated to mid frequencies or full-range systems.
 - Slow-** Suited to avoid jumps in the level and for signals dedicated to low frequencies.

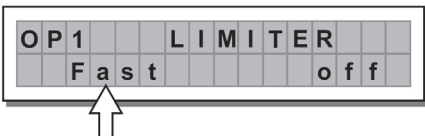

LIMITER	ATTACK	RELEASE
FAST	1 ms	10 ms
NORMAL	8 ms	80 ms
SLOW	45 ms	450 ms

- **Threshold**- Sets the level above which the Limiter activates.



IMPORTANT! Enabling the LIMITER on a specific output also changes the way in which the level is displayed on the corresponding LED. The level will no longer be the "absolute" output level, but the level of the signal at -24dB, -12dB, -6dB compared to the **LIMITER's threshold** (orange LIMIT LED), no matter what the threshold value is.

UTILITY MENU- Allows access to system options such as the control of the Multimedia Memory Card or protection against accidental or unauthorized changes.

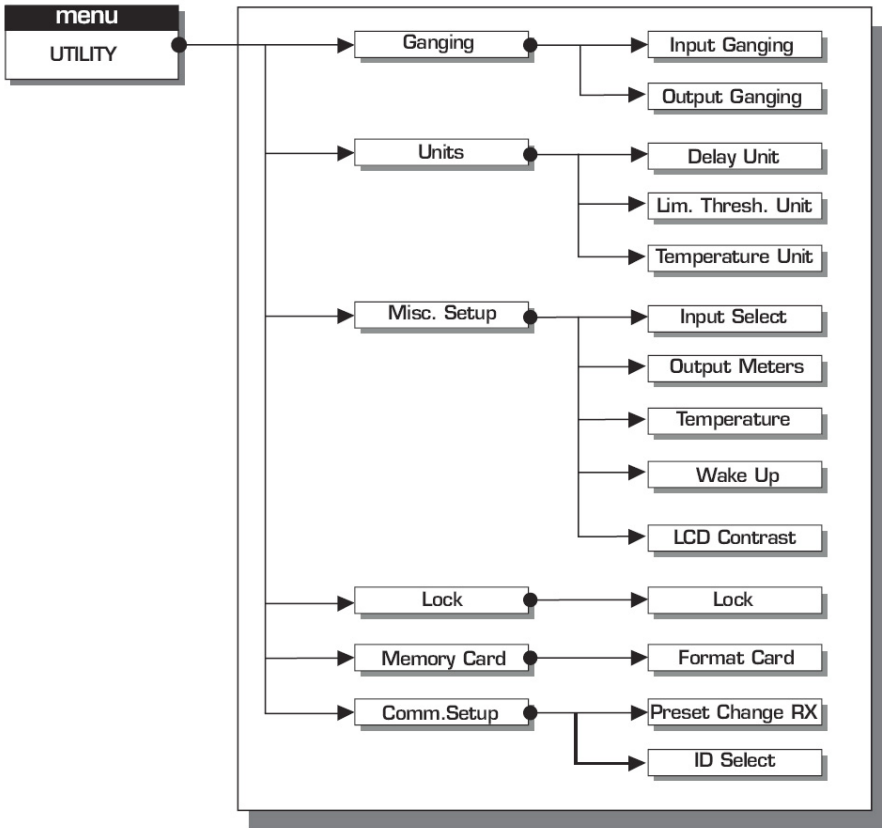

GANGING SUBMENU- Allows you to group together inputs and/or outputs. For example, this can be used to adjust the right and left sections of a stereo signal to the same Delay value or equalization on both inputs with just one operation; or set identical Xover parameters for the various outputs fed to a stereo sound system. The Ganging function can be enabled separately for both groups of input and groups of outputs.

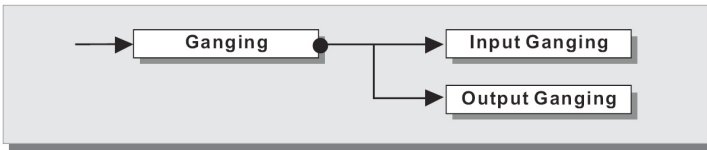

Input Ganging- Enables/disables the Ganging function on the inputs.
The settings are:

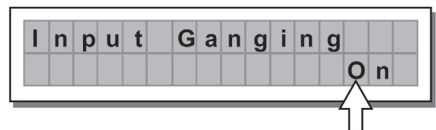
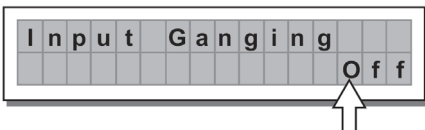

Output Ganging- Enables/disables the Ganging function on the outputs.

The settings are:

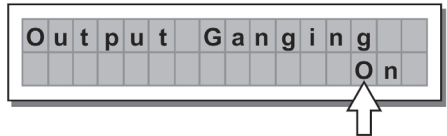

IMPORTANT:

As soon as Inputs and/or Outputs are ganged, the various menu pages only show the values that can actually be used.

UNITS SUBMENU

Choose the measurement units to be used with certain functions.

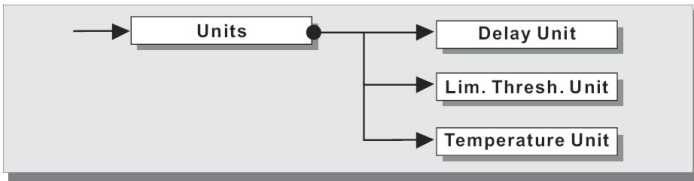

- **Delay Unit**- Sets the measurement in which Delays are expressed. The options include: **m** = meters - **mm** = millimeters - **ms** = milliseconds - **ms** = microseconds

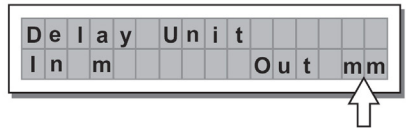
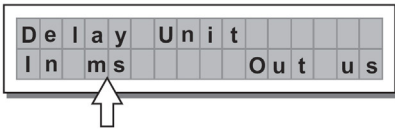

- **Lim. Thresh. Unit**- Sets the measurement units for the threshold of the Limiter (**EDIT** menu - **Output Limiter**).

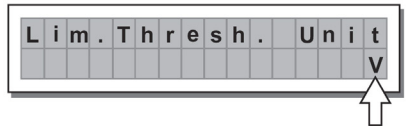
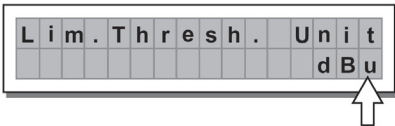

The options include: **dBu** = decibel (0 dBu = 0.775 V rms) - **V** = volt

- **Temperature Unit**- Sets the measurement units for the Temperature function (**UTILITY** menu - Misc. Setup submenu). The options include: **C** = degrees Centigrade - **F** = degrees Fahrenheit

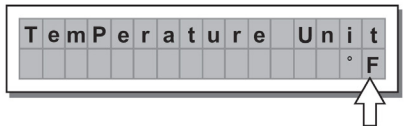
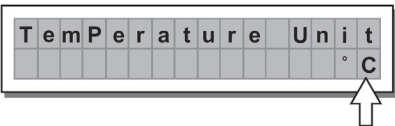

MISC. SETUP SUBMENU- Sets a series of system options.

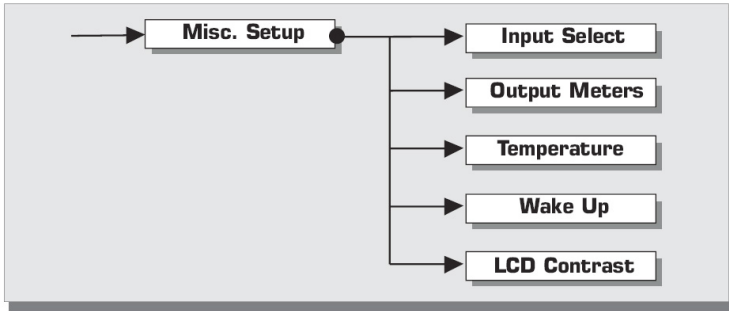

- **Input Select-** Choose the inputs which STAGEDRIVE+ should use, digital or analog.



- **Output Meters-** Choose whether to display the output signal before or after MUTE. The options include:

PreMute- the signal is always shown no matter what the MUTE status
PostMute- the signal is only shown if the output is not in MUTE

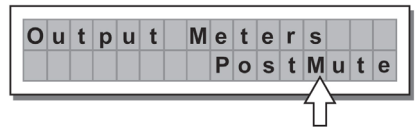
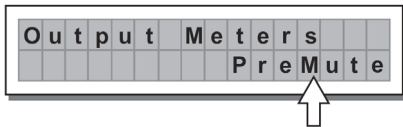

- **Temperature-** Sets the value of the environmental temperature at the place of installation to compensate for differentials due to the varying speed of sound transmission due to the air temperature. The editing values are in the following ranges: **+60 C ~ -30 C** with 1 C steps **140.0 F ~ -22.0 F** with 1.8 F steps

Note: The measurement units can be chosen between C (degrees Centigrade) and F (degrees Fahrenheit) by means of the Temperature Unit function (UTILITY menu - Units submenu).

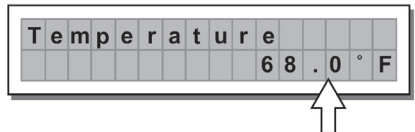
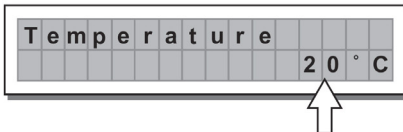

- **Wake Up-** Sets the mode in which MUTE functions are restored when the STAGEDRIVE+ is switched on. The options include:

Normal- When switched on, the system restores the last MUTE configuration before switching off
Mute- When switched on, the system automatically sets all the outputs in MUTE

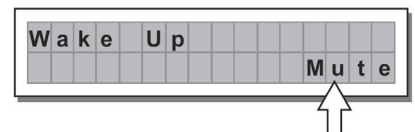
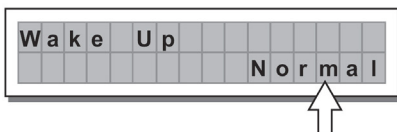

LCD Contrast- Adjusts the Display contrast.

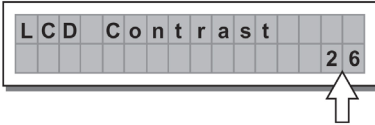

LOCK SUBMENU- Used to enable or disable the protection of the system against accidental or unauthorized changes.

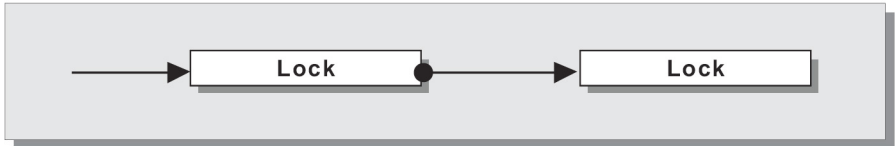

How to enable protection

1. Choose a protection mode (Partial or Total).
2. Use the ◀ and ▶ keys to access the area in which the **password** is entered.
3. The password can be made up of four alphanumerical characters, obtainable using the ◀ and ▶ keys and editable with the **DIAL**.
4. After entering the password, press **ENTER**.

Note: Confirmation is only accepted if the cursor is positioned on one of the four password characters. This prevents the accidental enabling of protection without having seen the password.

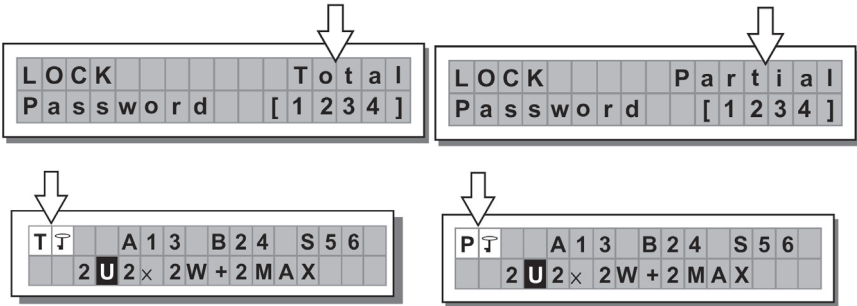

How to disable protection

1. Access the **LOCK** submenu.
2. The display shows the prompt for entering the password to unlock the protection.
3. Enter in the **password** using the combination of the < and > keys and the **DIAL**, then press **ENTER**.

Note: in the event of an incorrect password, the display prompts again, encrypting all the characters.

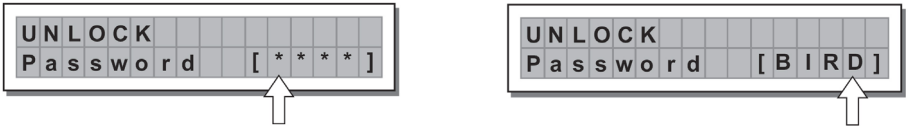

IMPORTANT! If you cannot remember the password, turn the unit on while pressing the "PREV" and "◀" keys. Now the protection is unlocked.

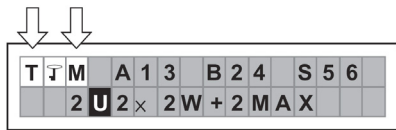

Note: Alongside the symbol of Total or Partial protection, the letter 'M' may also appear. This means that the system is protected, but the PRESET in question has undergone one or more changes that have not yet been stored. You can however switch the system on and off without any problems, as the current settings are kept in the buffer memory. Nevertheless, if this is your primary setup, it's advisable to store it in a PRESET.

MEMORY CARD SUBMENU- Allows formatting (erasing) of the Multimedia Memory Card. A card cannot be properly used by the system unless it is first formatted in the unit.

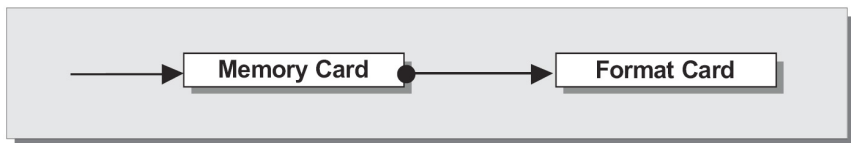

How to format the Card

1. Insert a Multimedia Memory Card in the slot.
2. In the Memory Card submenu, press **ENTER**
3. Press **ENTER** again to start formatting.
4. The system formats the card until it communicates that it has completed.

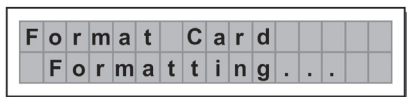

Note: in the event of an error or a Card fault, if there is no Card in the slot or if the Card is removed during formatting, the display shows the following message:



During formatting, the system automatically stores the *Default* PRESET in all the 128 CARD memory areas.

Note: since the system must always be configured, there are no empty memory areas. All the User and Card areas not yet used by stored user data are automatically occupied by the *Default* PRESET, which contains a standard start configuration with all the values of the various parameters at zero.

COMM. SETUP SUBMENU

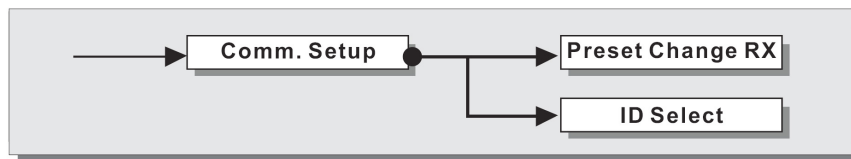

This submenu allows access to the setting of communication with other units via the RS485 ports.

Note: Dump Out Preset and the Incoming Dump functions are an exception, as they're controlled directly in the PRESET menu.

PRESET Change RX

Allows you to accept or ignore the PRESET Change command sent via a computer's USB port or another STAGEDRIVE+ when it loads a PRESET. The settings can be:

- Ignore PRESET Change commands received.

- Accept and execute PRESET Change commands.

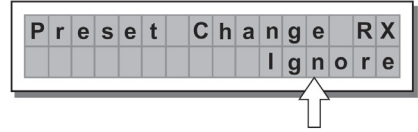
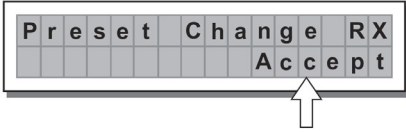

SOFTWARE DRIVER SETUP

1. Insert the included software CD into your computer's disc drive.
2. Navigate to the MaxiDrive3.4 DPA software/USB Driver folder to locate and install the PL-2303 Driver Installer.exe associated with your version of Windows.
3. Once the driver is installed, power on the STAGEDRIVE+ and connect the USB cable from the STAGEDRIVE +’s USB port to your PC’s USB port.
4. Right click on **MY COMPUTER** then click **PROPERTIES**.
5. Click the **HARDWARE** tab, then select **DEVICE MANAGER**.
6. Double click **PORTS (COM & LPT)**, and look for **PROLIFIC USB-to-SERIAL Com Port**
7. Double click **PROLIFIC USB-to-SERIAL Com Port**, then click **PORT SETTINGS**, then click **ADVANCED**.
8. Change the **COM PORT NUMBER** to **COM1** (or any other com port not in use) and click Ok.

SOFTWARE SETUP

The software editor can be setup as seen below:

1. Once the software driver has been installed (with the STAGEDRIVE+ powered on and connected to the computer via USB), launch the software editor program.
2. Select **New**

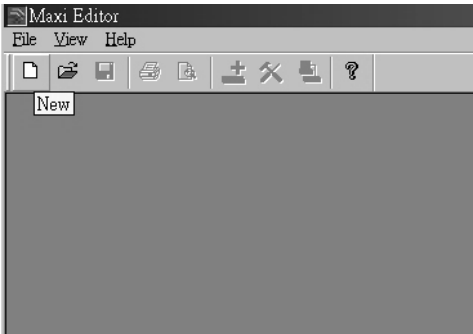

3. Select your interface from the list.

4. Select **Network Scan**

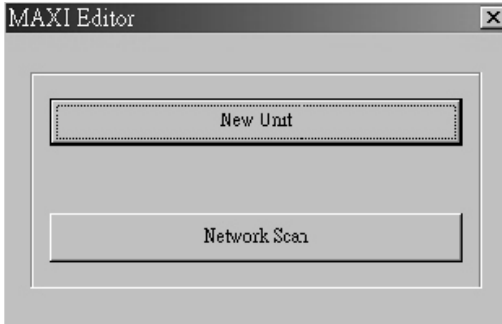

5. If the Network Scan fails, check the **Device ID number**. Select **New Unit**, selecting the Interface. Make sure the STAGEDRIVE+ ID number is 1 or matches the Device ID number.

6. Select **OK**, entering the next interface:

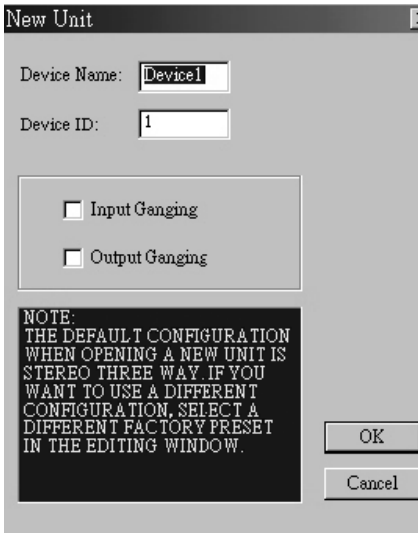

7. Select the **Options icon**, entering the next interface:



8. Select **Rs232** with the COM setting that you chose during the software driver setup for the Port and 38400 (or 19200) for Baud Rate.
NOTE: Make sure the settings on the computer match what is set in the STAGEDRIVE+

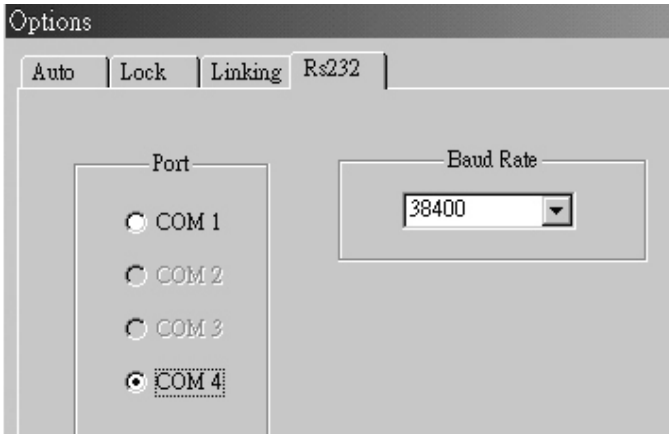

9. Select the **On/Off Line** on the main interface after selecting **OK**.

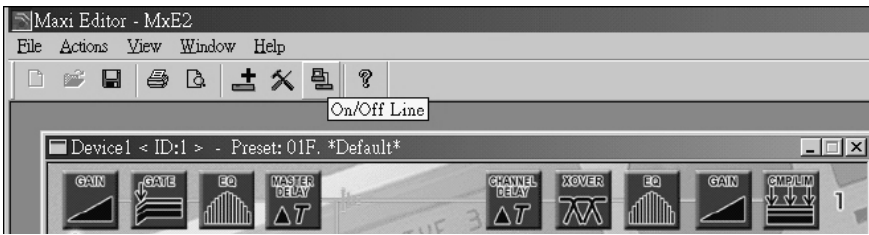

10. It will display the interface. Select **OK** then it will link to the equipment.

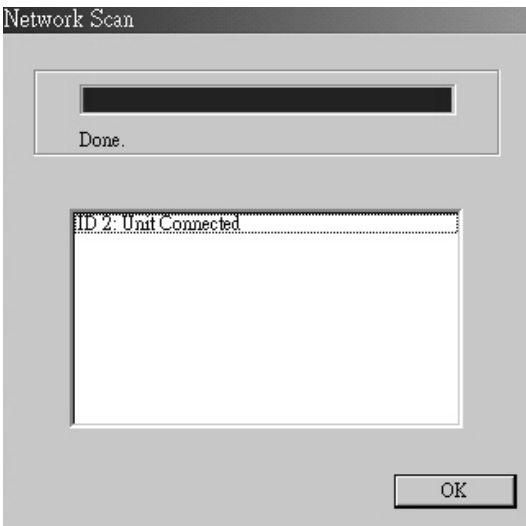

11. When the link is connected, it will display ONLINE.



CONNECTION EXAMPLES

The following examples will help you connect and use STAGEDRIVE+.
A13 B24 S56 2-WAY STEREO+2 MONO AUX [2 2W+2MAX]

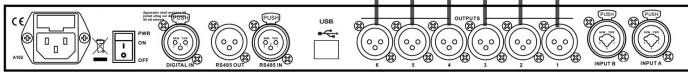
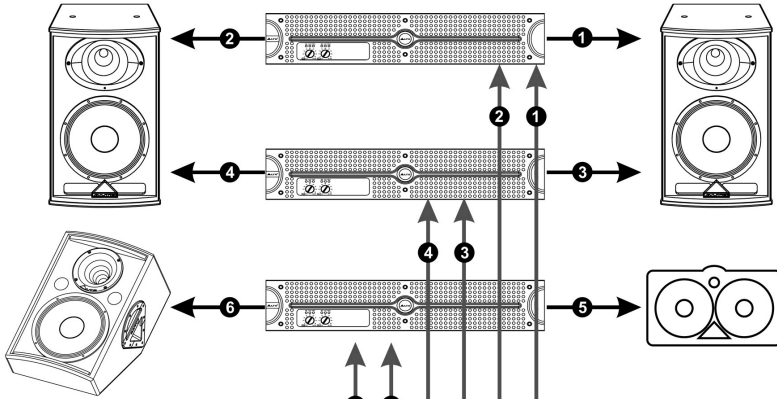
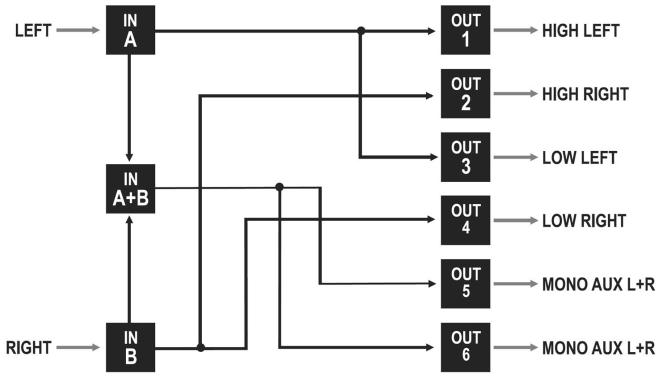

STAGEDRIVE+

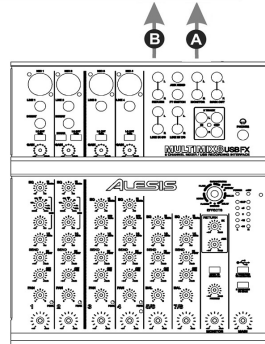

A135 B246 3-WAY STEREO [2X3W]

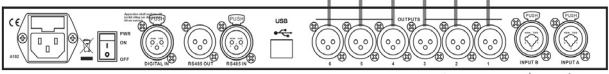
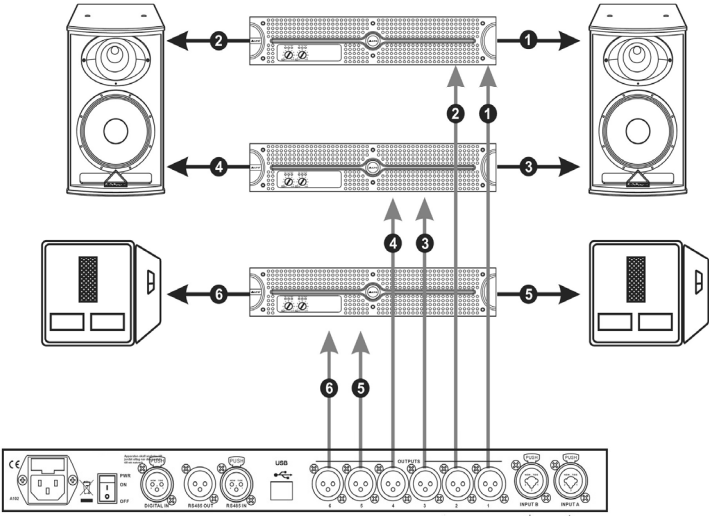
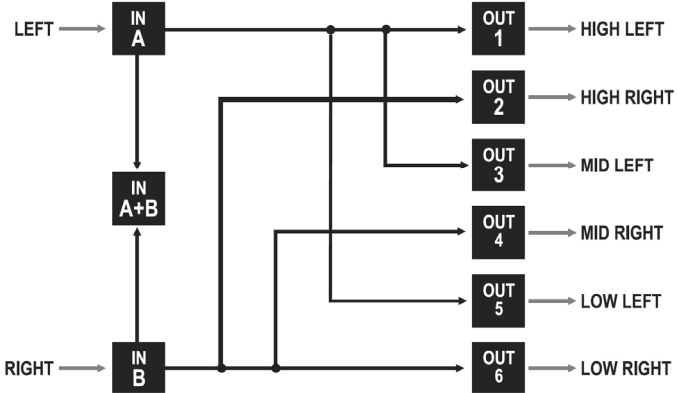

STAGEDRIVE+

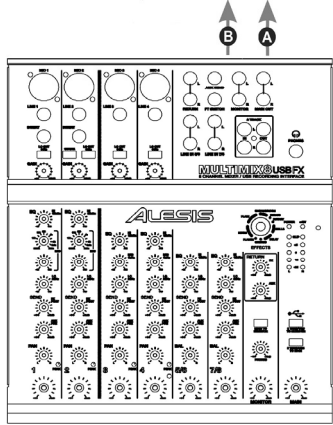
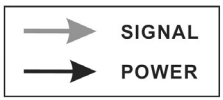

A13 B24 S56 3-WAY STEREO with MONO SUB+MONO AUX [2 3W+MSB+MAX]

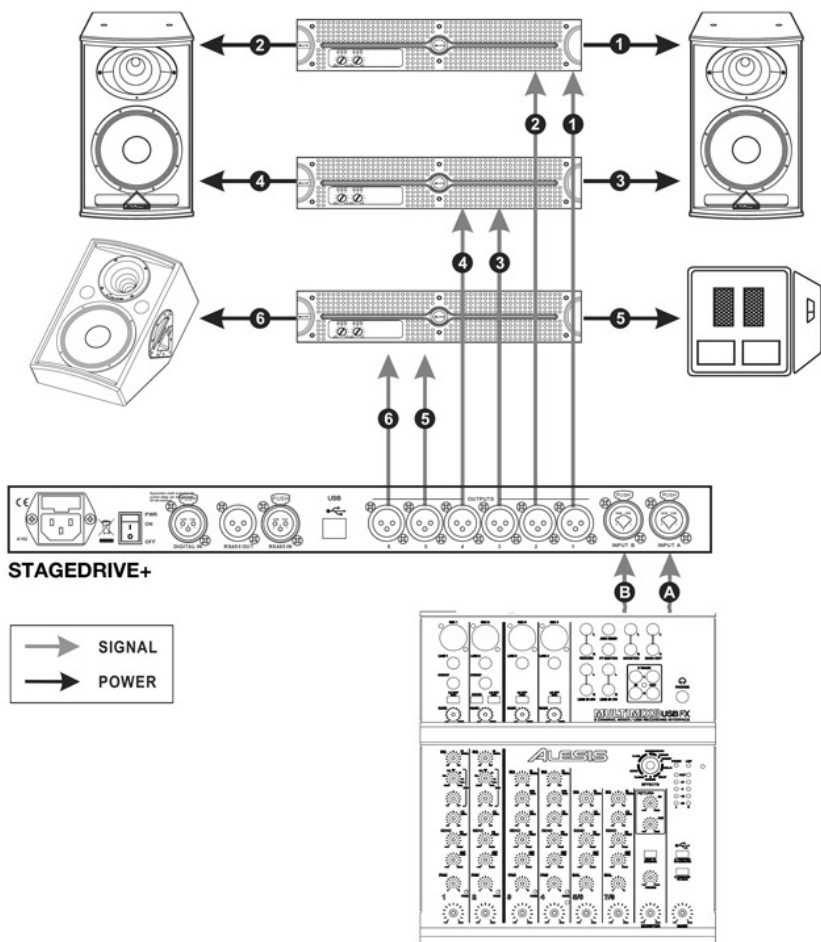

A1324 S56 4-WAY 4 MONO + 2 MONO AUX [4W+2MAX]

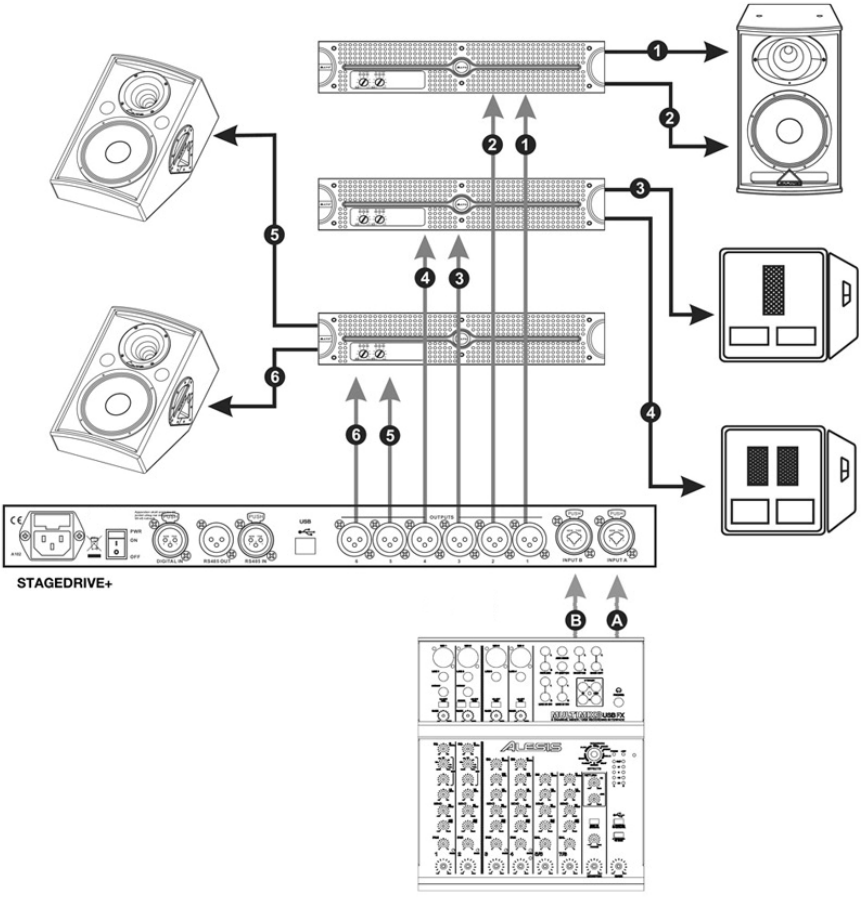
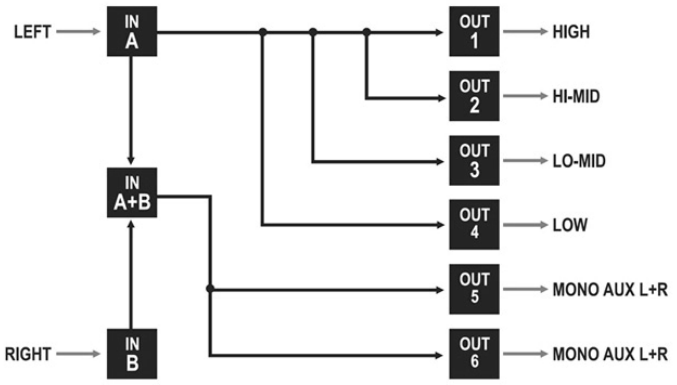

A135 B246 3-WAY STEREO [2x2W]

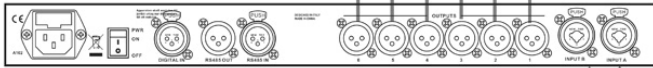
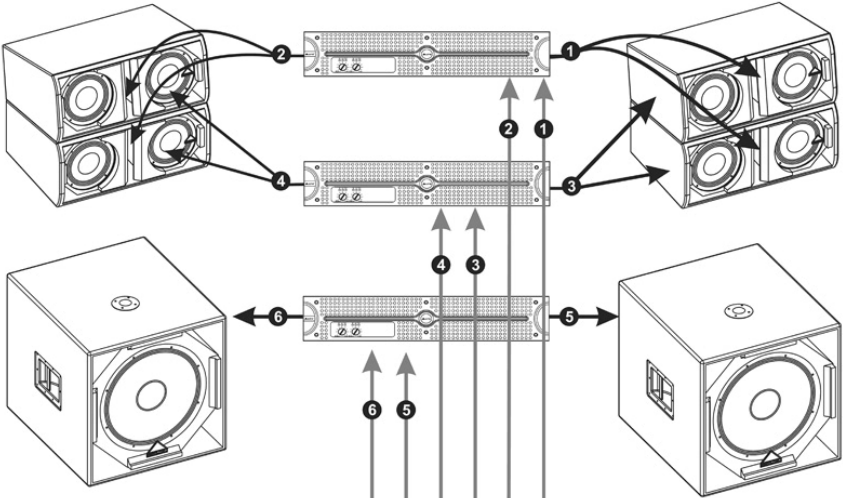
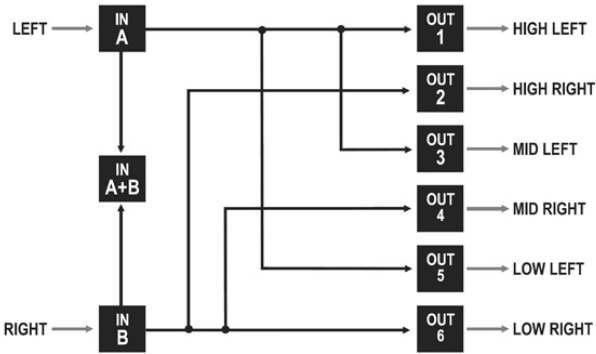

STAGEDRIVE+

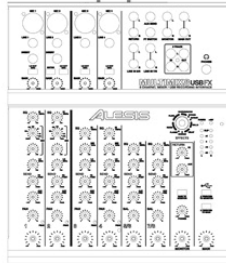

GUÍA DE INICIO RÁPIDO (ESPAÑOL)

CONTENIDO DE LA CAJA

- STAGEDRIVE+
- Cable de alimentación
- CD de software
- Guía de inicio rápido
- Folleto de información sobre la seguridad y la garantía

INSTALACIÓN RÁPIDA

1. Asegúrese de que todos los artículos indicados en CONTENIDO DE LA CAJA estén incluidos en la misma.
2. **LEA EL FOLLETO DE INFORMACIÓN SOBRE LA SEGURIDAD Y LA GARANTÍA ANTES DE UTILIZAR EL PRODUCTO.**
3. Estudie el diagrama de conexión incluido en esta guía.
4. Coloque todos los dispositivos en una posición adecuada para su funcionamiento.
5. Asegúrese que todos los dispositivos estén apagados y que todos los atenuadores (faders) y perillas de ganancia estén en posición "cero".
6. Conecte las salidas de todas las fuentes de sonido a las entradas del amplificador, como se indica en el diagrama.
7. Conecte las salidas del amplificador a los altavoces.
8. Enchufe todos los dispositivos a un suministro eléctrico apropiado.
9. Encienda todo en el siguiente orden:
 - Fuentes de sonido (por ejemplo, micrófonos, giradiscos, reproductores de CD, etc.)
 - Mezclador
 - Amplificador
 - Altavoces
10. Al apagar los equipos, apague los mismos en el siguiente orden:
 - Altavoces
 - Amplificador
 - Mezclador
 - Fuentes de sonido

DIAGRAMA DEL PANEL FRONTAL

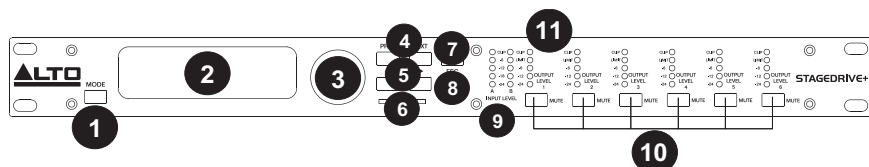

1. **BOTÓN DE MODO**- Permite seleccionar uno de cuatro modos: PRESET (Preprogramación), DELAY (Retardo), EDIT (Edición) y UTILITY (Utilidad).
2. **PANTALLA**- Muestra las páginas de los diversos menús y sus parámetros.
3. **PERILLA DEL DIAL**- Se utiliza para editar el valor del parámetro seleccionado.
4. **BOTÓN ANTERIOR/SIGUIENTE**- Permite acceder a las páginas y/o parámetros de menú.
5. **TECLAS DEL CURSOR DE NAVEGACIÓN**- Permiten seleccionar diversos parámetros.
6. **RANURA PARA TARJETA DE MEMORIA**- Ranura para tarjeta MMC usada para almacenar los PRESET.
7. **TECLA ENTER**- Permite confirmar la edición de parámetros.
8. **TECLA DE ESCAPE**- Permite salir de la página de edición seleccionada o cancelar una operación de edición.
9. **LED DE NIVEL DE ENTRADA**- Muestran el nivel de la entrada A/B.
10. **INTERRUPTORES DE SILENCIAMIENTO**- Permiten silenciar la señal de cualquiera de las seis salidas respectivas.
11. **LED DE NIVEL DE SALIDA**- Muestran el nivel de salida.

Nota: El LIMITADOR cambia la manera en que se muestra el nivel de salida en el LED correspondiente. El nivel mostrado en el medidor no es más el nivel de salida "absoluto" sino el nivel de la señal a -24 dB, -12 dB y -6 dB comparado con el umbral del limitador (indicado por el LED anaranjado LIMIT [Límite]).

DIAGRAMA DEL PANEL TRASERO

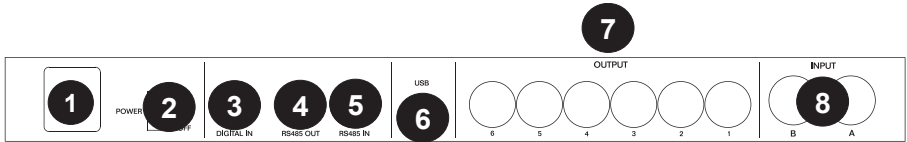

- ENTRA DE CA Y PORTAFUSIBLE-** Conecte aquí el cable de alimentación incluido.
PRECAUCIÓN: Si es necesario reemplazar el fusible, solicite la asistencia de un técnico calificado. El fusible continúa quemándose después del reemplazo, deje de usar esta unidad y solicite su reparación.
- INTERRUPTOR DE ENCENDIDO-** Se utiliza para encender y apagar la unidad.
- ENTRADA DIGITAL-** Conecte aquí un cable XLR-F balanceado.
- SALIDA RS485-** Permite la comunicación saliente entre una unidad STAGEDRIVE+ y otras unidades STAGEDRIVE+.
- ENTRADA RS485-** Permite la comunicación saliente entre una unidad STAGEDRIVE+ y otras unidades STAGEDRIVE+.
- PUERTO USB-** Permite la comunicación vía PC.
- SALIDAS-** Use en estas salidas cables XLR-M balanceados.
- ENTRADAS-** Conectores combo XLR balanceado - ¼".

PARA COMENZAR

Cómo ajustar la señal de entrada

- Mantenga las salidas de STAGEDRIVE+ en estado **MUTE** (Silenciamiento) (LED encendidos) pulsando cada botón MUTE respectivo en el panel frontal.
- Aplique una señal a la entrada del STAGEDRIVE+ y observe el medidor de LED **INPUT LEVEL** (Nivel de entrada) A-B.
- Mantenga alta la señal pero sin disparar el LED **CLIP** (Recorte) continuamente, ajustando la ganancia de entrada si es necesario.
- Pulse la tecla **MODE** (Modo) hasta que se encienda el LED de menú **EDIT** (Edición). Use las teclas **PREV** (Anterior) y **NEXT** (Siguiete) para ir a la página **Input Gain** (Ganancia de entrada) y pulse **ENTER**.
- Use el **DIAL** para cambiar el valor de ganancia y observe el nivel de la señal en el medidor de LED hasta que se alcancen los valores ideales.
- Use las teclas **PREV** y **NEXT** para acceder a la página **INB Gain** (Ganancia de la entrada B).

MENÚS

Menú PRESET (Preprogramación)

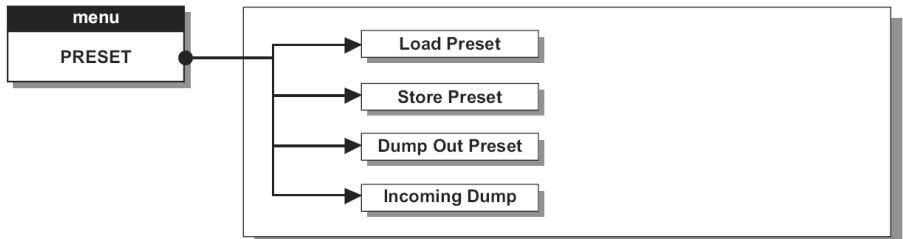

Tipos de PRESET

Hay 3 categorías de PRESET:

- **F** = PRESET (valores predeterminados) de fábrica que no se pueden cambiar permanentemente. Son los puntos de partida para crear PRESET del usuario y PRESET de tarjeta desde cero.
- **U** = PRESET del usuario, que éste puede programar.
- **C** = PRESET de tarjeta, que el usuario puede programar y guardar en una tarjeta de memoria multimedia.

Para cargar un PRESET:

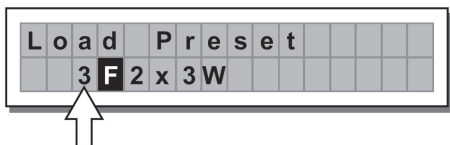

- Use el DIAL para seleccionar un PRESET de fábrica (indicado por la letra F) y pulse ENTER para cargar el preset en la memoria.

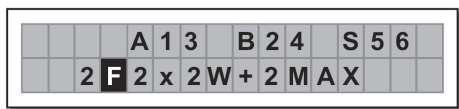

Cómo ajustar la señal de entrada



1. Mantenga las salidas del STAGEDRIVE+ en estado MUTE (LED encendidos).
2. Aplique una señal a la entrada del STAGEDRIVE+ y observe el medidor de LED.
3. Para obtener un nivel de señal correcto, asegúrese de que el LED CLIP de INPUT LEVEL A-B no se encienda continuamente.
4. Busque el ajuste de nivel de salida correspondiente a su mezclador (u otra unidad) y conéctelo a la entrada del STAGEDRIVE+.
5. Ajuste la ganancia de entrada del STAGEDRIVE+ pulsando la tecla MODE hasta que se encienda el LED de menú EDIT.
6. Use las teclas PREV y NEXT para ir a la página Input Gain:
7. Pulse ENTER. La pantalla muestra la página IN A Gain (Ganancia de la entrada A) o IN A&B Gain (Ganancia de las entradas A y B) (de acuerdo a la configuración y otras utilidades cargadas en la memoria):
8. Use el DIAL para cambiar el valor de ganancia y observe el nivel de la señal en el medidor de LED hasta que se alcancen los valores ideales. Use entonces las teclas PREV y NEXT para acceder a la página IN B Gain (si existe, lo que depende de la configuración y las demás utilidades cargadas en la memoria).

Para guardar un PRESET:

1. Use el DIAL para seleccionar el área donde se va a guardar el PRESET y pulse ENTER.
2. Use las teclas ◀ y ▶ para posicionar el cursor en un carácter y use el DIAL para ingresar el valor alfanumérico.
3. Edite el nombre del PRESET si lo desea y pulse ENTER para guardar los cambios o pulse ESC para cancelar.

P	r	e	s	e	t	N	a	m	i	n				
[2	x	2	W	+	2	M	A	X]				

Submenú COMM. SETUP (Configuración de comunicaciones) - Este submenú permite acceder a la configuración de la comunicación con otras unidades a través del puerto USB. **Nota:** Las funciones 'Dump Out Preset' (Descargar preset) y 'Incoming Dump' (Descarga entrante) son excepciones, porque se controlan directamente en el menú PRESET.

Transmit PRESETS (Transmitir presets) - Use este menú para transmitir PRESETS por los puertos RS485 a fin de copiar dichos PRESETS en otro STAGEDRIVE+.

Para descargar un PRESET- Seleccione un PRESET usando el DIAL y pulse ENTER.
Nota: La página de menú permanece sin cambios para permitir descargar otros PRESET. Todos los datos del preset (nombre, configuración, valores de parámetros, etc.) se transmiten inmediatamente a las unidades conectadas al puerto RS485.

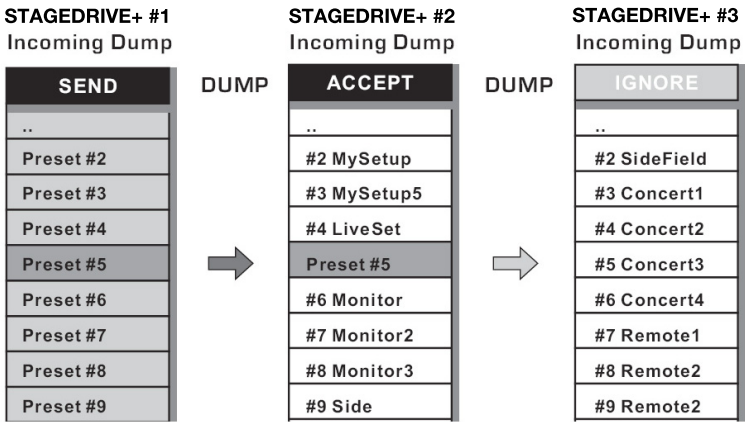

Nota: A fin de que la transferencia funcione, las unidades receptoras deben tener capacidad para identificar y aceptar operaciones de descarga entrantes. Cuando se conectan dos o más STAGEDRIVE+, el PRESET enviado por el STAGEDRIVE+ transmisor sobrescribe el PRESET existente en la misma posición de memoria del STAGEDRIVE+ receptor.

D	u	m		O	u	t		P	r	e	s	e	t
	2	U		2	x	2	W	+	2	M	A	X	

↑

Descarga entrante

Acepta o ignora la descarga de un PRESET enviado desde otro STAGEDRIVE+ por el puerto RS485 o desde una computadora por USB. Las configuraciones de los puertos pueden ser:

- Ignorar los datos que se envían
- Aceptar los datos que se envían

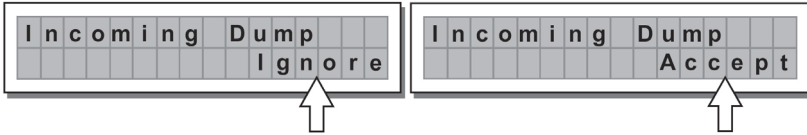

Protección del sistema

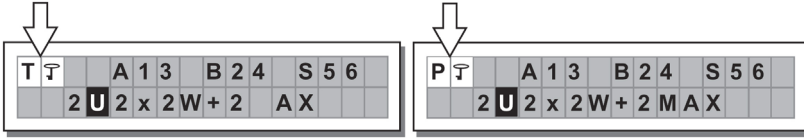

Estas indicaciones aparecen cuando está activada la función **LOCK** (Bloqueo), (cuando el sistema LOCK UTILITY [Utilidad de bloqueo] está total (T) o parcialmente (P) protegido contra cambios accidentales o no autorizados). La protección se establece usando una contraseña, sin la cual no se puede realizar la edición.

MENÚ DELAY (Retardo)

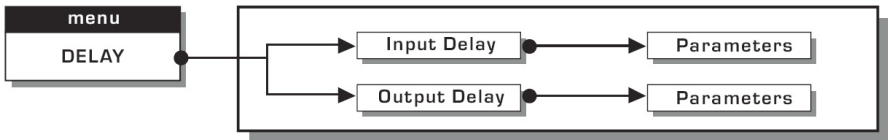

Input Delay (Retardo de entrada): Retarda la señal de una entrada (o la suma de las entradas) antes de enviarla al sistema de enrutamiento. Todas las salidas se retardan en el mismo tiempo. Esto se usa habitualmente para compensar las distancias entre los gabinetes de altavoces o los auditorios grandes.

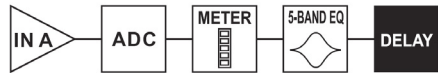
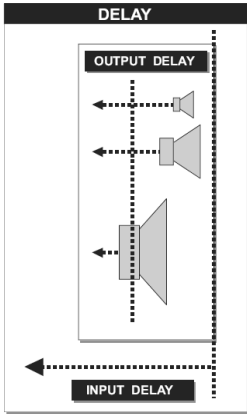

Entrada A ▶ Conversor analógico-digital ▶ Medidor de LED ▶ Ecuador de 5 bandas ▶ Retardo

Los valores del retardo de entrada se pueden ajustar en los siguientes rangos:

INPUT DELAY		
unit	range	step
m	0.0 ~ 900.0	0.5
mm	0 ~ 900000	7
ms	0 ~ 2621	1
us	0 ~ 2621438	21

La unidad de medida se puede elegir con la función Delay Unit (Unidad de retardo (menú UTILITY -submenú Units).

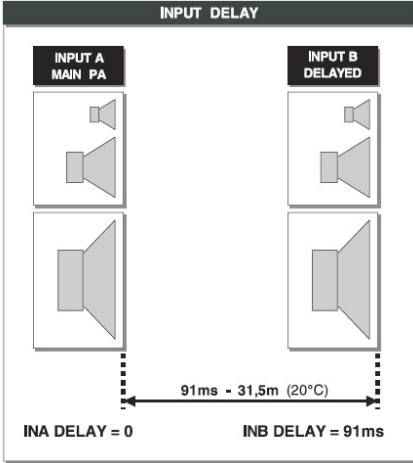

- **Output Delay** (Retardo de salida): Retarda la señal sólo de una salida específica. Esto se usa para compensar la distancia entre distintos altavoces del mismo sistema de sonido (es decir, agrupamientos de altavoces) o para corregir la alineación interna de componentes de los gabinetes de altavoces.



Retardo ▶ Filtro pasabajos ▶ Filtro pasaaaltos ▶ Ecualizador de 5 bandas ▶ Nivel ▶ Polaridad ▶ Limitador ▶ Medidor de LED ▶ Silenciamiento ▶ Convertor analógico-digital ▶ Salida

Los valores del retardo de salida se pueden ajustar en los siguientes rangos:

OUTPUT DELAY		
unit	range	step
m	0.0 ~ 100.0	0.5
mm	0 ~ 100000	7
ms	0 ~ 291	1
us	0 ~ 291271	21

Los valores del retardo de salida se pueden ajustar en los siguientes rangos:

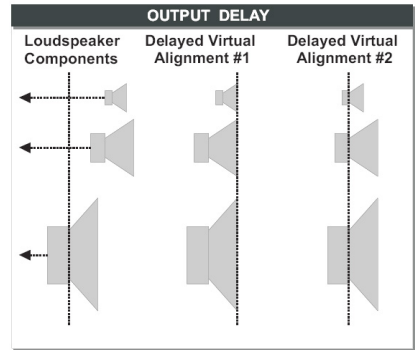
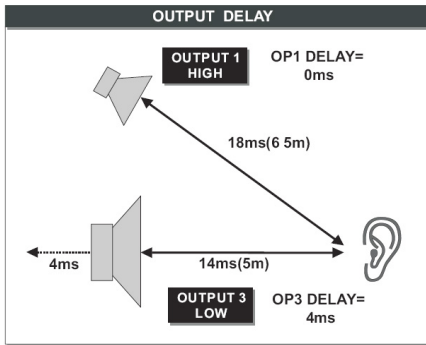

MENÚ EDIT (Edición)

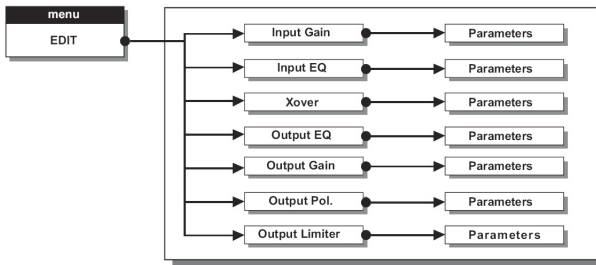

Input Noise Gate (Compuerta de ruido de entrada) - Permite la reducción del ruido de fondo generador por una unidad conectada a las entradas del procesador (un mezclador, por ejemplo). El filtro está activo cuando la señal de entrada está por debajo de un cierto umbral y reduce su nivel, cortando los ruidos de fondo indeseados.

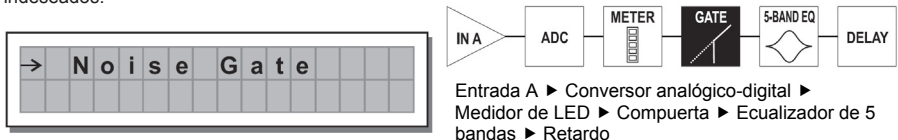

Están disponibles los siguientes parámetros editables, en dos páginas diferentes:

a. Noise Gate ON/OFF (Compuerta de ruido sí/no)

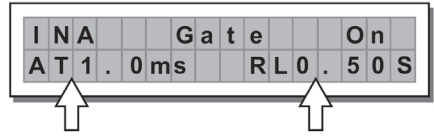
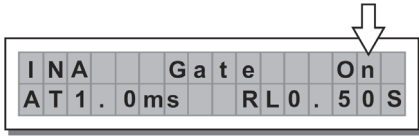

b. Reaction times (Tiempos de reacción) - Ajusta los tiempos de ataque y liberación de la compuerta de ruido.

- **ATAQUE (AT):** Tiempo que necesita el filtro para retrotraer la señal a su nivel normal cuando supera el umbral.
- **CORTE (RL):** Tiempo que necesita el filtro para cortar la señal una vez que cae por debajo del umbral.

Threshold (Umbral) - Si la señal cae por debajo del nivel de umbral ajustado, la compuerta de ruido reduce la señal. Los valores de edición están dentro de los rangos siguientes: +8 dBu -60 dBu, con pasos de 2 dBu.

Range (Rango) - Establece la magnitud de la reducción del nivel de la señal. Los valores de edición están dentro de los rangos siguientes: 0 dBu -80 dBu, con pasos variables.

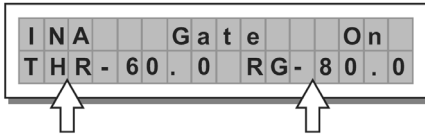

Input/Output EQ (Ecuador de entrada/salida): Filtros de ecualización paramétrica de cinco bandas. Le permiten alterar el tono general de la señal.

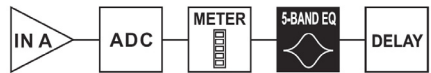
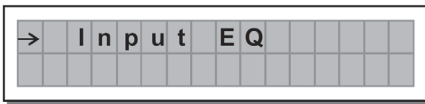

Entrada A ▶ Convertor analógico-digital ▶ Medidor de LED ▶ Ecuador de 5 bandas ▶ Retardo

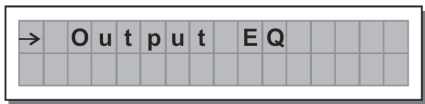

Retardo ▶ Filtro pasabajos ▶ Filtro pasaaaltos ▶ Ecuador de 5 bandas ▶ Nivel ▶ Polaridad ▶ Limitador ▶ Medidor de LED ▶ Silenciamiento ▶ Convertor analógico-digital ▶ Salida

Se dispone de los siguientes parámetros editables para cada filtro:

- **Type of filter** (Tipo de filtro) - Permite seleccionar el filtro como Peaking (de pico), Low o High Shelving (tipo "repisa" alto y bajo) con una pendiente de 6 ó 12 dB por octava y filtro supresor de banda.

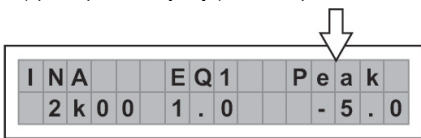

Pico
Peaking

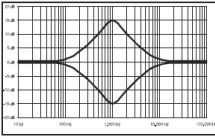

Shelving bajo
Low Shelving

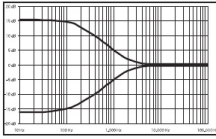

Shelving algo
High Shelving

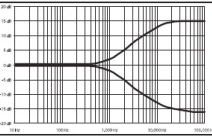

Supresor de banda
Notch

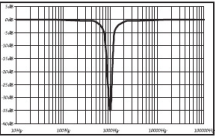

- **Center/Cutoff Frequency** (Frecuencia central/de corte) - Selecciona la frecuencia central de la curva de pico y el filtro supresor de banda, o la frecuencia de corte de las curvas de shelving (repisa).

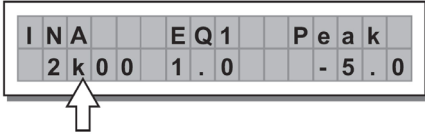

- **Bandwidth** (Ancho de banda) - Ajusta el ancho de banda de la curva de pico o supresión de banda. No se aplica a las curvas de shelving.

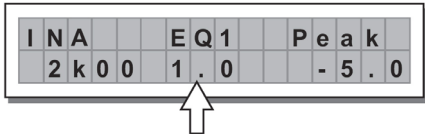

Pico

Peaking

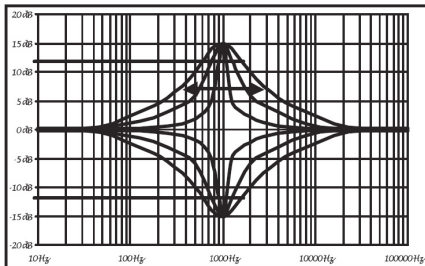

Supresor de banda

Notch

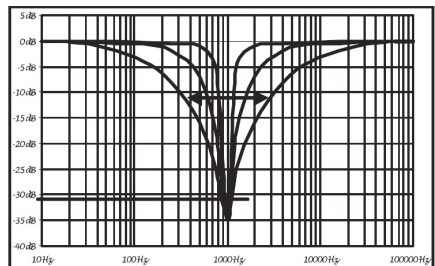

- **Gain** (Ganancia) - Permite reforzar o cortar las frecuencias seleccionadas. No se aplica cuando se usa el **filtro supresor de banda**

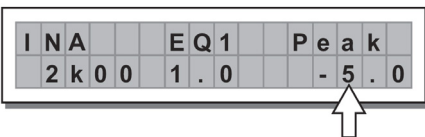

Pico Peaking

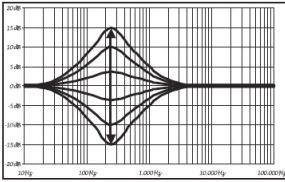

Shelving bajo Low Shelving

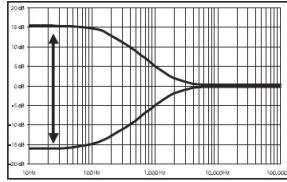

Shelving alto High Shelving

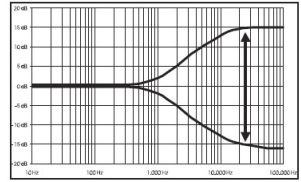

Los valores del filtro se pueden ajustar en los siguientes rangos:

5-BAND FULL PARAMETRIC EQ				
NAME	TYPE	GAIN	FREQ	WIDTH
Peak	Peaking	±15dB (step 0.5dB)	15.6Hz ~ 16kHz	0.05 ~ 3.00 oct (step 0.05 oct)
LoSh 6	Low Shelving 6dB/oct			
LoSh 12	Low Shelving 12dB/oct			
HiSh 6	High Shelving 6dB/oct			
HiSh 12	High Shelving 12dB/oct			0.05 ~ 3.00 oct (step 0.05 oct)
Notch	Notch Filter			

- **Xover-** Filtros pasabajos y pasaaltos.



Retardo ▶ Filtro pasabajos ▶ Filtro pasaaltos ▶ Ecualizador de 5 bandas ▶ Nivel ▶ Polaridad ▶ Limitador ▶ Medidor de LED ▶ Silenciamiento ▶ Conversor analógico-digital ▶ Salida



Cada Xover tiene 2 páginas ligeramente diferentes (una para cada filtro), donde se muestran el nombre de la salida que afecta y el tipo de filtro:

- **Low pass Filter** (Filtro pasabajos) - Permite pasar las frecuencias inferiores a un rango específico y corta todas las demás frecuencias superiores al mismo.

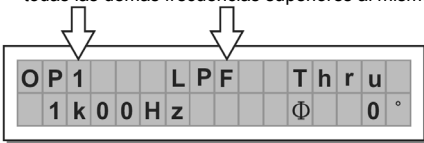

- **High pass Filter** (Filtro pasaaltos) - Permite pasar las frecuencias superiores a un rango específico y corta todas las demás frecuencias inferiores al mismo.

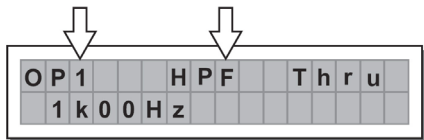

- **Crossover frequency (Frecuencia de cruce)** - Ajusta la frecuencia de corte del filtro.

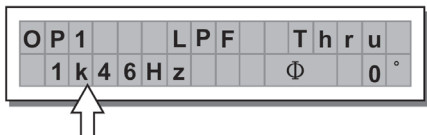

- **Phase (Fase)** - Permite el control de la fase de la señal.

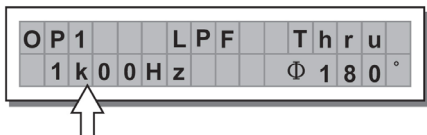

Nota: Este control está disponible únicamente en la ventana del filtro pasabajos.

Los valores Xover se pueden ajustar en los siguientes rangos:

XOVER					
	NAME	TYPE	SLOPE	FREQ	PHASE
LPF	Thru			15.6Hz ~ 16KHz	0° ~ 180° (Stp 5°)
	But	Butterworth	6, 12, 18, 24 dB/oct		
	Bes	Bessel	12, 18, 24 dB/oct		
	LR	Linkwitz-Riley	12, 24, 48 dB/oct		
HPF	Thru			15.6Hz ~ 16KHz	
	Hish 6	Butterworth	6, 12, 18, 24 dB/oct		
	Hish 12	Bessel	12, 18, 24 dB/oct		
	Notch	Linkwitz-Riley	12, 24, 48 dB/oct		

Output Pol (Polaridad de salida) - Controla la polaridad de la salida. Le permite invertir la fase de la señal en las salidas individuales. El efecto funciona con 5 pasos en un rango entre 0 y 180. De esta manera, es posible ajustar la fase de cada salida individual con 5 pasos dentro de una vuelta completa de 360 grados. Esta función es útil cuando se arman arreglos de gabinetes de altavoces, en el control de la interpolación entre varios gabinetes o entre secciones del mismo sistema.

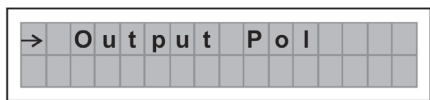

Output Limiter (Limitador de salida) - Mantiene la señal de cada salida individual dentro de un nivel establecido.

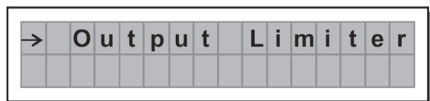

- **Reaction times** (Tiempos de reacción) - Ajusta entre 3 tipos de velocidades de reacción del limitador:
 - Fast (Rápido)** - Adecuado para la operación rápida del limitador, normalmente para señales dedicadas a altas frecuencias.
 - Normal** - Adecuado para la mayoría de las aplicaciones con señales dedicadas a sistemas de frecuencias medias o de gama completa.
 - Slow (Lento)** - Adecuado para evitar saltos en el nivel y para señales dedicadas a bajas frecuencias.

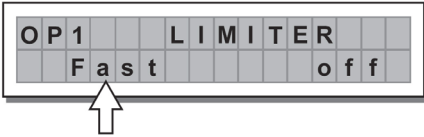

LIMITER	ATTACK	RELEASE
FAST	1 ms	10 ms
NORMAL	8 ms	80 ms
SLOW	45 ms	450 ms

- **Threshold** (Umbral) - Establece el nivel por encima del cual se activa el limitador.

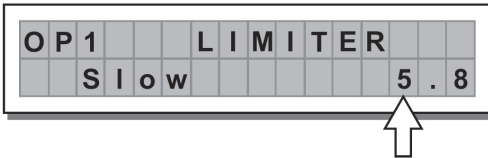

IMPORTANTE! Al activarse el LIMITADOR sobre una salida específica, también cambia la manera en que se muestra el nivel en el correspondiente **LED**. El nivel ya no es el nivel "absoluto" de la salida, sino el nivel de la señal a -24 dB, -12 dB y -6 dB comparado con el **umbral del LIMITADOR** (LED **LIMIT** anaranjado), independientemente del valor del umbral.

MENÚ UTILITY (UTILIDAD) - Permite acceder a las opciones del sistema tales como el control de la tarjeta de memoria multimedia o la protección contra cambios accidentales o no autorizados.

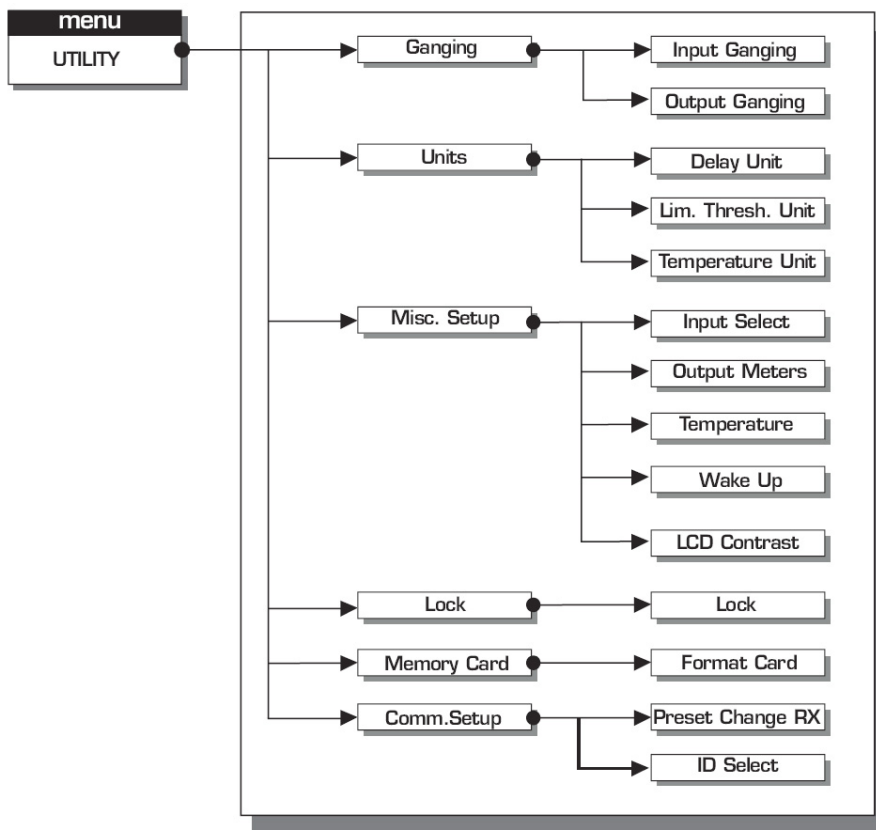

SUBMENÚ GANGING (Agrupamiento) - Le permite agrupar entradas y/o salidas. Por ejemplo, puede usarse para ajustar las secciones derecha e izquierda de una señal estéreo al mismo valor de retardo o ecualización en ambas entradas con una misma operación, o configurar parámetros idénticos de Xover para las diversas salidas aplicadas a un sistema de sonido estéreo. La función Ganging se puede activar separadamente para ambos grupos de entradas y grupos de salidas.

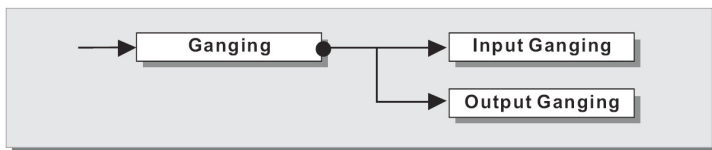

Input Ganging (Agrupamiento de entradas) - Activa y desactiva la función de agrupamiento sobre las entradas. Los parámetros son:

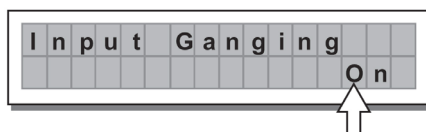
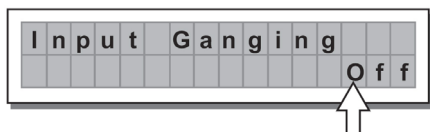

Output Ganging (Agrupamiento de salidas) - Activa y desactiva la función de agrupamiento sobre las salidas.

Los parámetros son:

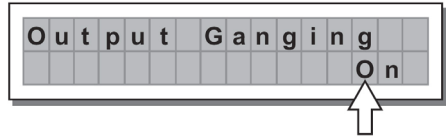
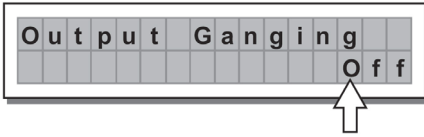

IMPORTANTE:

Tan pronto se agrupan las entradas y/o salidas, las diversas páginas de menú muestran únicamente los valores que se pueden usar realmente.

SUBMENÚ UNITS (Unidades)

Elija las unidades de medida a usar con ciertas funciones.

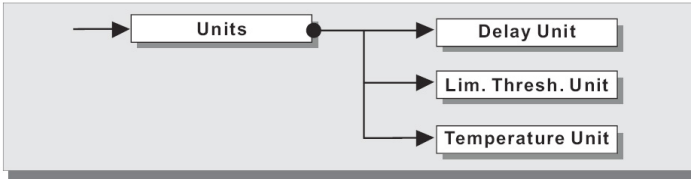

- **Delay Unit** (Unidad de retardo) - Establece la medida en que se expresan los retardos. Las opciones son: **m** = metros - **mm** = milímetros - **ms** = milisegundos - **ms** = microsegundos

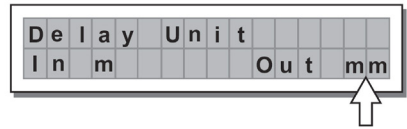
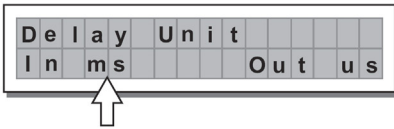

- **Lim. Thresh. Unit** (Unidad del umbral del limitador) - Establece las unidades de medida para el umbral del limitador (menú **EDIT** - Limitador **Output** [Salida]).

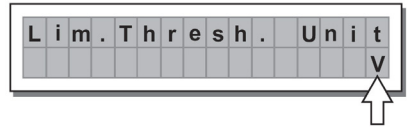
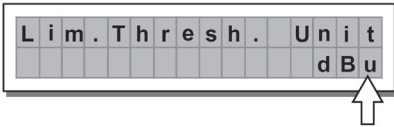

Las opciones son: **dBu** = decibel (0 dBu = 0.775 V rms) - **V** = voltios

- **Temperature Unit** (Unidad de temperatura) - Establece las unidades de medida para la función Temperature (Temperatura) (menú **UTILITY** - Submenú Misc Setup [Configuraciones varias]). Las opciones son: **C** = grados centígrados - **F** = grados Fahrenheit

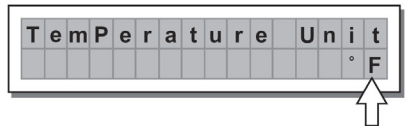
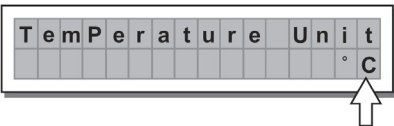

SUBMENÚ MISC. SETUP (Configuraciones varias) - Establece una serie de opciones del sistema.

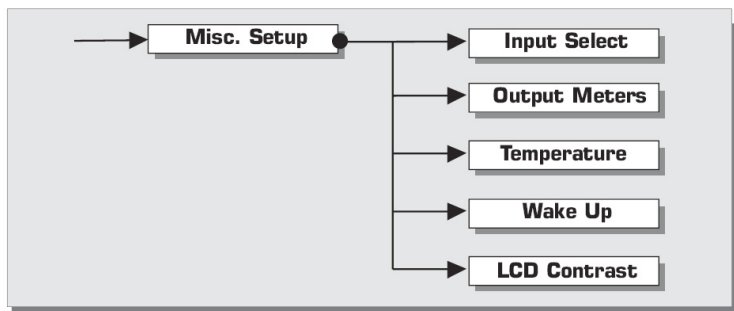

- **Input Select** (Selección de entradas) - Permite seleccionar las entradas que usa el STAGEDRIVE+, digitales o analógicas.



- **Output Meters** (Medidores de salida) - Permite elegir mostrar la señal de salida antes o después del SILENCIAMIENTO.

Las opciones son:

PreMute (Previo al silenciamiento) - la señal se muestra siempre, independientemente del estado de SILENCIAMIENTO

PostMute (Post silenciamiento) - la señal sólo se muestra si la salida no está en MUTE

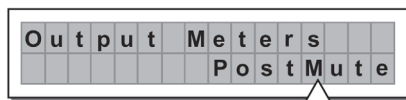

- **Temperature** (Temperatura) - Establece el valor de la temperatura ambiental en el lugar de instalación, para compensar las diferencias debidas a la velocidad variable de la transmisión del sonido debida a la temperatura del aire. Los valores de edición están dentro de los rangos siguientes: **+60 C ~ -30 C** con pasos de 1 C **140.0 F ~ -22.0 F** con pasos de 1.8 F

Nota: Las unidades de medida se pueden elegir entre C (grados centígrados) y F (grados Fahrenheit) por medio de la función Temperature Unit (menú UTILITY - submenú Units).



- **Wake Up** (Activación) - Configura el modo en que las funciones de SILENCIAMIENTO se restauran cuando se enciende el STAGEDRIVE+.

Las opciones son:

Normal - Cuando se enciende, el sistema restaura la última configuración de MUTE (Silenciamiento) existente antes de apagarlo

Mute - Cuando se enciende, el sistema configura automáticamente todas las salidas como SILENCIADAS

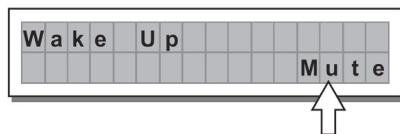
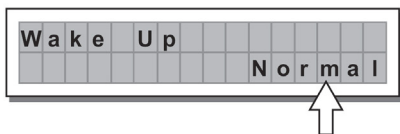

LCD Contrast (Contraste de la LCD) - Ajusta el contraste de la pantalla.

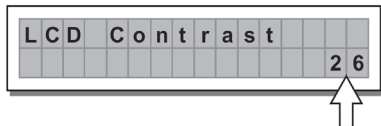

SUBMENÚ LOCK (Bloqueo) - Se usa para habilitar o deshabilitar la protección del sistema contra cambios accidentales o no autorizados.

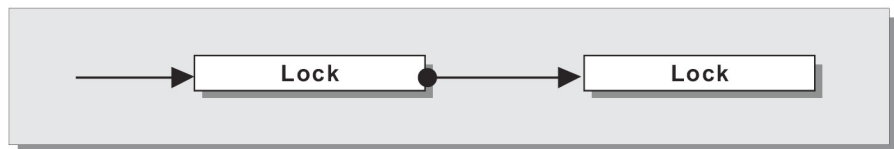

Cómo habilitar la protección

1. Elija un modo de protección (parcial o total)
2. Use las teclas ◀ y ▶ para acceder al área donde se introduce la **contraseña** .
3. La contraseña puede consistir en cuatro caracteres alfanuméricos, obtenibles usando las teclas ◀ y ▶ y editables con el **DIAL**.
4. Después de ingresar la contraseña, pulse **ENTER**.

Nota: Sólo se acepta la confirmación si el cursor se posiciona en uno de los cuatro caracteres de la contraseña. De esta forma Se evita la habilitación accidental de la protección sin haber visto la contraseña.

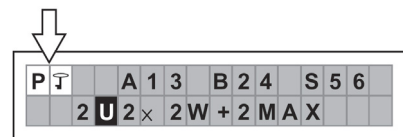
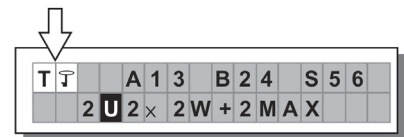
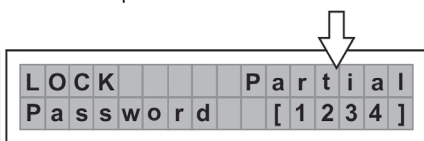
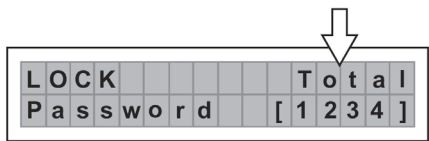

Cómo deshabilitar la protección

1. Acceda al submenú **LOCK** .
2. La pantalla muestra el indicativo para ingresar la contraseña a fin de desbloquear la protección.
3. Ingrese la **contraseña** usando la combinación de las teclas ◀ y ▶ y el **DIAL**, y pulse luego **ENTER**.

Nota: en caso de que la contraseña sea incorrecta, la pantalla la solicita nuevamente, encriptando todos los caracteres.

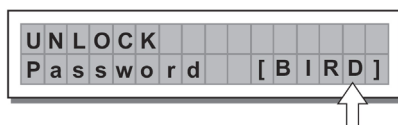
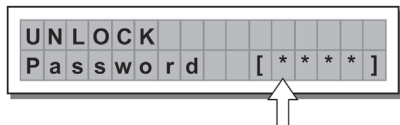

IMPORTANTE! Si se olvidó la contraseña, encienda la unidad mientras pulsa las teclas "PREV" y "◀". De esta forma se desbloquea la protección.

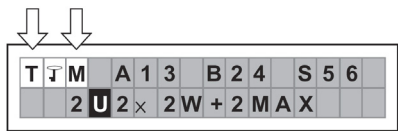

Nota: Junto al símbolo de protección total o parcial, puede aparecer también la letra 'M'. Esto significa que el sistema está protegido, pero el PRESET en cuestión ha sufrido uno o más cambios que aún no se almacenaron. No obstante, es posible encender y apagar el sistema sin problemas, puesto que los valores actuales se mantienen en la memoria tampón. No obstante, si ésta es su configuración primaria, es aconsejable guardarla en un PRESET.

SUBMENÚ MEMORY CARD (Tarjeta de memoria) - Permite formatear (borrar) la tarjeta de memoria multimedia. No se puede usar correctamente una tarjeta en el sistema a menos que se formatee primero en la unidad.

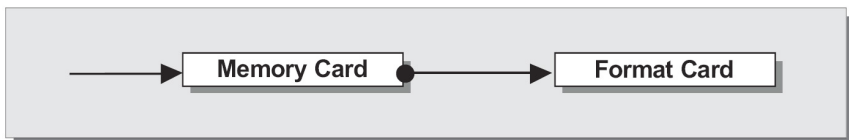

Cómo formatear la tarjeta

1. Inserte una tarjeta de memoria multimedia en la ranura.
2. En el submenú Memory Card, pulse **ENTER**
3. Pulse **ENTER** otra vez para iniciar el formateado.
4. El sistema formatea la unidad hasta que comunica que ha terminado.



Nota: En caso de error o falla de la tarjeta, si no hay ninguna tarjeta en la ranura o si la tarjeta se retira durante el formateado, la pantalla muestra el siguiente mensaje.

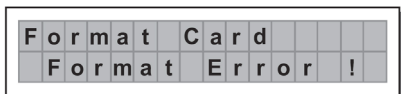

Durante el formateado, el sistema almacena automáticamente el PRESET *Default* (Predeterminado) en las 128 áreas de memoria de la TARJETA.

Nota: puesto que el sistema debe estar siempre configurado, no hay áreas de memoria vacías. Todas las áreas del usuario y de la tarjeta aún no usadas por los datos del usuario almacenados son ocupadas automáticamente por el PRESET *Default*, que contiene una configuración de inicio estándar con todos los valores de los diversos parámetros en cero.

Submenú COMM. SETUP (Configuración de comunicaciones)

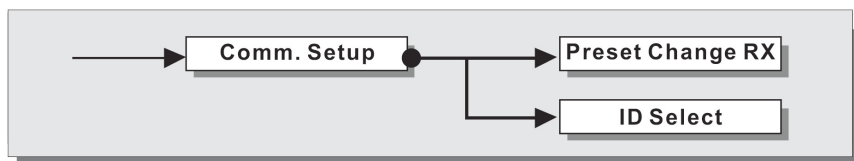

Este submenú permite acceder a la configuración de la comunicación con otras unidades a través de los puertos USB.

Nota: Las funciones Dump Out Preset e Incoming Dump son excepciones, porque se controlan directamente en el menú PRESET.

PRESET Change RX (Receptor de cambios de preset)

Le permite aceptar o ignorar el comando de cambio de preset enviado por el puerto USB de una computadora o por otro STAGEDRIVE+ cuando carga un PRESET. Las configuraciones pueden ser:

- Ignorar los comandos de cambio de preset recibidos.
- Aceptar y ejecutar los comandos de cambio de preset.



INSTALACIÓN DEL DRIVER DE SOFTWARE

1. Inserte el CD de software incluido en la unidad de disco de la computadora.
2. Navegue hasta la carpeta MaxiDrive3.4 DPA software/USB Driver para localizar e instalar el PL-2303 Driver Installer.exe asociado con su versión de Windows.
3. Una vez instalado el driver, encienda el STAGEDRIVE+ y conecte el cable USB desde el puerto USB del STAGEDRIVE + hasta el puerto USB de su computadora.
4. Haga clic derecho en **MY COMPUTER** (Mi PC) y luego en **PROPERTIES** (Propiedades)
5. Haga clic en la pestaña **HARDWARE** y seleccione luego **DEVICE MANAGER** (Administrador de dispositivos)
6. Haga doble clic en **PORTS (COM y LPT)** (Puertos COM y LPT) y busque el puerto **PROLIFIC USB-to-SERIAL Com**
7. Haga doble clic en el puerto **PROLIFIC USB-to-SERIAL Com**, luego haga clic en **PORT SETTINGS** (Parámetros del puerto) y luego en **ADVANCED** (Avanzados)
8. Cambie el **COM PORT NUMBER** (Número de puerto COM) a **COM1** (o cualquier otro número de puerto que no se use) y haga clic en Ok (Aceptar).

CONFIGURACIÓN DEL SOFTWARE

El editor de software se puede configurar como se indica a continuación:

1. Una vez instalado el driver de software (con el STAGEDRIVE+ encendido y conectado a la computadora por USB), abra el programa editor de software.
2. Seleccione **New** (Nuevo)

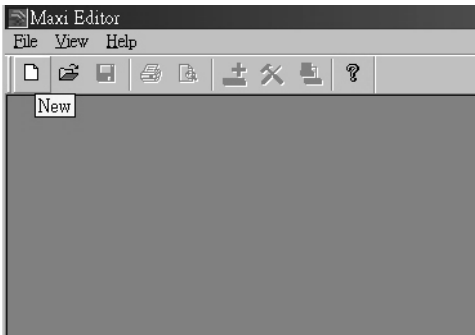

3. Seleccione su interface en la lista.

4. Seleccione **Network Scan** (Exploración de la red)

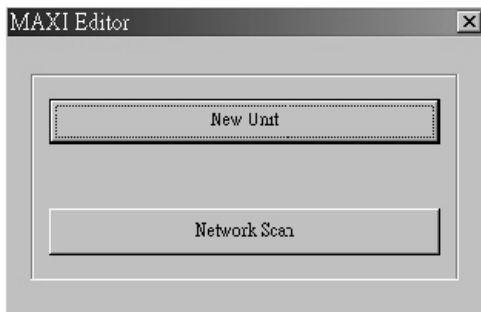

5. Si falla la exploración de la red, verifique el **Device ID number** (Número de identificación de dispositivo). Seleccione **New Unit** (Nueva unidad), seleccionando la interfaz. Asegúrese de que el número de identificación de STAGEDRIVE+ sea 1 o coincida con el número de identificación de dispositivo.
6. Seleccione **OK**, ingresando a la siguiente interfaz:

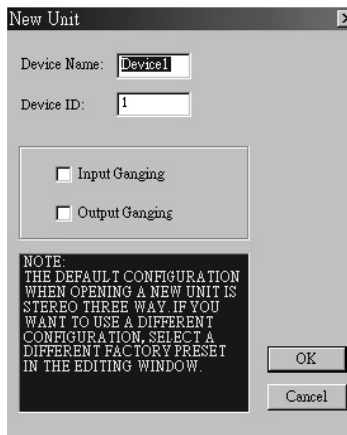

7. Seleccione el icono **Options** (de opciones), ingresando a la siguiente interfaz:



8. Seleccione **Rs232** con la configuración de COM que eligió durante la instalación del driver de software para el puerto y 38400 (o 19200) para la velocidad en baudios.

NOTA: Asegúrese de que los valores de parámetros de la computadora coincidan con lo que se configuró en el STAGEDRIVE+.

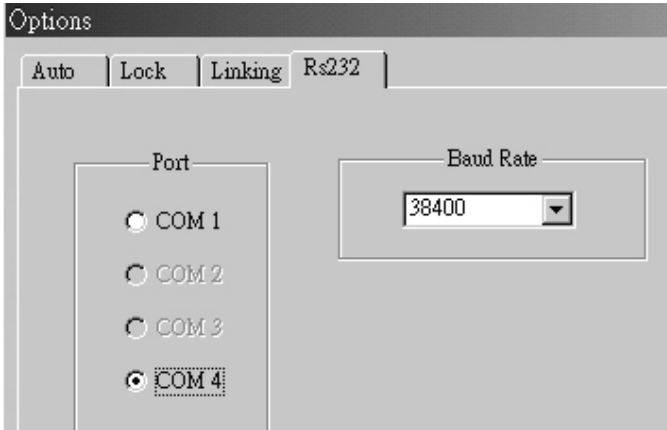

9. Seleccione la línea **On/Off** (Sí/No) en la interfaz principal después de seleccionar **OK**.

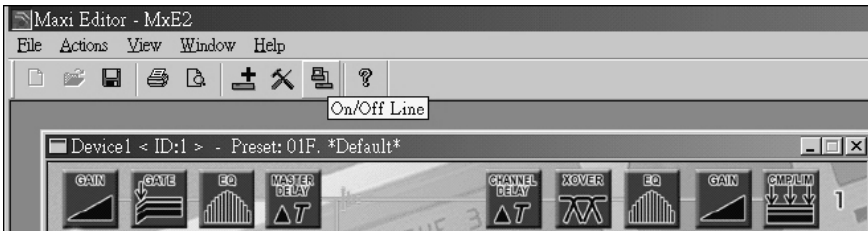

10. Aparece la interfaz. Seleccione **OK** para enlazarse con el equipo.

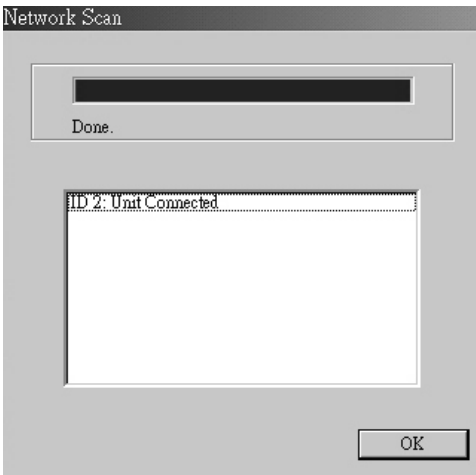

11. Cuando se conecta el enlace, aparece ONLINE.



EJEMPLOS DE CONEXIÓN

Los siguientes ejemplos le ayudarán a conectar y usar el STAGEDRIVE+.
A13 B24 S56 - ESTÉREO DE 2 VÍAS+2 MONO AUX [2 2 W+2 MÁX]

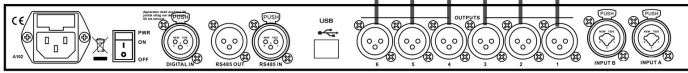
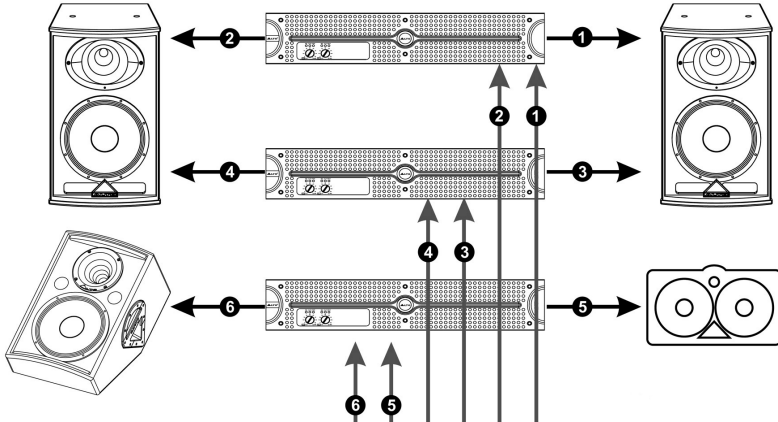
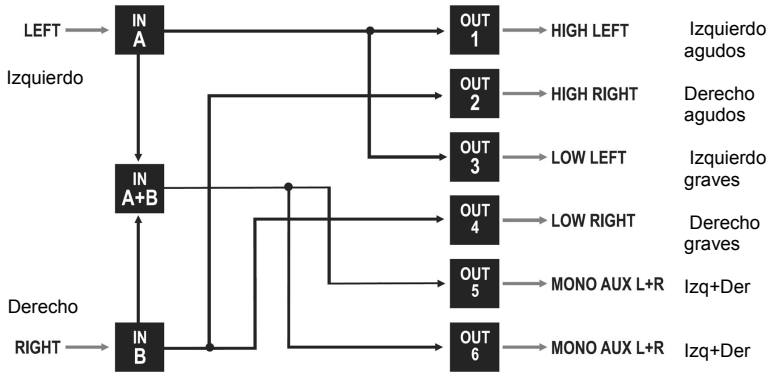

STAGEDRIVE+



Señal
Alimentación

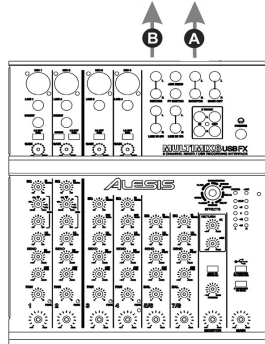

A135 B246 - ESTÉREO DE 3 VÍAS [2X3 W]

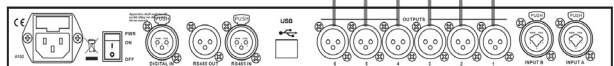
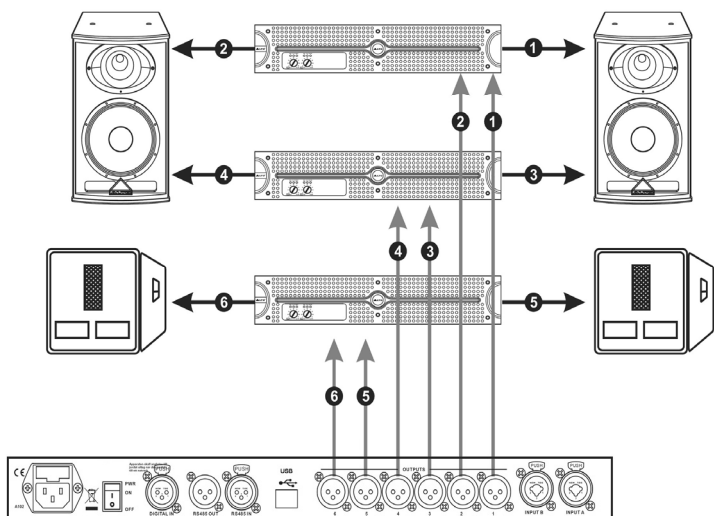
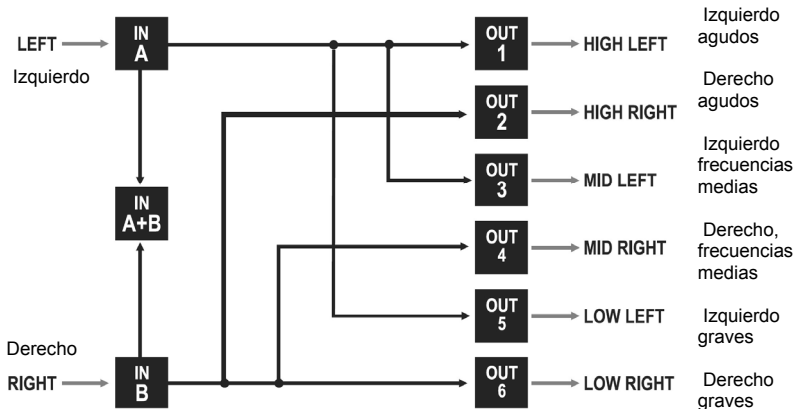

STAGEDRIVE+



Señal

Alimentación

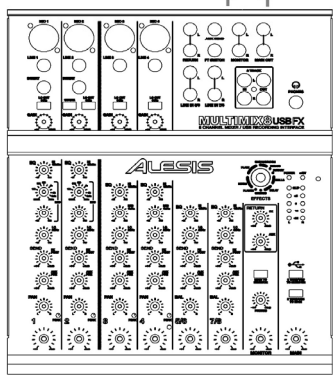

A13 B24 S56 - ESTÉREO DE 3 VÍAS con MONO SUB+MONO AUX [2 3 W+MSB+MÁX]

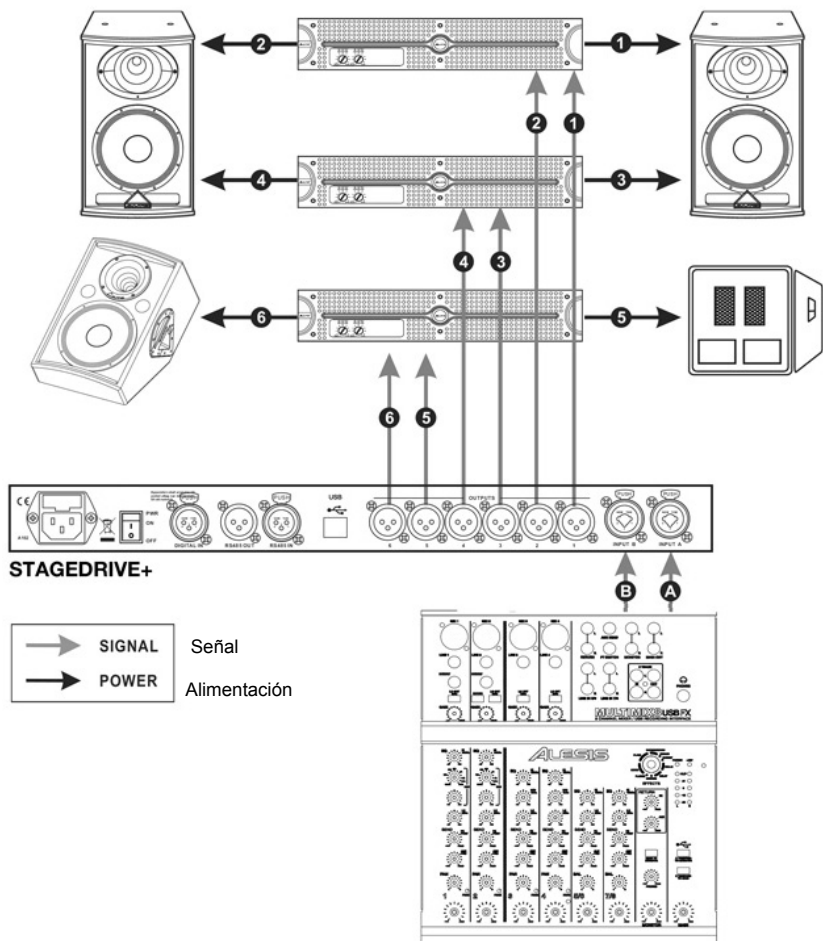

A1324 S56 - MONO 4 DE 4 VÍAS + 2 MONO AUX [4 W+2 MÁX]

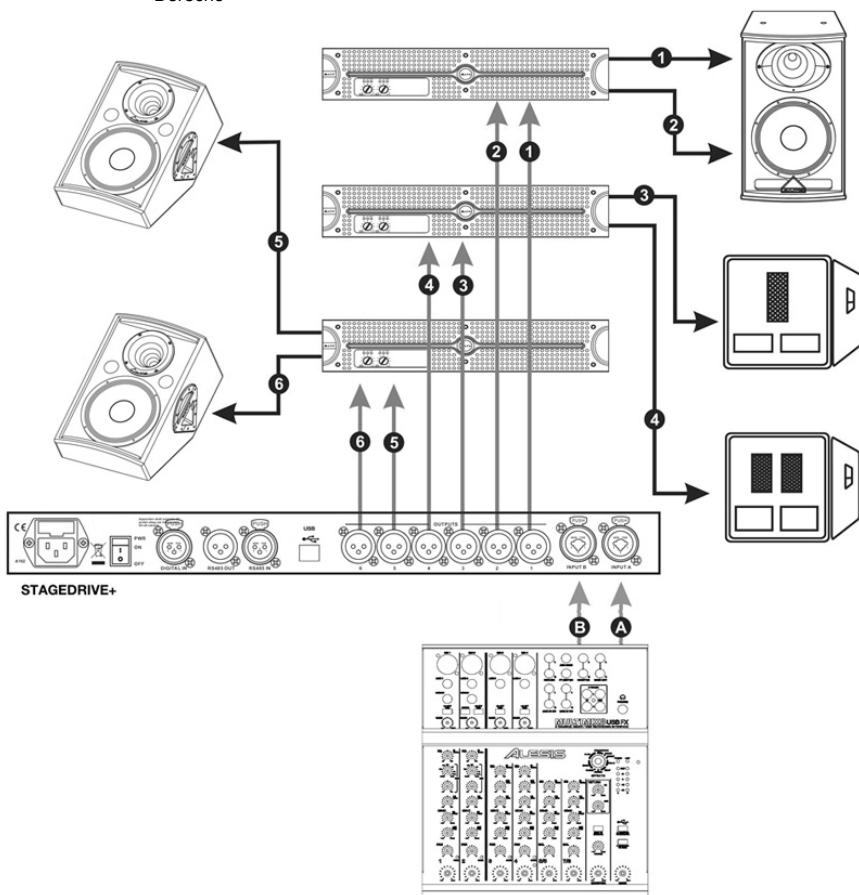
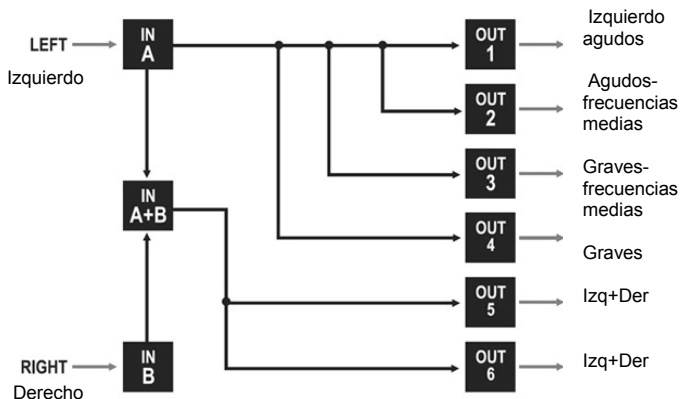

A135 B246 - ESTÉREO DE 3 VÍAS [2x2 W]

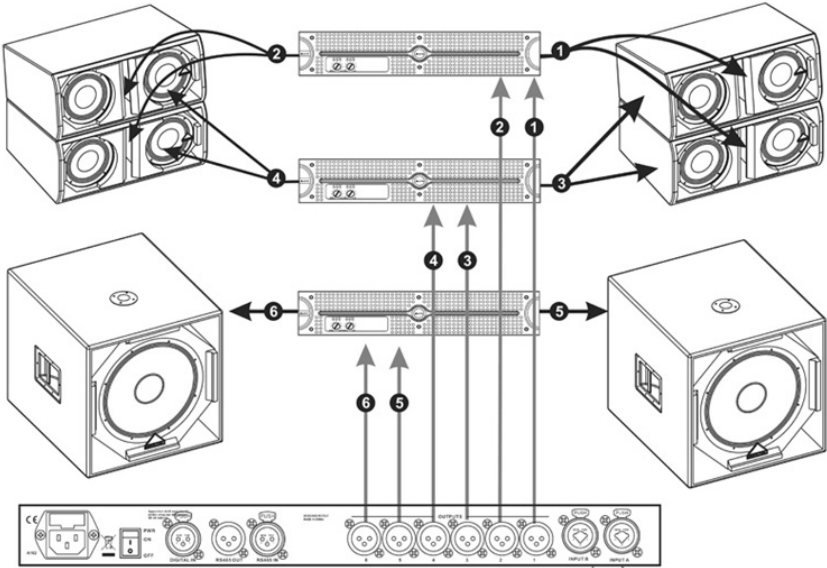
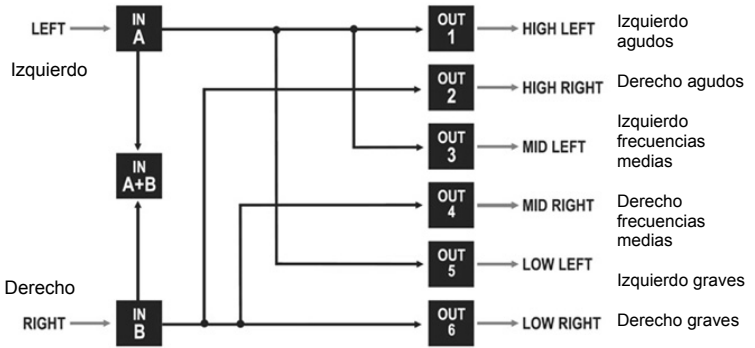

STAGEDRIVE+

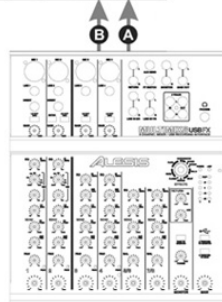

GUIDE D'UTILISATION SIMPLIFIÉ (FRANÇAIS)

CONTENU DE LA BOÎTE

- STAGEDRIVE+
- Câble d'alimentation
- CD logiciel
- Guide d'utilisation simplifié
- Livret des consignes de sécurité et des informations concernant la garantie

INSTALLATION

1. Assurez-vous que tous les articles énumérés dans le contenu de la boîte de ce guide sont inclus dans la boîte.
2. **VEUILLEZ LIRE LE LIVRET DES CONSIGNES DE SÉCURITÉ ET DES INFORMATIONS SUR LA GARANTIE AVANT D'UTILISER LE PRODUIT.**
3. Examinez le schéma de connexion de ce guide.
4. Placez tous les appareils en position de fonctionnement.
5. Assurez-vous que tous les appareils sont hors tension et que tous les atténuateurs et le gain sont réglés à « zéro ».
6. Branchez toutes les sorties des sources audio aux entrées de l'amplificateur tel qu'indiqué sur le schéma.
7. Branchez les sorties de l'amplificateur aux haut-parleurs.
8. Branchez l'amplificateur dans une prise d'alimentation adéquate.
9. Mettez tous les appareils sous tension dans l'ordre suivant :
 - Sources audio (p. ex., microphone, platines tourne-disque, lecteurs de disques compacts, etc.)
 - Console de mixage
 - Amplificateur
 - Haut-parleurs
10. Pour mettre hors tension, toujours inversez l'opération de la façon suivante :
 - Haut-parleurs
 - Amplificateur
 - Console de mixage
 - Sources audio

SCHÉMA DU PANNEAU AVANT

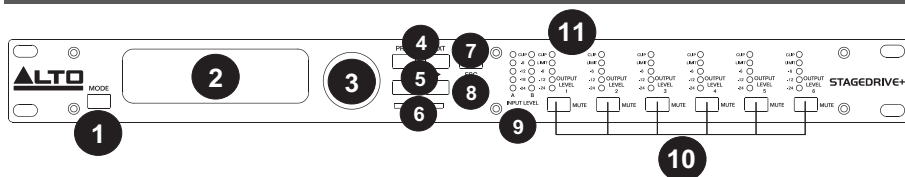

1. **TOUCHE MODE** – Sélection d'une des quatre modes : PRESET, DELAY, EDIT et UTILITY.
2. **ÉCRAN D'AFFICHAGE** – Affiche les différentes pages du menu et des paramètres.
3. **MOLETTE** – Modifie la valeur du paramètre sélectionné.
4. **TOUCHES PREV/NEXT** – Ces touches permettent d'accéder aux pages du menu et/ou des paramètres.
5. **TOUCHES DE DÉPLACEMENT** – Ces touches permettent de sélectionner les différents paramètres.
6. **CARTE MÉMOIRE** – Emplacement pour carte MMC pour sauvegarder les paramètres prédéfinis.
7. **TOUCHE ENTER** – Cette touche permet de confirmer l'édition des paramètres.
8. **TOUCHE ESC** – Cette touche permet de quitter la page d'édition sélectionnée ou annuler une modification.
9. **DEL DU NIVEAU D'ENTRÉE (INPUT LEVEL)** – Indique le niveau de l'entrée A/B.
10. **MISE EN SOURDINE** – Ces touches permettent de mettre en sourdine le signal d'entrée correspondant.
11. **DEL DU NIVEAU DE SORTIE** – Ces DEL indiquent le niveau de sortie du signal correspondant.

Remarque : Le limiteur modifie la manière dont le niveau de sortie est affiché sur la DEL correspondante. Le niveau affiché sur le vumètre n'est plus le niveau de sortie « absolu », mais le niveau du signal à -24 dB, -12 dB, -6 dB par rapport au seuil limite (indiqué par la DEL LIMIT orange).

SCHÉMA DU PANNEAU ARRIÈRE

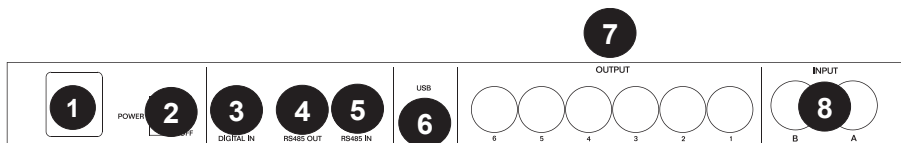

- ENTRÉE D'ALIMENTATION CA** – Branchez le câble d'alimentation inclus à cette entrée.
MISE EN GARDE : Si le fusible doit être remplacé, veuillez contacter un technicien qualifié. Si le fusible continue de sauter après avoir été remplacé, cessez d'utiliser l'appareil et faites-le inspecter par un technicien.
- INTERRUPTEUR D'ALIMENTATION (POWER)** – Cette touche permet de mettre l'appareil sous et hors tension.
- DIGITAL IN** – Branchez un câble XLR-F à cette entrée.
- RS485 OUT** – Cette sortie permet la communication entre plusieurs STAGEDRIVE+.
- RS485 IN** – Cette entrée permet la communication entre plusieurs STAGEDRIVE+.
- PORT USB** – Ce port permet la communication entre un l'appareil et un PC.
- OUPUTS** – Utilisez des câbles XLR-M symétriques avec ces sorties.
- INPUTS** – Prises pour câbles XLR – ¼ po combo.

MISE EN ROUTE

Réglage du signal d'entrée

- Assurez-vous de mettre les sorties du STAGEDRIVE+ en mode **MUTE** (DEL allumées) en appuyant sur chacune des touches MUTE du panneau avant.
- Acheminez un signal dans l'entrée STAGEDRIVE+ tout en contrôlant le vumètre **INPUT LEVEL A-B**.
- Gardez le niveau du signal élevé, sans que la DEL **CLIP** s'allume continuellement, ajustez le gain d'entrée si nécessaire.
- Appuyez sur la touche **MODE** jusqu'à ce que la DEL du menu EDIT s'allume. Utilisez les touches **PREV** et **NEXT** pour accéder à la page Input Gain, puis appuyez sur la touche **ENTER**.
- Utilisez la molette pour changer la valeur du gain et surveillez le niveau du signal sur le vumètre jusqu'à ce que les valeurs idéales sont atteintes.
- Utilisez les touches **PREV** et **NEXT** pour accéder à la page **INB Gain**.

MENUS

Menu PRESET

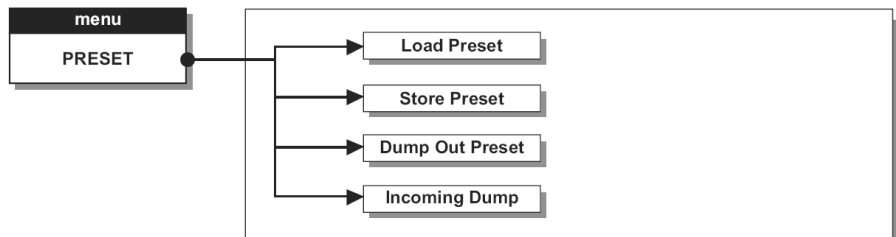

Types de paramètres prédéfinis (PRESETS)

Il y a 3 catégories de paramètres prédéfinis :

- F = Les paramètres prédéfinis d'usine (Factory) qui ne peuvent être changés que temporairement. Ce sont les points de départ pour créer des paramètres prédéfinis utilisateur (User PRESETS) et des paramètres prédéfinis sur la carte mémoire (Card PRESETS).
- U = Les paramètres prédéfinis utilisateur (User PRESETS) peuvent être programmés par les utilisateurs.
- U = Les paramètres prédéfinis sur la carte mémoire (Card PRESETS) peuvent être programmés par les utilisateurs et sauvegardés sur la carte mémoire.

Pour charger un paramètre, prédéfinis :

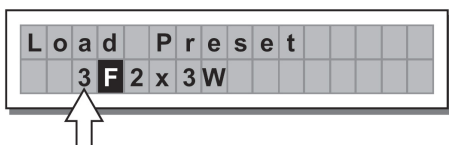

- Utilisez la molette pour sélectionner un paramètre prédéfini d'usine (indiqué par la lettre F) et appuyez sur ENTER pour charger le paramètre en mémoire.

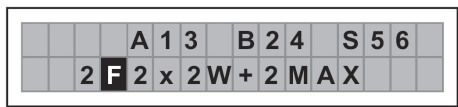

Réglage du gain d'entrée



1. Assurez-vous de mettre les sorties STAGEDRIVE+ en mode MUTE (DEL allumées).
2. Acheminez un signal dans l'entrée STAGEDRIVE+ tout en contrôlant le vumètre.
3. Pour obtenir un bon niveau de signal, assurez-vous que la DEL rouge CLIP du vumètre INPUT LEVEL A-B ne s'allume pas en permanence.
4. Déterminez le paramètre du niveau de sortie pour votre console de mixage (ou autre appareil), puis branchez-le à l'entrée du STAGEDRIVE+.
5. Réglez le gain d'entrée du STAGEDRIVE+ en appuyant sur la touche MODE jusqu'à ce que la DEL du menu EDIT s'allume.
6. Utilisez les touches PREV et NEXT pour accéder à la page Input Gain :
7. Appuyez sur la touche ENTER. L'écran affiche la page IN A Gain ou IN A&B Gain (selon la configuration et les autres paramètres chargés dans la mémoire) :
8. Utilisez la molette pour changer la valeur du gain et surveillez le niveau du signal sur le vumètre jusqu'à ce que les valeurs idéales sont atteintes. Puis utilisez les touches PREV et NEXT pour accéder à la page IN B Gain (s'il y a lieu, selon la configuration et autres paramètres chargés dans la mémoire).

Pour sauvegarder un paramètre, prédéfinis :

1. Utilisez la molette pour sélectionner l'emplacement de sauvegarde et appuyez sur la touche ENTER.
2. Utilisez les touches ◀ et ▶ pour positionner le curseur sur un caractère et utilisez la molette pour entrer la valeur alphanumérique.
3. Modifier le nom du paramètre prédéfini si désiré et appuyez sur la touche ENTER pour sauvegarder les modifications ou appuyez sur la touche ESC pour les annuler.

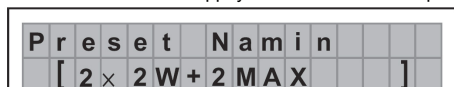

COMM. SETUP – Ce sous-menu permet d'accéder aux configurations de communications pour le transfert d'informations avec d'autres appareils via le port USB. **Remarque** : Les fonctions « Dump Out Preset » (vidage des paramètres prédéfinis) et « Incoming Dump » (vidage entrant) sont une exception, car ils sont contrôlés directement à partir du menu PRESET.

Transmit PRESETS – Utilisez cette page du menu pour transmettre les paramètres prédéfinis via les ports RS485 afin de les copier sur un autre STAGEDRIVE+.

Pour télécharger un paramètre prédéfini – Utilisez la molette pour en sélectionner un, puis appuyez sur la touche ENTER.

Remarque : La page du menu reste inchangée afin de permettre le vidage d'autres pré-réglages. Toutes les données du paramètre prédéfini (nom, configuration, valeurs de paramètres, etc.) sont immédiatement transmises à l'appareil branché au port RS485.

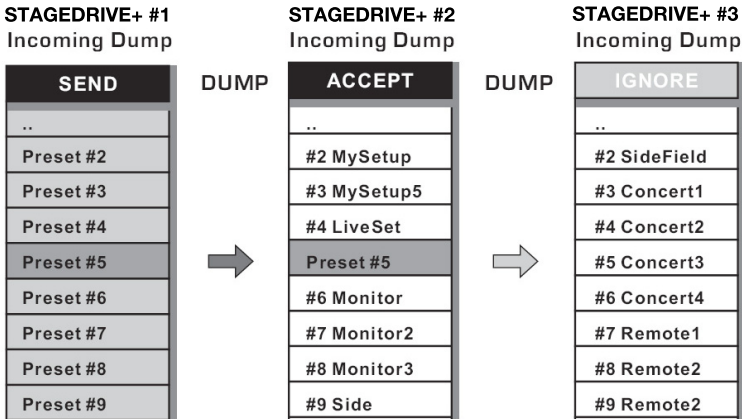

Remarque : Pour que le transfert fonctionne, les appareils qui reçoivent le transfert doivent être capables d'identifier et d'accepter les opérations de vidage entrantes. Lorsque deux ou plusieurs STAGEDRIVE+ sont connectés, le paramètre prédéfini envoyé par le STAGEDRIVE+ écrase le paramètre prédéfini existant dans ce même emplacement mémoire du STAGEDRIVE+ qui reçoit la transmission.

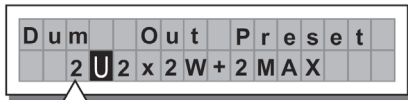

Incoming Dump (vidage entrant)

Accepte ou ignore le vidage d'un paramètre prédéfini envoyé d'un autre STAGEDRIVE+ via le port RS485 ou à partir d'un ordinateur via le port USB. Les configurations des ports permettent :

- d'ignorer les données qui sont envoyées
- d'accepter les données qui sont envoyées

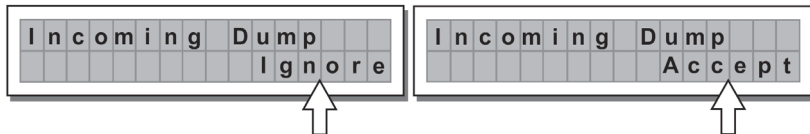

Protection système

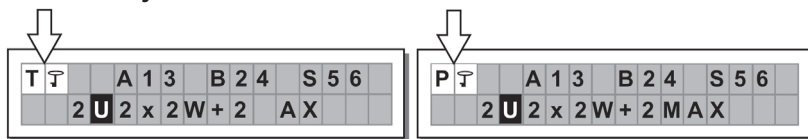

Ces indications apparaissent lorsque la fonction de verrouillage (**LOCK**) est activée (lorsque la fonction de protection (LOCK UTILITY) est entièrement verrouillée (**T**) ou partiellement (**P**) le système est protégé contre toute modification accidentelle ou non autorisée). La fonction de protection est désactivée en entrant un mot de passe, sans quoi aucune modification ne peut être faite.

MENU DELAY

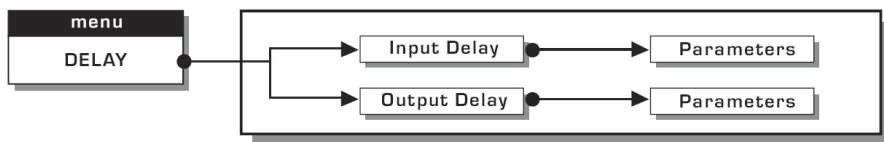

Input Delay (délai d'entrée) : Cette fonction permet de retarder le signal d'une entrée (ou de plusieurs entrées) avant de l'envoyer au système de routage. Toutes les sorties seront retardées par le même laps de temps. Cette fonction est généralement utilisée afin de compenser pour les distances entre les enceintes ou dans de grandes salles.

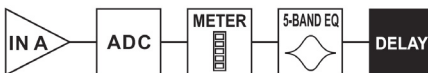
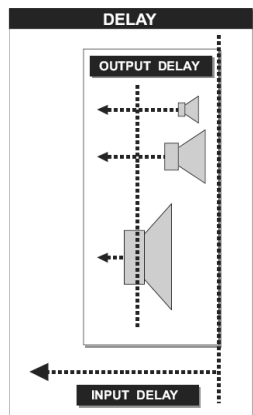

Entrée A ► Convertisseur analogique-numérique ► Vumètre
DEL ► Égalisation 5-bandes ► Delai

Les valeurs de la fonction de délai d'entrée peuvent être réglées selon les pages suivantes :

INPUT DELAY		
unit	range	step
m	0.0 ~ 900.0	0.5
mm	0 ~ 900000	7
ms	0 ~ 2621	1
us	0 ~ 2621438	21

L'unité de mesure peut être sélectionnée avec la fonction Delay Unit (menu UTILITY, sous-menu Units).

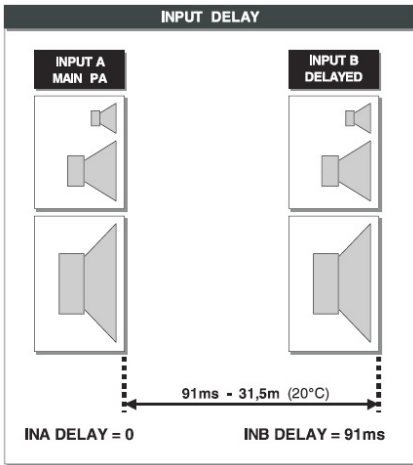

- Output Delay (délai de sortie) : Cette fonction permet de retarder le signal uniquement à partir d'une sortie spécifique. Ceci est utilisé afin de compenser pour la distance entre les différentes enceintes au sein d'un même système de sonorisation (p. ex., un regroupement d'enceintes) ou afin de corriger l'alignement interne des composants des enceintes.

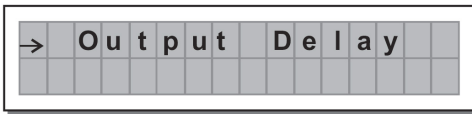

Délai ▶ filtre passe-bas ▶ Filtre passe-haut ▶ Égaliseur 5 bandes ▶ Niveau ▶ Polarité ▶ Limiteur
▶ Vumètre DEL ▶ Mute ▶ Convertisseur analogique-numérique ▶ Sortie



Les valeurs de la fonction de délai de sortie peuvent être réglées selon les pages suivantes :

OUTPUT DELAY		
unit	range	step
m	0.0 ~ 100.0	0.5
mm	0 ~ 100000	7
ms	0 ~ 291	1
us	0 ~ 291271	21

Les valeurs de la fonction de délai de sortie peuvent être réglées selon les pages suivantes :

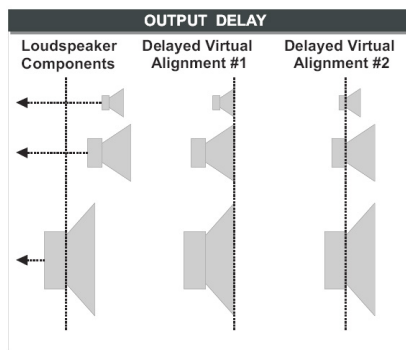
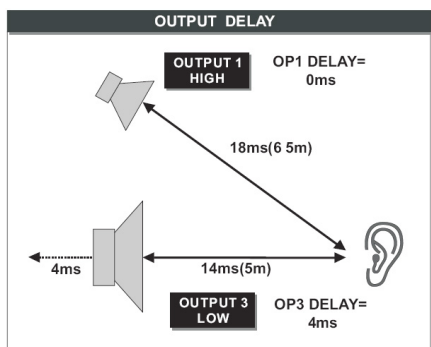

MENU EDIT

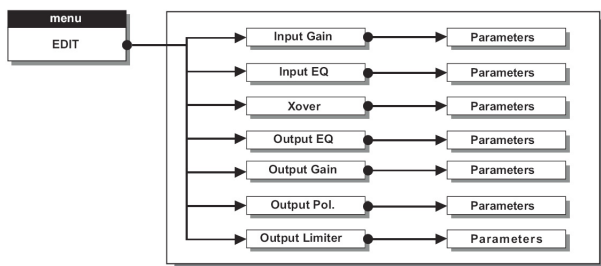

Input Noise Gate (éliminateur de bruit d'entrée) – Cette fonction permet la réduction du bruit de fond généré par un appareil raccordé aux entrées du processeur (p. ex., une console de mixage). Le filtre est actif lorsque le signal d'entrée est en dessous d'un certain seuil et réduit son niveau, coupant les bruits de fond indésirables.

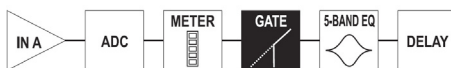

Entrée A ▶ Convertisseur analogique-numérique
 ▶ Vumètre DEL ▶ Éliminateur de bruit ▶ Égalisation 5-
 andes ▶ Délai

Les paramètres suivants peuvent être modifiés, sur deux pages différentes :

a. Noise Gate ON/OFF (active/désactive)

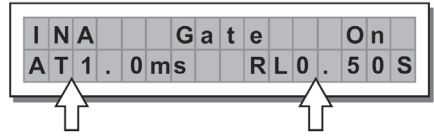
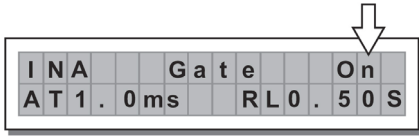

b. Reaction times (temps de réaction) – Définit le temps de réaction et le relâchement du filtre.

- **ATTACK (AT)** : Le temps nécessaire au filtre pour ramener le signal à son niveau normal après que le signal ait atteint le seuil.

- **RELEASE (RL)** : Le temps nécessaire au filtre pour couper le signal après que le signal soit revenu sous le seuil.

Threshold (seuil) – Si le signal passe en dessous du seuil fixé, la fonction Noise Gate réduit le signal. Les valeurs peuvent être réglées selon les plages suivantes : +8 dBu -60 dBu, en incréments de 2 dBu.

Range (Plage) – Définit la quantité de réduction du niveau de signal.

Les valeurs peuvent être réglées selon les plages suivantes : 0 dBu -80 dBu, en incréments variables.

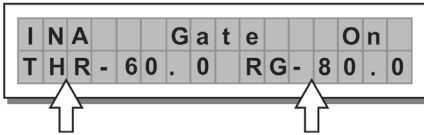

Input/Output EQ (égalisation d'entrée/de sortie) : Égaliseur cinq bandes paramétriques. Vous permet de modifier la tonalité générale du signal.

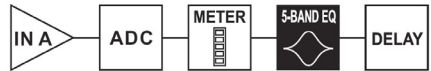

Entrée A ► Convertisseur analogique-numérique
► Vumètre DEL ► Égalisation 5-Bandes ► Delai



Délai ► filtre passe-bas ► Filtre passe-haut ► Égaliseur 5 bandes ► Niveau ► Polarité ► Limiteur
► Vumètre DEL ► Mute ► Convertisseur analogique-numérique ► Sortie

Les paramètres suivants peuvent être modifiés pour chacun des filtres :

- **Type of filter** (type de filtre) – Sélectionnez entre le filtrage Peaking (écrêtage), Low ou High Shelving (en dégradé, bas ou élevé) avec une pente réglable de 6 ou de 12 dB par octave et Notch (à encoche).

I	N	A		E	Q	1		P	e	a	k
2	k	0	0	1	.	0		-	5	.	0

Filtrage par écrêtage
encoche

Filtrage en dégradé bas

Filtrage en dégradé élevé

Filtrage à

Peaking

Low Shelving

High Shelving

Notch

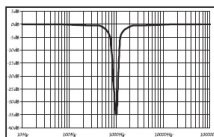
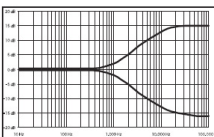
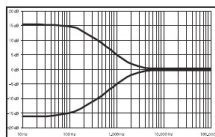
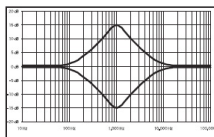

- **Center/Cutoff Frequency** (Fréquence du centre/de coupure) – Sélectionne la fréquence centrale de la courbe du filtrage par écrêtage et à encoche, ou la fréquence de coupure des courbes du filtrage en dégradé.

I	N	A		E	Q	1		P	e	a	k
2	k	0	0	1	.	0		-	5	.	0

- **Bandwidth** (bande passante) – Définit la largeur de la courbe de l'écrêtage et pour le filtrage à encoche. Ceci ne s'applique pas aux courbes du filtrage en dégradé.

I	N	A		E	Q	1		P	e	a	k
2	k	0	0	1	.	0		-	5	.	0

Filtrage par écrêtage

Filtrage à encoche

Peaking

Notch

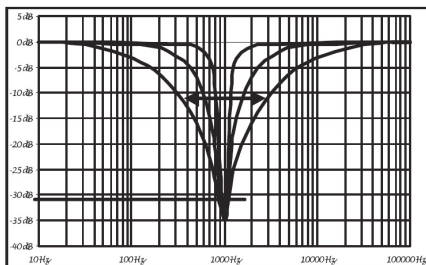
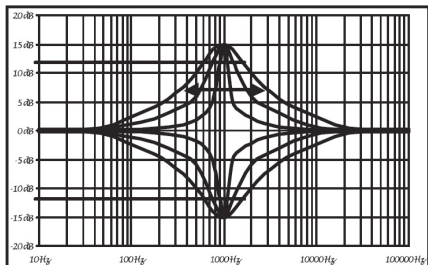

- **Gain** – Permet d'augmenter ou de couper les fréquences sélectionnées. Ceci ne s'applique pas lorsque vous utilisez le filtrage à encoche.

I	N	A		E	Q	1		P	e	a	k
2	k	0	0	1	.	0		-	5	.	0

Filtrage par écrêtage

Peaking

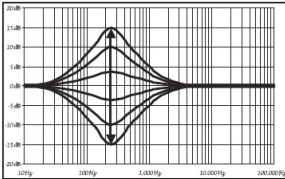

Filtrage en dégradé bas

Low Shelving

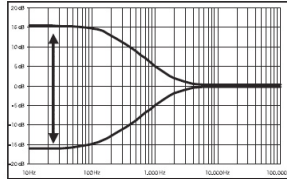

Filtrage en dégradé élevé

High Shelving

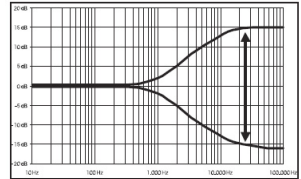

Les valeurs du filtre peuvent être réglées selon les plages suivantes :

5-BAND FULL PARAMETRIC EQ				
NAME	TYPE	GAIN	FREQ	WIDTH
Peak	Peaking	±15dB (step 0,5dB)	15.6Hz ~ 16kHz	0,05 ~ 3,00 oct (step 0,05 oct)
LoSh 6	Low Shelving 6dB/oct			
LoSh 12	Low Shelving 12dB/oct			
HiSh 6	High Shelving 6dB/oct			
HiSh 12	High Shelving 12dB/oct	- 45dB (fix)		0,05 ~ 3,00 oct (step 0,05 oct)
Notch	Notch Filter			

- **Xover** – Filtres passe-bas et filtres passe-haut.



Délai ▶ filtre passe-bas ▶ Filtre passe-haut ▶ Égaliseur 5 bandes ▶ Niveau ▶ Polarité ▶ Limiteur
▶ Vumètre DEL ▶ Mute ▶ Convertisseur analogique-numérique ▶ Sortie

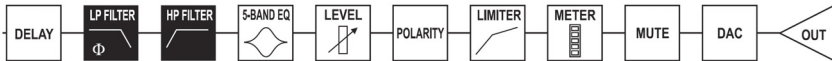

Chaque Xover a 2 pages légèrement différentes (une pour chaque filtre), où le nom de la sortie sur laquelle il agit et le type de filtre indiqué :

- **Low pass Filter** (filtre passe-bas) – Le filtre passe-bas permet à toutes les fréquences inférieures à une plage donnée de passer et coupe toutes les autres fréquences au-dessus.

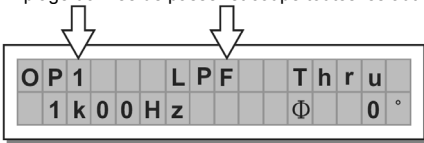

- **High Pass Filter** (filtre passe-haut) – Le filtre passe-haut permet à toutes les fréquences supérieures à une plage donnée de passer et coupe toutes les autres fréquences en dessous.

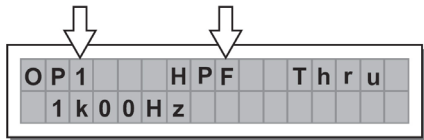

- **Crossover frequency** (fréquence de coupure) – Définit la fréquence de coupure du filtre.

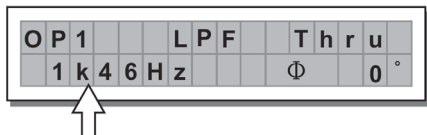

- **Phase** – Ce réglage permet de contrôler de la phase du signal.

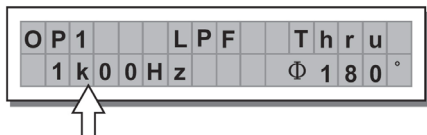

Remarque : Ce réglage est uniquement disponible dans la fenêtre Low-Pass Filter.

Les valeurs pour le Xover peuvent être réglées selon les plages suivantes :

XOVER					
	NAME	TYPE	SLOPE	FREQ	PHASE
LPF	Thru			15.6Hz ~ 16KHz	0° ~ 180° (Stp 5°)
	But	Butterworth	6, 12, 18, 24 dB/oct		
	Bes	Bessel	12, 18, 24 dB/oct		
	LR	Linkwitz-Riley	12, 24, 48 dB/oct		
HPF	Thru			15.6Hz ~ 16KHz	
	Hish 6	Butterworth	6, 12, 18, 24 dB/oct		
	Hish 12	Bessel	12, 18, 24 dB/oct		
	Notch	Linkwitz-Riley	12, 24, 48 dB/oct		

Output Pol – Ce réglage permet de modifier la polarité de la sortie. Vous permet d'inverser la phase du signal des sorties sélectionnées. L'effet fonctionne en 5 étapes dans une plage de 0 et 180. De cette façon, il est possible de régler la phase de chaque sortie en 5 étapes en une révolution complète de 360°. Cette fonction est utile lors de regroupement d'enceintes, pour l'interpolation entre les différentes enceintes ou sections au sein d'un même système de sonorisation.

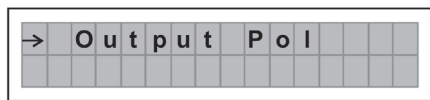

Output Limiter (limiteur de sortie) – Ce réglage permet de maintenir le signal de chaque sortie individuel en dedans d'une plage donnée.

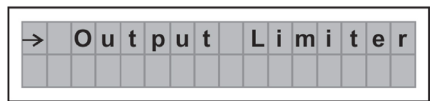

- **Reaction times** (temps de réaction) – Ce réglage permet de sélectionner entre 3 types de temps de réaction du limiteur :
 - Fast** (rapide) – Convient au fonctionnement rapide du limiteur, normalement pour les signaux de fréquences aiguës.
 - Normal** – Convient à la majorité des applications avec des signaux de fréquences moyennes ou aux systèmes avec gamme complète.
 - Slow** (lent) – Convient afin d'éviter les sauts dans le niveau et pour les signaux de basses fréquences.

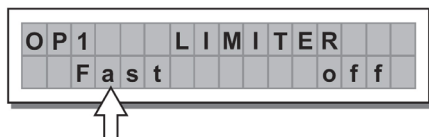

LIMITER	ATTACK	RELEASE
FAST	1 ms	10 ms
NORMAL	8 ms	80 ms
SLOW	45 ms	450 ms

- **Threshold** (seuil) – Définit le niveau au-dessus duquel l'activation du limiteur est déclenchée.

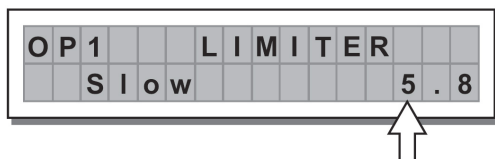

IMPORTANT! L'activation du limiteur sur une sortie modifie également la manière dont le niveau de sortie est affiché sur la DEL correspondante. Le niveau affiché n'est plus le niveau de sortie « absolu », mais le niveau du signal à -24 dB, -12 dB, -6 dB par rapport au seuil limite (indiqué par la DEL LIMIT orange).

MENU UTILITY – Ce menu permet d'accéder aux options système telles que les fonctions en lien avec la sauvegarde sur la carte mémoire et la protection contre les modifications accidentelles ou non autorisées).

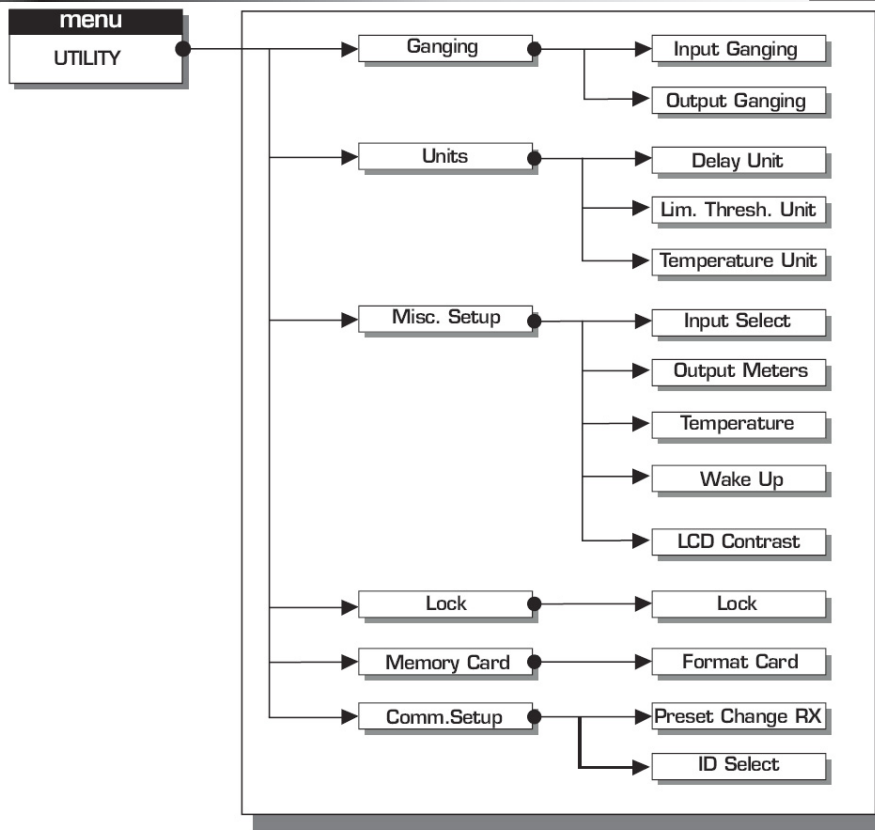

SOUS-MENU GANGING – Vous permet de regrouper des entrées et/ou des sorties. Par exemple, cela peut être utilisé pour ajuster les sections droite et gauche d'un signal stéréo à la même valeur de retard ou d'égalisation en une seule opération, ou pour définir des paramètres Xover identiques pour les différentes sorties acheminées à un système de sonorisation. La fonction Ganging peut être activée séparément pour les groupes d'entrées et de sorties.

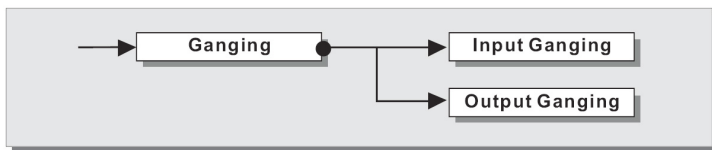

Input Ganging (regroupement d'entrées) – Active/désactive la fonction Ganging sur les entrées. Les paramètres sont :

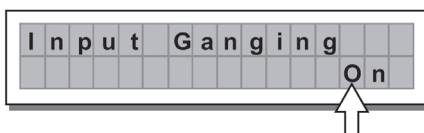
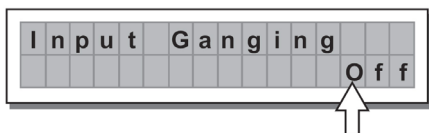

Output Ganging (regroupement de sorties) – Active/désactive la fonction Ganging sur les sorties.
Les paramètres sont :

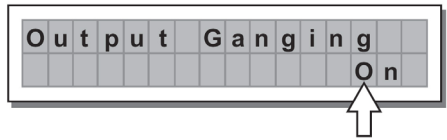
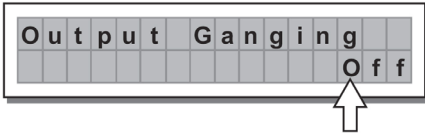

IMPORTANT :

Dès que les entrées et/ou les sorties sont regroupées, les différentes pages du menu n'affichent que les paramètres qui peuvent être modifiés.

SOUS-MENU UNITS

Sélectionnez les unités de mesure à utiliser avec certaines fonctions.

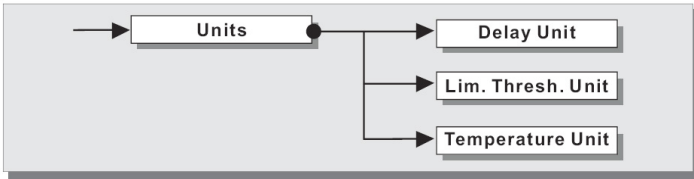

• **Delay Unit** – Définit l'unité de mesure du délai.

Les options comprennent : **m** = mètres – **mm** = millimètres – **ms** = millisecondes – **µs** = microsecondes

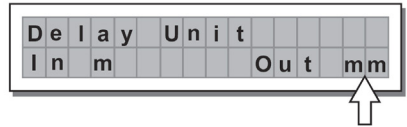
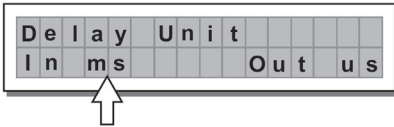

• **Lim. Thresh. Unit** – Définit les unités de mesure pour le seuil du limiteur (menu EDIT – Output Limiter).

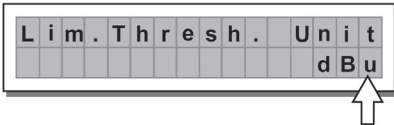

Les options comprennent : **dBu** = décibels (0 dBu = 0,775 V rms) – **V** = volts

• **Temperature Unit** – Définit les unités de mesure pour la fonction de la température (menu UTILITY – sous-menu Misc Setup). Les options comprennent : **C** = degrés centigrades – **F** = degrés Fahrenheit

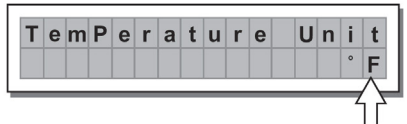
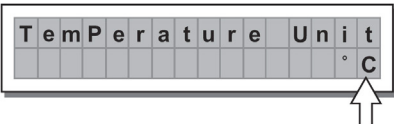

SOUS-MENU MISC. SETUP – Définit une série d'options système.

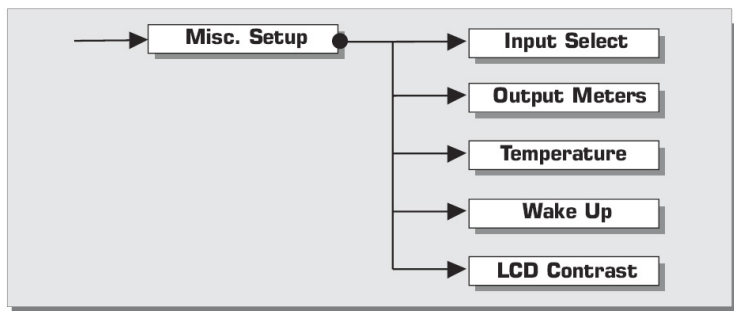

- **Input Select** – Définit les entrées que le STAGEDRIVE+ doit utiliser, numériques ou analogiques.



- **Output Meters** – Définit si le signal de sortie doit être affiché avant ou après avoir été en mode MUTE. Les options comprennent :

PreMute – Le signal est toujours affiché, peu importe qu'il soit en mode MUTE ou pas.
PostMute – Le signal est affiché uniquement si la sortie n'est pas en mode MUTE.

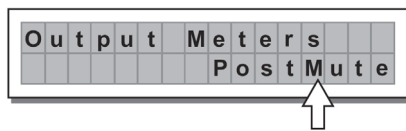
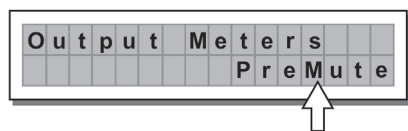

- **Température** – Définit la valeur de la température de l'environnement sur le lieu de l'installation afin de compenser les écarts dus à la vitesse variable de la transmission sonore en raison de la température de l'air. Les valeurs peuvent être réglées selon les plages suivantes : +60 C ~ -30 C en incréments de 1 C 140,0 F ~ -22,0 F en incréments de 1,8 F

Remarque : Les unités de mesure, C (degrés Celsius) et F (degrés Fahrenheit), peuvent être sélectionnées à partir de la fonction de l'unité de température (menu UTILITY – sous-menu Units).

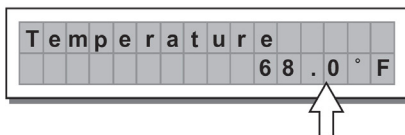
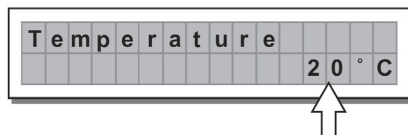

- **Wake Up** – Définit le mode dans lequel les fonctions MUTE sont restaurés lorsque le STAGEDRIVE+ est allumé.

Les options comprennent :

Normal – Lorsqu'il est allumé, le système restaure la dernière configuration MUTE avant de s'éteindre.
Mute – Lorsqu'il est allumé, le système définit automatiquement toutes les sorties en mode MUTE.

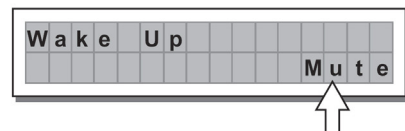
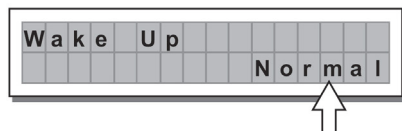

LCD Contrast – Définit le contraste de l'écran.

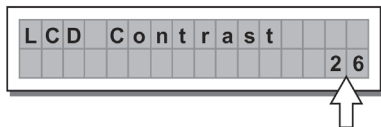

SOUS-MENU LOCK – Ce menu permet d'activer/désactiver la fonction de protection contre les modifications accidentelles ou non autorisées.

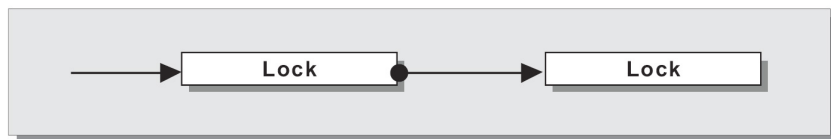

Comment activer la fonction de protection

1. Sélectionnez un mode de protection (partielle ou totale).
2. Utilisez les touches ◀ et ▶ pour accéder au champ dans lequel le **mot de passe** est entré.
3. Le mot de passe peut être composé de quatre caractères alphanumériques, pouvant être obtenus en utilisant les touches ◀ et ▶ et la molette.
4. Après la saisie du mot de passe, appuyez sur la touche **ENTER**.

Remarque : La confirmation n'est acceptée que si le curseur est positionné sur l'un des quatre caractères du mot de passe. Cela empêche l'activation accidentelle de la fonction de protection sans avoir vu le mot de passe.

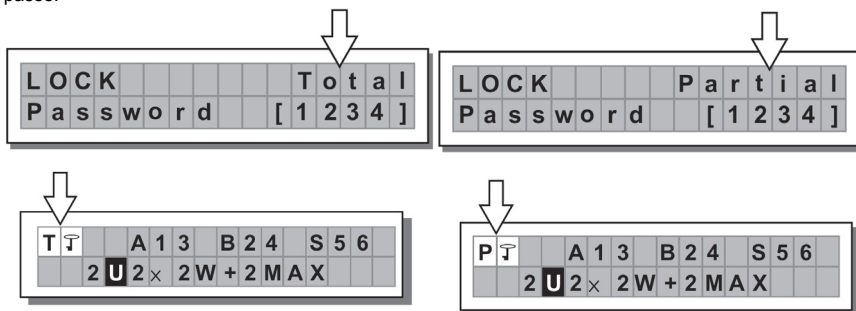

Comment désactiver la fonction de protection

1. Accédez au sous-menu **LOCK**.
2. L'écran affiche l'invite pour la saisie du mot de passe afin de déverrouiller la fonction de protection.
3. Entrez le **mot de passe** en utilisant la combinaison des touches ◀ et ▶ et de molette, puis appuyez sur la touche **ENTER**.

Remarque : Dans le cas où le mot de passe serait incorrectement saisi, l'écran affiche à nouveau l'invite, en chiffrant tous les caractères.

IMPORTANT! Si vous ne vous souvenez pas du mot de passe, allumez l'appareil tout en appuyant sur les touches « **PREV** » et « ◀ ». Maintenant, la fonction de protection est déverrouillée.

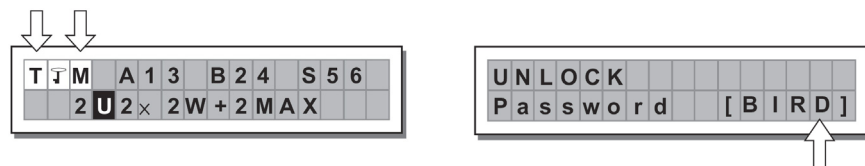

Remarque : Outre le symbole de la protection totale (T) ou partielle (P), la lettre « M » peut également apparaître. Cela signifie que le système est protégé, mais que le paramètre prédéfini en question a subi une ou plusieurs modifications qui n'ont pas encore été enregistrées. Vous pouvez cependant fermer et rouvrir le système sans aucun problème, comme les paramètres actuels seront conservés dans la mémoire tampon. Néanmoins, si cela est votre configuration de base, il est conseillé de la sauvegarder dans un paramètre prédéfini (PRESET).

SOUS-MENU MEMORY CARD – Permet le formatage (effacement) de la carte mémoire. Une carte mémoire ne peut être correctement utilisée par le système à moins qu'elle ait été formatée par l'appareil.

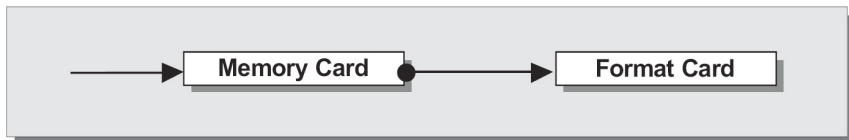

Comment formater la carte

1. Insérer une carte mémoire multimédia dans la fente.
2. Dans le sous-menu Memory Card, appuyez sur la touche **ENTER**.
3. Appuyez de nouveau sur la touche **ENTER** afin de lancer le formatage.
4. Le système formate la carte jusqu'à ce qu'il affiche qu'il a terminé.

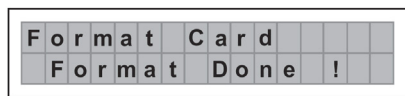
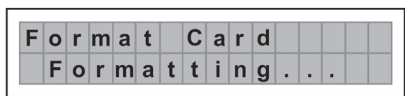

Remarque : Dans le cas d'une erreur ou d'un défaut de carte, s'il n'y a pas de carte dans la fente ou si la carte est retirée pendant le formatage, l'écran affiche le message suivant :

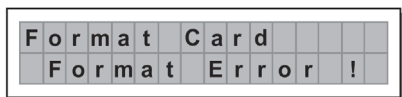

Pendant le formatage, le système enregistre automatiquement le paramètre prédéfini (PRESET) par *défaut* dans tous les 128 emplacements de la carte mémoire.

Remarque : Comme le système doit toujours être configuré, il n'y a pas d'emplacement mémoire vide. Tous les emplacements utilisateur (User) et carte (Card) qui ne sont pas encore utilisés par les données utilisateur sont automatiquement occupés par le paramètre prédéfini par *défaut* (PRESET), qui contient une configuration de départ standard avec toutes les valeurs des différents paramètres à zéro.

SOUS-MENU COMM. SETUP

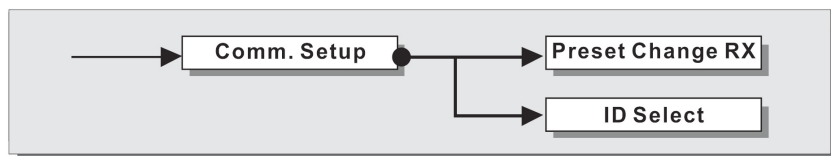

Ce sous-menu permet d'accéder aux configurations de communications pour le transfert d'informations avec d'autres appareils via les ports RS485.

Remarque : Les fonctions « Dump Out Preset » (vidage des paramètres prédéfinis) et « Incoming Dump » (vidage entrant) sont une exception, car elles sont contrôlées directement à partir du menu PRESET.

PRESET Changer RX

Permet d'accepter ou d'ignorer la commande du changement de paramètre prédéfini (PRESET) envoyés via le port USB d'un ordinateur ou d'un autre STAGEDRIVE+ lorsqu'il charge un paramètre prédéfini (PRESET). Les paramètres sont :

- Ignorer les commandes reçues du changement de paramètre prédéfini (PRESET).
- Accepter et exécuter des commandes du changement de paramètre prédéfini (PRESET).



CONFIGURATION DU PILOTE LOGICIEL

1. Insérez le CD d'installation inclus dans le lecteur CD de votre ordinateur.
2. Accédez au dossier MaxiDrive3.4 DPA software/USB Driver afin de trouver et d'installer le fichier PL-2303 Driver Installer.exe associé à la version de Windows appropriée.
3. Une fois le pilote installé, mettez le STAGEDRIVE+ sous tension et connectez le câble USB au port USB du STAGEDRIVE+ au port USB de votre ordinateur.
4. Faites un clic droit sur **POSTE DE TRAVAIL** puis cliquez sur **PROPRIÉTÉS**.
5. Cliquez sur l'onglet **MATÉRIEL**, puis sélectionnez **GESTIONNAIRE DE PÉRIPHÉRIQUES**.
6. Double-cliquez sur **PORTS (COM et LPT)**, et chercher pour le port **PROLIFIC USB-to-SERIAL Com**.
7. Double-cliquez sur **PROLIFIC USB-to-SERIAL Com**, puis cliquez sur **PARAMÈTRES DU PORT** et sur **AVANCÉ**.
8. Changez le **numéro de port COM** à **COM1** (ou à tout autre port COM qui n'est pas utilisé) et cliquez sur OK.

CONFIGURATION LOGICIELLE

Le logiciel d'édition peut être configuré comme ci-dessous :

1. Une fois que le pilote logiciel a été installé (avec le STAGEDRIVE+ sous tension et raccordé à l'ordinateur via USB), lancez le logiciel d'édition.
2. Sélectionnez **New**.

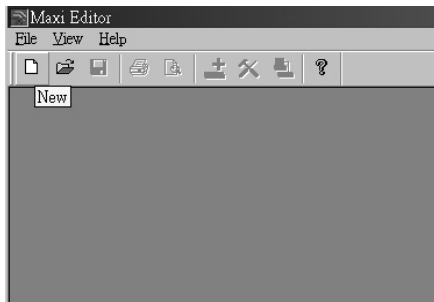

3. Sélectionnez votre interface à partir de la liste.
4. Sélectionnez **Network Scan**.

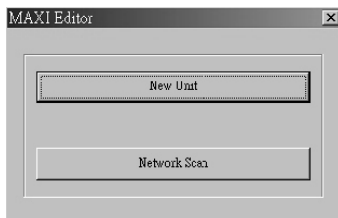

- Si la numérisation du réseau échoue, vérifiez le Device ID number (numéro d'identification du périphérique). Sélectionnez New Unit, puis sélectionnez l'interface. Assurez-vous que le numéro d'identification du STAGEDRIVE+ est 1 ou correspond au numéro d'identification.
- Sélectionnez **OK**, accédant à l'interface suivante :

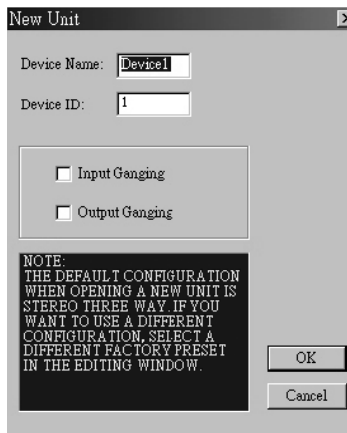

- Sélectionnez **l'icône des options**, accédant à l'interface suivante :



- Sélectionnez **Rs232** avec le paramètre COM que vous avez choisi lors de l'installation du pilote logiciel pour le port et 38400 (ou 19200) pour la vitesse de transmission.

Remarque : Assurez-vous que paramètre sur l'ordinateur correspond au paramètre du STAGEDRIVE+.

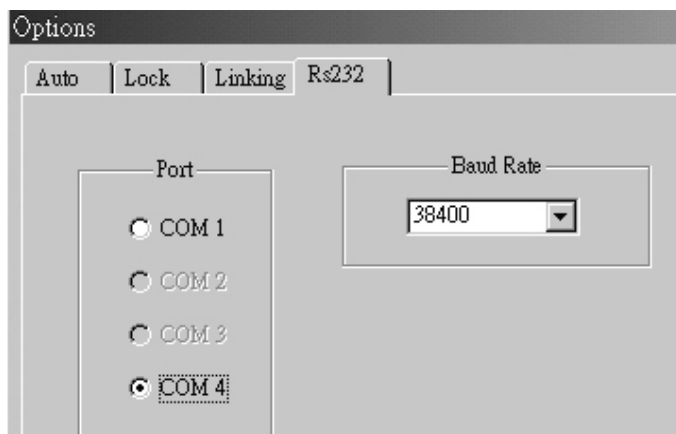

9. Sélectionnez **On/Off Line** sur l'interface principale après avoir sélectionné **OK**.

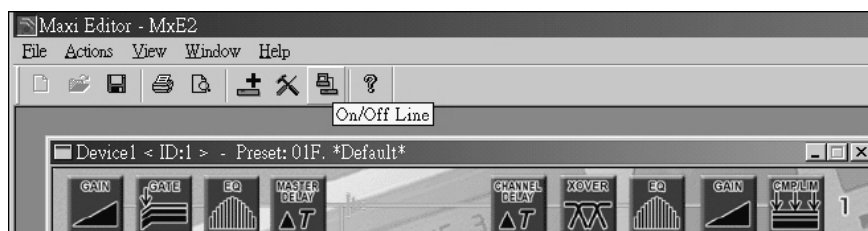

10. L'écran affichera l'interface. Cliquez sur OK, puis il sera relié à l'équipement.



11. Lorsque la liaison est connectée, il affiche ONLINE.



EXEMPLES DE CONNEXIONS

Les exemples suivants vous aideront à brancher et à utiliser le STAGEDRIVE+.
A13 B24 S56 2 VOIES STÉRÉO+2 MONO AUX [2 2W+2MAX]

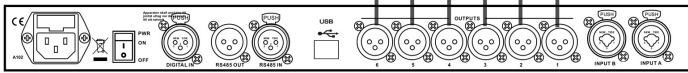
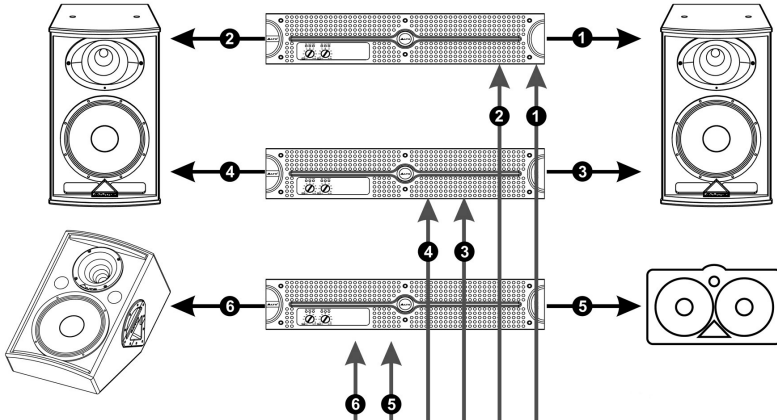
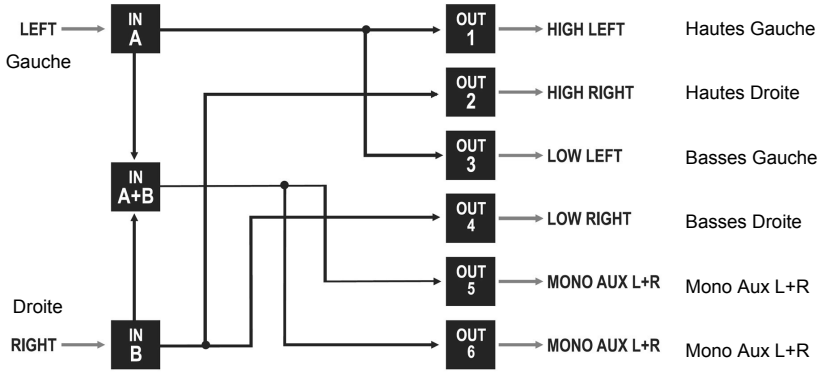

STAGEDRIVE+

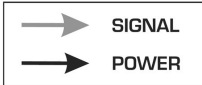

Signal
Alimentation

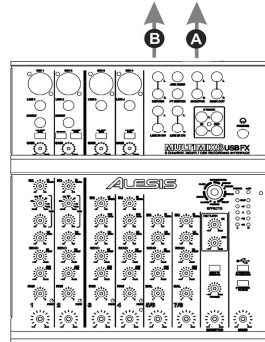

A135 B246 3 VOIES STÉRÉO [2X3W]

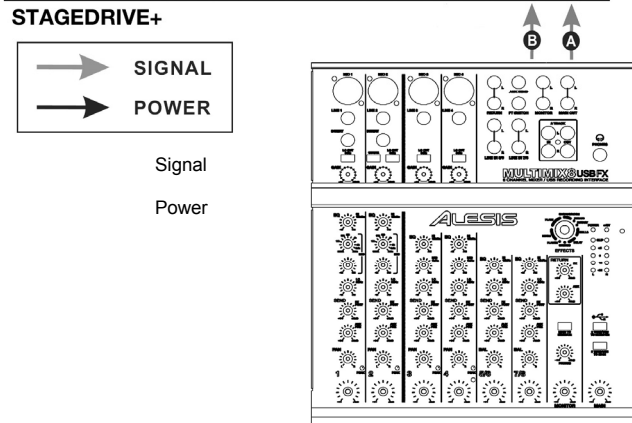
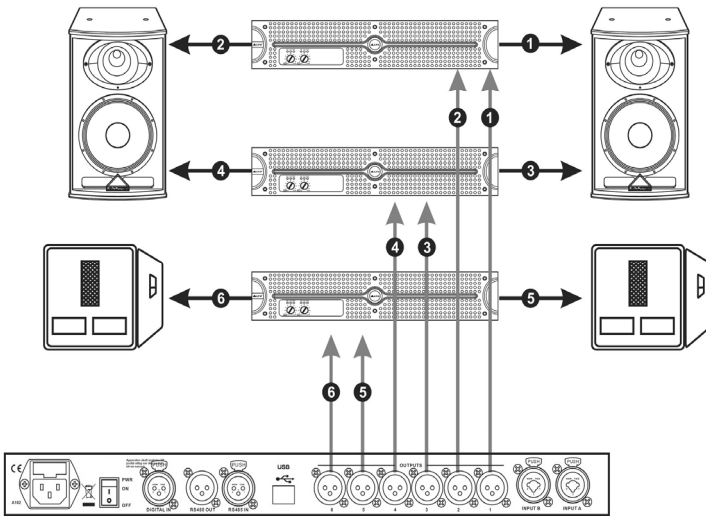
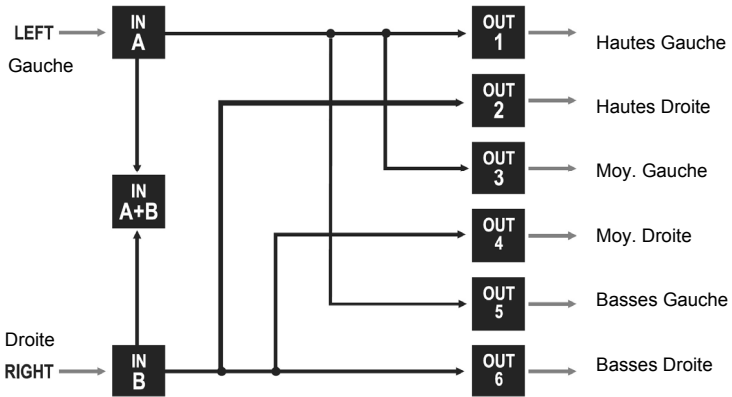

A13 B24 S56 3 VOIES SÉRÉO avec MONO SUB+MONO AUX [2 3W+MSB+MAX]

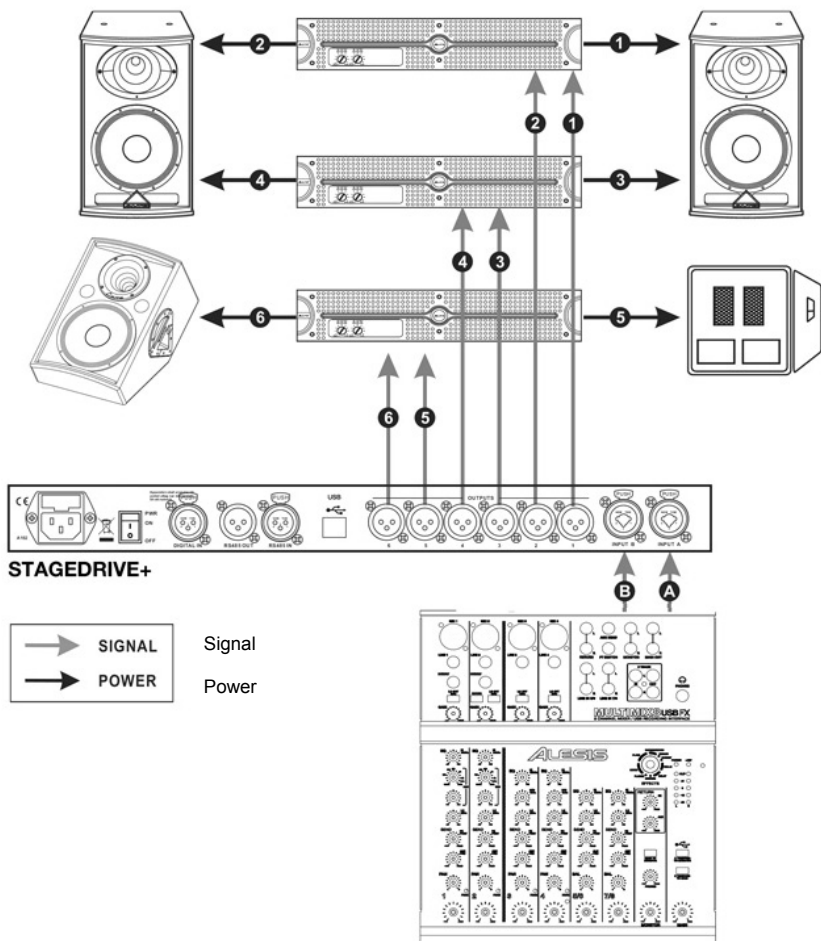

A1324 S56 4 VOIES 4 MONO + 2 MONO AUX [4W+2MAX]

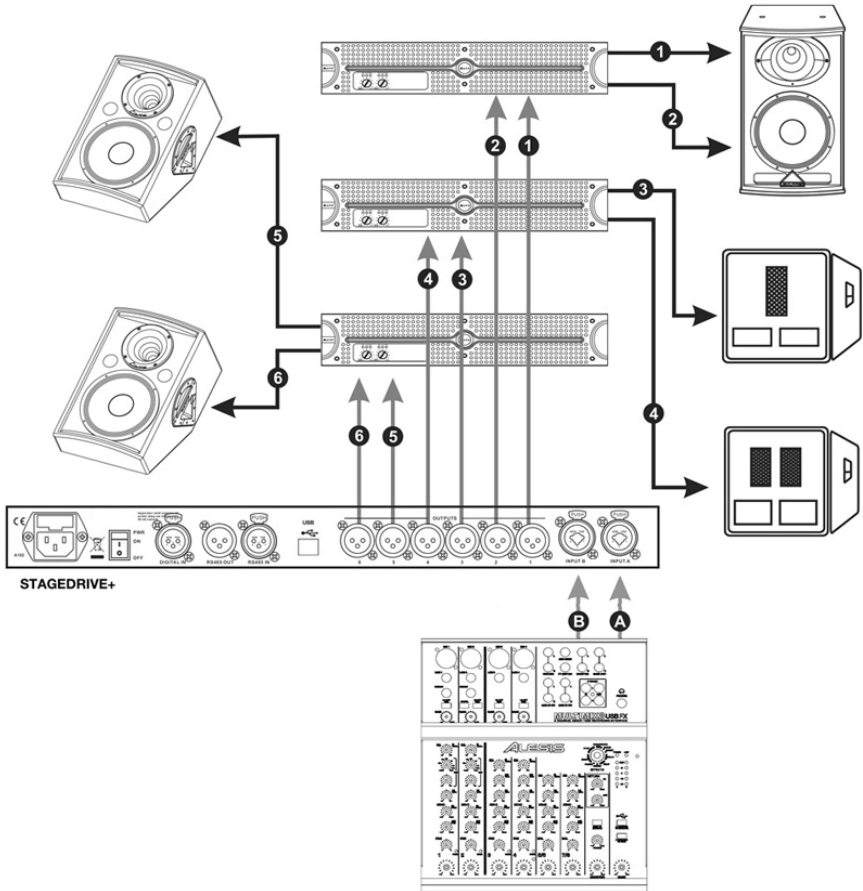
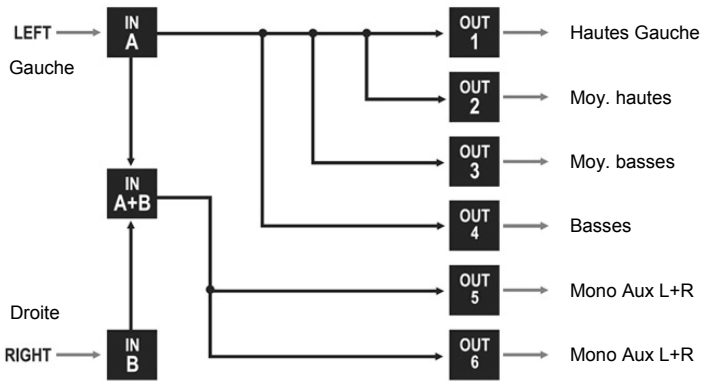

A135 B246 3 VOIES STÉRÉO [2x2W]

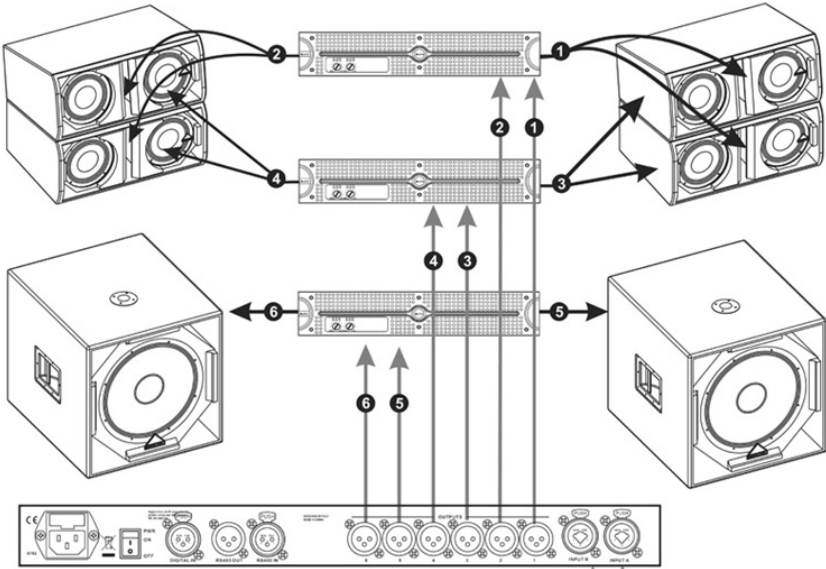
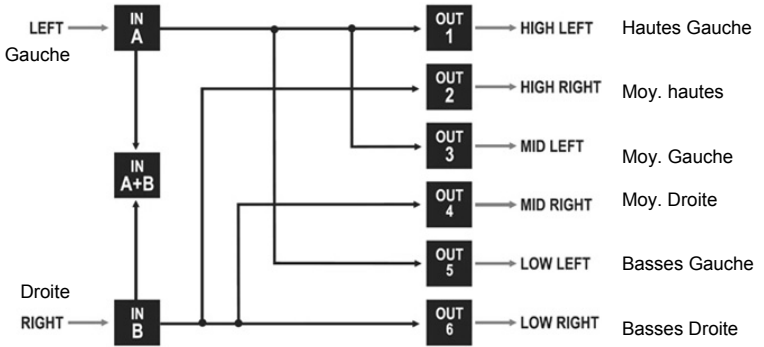

STAGEDRIVE+

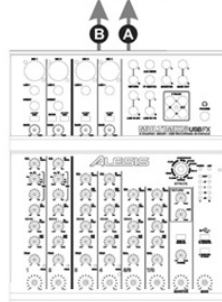

GUIDA RAPIDA (ITALIANO)

CONTENUTI DELLA CONFEZIONE

STAGEDRIVE+
 Cavo di alimentazione
 CD recante il software
 Guida rapida
 Libretto di istruzioni di sicurezza e garanzia

IMPOSTAZIONE RAPIDA

- Assicurarsi che tutti gli elementi elencati nel paragrafo "CONTENUTI DELLA CONFEZIONE" siano contenuti nella confezione stessa.
- LEGGERE ATTENTAMENTE IL LIBRETTO DELLE ISTRUZIONI DI SICUREZZA E GARANZIA PRIMA DI UTILIZZARE IL PRODOTTO.**
- Studiare con cura lo schema dei collegamenti fornito nella guida.
- Collocare tutti i dispositivi in una posizione adeguata all'uso.
- Assicurarsi che tutti i dispositivi siano spenti e che tutti i fader e le manopole di guadagno siano impostati su "zero".
- Collegare tutte le uscite delle fonti audio agli ingressi dell'amplificatore come indicato nello schema.
- Collegare le uscite dell'amplificatore agli altoparlanti.
- Collegare tutti i dispositivi ad un'adeguata fonte di alimentazione.
- Accendere tutto nel seguente ordine:
 - Sorgenti di ingresso audio (microfoni, giradischi, lettori CD, ecc.)
 - Mixer
 - Amplificatori
 - Casse
- Al momento dello spegnimento, spegnere tutto nel seguente ordine:
 - Casse
 - Amplificatori
 - Mixer
 - Fonti audio

SCHEMA PANNELLO ANTERIORE

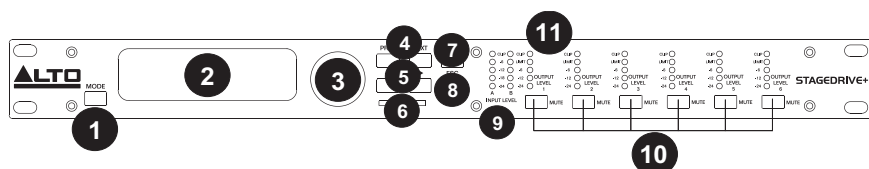

- MODE BUTTON** - Selecting one of four modes: PRESET, DELAY, EDIT and UTILITY.
- DISPLAY** - Mostra le pagine dei vari menu e i relativi parametri.
- MANOPOLA** - Modifica il valore dei parametri selezionati.
- TASTO PREV/NEXT (precedente/successivo)** - Accede alle pagine dei menu e/o ai parametri.
- NAVIGATION CURSOR KEYS** - Seleziona vari parametri.
- SLOT PER SCHEDA DI MEMORIA** - Slot per schede MMC per la memorizzazione di PRESET.
- TASTO ENTER** - Conferma la modifica dei parametri.
- ESC KEY** - Esce dalla pagina di editing selezionata o annulla un'operazione di editing.
- LED LIVELLO DI INGRESSO** - Mostra il livello di ingresso A/B.
- INTERRUTTORI MUTE** - Azzera il segnale proveniente da una qualsiasi delle sei rispettive uscite.
- LED LIVELLO DI USCITA** - Mostrano il livello di uscita.

Nota bene: il LIMITATORE cambierà il modo in cui il livello di uscita è visualizzato a livello del LED corrispondente. Il livello mostrato sul misuratore non è più il livello di uscita "assoluto", bensì il livello del segnale a -24dB, -12dB, -6dB rispetto alla soglia del limitatore (indicata dal LED LIMIT arancione).

SCHEMA DEL PANNELLO POSTERIORE

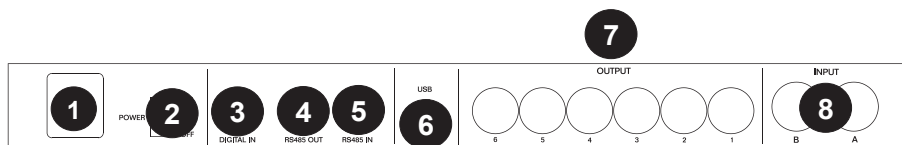

1. **INGRESSO CA E SUPPORTO PER FUSIBILI** - Collegare a questo livello il cavo di alimentazione in dotazione.

ATTENZIONE: se il fusibile deve essere sostituito, rivolgersi ad un tecnico qualificato. Se i fusibili continuano a saltare dopo la sostituzione, interrompere l'uso dell'apparecchio e far riparare il prodotto.

2. **INTERRUTTORE DI ALIMENTAZIONE (POWER)** - Accende e spegne l'alimentazione.
3. **INGRESSO DIGITALE** - Collegare un cavo bilanciato XLR-F a questo livello.
4. **USCITA RS485** - Consente la comunicazione in uscita tra uno STAGEDRIVE+ e un altro STAGEDRIVE+.
5. **INGRESSO RS485** - Consente la comunicazione in ingresso tra uno STAGEDRIVE+ e altre unità STAGEDRIVE+.
6. **PORTA USB** - Consente la comunicazione via PC.
7. **USCITE** - Servirsi di cavi bilanciati XLR-M a livello di queste uscite.
8. **INGRESSI** - Jack bilanciati combinati XLR - 1/4"

PRIMI PASSI

Regolazione del segnale di ingresso

1. Mantenere le uscite dello STAGEDRIVE+ in **MUTE** (LED accesi) premendo ciascun rispettivo tasto Mute sul pannello anteriore.
2. Inviare un segnale nell'ingresso dello STAGEDRIVE+ e osservare il misuratore a LED del **LIVELLO DI INGRESSO A-B**.
3. Mantenere il segnale elevato, ma senza attivare continuamente il LED **CLIP**, regolando il guadagno in ingresso se necessario.
4. Premere il tasto **MODE** fino a quando il LED del menu **EDIT** non si accende. Servirsi dei tasti **PREV** e **NEXT** per recarsi alla pagina **Input Gain** e quindi premere **INVIO**.
5. Servirsi della **MANOPOLA** per cambiare il valore del guadagno gain e osservare il livello del segnale sul misuratore a LED fino a quando non vengono raggiunti i valori ideali.
6. Servirsi dei tasti **PREV** e **NEXT** per accedere alla pagina **INB Gain**.

MENU

Menu PRESET

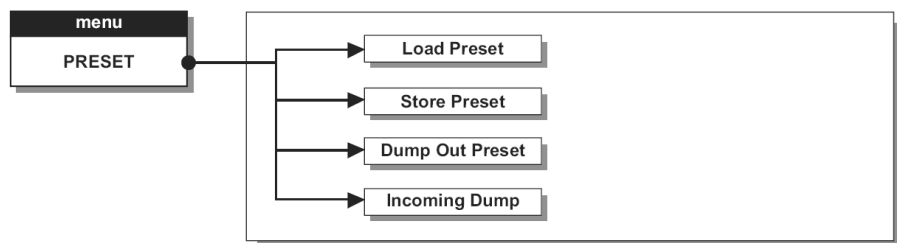

Tipi di PRESET

Vi sono 3 categorie di PRESET:

- **F** = PRESET di fabbrica che non possono essere modificati in via permanente. Questi sono punti di partenza per creare da zero PRESET utente e schede.
- **U** = I PRESET utente possono essere programmati dagli utenti.
- **C** = I PRESET scheda possono essere programmati dagli utenti e memorizzati su una scheda di memoria multimediale.

Per caricare un PRESET:

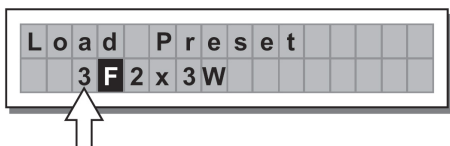

- Servirsi della MANOPOLA per selezionare un PRESET di fabbrica (indicato dalla lettera F) e premere INVIO per caricarlo nella memoria.

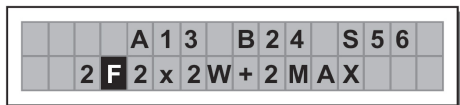

Regolazione del guadagno di ingresso



1. Mantenere le uscite del STAGEDRIVE+ in MUTE (LED accesi).
2. Inviare un segnale all'ingresso del STAGEDRIVE+ e osservare il misuratore a LED.
3. Per ottenere un buon livello di segnale, assicurarsi che il LED rosso INPUT LEVEL A-B CLIP non si accenda ininterrottamente.
4. Trovare il livello di impostazione di uscita adatto al proprio mixer (o altro apparecchio) e collegarlo all'ingresso del STAGEDRIVE+.
5. Regolare il guadagno di ingresso del STAGEDRIVE+ premendo il tasto MODE fino a quando il LED del menu EDIT non si accende.
6. Servirsi dei tasti PREV e NEXT per recarsi alla pagina Input Gain:
7. Premere ENTER. A display comparirà la pagina IN A Gain o la pagina IN A&B Gain (a seconda della configurazione e di altre utilità caricate nella memoria):
8. Servirsi della MANOPOLA per cambiare il valore del guadagno gain e osservare il livello del segnale sul misuratore a LED fino a quando non vengono raggiunti i valori ideali. Quindi servirsi dei tasti PREV e NEXT per accedere alla pagina IN B Gain (se ve ne è una, cosa che dipende dalla configurazione e dalle altre utilità caricate nella memoria).

Per salvare un PRESET:

1. Servirsi della MANOPOLA per selezionare un'area in cui salvare il PRESET e premere INVIO.
2. Servirsi dei tasti ◀ e ▶ per posizionare il cursore su un carattere e servirsi della MANOPOLA per inserire il valore alfanumerico.
3. Modificare il nome del PRESET, se desiderato, e premere INVIO per salvare le modifiche o premere ESC per annullare.

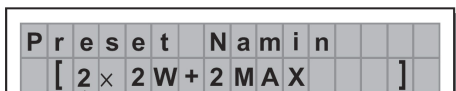

COMM. SETUP SUBMENU - Questo sottomenu consente l'accesso alla configurazione della comunicazione con altri apparecchi tramite la porta USB. **Nota bene:** le funzioni 'Dump Out Preset' e 'Incoming Dump' sono un'eccezione in quanto sono controllate direttamente nel menu PRESET.

Transmit PRESETS (trasmetti preset) - Servirsi di questa pagina del manu per trasmettere i PRESET tramite le porte RS485 per copiare PRESET su un altro STAGEDRIVE+.

Per scaricare un PRESET- Selezionare un PRESET servendosi della MANOPOLA e premere INVIO.

Nota bene: la pagina menu rimane immodificata per consentire di scartare altri PRESET.

Tutti i dati dei Preset (nome, configurazione, valori dei parametri, ecc.) vengono immediatamente trasmessi alle unità collegate alla porta RS485.

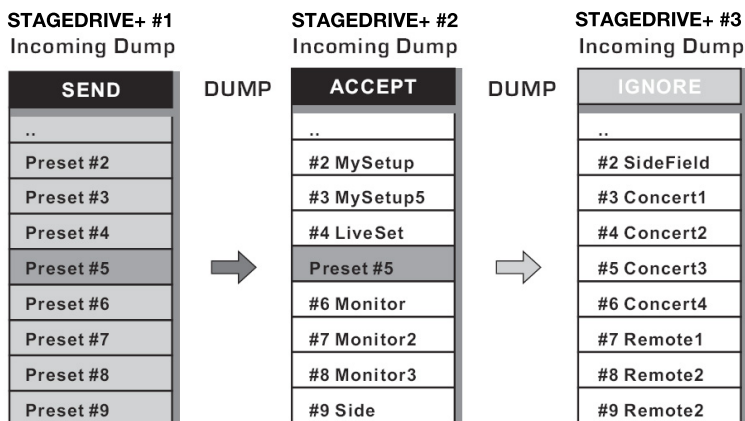

Nota bene: affinché il trasferimento funzioni, le unità riceventi devono essere in grado di identificare e accettare operazioni di scarto in ingresso (Incoming Dump). Quando due o più STAGEDRIVE+ sono collegati, il PRESET in viato dallo STAGEDRIVE+ trasmittente sovrascrive il PRESET esistente nella stessa posizione di memoria dello STAGEDRIVE+ ricevente.

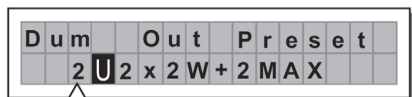

Incoming Dump

Accetta o ignora lo scarto di un PRESET inviato da un altro STAGEDRIVE+ tramite la porta RS485 o da un computer via USB. Le configurazioni delle porte possono essere:

- Ignorare i dati inviati
- Accettare i dati inviati

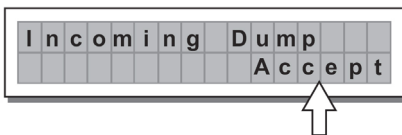
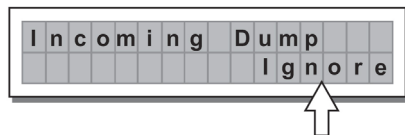

Protezione del sistema

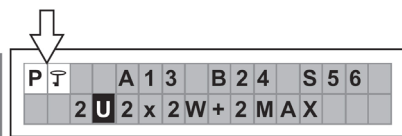
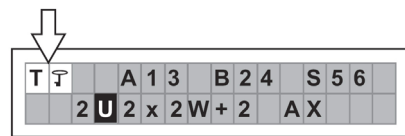

Queste indicazioni compaiono quando la funzione **LOCK** è attivata, (quando il sistema LOCK UTILITY è interamente (T) o parzialmente (P) protetto contro modifiche accidentali o non autorizzate). La protezione è impostata servendosi di una password, senza la quale non è possibile effettuare alcuna modifica.

MENU DELAY

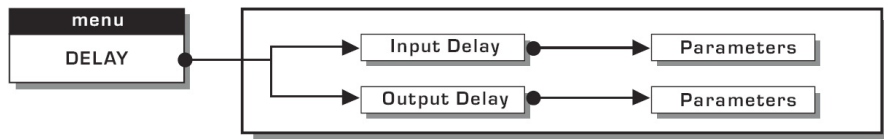

Delay (ritardo) di ingresso: ritarda il segnale di un ingresso (o la somma degli ingressi) prima di inviargli al sistema di convogliamento. Tutte le uscite verranno ritardate della stessa durata di tempo. Questo è comunemente utilizzato per compensare le distanze tra gli alloggiamenti della cassa o grandi arene.

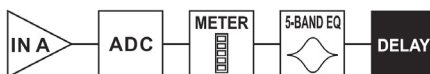
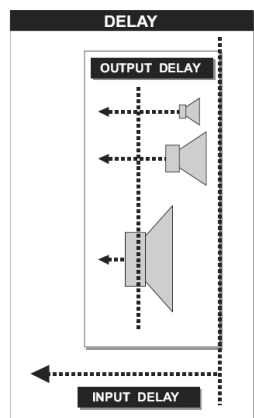

Ingresso A ► Converter da analogico a digitale ► Misuratore a LED ► EQ a 5 bande ► Delay

I valori del Delay di ingresso possono essere configurati nei seguenti intervalli:

INPUT DELAY		
unit	range	step
m	0.0 ~ 900.0	0.5
mm	0 ~ 900000	7
ms	0 ~ 2621	1
us	0 ~ 2621438	21

L'unità di misura può essere scelta con la funzione Delay Unit (ritarda unità) (sottomenu Units del menu UTILITY).

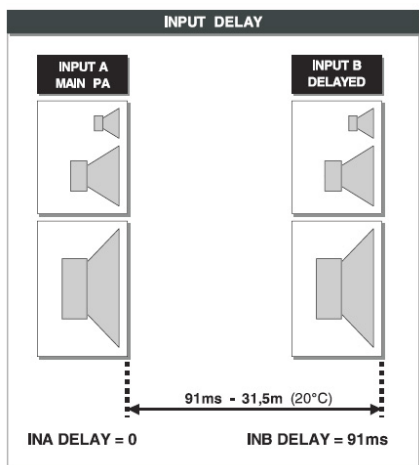

- **Delay (ritardo) di uscita:** ritarda il segnale proveniente unicamente da un'uscita specifica. Viene utilizzato per compensare la distanza tra casse diverse in uno stesso sistema audio (cluster) o per correggere l'allineamento interno di componenti presenti nell'alloggiamento della cassa.

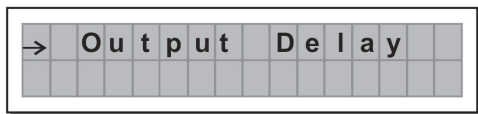

Delay ► Filtro passa basso ► Filtro passa alto ► EQ a 5 bande ► Livello ► Polarità ► Limitatore ► Misuratore a LED ► Mute ► Convertitore da digitale ad analogico ► Uscita

I valori del Delay di uscita possono essere configurati nei seguenti intervalli:

OUTPUT DELAY		
unit	range	step
m	0.0 ~ 100.0	0.5
mm	0 ~ 100000	7
ms	0 ~ 291	1
us	0 ~ 291271	21

I valori del Delay di uscita possono essere configurati nei seguenti intervalli:

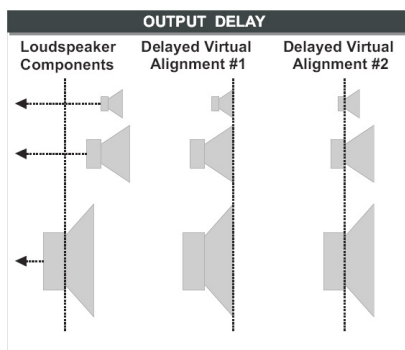
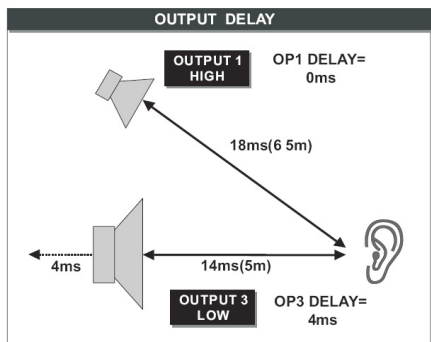

MENU EDIT (modifica)

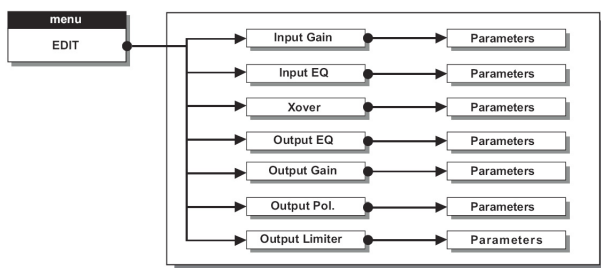

Input Noise Gate - Consente la riduzione del rumore di sottofondo generato da un apparecchio collegato agli ingressi del processore (un mixer, ad esempio). Il filtro è attivo quando il segnale di ingresso è al di sotto di una certa soglia e riduce il suo livello, tagliando i rumori di sottofondo indesiderati.



Ingresso A ► Converter da analogico a digitale ► Misuratore a LED ► Gate ► EQ a 5 bande ► Delay

I seguenti parametri modificabili sono disponibili, in due pagine diverse:

a. Noise Gate ON/OFF

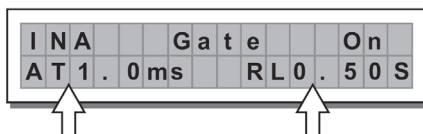
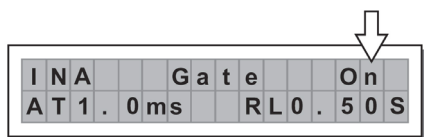

b. Reaction times (tempi di reazione)- Imposta i tempi di attacco e rilascio del Noise Gate.

- **ATTACK (attacco) (AT)**: il tempo necessario al filtro per riportare il segnale al suo livello normale quando supera la soglia.

- **RELEASE (rilascio) (RL)**: il tempo necessario al filtro per tagliare il segnale quando va al di sotto della soglia.

Threshold (soglia) - Se il segnale scende al di sotto del livello di soglia impostato, il Noise Gate riduce il segnale. I valori di modifica rientrano nei seguenti intervalli: +8dBu -60dBu, con passi da 2dBu.

Range (intervallo) - Stabilisce la quantità di riduzione del livello del segnale.

I valori di modifica rientrano nei seguenti intervalli: 0dBu -80dBu, con passi variabili.

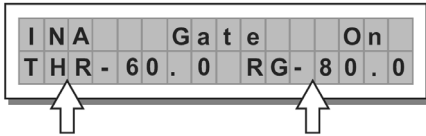

EQ di ingresso/uscita: filtri EQ parametrici a cinque bande. Consente di alterare la tonalità complessiva del segnale.

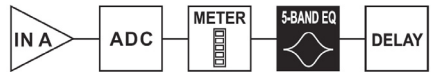

Ingresso A ▶ Converter da analogico a digitale
▶ Misuratore a LED ▶ EQ a 5 bande ▶ Delay



Per ciascun filtro sono disponibili i seguenti parametri modificabili:

- **Tipo di filtro** - Seleziona il filtro per il picco o per le funzioni di shelving basso o alto con una slope di 6 o 12 dB per ottava e filtro Notch.

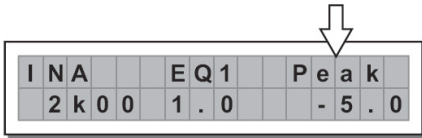

Delay ▶ Filtro passa basso ▶ Filtro passa alto ▶ EQ a 5 bande ▶ Livello ▶ Polarità ▶ Limitatore ▶ Misuratore a LED ▶ Mute ▶ Convertitore da digitale ad analogico ▶ Uscita

Picco

Peaking

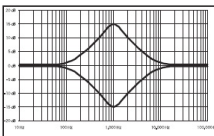

Shelving basso

Low Shelving

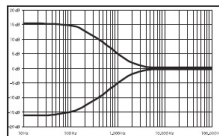

Shelving alto

High Shelving

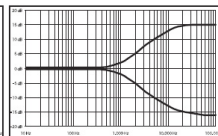

Notch

Notch

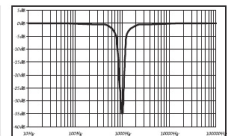

- **Frequenza center/cutoff** - Seleziona la frequenza centrale della curva di picco e del filtro Notch o la frequenza di taglio delle curve di Shelving.

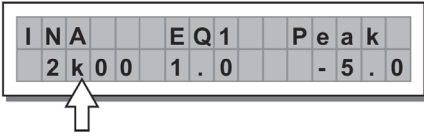

- **Bandwidth (ampiezza di banda)** - Imposta l'ampiezza della curva di picco o notch. Non si applica alle curve di Shelving

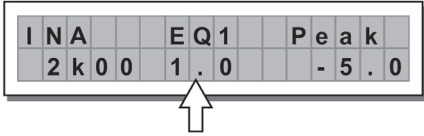

Picco

Peaking

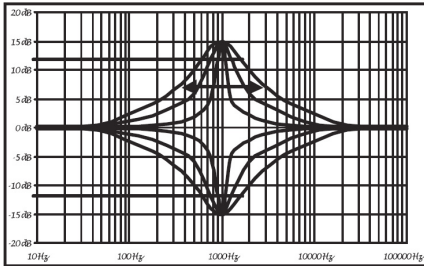

Notch

Notch

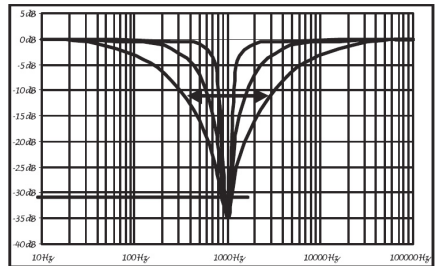

- **Gain** - Consente l'incremento o il taglio delle frequenze selezionate. Non si applica quando si utilizza il Filtro Notch

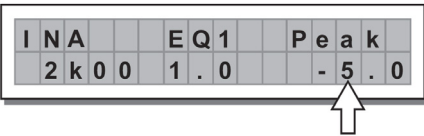

Picco

Shelving basso

Shelving alto

Peaking

Low Shelving

High Shelving

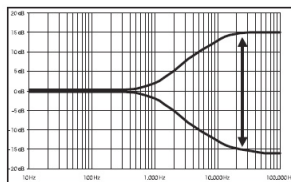
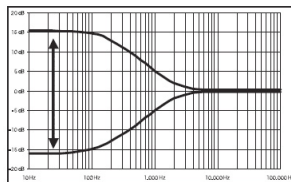
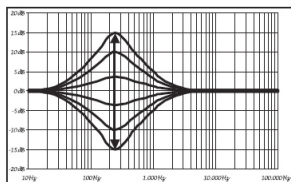

I valori di filtro possono essere configurati nei seguenti intervalli:

5-BAND FULL PARAMETRIC EQ					
NAME	TYPE	GAIN	FREQ	WIDTH	
Peak	Peaking	±15dB (step 0,5dB)	15,6Hz ~ 16kHz	0,05 ~ 3,00 oct (step 0,05 oct)	
LoSh 6	Low Shelving 6dB/oct				
LoSh 12	Low Shelving 12dB/oct				
HiSh 6	High Shelving 6dB/oct				
HiSh 12	High Shelving 12dB/oct				
Notch	Notch Filter	-45dB (fix)		0,05 ~ 3,00 oct (step 0,05 oct)	

- **Xover** - Filtri passa basso e passa alto.



Delay ► Filtro passa basso ► Filtro passa alto ► EQ a 5 bande ► Livello ► Polarità ► Limitatore ► Misuratore a LED ► Mute ► Convertitore da digitale ad analogico ► Uscita

Ciascuno Xover ha 2 pagine leggermente diverse (una per ciascun filtro), in cui vengono illustrati il nome dell'uscita su cui influisce e il tipo di filtro:

- **Filtro passa basso** - Consente il passaggio di tutte le frequenze al di sotto di un intervallo specifico e taglia tutte le altre frequenze al di sopra di esso.

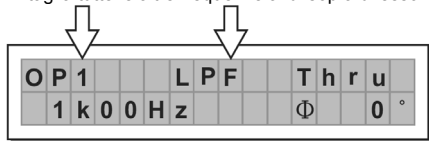

- **Filtro passa alto** - Consente il passaggio di tutte le frequenze al di sopra di un intervallo specifico e taglia tutte le altre frequenze al di sotto di esso.

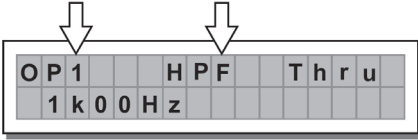

- **Frequenza di crossover** - Regola la frequenza di taglio del filtro.

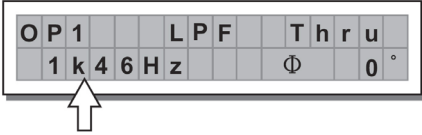

- **Phase (fase)** - Consente il controllo della fase del segnale.

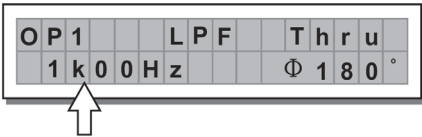

Nota bene: questo comando è disponibile unicamente nella finestra del filtro passa basso.

I valori di Xover possono essere configurati nei seguenti intervalli:

XOVER					
	NAME	TYPE	SLOPE	FREQ	PHASE
LPF	Thru			15.6Hz ~ 16KHz	0° ~ 180° (Stp 5°)
	But	Butterworth	6, 12, 18, 24 dB/oct		
	Bes	Bessel	12, 18, 24 dB/oct		
	LR	Linkwitz-Riley	12, 24, 48 dB/oct		
HPF	Thru			15.6Hz ~ 16KHz	
	Hish 6	Butterworth	6, 12, 18, 24 dB/oct		
	Hish 12	Bessel	12, 18, 24 dB/oct		
	Notch	Linkwitz-Riley	12, 24, 48 dB/oct		

Output Pol - Controlla la polarità dell'uscita. Consente di invertire la fase del segnale su singole uscite. L'effetto opera in 5 fasi in un intervallo compreso tra 0 e 180. In questo modo è possibile impostare la fase di ciascuna singola uscita con 5 fari nell'ambito di una rivoluzione completa da 360. Questa funzione è utile al momento di assemblare array di alloggiamenti di casse, nel controllo dell'interpolazione tra vari alloggiamenti o tra sezioni dello stesso sistema.



Limitatore di uscita - Mantiene il segnale di ciascuna singola uscita entro un livello stabilito.



- **Reaction times (tempi di reazione)** - Regola 3 tipi di velocità di reazione del limitatore:
 - Fast (rapida)** - Adatta per un utilizzo rapido del limitatore, solitamente per segnali dedicati alle alte frequenze.
 - Normal (normale)** - Adatto alla maggior parte delle applicazioni caratterizzate da segnali dedicati alle frequenze intermedie o sistemi full-range.
 - Slow (lenta)** - Adatta per evitare salti nel livello e per segnali dedicati alle basse frequenze.

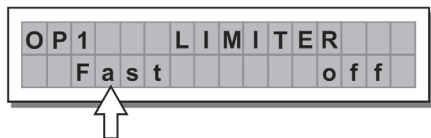

LIMITER	ATTACK	RELEASE
FAST	1 ms	10 ms
NORMAL	8 ms	80 ms
SLOW	45 ms	450 ms

- **Threshold (soglia)** - Stabilisce il livello al di sopra del quale si attiva il limitatore.

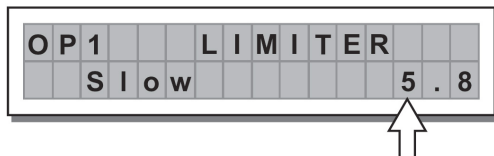

IMPORTANTE! L'attivazione del LIMITATORE su una specifica uscita cambia anche il modo in cui il livello viene visualizzato sul corrispondente LED. Il livello non sarà più il livello di uscita "assoluto", ma il livello del segnale a -24dB, -12dB, -6dB rispetto alla **soglia del LIMITATORE** (LED LIMITE arancione), indipendentemente dal valore di soglia.

MENU UTILITY (utilità) - Consente l'accesso a opzioni di sistema quali il controllo della scheda di memoria multimediale o la protezione contro modifiche accidentali o non autorizzate.

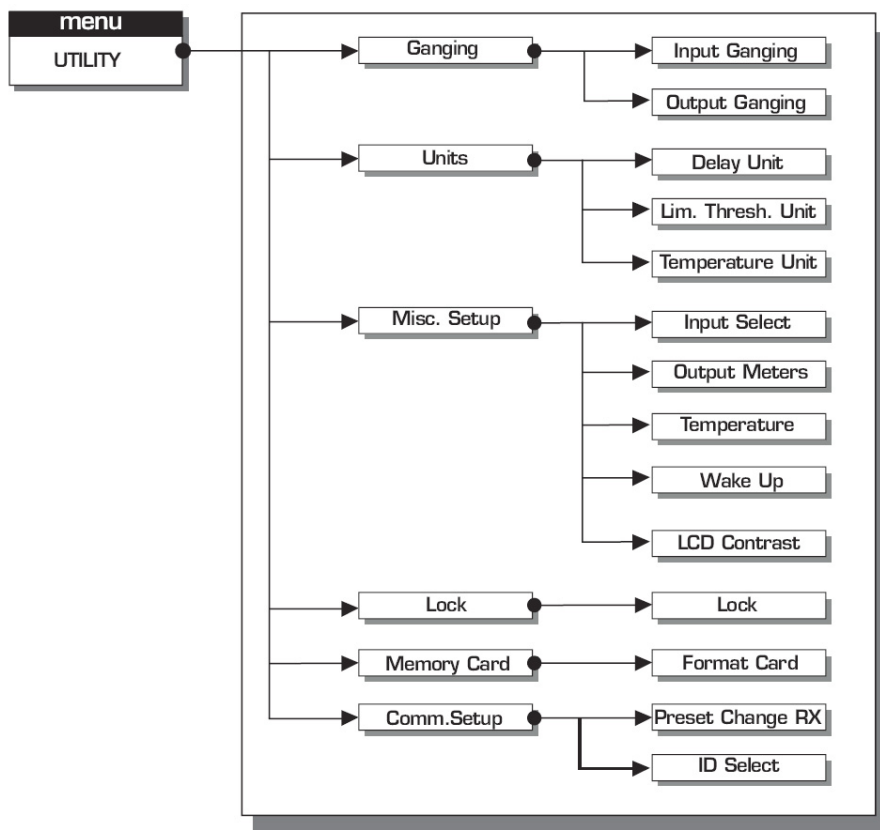

OTTOMENU GANGING - Consente di raggruppare ingressi e/o uscite. Ad esempio, può essere utilizzato per regolare le sezioni di destra e di sinistra di un segnale stereo sullo stesso valore di Delay o di equalizzazione su entrambe le uscite con una sola operazione; o impostare parametri Xover identici per le varie uscite alimentate ad un sistema audio stereo. La funzione di Ganging può essere attivata separatamente sia per gruppi di ingressi che per gruppi di uscite.

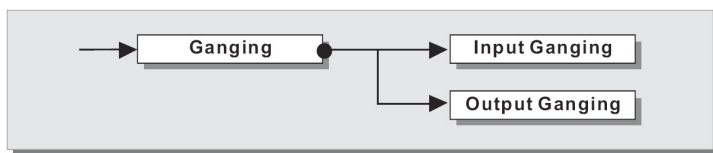

Input Ganging (raggruppamento di ingressi) - Attiva/disattiva la funzione di raggruppamento degli ingressi. Le impostazioni sono:

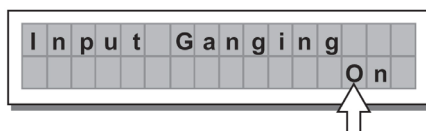
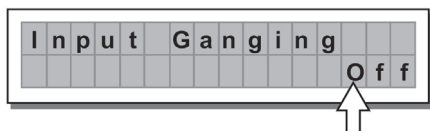

Input Ganging (raggruppamento di uscite) - Attiva/disattiva la funzione di raggruppamento delle uscite.

Le impostazioni sono:

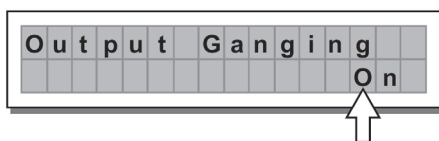
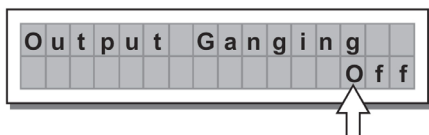

IMPORTANTE:

Non appena gli ingressi e/o le uscite sono raggruppati, le varie pagine dei menu mostrano unicamente i valori che possono essere utilizzati effettivamente.

SOTTOMENU UNITÀ

Consente di scegliere le unità di misura da utilizzare con determinate funzioni.

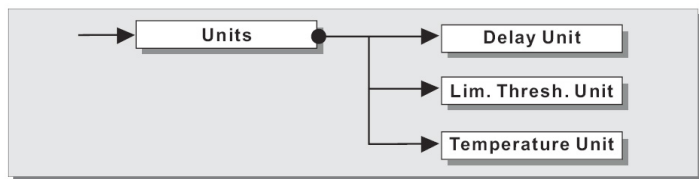

- **Delay Unit (unità di delay)** - Stabilisce la misura in cui vengono espressi i ritardi (delay).

Le opzioni includono: **m** = metri - **mm** = millimetri - **ms** = millisecondi - **µs** = microsecondi

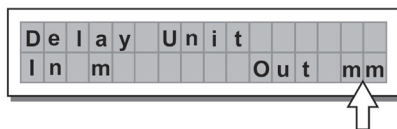
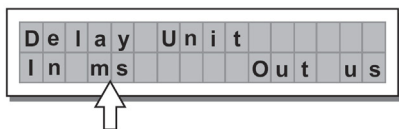

- **Lim. Thresh. Unit** - Stabilisce le unità di misura per la soglia del Limitatore (menu EDIT - Limitatore di uscita).

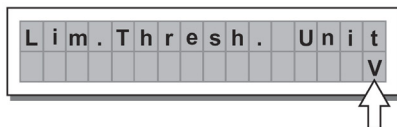

Le opzioni includono: **dBu** = decibel (0 dBu = 0,775 V rms) - **V** = volt

- **Unità di temperatura** - Stabilisce le unità di misura per la funzione Temperatura (Menu **UTILITY** - Misc. sottomenu Setup). Le opzioni includono: **C** = gradi Centigradi - **F** = gradi Fahrenheit

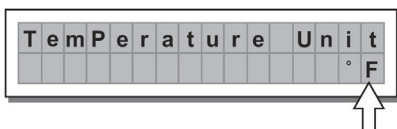
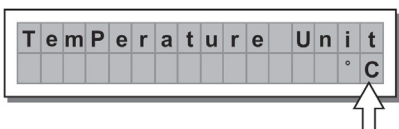

MISC. SOTTOMENU SETUP - Stabilisce una serie di opzioni di sistema.

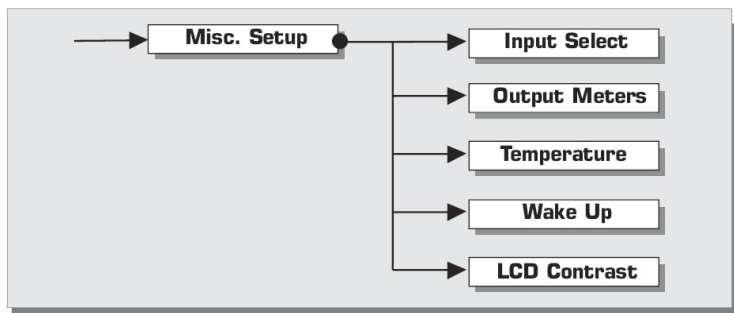

- **Input Select** - Consente di scegliere gli ingressi che lo STAGEDRIVE+ deve utilizzare, digitali o analogici.



- **Misuratori di uscita** - Possibilità di scegliere se visualizzare il segnale di uscita prima o dopo MUTE. Le opzioni includono:

PreMute - Il segnale viene mostrato sempre, indipendentemente dallo stato di MUTE
PostMute - Il segnale viene illustrato solo se l'uscita non è in MUTE

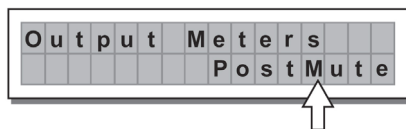
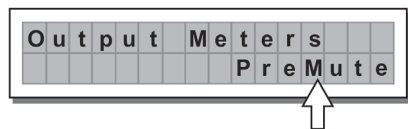

- **Temperatura** - Stabilisce il valore della temperatura ambiente nel luogo dell'installazione per compensare per i differenziali dovuti alla velocità variabile della trasmissione del suono dovuta alla temperatura dell'aria. I valori di modifica rientrano nei seguenti intervalli: **+60 C ~ -30 C** con passi di 1 C **140,0 F ~ -22,0 F** con passi di 1,8 F

Nota bene: le unità di misura possono essere scelte tra C (gradi Centigradi) ed F (gradi Fahrenheit) tramite la funzione Temperature Unit (unità di temperatura) (menu UTILITY - sottomenu Units).

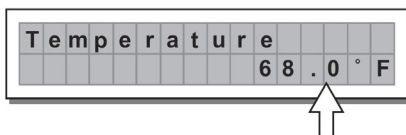
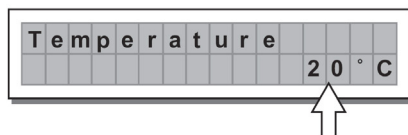

- **Wake Up** - Stabilisce la modalità in cui le funzioni MUTE vengono ristabilite quando lo STAGEDRIVE+ è acceso. Le opzioni includono:

Normal - Quando acceso, il sistema ripristina l'ultima configurazione MUTE prima dello spegnimento
Mute - Quando acceso, il sistema imposta automaticamente tutte le uscite in MUTE

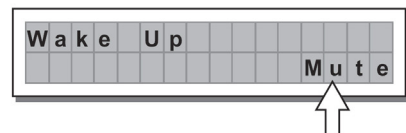
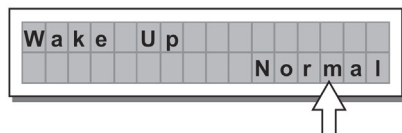

Contrasto LCD - Regola il contrasto del Display.

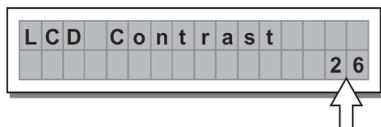

SOTTOMENU LOCK - Utilizzato per attivare o disattivare la protezione del sistema contro modifiche accidentali o non autorizzate.

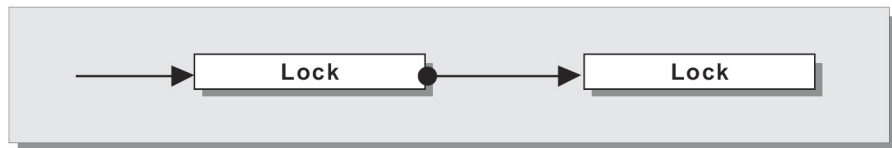

Come abilitare la protezione

1. Scegliere una modalità di protezione (parziale o totale).
2. Servirsi dei tasti ◀ e ▶ per accedere all'area in cui viene inserita la **password**.
3. La password può essere composta da quattro caratteri alfanumerici, ottenibili servendosi dei tasti ◀ e ▶ e modificabile con la **ROTELLA**.
4. Dopo aver inserito la password, premere **INVIO**.

Nota bene: la conferma è accettata unicamente se il cursore viene posizionato su uno dei quattro caratteri della password. Ciò impedisce l'attivazione accidentale della protezione senza aver visto la password.

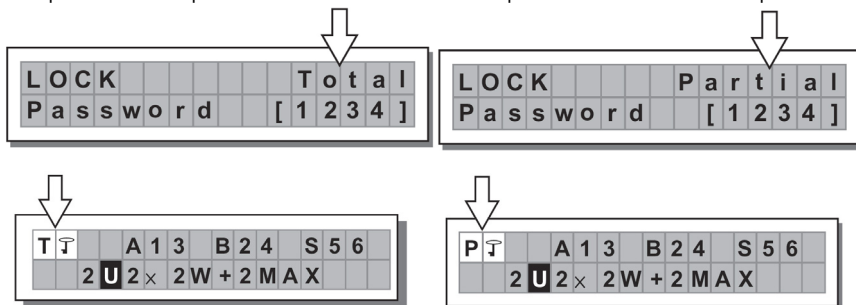

Come disabilitare la protezione

1. Accedere al sottomenu **LOCK**.
2. Il display mostra il messaggio per l'inserimento della password per sbloccare la protezione.
3. Inserire la **password** servendosi della combinazione dei tasti ◀ e ▶ e della **MANOPOLA**, quindi premere **INVIO**.

Nota bene: nel caso dell'inserimento di una password errata, il display invia nuovamente la richiesta di inserimento, criptando tutti i caratteri.

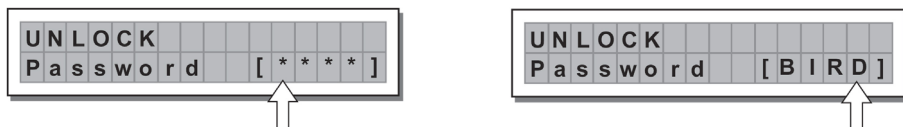

IMPORTANTE! Se non si ricorda la password, accendere l'apparecchio premendo i tasti **"PREV"** e **"◀"**. Ora la protezione è sbloccata.

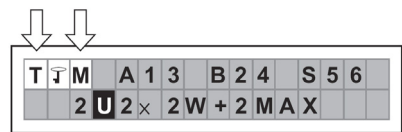

Nota bene: accanto al simbolo della protezione totale o parziale, può comparire la lettera "M". Ciò significa che il sistema è protetto, ma il PRESET in questione è stato sottoposto a una o più modifiche che non sono ancora state memorizzate. È tuttavia possibile accendere e spegnere il sistema senza problemi, in quanto le configurazioni attuali sono conservate nella memoria del buffer. Se tuttavia si tratta del setup principale, si consiglia di memorizzarlo in un PRESET.

SOTTOMENU SCHEDA DI MEMORIA - Consente la formattazione (cancellazione) della scheda di memoria multimediale. Una scheda non può essere utilizzata correttamente dal sistema se non viene prima formattata nell'apparecchio.

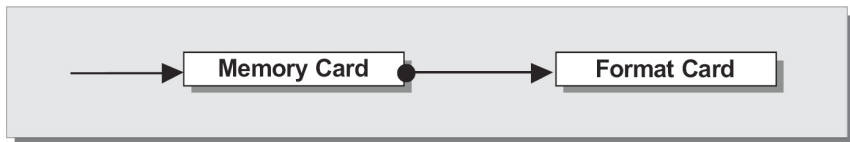

Come formattare la scheda

1. Inserire una scheda di memoria multimediale nello slot.
2. Nel sottomenu Memory Card (scheda di memoria), premere **INVIO**.
3. Premere nuovamente **INVIO** per iniziare la formattazione.
4. Il sistema formatta la scheda fino a comunicare il completamento dell'operazione.



Nota bene: in caso di errore o di guasto di una scheda, se non vi è alcuna scheda nello slot o se la scheda viene rimossa durante la formattazione, a display compare il seguente messaggio:

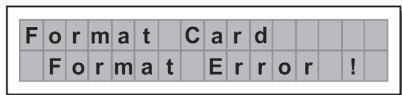

Durante la formattazione, il sistema memorizza automaticamente il preset *Default* in tutte e 128 le aree di memoria della SCHEDA.

Nota bene: poiché il sistema deve sempre essere configurato, non vi sono aree di memoria vuote. Tutte le aree User (utente) e Card (scheda) non ancora utilizzate da dati utente memorizzate sono occupate automaticamente dal PRESET *Default*, che contiene una configurazione di avvio standard con tutti i valori dei vari parametri a zero.

COMM. SETUP SUBMENU

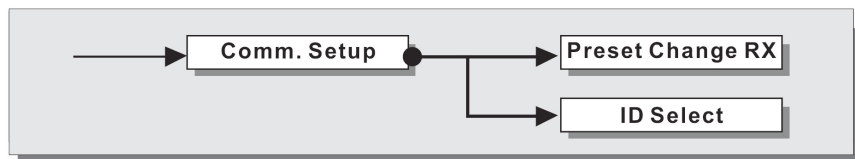

Questo sottomenu consente l'accesso alla configurazione della comunicazione con altri apparecchi tramite le porte RS485.

Nota bene: Le funzioni 'Dump Out Preset' e 'Incoming Dump' sono un'eccezione in quanto sono controllate direttamente nel menu PRESET.

PRESET Change RX

Consente di accettare o ignorare il comando PRESET Change inviato tramite la porta USB o un altro STAGEDRIVE+ quando carica un PRESET. Le configurazioni possono essere:

- Ignorare i comandi PRESET Change ricevuti.
- Accettare ed eseguire comandi PRESET Change.

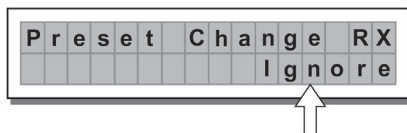
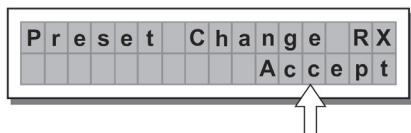

CONFIGURAZIONE DRIVER DEL SOFTWARE

1. Inserire il CD recante il software in dotazione nel lettore del computer
2. Navigare fino alla cartella MaxiDrive3.4 DPA software/USB Driver per individuare e installare il file PL-2303 Driver Installer.exe associato alla propria versione di Windows.
3. Una volta installato il driver, accendere lo STAGEDRIVE+ e collegare il cavo USB dalla porta USB dello STAGEDRIVE + alla porta USB del PC.
4. Fare clic col tasto destro del mouse su **MY COMPUTER** quindi cliccare su **PROPRIETÀ**
5. Cliccare sulla scheda **HARDWARE**, quindi selezionare **DEVICE MANAGER**
6. Fare doppio clic su **PORTS (COM & LPT)**, e cercare la porta **PROLIFIC USB-to-SERIAL Com**
7. Fare doppio clic sulla porta **PROLIFIC USB-to-SERIAL Com**, quindi cliccare su **PORT SETTINGS**, e poi su **ADVANCED**
8. Cambiare il **COM PORT NUMBER (numero della porta COM)** su **COM1** (o qualsiasi altra porta con non in uso) e cliccare su **Ok**.

CONFIGURAZIONE DEL SOFTWARE

L'editor del software può essere configurato come segue:

1. Una volta installato il driver del software (con lo STAGEDRIVE+ acceso e collegato al computer via USB), lanciare il programma di editing.
2. Selezionare **New (nuovo)**.

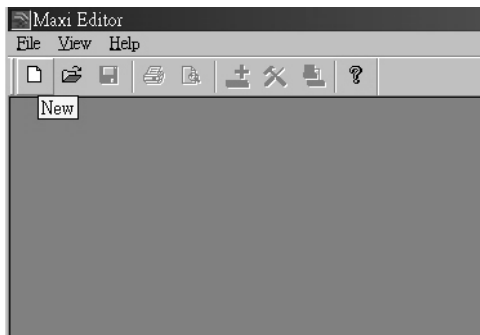

3. Selezionare la propria interfaccia dall'elenco.

4. Selezionare **Network Scan** (scansione della rete).

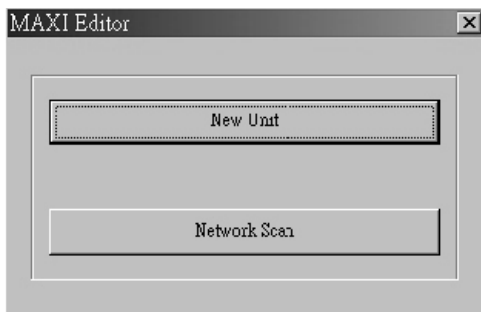

5. Se la scansione di rete (Network Scan) fallisce, verificare il **Device ID number (numero di dispositivo)**. Selezionare **New Unit (nuova unità)**, e selezionare l'Interfaccia. Assicurarsi che il numero di STAGEDRIVE+ ID sia 1 o corrisponda al numero di identificazione del dispositivo.
6. Selezionare **OK**, entrando nell'interfaccia successiva:

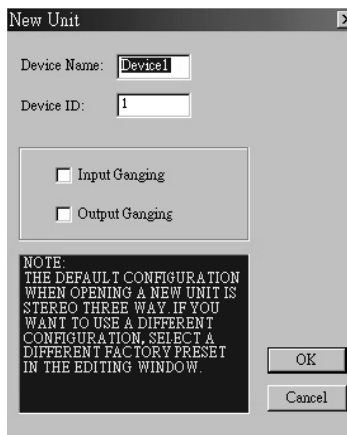

7. Selezionare l'icona **Options**, entrando nell'interfaccia successiva:

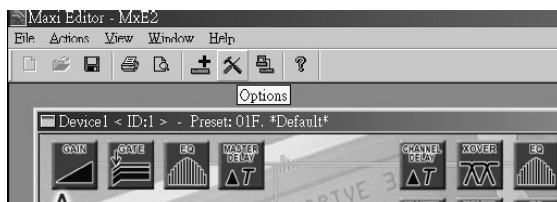

- Selezionare **Rs232** con l'impostazione COM prescelta durante la configurazione dei driver del software driver per la Porta e 38400 (o 19200) come Baud Rate.

NOTA BENE: assicurarsi che le impostazioni del computer corrispondano a quelle dello STAGEDRIVE+

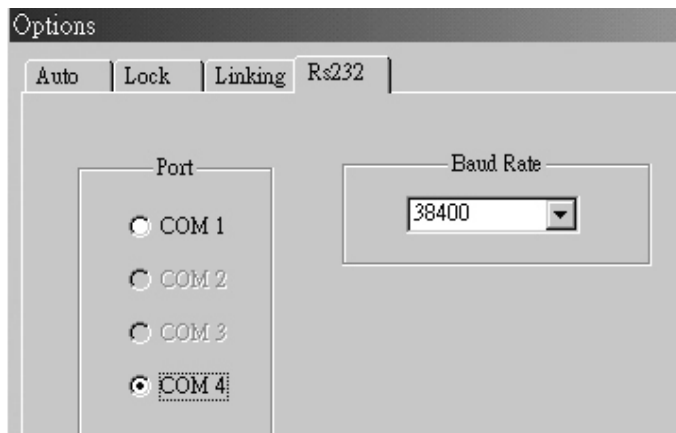

- Selezionare **On/Off Line** sull'interfaccia principale dopo aver selezionato **OK**.

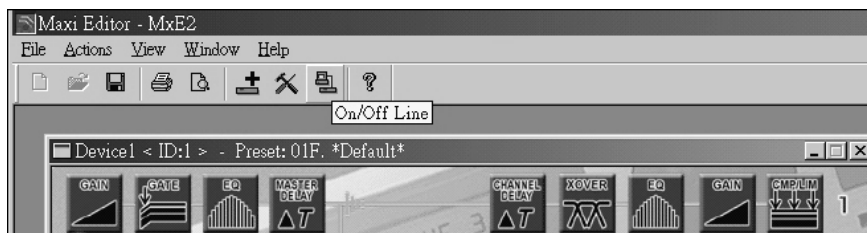

- Mostrerà a display l'interfaccia. Selezionare **OK**, quindi si collegherà all'attrezzatura.

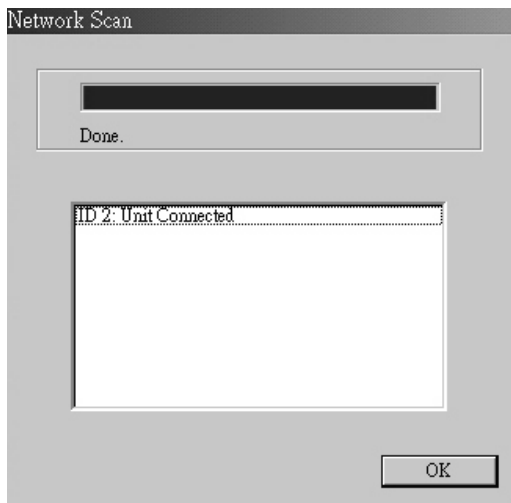

11. Quando il link è collegato, mostrerà a display "ONLINE".



ESEMPI DI COLLEGAMENTO

I seguenti esempi aiuteranno a collegare e utilizzare lo STAGEDRIVE+.
A13 B24 S56 2-WAY STEREO+2 MONO AUX [2 2W+2MAX]

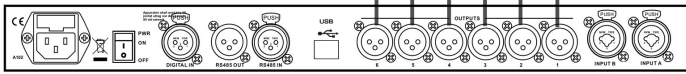
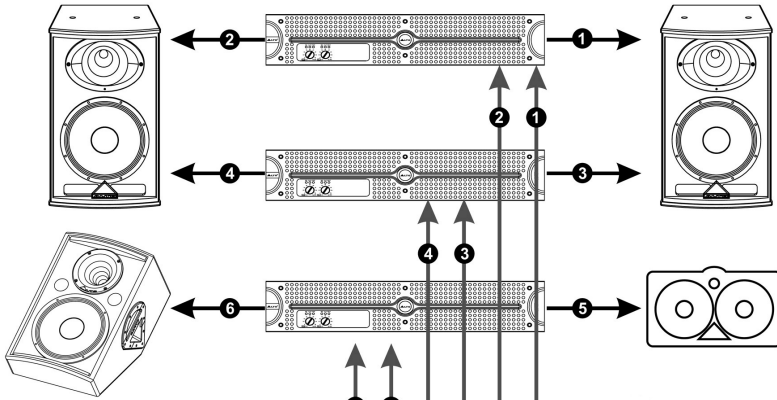
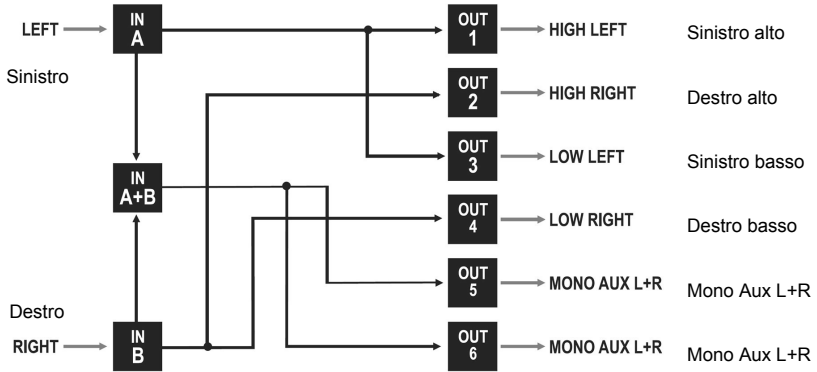

STAGEDRIVE+



Segnale
 Alimentazione

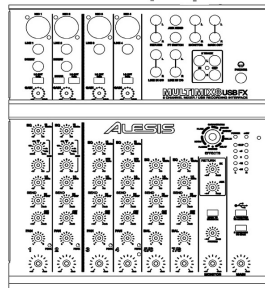

A135 B246 3-WAY STEREO [2X3W]

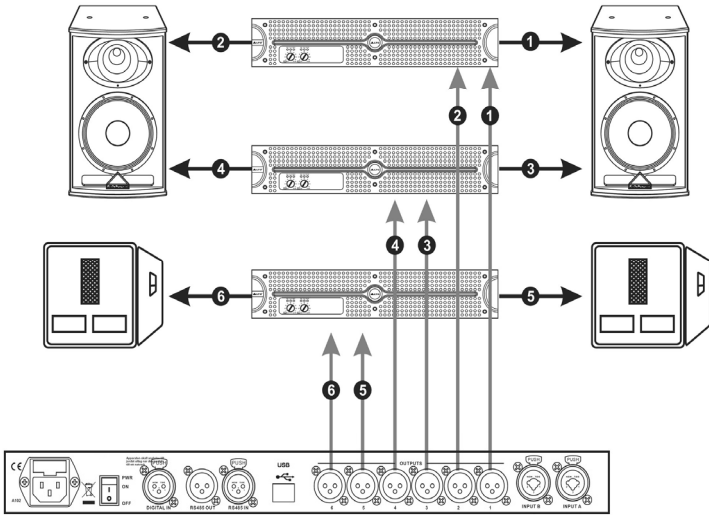
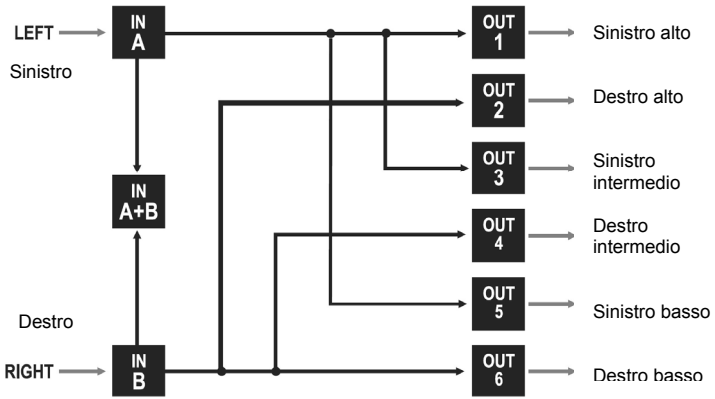

STAGEDRIVE+



Segnale

Alimentazione

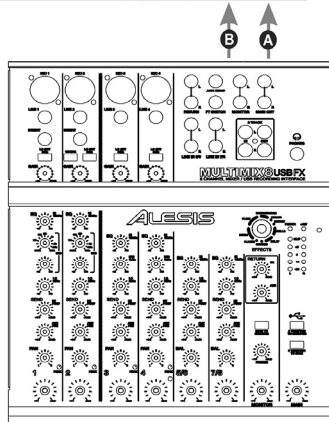

A13 B24 S56 3-WAY STEREO con MONO SUB+MONO AUX [2 3W+MSB+MAX]

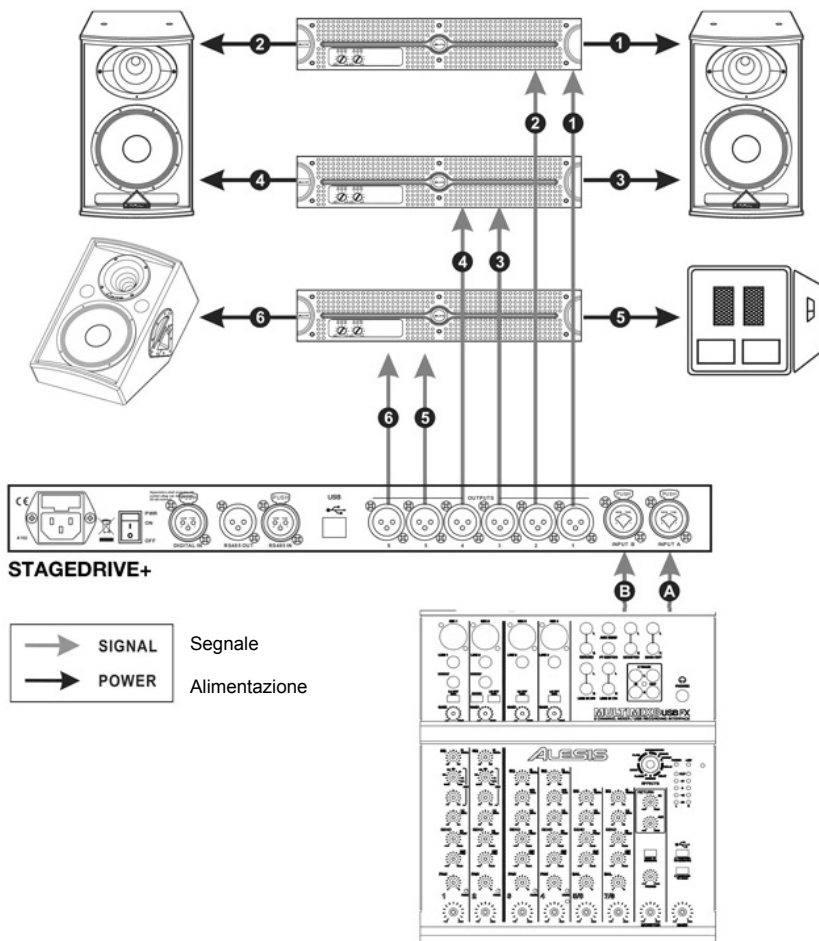

A1324 S56 4-WAY 4 MONO + 2 MONO AUX [4W+2MAX]

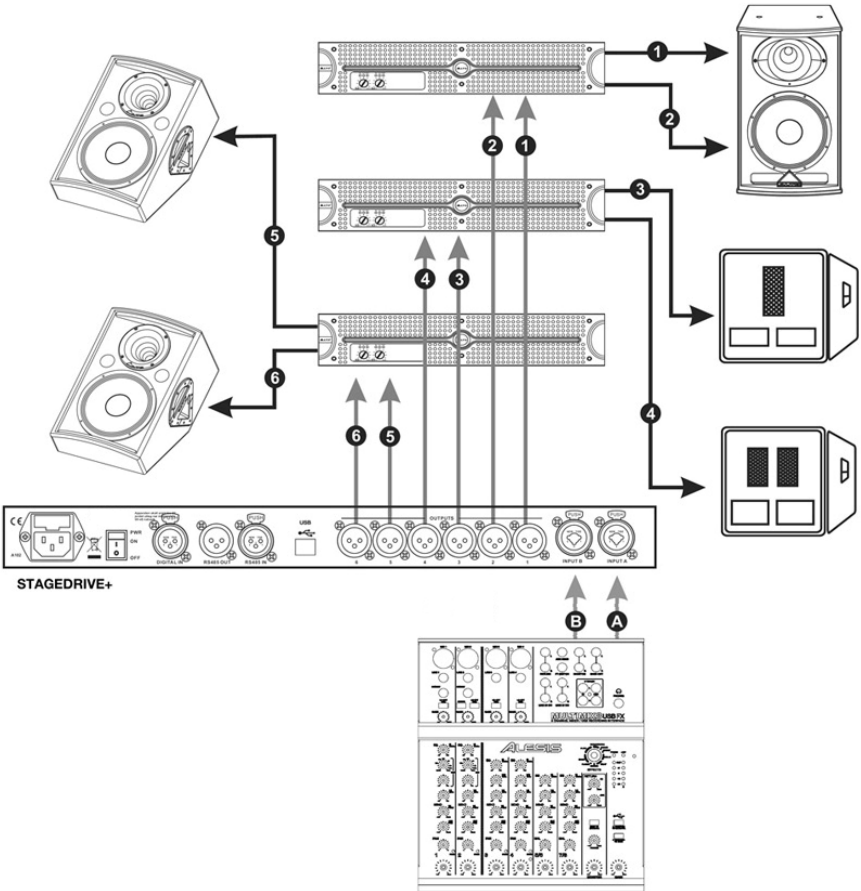
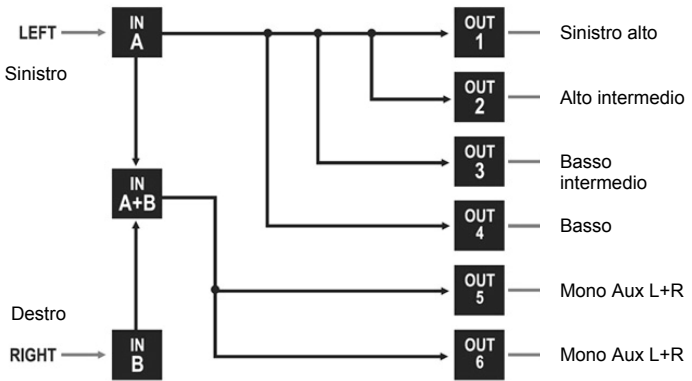

A135 B246 3-WAY STEREO [2x2W]

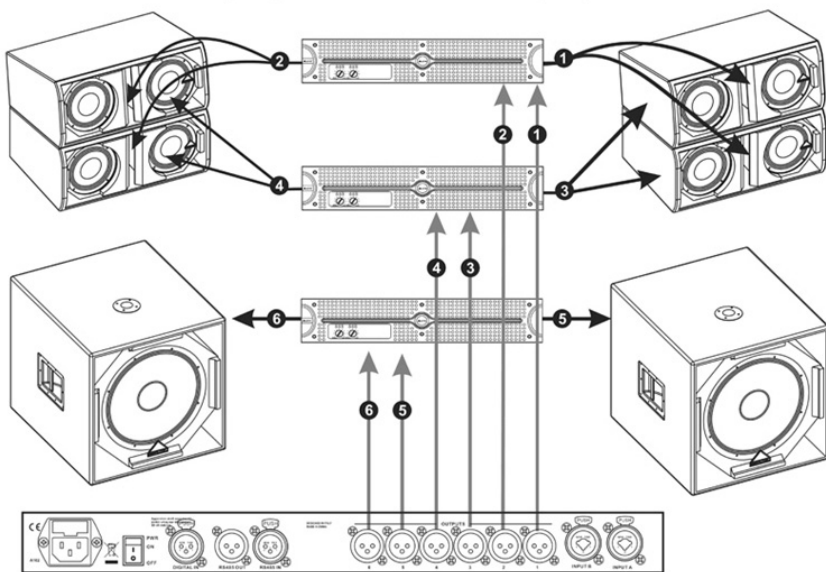
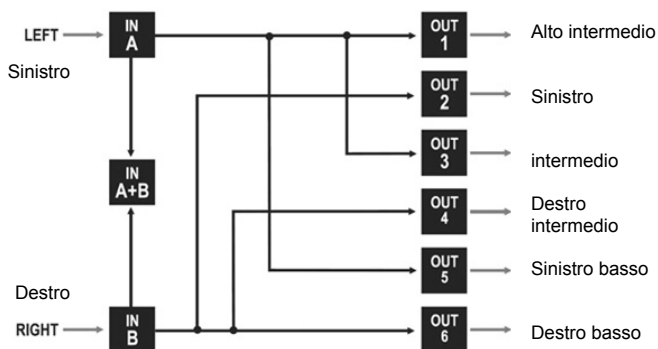

STAGEDRIVE+

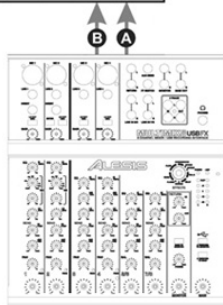

SCHNELLSTART-ANLEITUNG (DEUTSCH)

LIEFERUMFANG

STAGEDRIVE+
 Netzkabel
 Software-CD
 Schnellstart-Anleitung
 Sicherheitshinweise und Garantieinformationen

SCHNELLES EINRICHTEN

1. Stellen Sie sicher, dass alle im LIEFERUMFANG aufgelisteten Teile in der Verpackung enthalten sind.
2. **LESEN SIE DIE SICHERHEITSHINWEISE & GARANTIEINFORMATIONEN BEVOR SIE DAS PRODUKT VERWENDEN.**
3. Werfen Sie einen Blick auf die Anschlussübersicht in diesem Handbuch.
4. Für den Betrieb platzieren Sie alle Geräte an einem geeigneten Standort.
5. Stellen Sie sicher, dass alle Geräte ausgeschaltet sind und alle Fader und Gain-Regler auf "Null" stehen.
6. Schließen Sie alle Ausgänge der Tonquellen an die Verstärkereingänge an wie im Diagramm dargestellt.
7. Verbinden Sie die Ausgänge des Verstärkers mit den Lautsprechern.
8. Schließen Sie alle Geräte an eine geeignete Stromquelle an.
9. Schalten Sie alles in der folgenden Reihenfolge ein:
 - Tonquellen (z.B. Mikrofone, Turntables, CD-Player etc.)
 - Mixer
 - Verstärker
 - Lautsprecher
10. Beim Ausschalten drehen Sie alles in der folgenden Reihenfolge ab:
 - Lautsprecher
 - Verstärker
 - Mixer
 - Tonquellen

DARSTELLUNG DER FRONTANSICHT

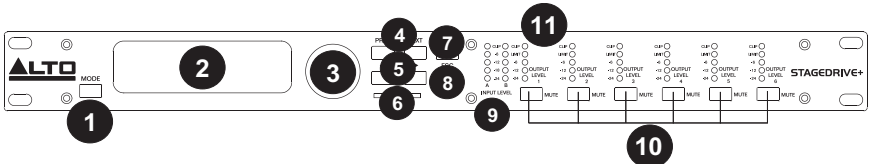

1. **MODUS-TASTE**- Wählt aus vier Modi aus: PRESET, DELAY, EDIT (BEARBEITEN) und UTILITY (OPTIONEN).
2. **DISPLAY**- Zeigt die Seiten der verschiedenen Menüs und deren Parameter an.
3. **DATENRAD**- Zum Einstellen eines Werts für den gewählten Parameter.
4. **ZURÜCK/WEITER-TASTE**- Ruft Menüseiten und/oder Parameter auf.
5. **NAVIGATIONSTASTEN**- Wählt verschiedene Parameter aus.
6. **SPEICHERKARTENSTECKPLATZ**- MMC-Kartenslot zum Speichern von PRESETS.
7. **ENTER-TASTE**- Bestätigt das Bearbeiten von Parametern.
8. **ESC-TASTE**- Mit dieser Taste können Sie die ausgewählte Bearbeitungsseite verlassen oder einen Bearbeitungsvorgang abbrechen.
9. **EINGANGSPEGEL-LEDs**- Zeigt den Pegel von Eingang A/B an.
10. **MUTE-SCHALTER**- Schaltet das Signal von einem der sechs Ausgänge stumm.
11. **AUSGANGSPEGEL-LEDs**- Zeigt den Ausgangspegel.

Hinweis: Der LIMITER ändert die Art und Weise, in der der Ausgangspegel auf der entsprechenden LED angezeigt wird. Der Pegel, der auf der Anzeige zu sehen ist, ist nicht mehr der "absolute" Ausgangspegel, sondern der Signalpegel -24dB, -12dB, -6dB im Vergleich zum Limiter-Schwellenwert (durch orangefarbene LIMIT-LED angezeigt).

DARSTELLUNG DER RÜCKSEITE

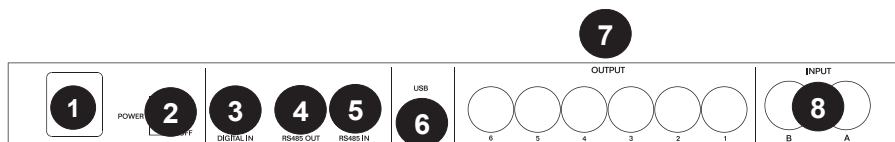

- AC-EINGANG UND SICHERUNGSHALTER**- Schließen Sie das mitgelieferte Netzkabel hier an.
ACHTUNG: Wenn die Sicherung ersetzt werden muss, wenden Sie sich an einen qualifizierten Techniker. Wenn die Sicherung auch nach dem Austauschen weiterhin durchbrennt, schalten Sie diese Einheit aus und lassen sie reparieren.
- NETZSCHALTER**- Schaltet die Hauptstromversorgung ein/aus.
- DIGITALEINGANG**- Schließen Sie ein symmetrisches XLR-F-Kabel hier an.
- RS485-AUSGANG**- Erlaubt ausgehende Kommunikation zwischen einem STAGEDRIVE+ und anderen STAGEDRIVE+ Einheiten.
- RS485-EINGANG**- Ermöglicht eingehende Kommunikation zwischen einem STAGEDRIVE+ und anderen STAGEDRIVE+ Einheiten.
- USB-ANSCHLUSS**- Ermöglicht den Austausch via PC.
- AUSGÄNGE**- Verwenden Sie für diese Ausgänge symmetrische XLR-M-Kabel.
- EINGÄNGE**- Symmetrische XLR - ¼"-Combobuchsen.

ERSTE SCHRITTE

Anpassen des Eingangssignals

- Bringen Sie die STAGEDRIVE+ Ausgänge in den MUTE-Modus (LEDs leuchten), indem Sie die jeweilige Mute-Taste auf der Vorderseite drücken.
- Leiten Sie ein Signal in den STAGEDRIVE+ Eingang und beobachten Sie die LED-Anzeige des **EINGANGSPEGELS A-B**.
- Das Signal sollte laut sein, die **CLIP**-LED darf jedoch nicht ständig leuchten. Passen Sie bei Bedarf die Eingangsverstärkung an.
- Drücken Sie die Taste **MODUS** bis die LED des Menüs **BEARBEITEN** aufleuchtet. Verwenden Sie die Tasten **ZURÜCK** und **WEITER**, um zur Seite **Eingangsverstärkung** zu gelangen und drücken Sie dann **ENTER**.
- Mit dem **DATENRAD** ändern Sie den Verstärkungswert und beobachten den Signalpegel auf der LED-Anzeige bis der ideale Wert erreicht wird.
- Verwenden Sie die Tasten **ZURÜCK** und **WEITER**, um zur Seite **INB-Gain** zu gelangen.

MENÜS

PRESET-Menü

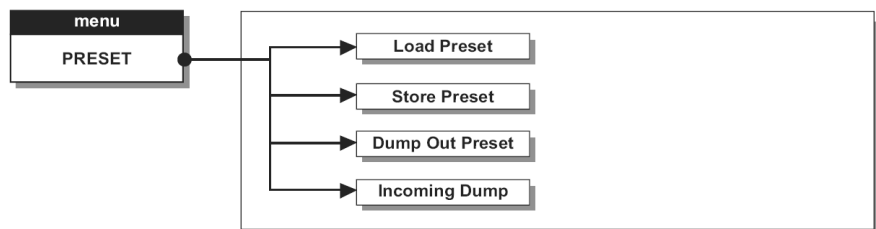

PRESET-Kategorien

Es gibt 3 PRESET-Kategorien:

- **F** = Werks-PRESETS, die nicht dauerhaft verändert werden können. Sie werden als Ausgangspunkte verwendet, um eigene Anwender-PRESETS und Karten-PRESETS von Grund auf zu erstellen.
- **U** = Anwender-PRESETS können von den Anwendern programmiert werden.
- **C** = Karten-PRESETS können von den Anwendern programmiert werden und auf einer Multimedia-Speicherkarte gespeichert werden.

So laden Sie ein PRESET:

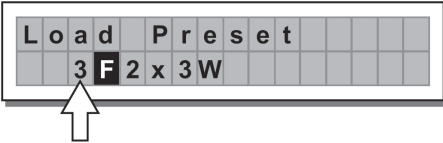

- Verwenden Sie das DATENRAD, um ein Werks-PRESET (gekennzeichnet durch den Buchstaben F) auszuwählen und drücken Sie ENTER, um das Preset in den Speicher zu laden.



Anpassen der Eingangsverstärkung



1. Bringen Sie die STAGEDRIVE-Ausgänge in den MUTE-Modus (LEDs leuchten auf).
2. Leiten Sie ein Signal in den STAGEDRIVE+ Eingang und beobachten Sie die LED-Anzeige.
3. Um eine gute Signalstärke zu erhalten, sorgen Sie dafür, dass die rote A-B CLIP-LED des EINGANGSPEGELS nicht durchgehend leuchtet.
4. Ermitteln Sie die richtige Ausgangspegel-Einstellung Ihres Mixers (oder eines anderen Geräts) und verbinden Sie ihn mit dem Eingang des STAGEDRIVE+.
5. Passen Sie die Eingangsverstärkung des STAGEDRIVE+ an, indem Sie die Taste MODUS drücken bis die LED des Menüs BEARBEITEN aufleuchtet.
6. Verwenden Sie die Tasten ZURÜCK und WEITER, um zur Seite Eingangsverstärkung zu gelangen:
7. Drücken Sie die Taste ENTER. Das Display zeigt die Seite IN A Gain (Eingangsverstärkung von A) oder die IN A&B Gain (Eingangsverstärkung von A&B) (je nach Konfiguration und anderen Optionen, die in den Speicher geladen wurden)
8. Mit dem DATENRAD ändern Sie den Verstärkungswert und beobachten den Signalpegel auf der LED-Anzeige bis der ideale Wert erreicht wird. Verwenden Sie dann die Tasten ZURÜCK und WEITER, um zur Seite IN B Gain (Eingangsverstärkung B) zu gelangen (falls diese Seite besteht, was von der Konfiguration und anderen Optionen abhängt, die in den Speicher geladen wurden).

So speichern Sie ein PRESET:

1. Verwenden Sie das DATENRAD, um einen Bereich auszuwählen, in dem das PRESET gespeichert werden soll und drücken **ENTER**.
2. Verwenden Sie **◀** und **▶**, um den Cursor auf ein Zeichen zu positionieren und verwenden Sie dann das DATENRAD, um den alphanumerischen Wert einzugeben.
3. Sie können den **PRESET**-Namen bearbeiten und **ENTER** drücken, um die Änderungen zu speichern oder **ESC** drücken, um abzubrechen.

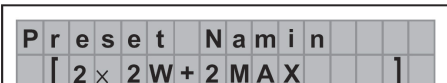

UNTERMENÜ KOMM.-SETUP- Dieses Untermenü ermöglicht den Zugriff auf die Kommunikationseinstellungen anderer Geräte über den USB-Anschluss.

Hinweis: Die Funktionen "Dump Out Preset" ("Preset auslesen") und "Incoming Dump" ("Eingehende Daten auslesen") bilden Ausnahmen, da sie direkt vom PRESET-Menü gesteuert werden.

PRESETS übertragen- Verwenden Sie diese Menüseite, um PRESETS über die RS485-Ports zu übertragen, um sie auf ein anderes STAGEDRIVE+ zu kopieren.

Herunterladen eines PRESETS- Wählen Sie ein PRESET mit dem DATENRAD aus und drücken Sie ENTER.

Hinweis: Die Menüseite bleibt unverändert, damit andere PRESETS ausgelesen werden können. Alle Preset-Daten (Name, Konfiguration, Parameterwerte etc.) werden sofort an die Einheiten übertragen, die an den RS485-Port angeschlossen sind.

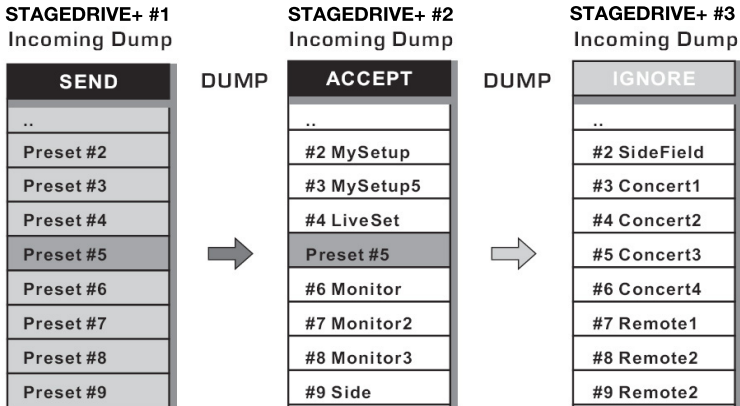

Hinweis: Damit die Übertragung funktioniert, müssen die Empfangsgeräte in der Lage sein, eingehende Auslesevorgänge zu erkennen und zu akzeptieren. Wenn zwei oder mehr STAGEDRIVE+ angeschlossen sind, überschreibt das PRESET, das vom übertragenden STAGEDRIVE+ gesendet wurde, das bestehende PRESET auf der gleichen Speicherstelle des empfangenden STAGEDRIVE+.

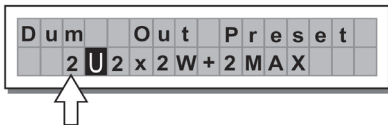

Incoming Dump (Eingehende Daten auslesen)

Akzeptiert oder ignoriert das Auslesen eines PRESETS, das von einem anderen STAGEDRIVE+ über den RS485-Port oder über einen Computer via USB gesendet wurde. Folgende Port-Einstellungen sind möglich:

- Gesendete Daten ignorieren
- Gesendete Daten akzeptieren

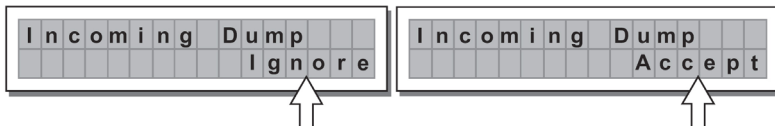

Systemsperrfunktion

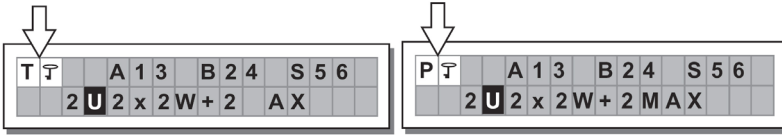

Diese Anzeige erscheint, wenn die **SPERR**-Funktion aktiviert ist, (d.h. wenn das SPERRSYSTEM komplett (T) oder teilweise (P) gegen versehentliche oder unbefugte Änderungen schützt). Diese Sperrfunktion ist durch ein Passwort geschützt, ohne das keine Bearbeitung möglich ist.

DELAY-MENÜ

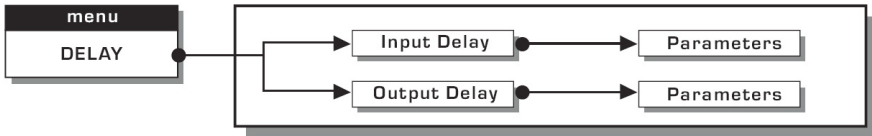

Eingangs-Delay: Verzögert das Signal des Eingangs (oder der Summe aller Eingänge), bevor es an das Routing-System gesendet wird. Alle Ausgänge werden mit der gleichen Verzögerungszeit versehen. Dies wird häufig verwendet, um Abstände zwischen Lautsprechern oder in großen Hallen auszugleichen.

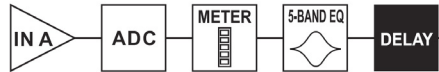
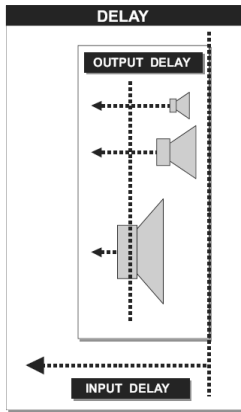

Eingang A ▶ Analog-Digital-Wandler ▶ LED-Anzeige ▶ 5-Band EQ ▶ Delay

Die Werte des Eingangs-Delays können in folgenden Bereichen gesetzt werden:

INPUT DELAY		
unit	range	step
m	0.0 ~ 900.0	0.5
mm	0 ~ 900000	7
ms	0 ~ 2621	1
us	0 ~ 2621438	21

Die Maßeinheit kann mit der Funktion Delay-Einheit ausgewählt werden (Menü OPTIONEN - Untermenü Einheiten).

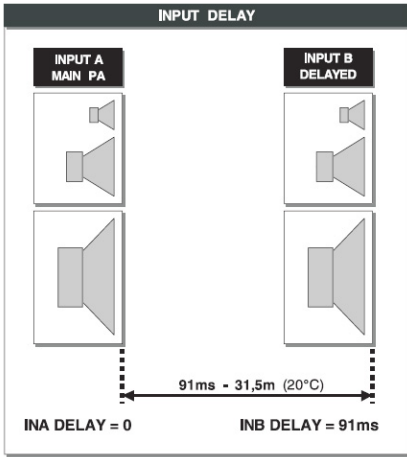

- **Ausgangs-Delay:** Verzögert nur das Signal eines bestimmten Ausgangs. Dies wird verwendet, um den Abstand zwischen verschiedenen Lautsprechern im gleichen Sound-System (z.B. Lautsprecher-Cluster) zu kompensieren oder um eine internen Ausrichtung von Lautsprecher-Gehäusekomponenten zu erzielen.



Delay ▶ Tiefpassfilter ▶ Hochpassfilter ▶ 5-Band EQ ▶ Pegel ▶ Polarität ▶ Limiter ▶ LED-Anzeige ▶ Mute ▶ Digital-Analog-Wandler ▶ Ausgang

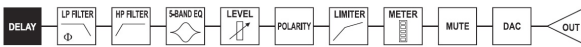

Die Werte des Ausgangs-Delays können in folgenden Bereichen gesetzt werden:

OUTPUT DELAY		
unit	range	step
m	0.0 ~ 100.0	0.5
mm	0 ~ 100000	7
ms	0 ~ 291	1
us	0 ~ 291271	21

Die Werte des Ausgangs-Delays können in folgenden Bereichen gesetzt werden:

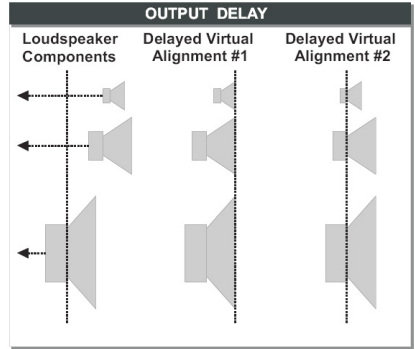
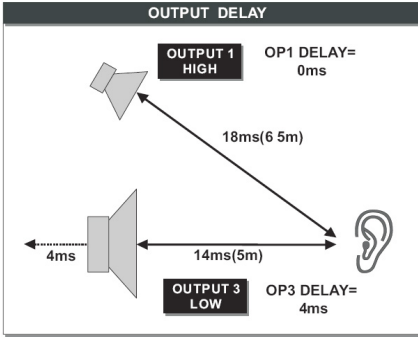

MENÜ BEARBEITEN

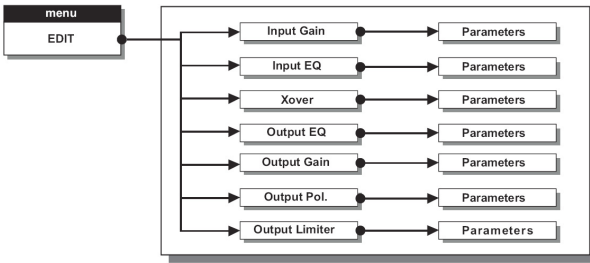

Noise Gate für den Eingang- Reduziert Hintergrundgeräusche, die von einer Einheit erzeugt werden, die an den Prozessoreingang angeschlossen ist (z.B. Mixer). Der Filter ist aktiv, wenn das Eingangssignal unterhalb eines bestimmten Schwellenwertes liegt und reduziert seinen Pegel, um unerwünschte Hintergrundgeräusche zu eliminieren.

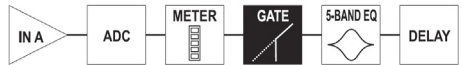

Eingang A ▶ Analog-Digital-Wandler ▶ LED-Anzeige ▶ Gate ▶ 5-Band EQ ▶ Delay

Auf zwei verschiedenen Seiten stehen folgende editierbare Parameter zur Verfügung:

a. Noise Gate EIN/AUS

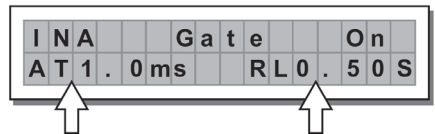
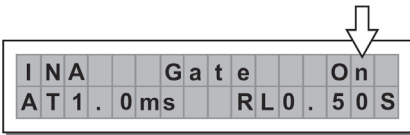

b. Reaktionszeiten- Legt die Attack- und Release-Zeiten des Noise Gate fest.

- **ATTACK (AT):** Die Zeit, die der Filter benötigt, um das Signal wieder auf den normalen Pegel zu bringen, wenn es den Schwellenwert übersteigt.
- **RELEASE (RL):** Die Zeit, die der Filter benötigt, um das Signal abzusenken sobald es unter den Schwellenwert fällt.

- **Bandbreite**- Legt die Bandbreite der Peak- oder Notch-Kurve fest. Dies gilt nicht für Shelving-Kurven

I	N	A				E	Q	1				P	e	a	k
2	k	0	0			1	.	0				-	5	.	0



Peaking

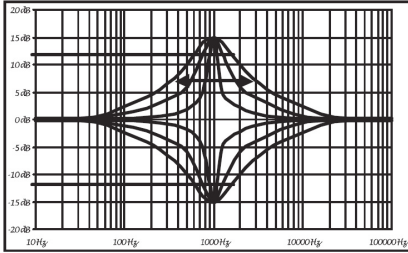

Notch

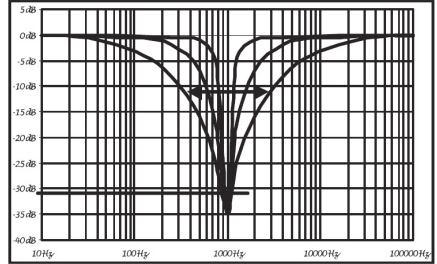

- **Gain**- Zum Anheben oder Absenken der ausgewählten Frequenzen. Dies wird nicht angewendet, wenn Sie den **Notch-Filter** verwenden

I	N	A				E	Q	1				P	e	a	k
2	k	0	0			1	.	0				-	5	.	0



Peaking

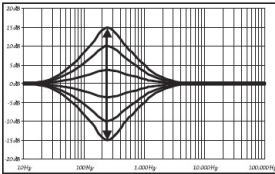

Low Shelving

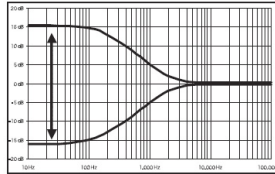

High Shelving

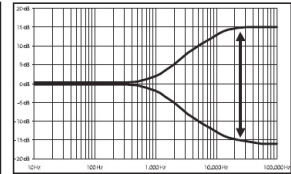

Die Filterwerte können in folgenden Bereichen gesetzt werden:

5-BAND FULL PARAMETRIC EQ					
NAME	TYPE	GAIN	FREQ	WIDTH	
Peak	Peaking	±15dB (step 0.5dB)	15.6Hz ~ 16kHz	0,05 ~ 3,00 oct (step 0.05 oct)	
LoSh 6	Low Shelving 6dB/oct				
LoSh 12	Low Shelving 12dB/oct				
HiSh 6	High Shelving 6dB/oct				
HiSh 12	High Shelving 12dB/oct				
Notch	Notch Filter	- 45dB (fix)		0,05 ~ 3,00 oct (step 0.05 oct)	

- **Crossover-** Tiefpass- und Hochpass-Filter.

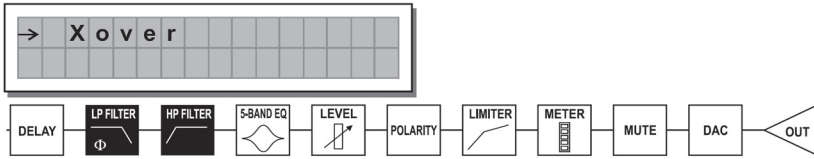

Delay ▶ Tiefpassfilter ▶ Hochpassfilter ▶ 5-Band EQ ▶ Pegel ▶ Polarität ▶ Limiter ▶ LED-Anzeige ▶ Mute ▶ Digital-Analog-Wandler ▶ Ausgang

Jeder Crossover wird auf 2 leicht unterschiedlichen Seiten konfiguriert (eine Seite pro Filter), in denen der Name des betroffenen Ausgangs und der Filtertyp angezeigt wird:

- **Tiefpass-Filter** - Alle Frequenzen unterhalb eines bestimmten Bereichs werden weiterverarbeitet, alle anderen Frequenzen oberhalb dieses Bereichs werden abgeschnitten.

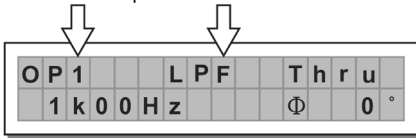

- **Hochpass-Filter**- Beim Hochpass-Filter werden alle Frequenzen über einem bestimmten Bereich weiterverarbeitet, alle anderen Frequenzen unterhalb dieses Bereichs werden abgeschnitten.

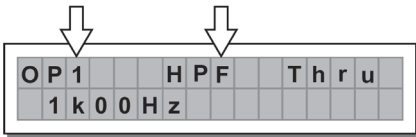

- **Trennfrequenz**- Passt die Cutoff-Frequenz an.

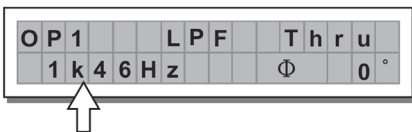

- **Phase**- Ermöglicht die Einstellung der Signalphase.

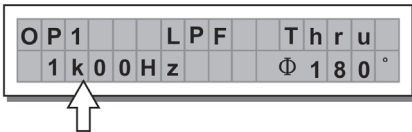

Hinweis: Nur im Fenster Tiefpass-Filter verfügbar.

Die Crossover-Werte können in folgenden Bereichen gesetzt werden:

XOVER					
	NAME	TYPE	SLOPE	FREQ	PHASE
LPF	Thru			15.6Hz ~ 16KHz	0° ~ 180° (Stp 5°)
	But	Butterworth	6, 12, 18, 24 dB/oct		
	Bes	Bessel	12, 18, 24 dB/oct		
	LR	Linkwitz-Riley	12, 24, 48 dB/oct		
HPF	Thru			15.6Hz ~ 16KHz	
	Hish 6	Butterworth	6, 12, 18, 24 dB/oct		
	Hish 12	Bessel	12, 18, 24 dB/oct		
	Notch	Linkwitz-Riley	12, 24, 48 dB/oct		

Ausgangs-Pol- Steuert die Polarität des Ausgangs. Hier können Sie die Phase des Signals auf einzelnen Ausgängen invertieren. Der Effekt arbeitet in 5 Stufen in einem Bereich zwischen 0 und 180. Auf diese Weise ist es möglich, die Phase jedes einzelnen Ausgangs in 5 Stufen in einem Radius von 360° einzustellen. Diese Funktion ist besonders bei der Montage von mehreren Lautsprecherboxen hilfreich, um die Interpolation zwischen verschiedenen Gehäusen oder zwischen Sektionen des gleichen Systems zu steuern.



Ausgangs-Limiter- Hält das Signal jedes individuellen Ausgangs innerhalb eines bestimmten Pegelwertes.



- **Reaktionszeiten-** Auswahl zwischen 3 Limiter-Reaktionsgeschwindigkeiten:
 - Schnell-** Für einen schnellen Limiter-Betrieb geeignet, wird normalerweise für Signale in hohen Frequenzbereichen verwendet.
 - Normal-** Eignet sich für die überwiegende Anzahl der Full-Range-Systeme und Anwendungen mit Signalen im mittleren Frequenzbereich.
 - Langsam-** Eignet sich, um starke Schwankungen in der Lautstärke zu verhindern und für Signale in niedrigen Frequenzbereichen.

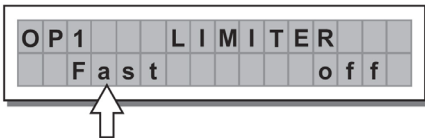

LIMITER	ATTACK	RELEASE
FAST	1 ms	10 ms
NORMAL	8 ms	80 ms
SLOW	45 ms	450 ms

- **Schwellenwert**- Setzt den Pegel fest, ab dem der Limiter aktiviert wird.

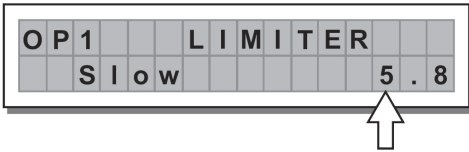

WICHTIG! Das Aktivieren des LIMITERS für einen bestimmten Ausgang ändert auch die Art und Weise, in der der Pegel auf der entsprechenden **LED** angezeigt wird. Der Pegel ist nun nicht mehr der "absolute" Ausgangspegel, sondern der Signalpegel -24dB, -12dB, -6dB im Vergleich zum **LIMITER-Schwellenwert** (durch orangefarbene **LIMIT-LED** angezeigt), egal wie hoch der Schwellenwert eingestellt ist.

OPTIONSMENÜ - Ermöglicht den Zugriff auf Systemoptionen wie die Einstellungen für Multimedia-Speicherkarten oder für den Schutz gegen versehentliche oder unbefugte Änderungen.

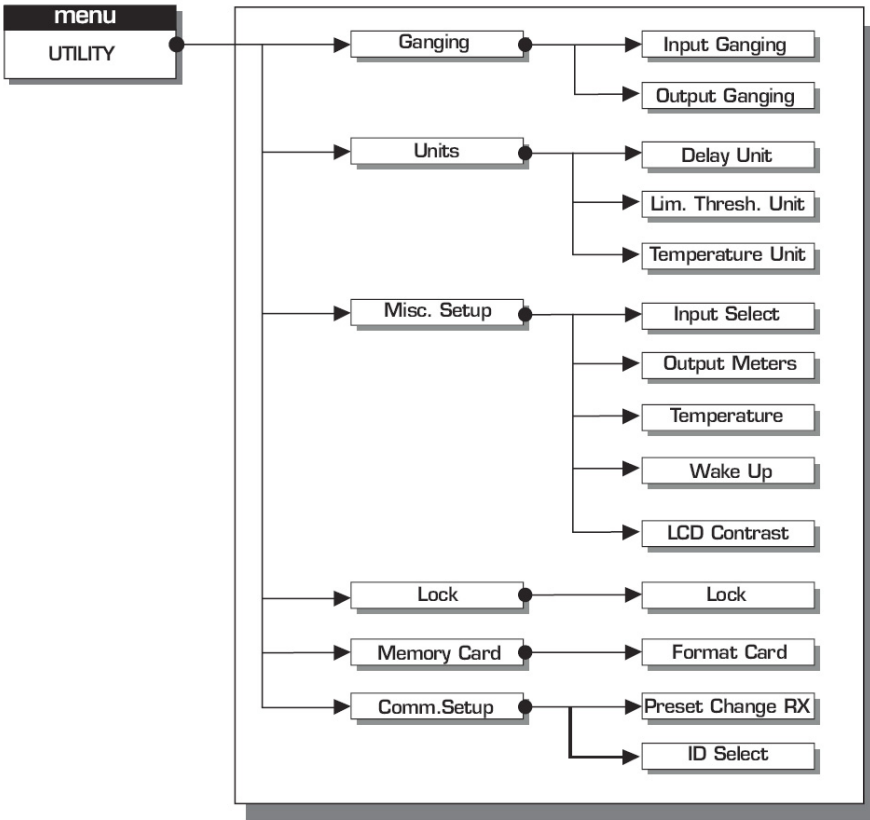

GRUPPIERUNGS-UNTERMENÜ- Ermöglicht die Gruppierung von Eingängen und/oder Ausgängen. Gruppierungen können zum Beispiel verwendet werden, um die rechten und linken Sektionen eines Stereo-Signals auf den gleichen Delay-Wert zu bringen oder mit nur einem Vorgang beide Eingänge mit dem EQ anzupassen, oder um identische Crossover-Parameter für verschiedene Ausgänge einzustellen, die an ein Stereo-Sound-System geleitet werden. Die Gruppierungsfunktion kann für Eingangsgruppen oder Ausgangsgruppen getrennt aktiviert werden.

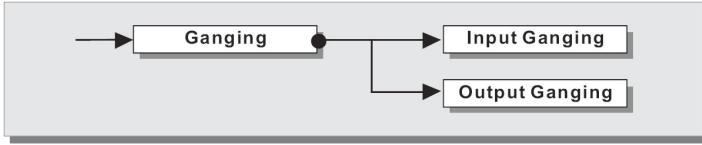

Input Ganging (Eingangsgruppierung)- Aktiviert/deaktiviert die Gruppierungsfunktion für Eingänge. Es gibt folgende Einstellungen:

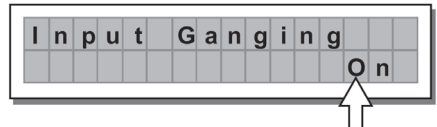
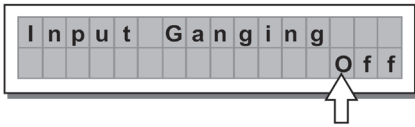

Output Ganging (Ausgangsgruppierung)- Aktiviert/deaktiviert die Gruppierungsfunktion für Ausgänge. Es gibt folgende Einstellungen:

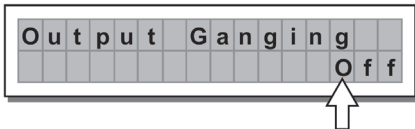

WICHTIG:

Sobald Eingänge und/oder Ausgänge gruppiert sind, zeigen die verschiedenen Menüseiten nur die Werte an, die tatsächlich verwendet werden können.

EINHEITEN-UNTERMENÜ

Wählen Sie die Einheiten, die für bestimmte Funktionen verwendet werden sollen.

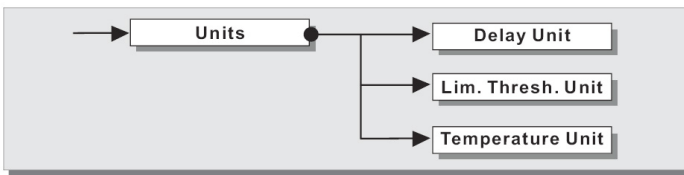

• **Delay Unit (Delay-Einheit)**- Legt die Einheit fest, in der Delays angegeben werden. Die Optionen umfassen: **m** = Meter - **mm** = Millimeter - **ms** = Millisekunden - **µs** = Mikrosekunden

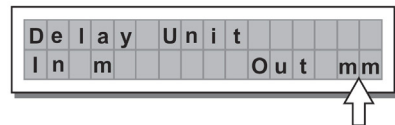
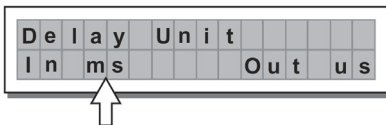

- **Lim. Thresh. Unit (Schwellenwerteinheit des Limiters)**- Legt die Einheit für den Schwellenwert des Limiters fest (Menü **BEARBEITEN** - Ausgang Limiter).

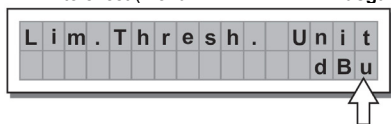

Die Optionen umfassen: **dBu** = Dezibel (0 dBu = 0,775 V rms) - **V** = Volt

- **Temperatureinheit**- Legt die Einheit für die Temperaturfunktion fest (Menü **OPTIONEN** - Setup-Untermenü für diverse Einstellungen). Die Optionen umfassen: **C** = Grad Celsius - **F** = Grad Fahrenheit

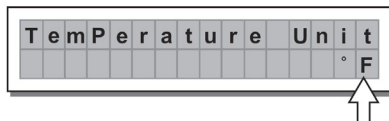
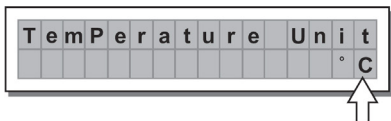

SETUP-UNTERMENÜ FÜR DIVERSE OPTIONEN- Zum Bearbeiten verschiedener Systemoptionen.

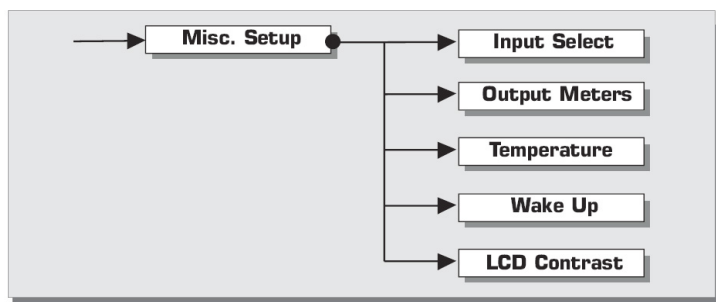

- **Input Select (Auswahl der Eingänge)**- Wählen Sie die digitalen oder analogen Eingänge aus, die STAGEDRIVE+ verwenden soll.

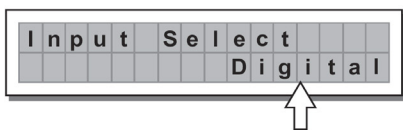

- **Output Meters (Ausgangspegelanzeige)**- Wählen Sie, ob das Ausgangssignal vor oder nach MUTE angezeigt werden soll.
Die Optionen umfassen:
PreMute (Vor der Stummschaltung)- Das Signal wird immer angezeigt, egal welcher MUTE-Status gerade aktuell ist
PostMute (nach der Stummschaltung)- Das Signal wird nur angezeigt, wenn der Ausgang nicht auf MUTE gestellt ist

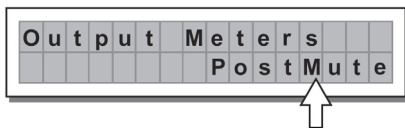
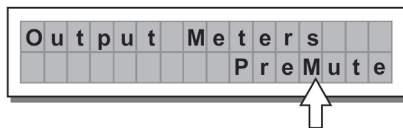

- **Temperatur-** Legt den Wert der Umgebungstemperatur am Montageort fest, um Unterschiede aufgrund von unterschiedlichen Geschwindigkeiten der Schallübertragung durch die Lufttemperatur zu kompensieren. Die Bearbeitungswerte bewegen sich in folgenden Bereichen: **+60 C ~ -30 C** in 1 C Schritten **140,0 F ~ -22,0 F** in 1,8 F Schritten

Hinweis: Mit der Funktion Temperatureinheit (Menü OPTIONEN - Untermenü Einheiten) kann zwischen C (Grad Celsius) und F (Grad Fahrenheit) gewählt werden.

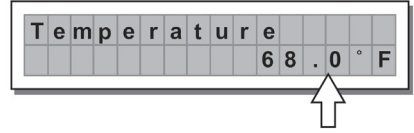
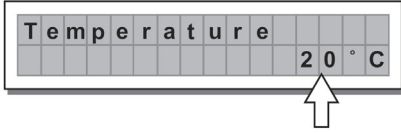

- **Wake Up (Wiederherstellen)-** Stellt den Modus ein, in dem die MUTE-Funktionen wiederhergestellt werden, wenn der STAGEDRIVE+ eingeschaltet wird.
Die Optionen umfassen:
Normal- Beim Einschalten stellt das System die MUTE-Konfiguration wieder her, die vor dem Ausschalten zuletzt verwendet wurde
Mute- Nach dem Einschalten setzt das System automatisch alle Ausgänge auf MUTE

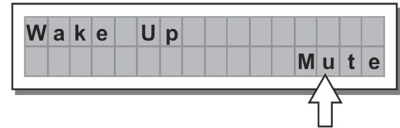
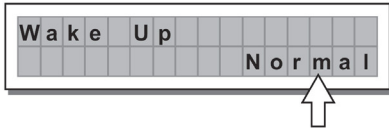

LCD Contrast (LCD-Kontrast)- Passt den Kontrast am Display an.

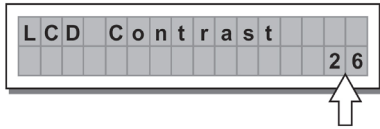

UNTERMENÜ SPERREN- Zum Aktivieren oder Deaktivieren der Sperrfunktion des Systems gegen versehentliche oder unbefugte Änderungen.

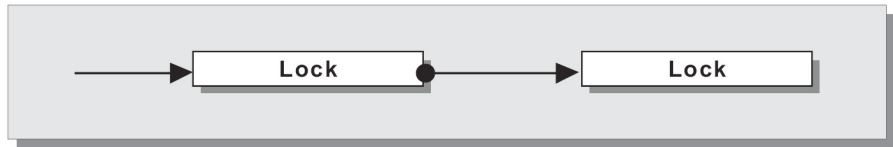

So aktivieren Sie den Schutz

1. Wählen Sie einen Schutzmodus aus (teilweise oder komplett).
2. Mit ◀ und ▶ gelangen Sie zum Bereich, in dem das **Password** eingegeben wird.
3. Das Passwort kann aus vier alphanumerischen Zeichen bestehen, die Sie mit den Tasten ◀ und ▶ erreichen und mit dem **DATENRAD** editieren können.
4. Nach Eingabe des Passwortes drücken Sie **ENTER**.

Hinweis: Die Bestätigung wird nur akzeptiert, wenn der Cursor auf einem der vier Passwortzeichen steht. So wird verhindert, dass versehentlich eine Sperre aktiviert wird ohne das Kennwort gesehen zu haben.

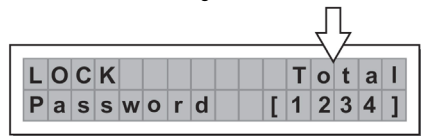
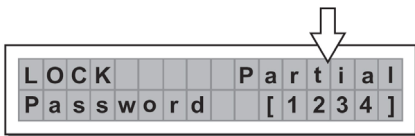

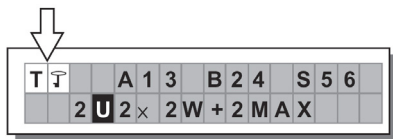
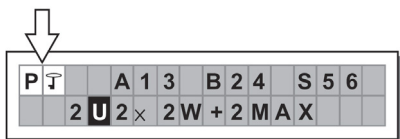

Deaktivieren der Sperre

1. Navigieren Sie zum Untermenü **SPERREN**.
2. Sie werden aufgefordert, Ihr Passwort einzugeben, um die Sperre aufzuheben.
3. Geben Sie das **Passwort** über die Tasten ◀ und ▶ und über das **DATENRAD** ein und drücken Sie dann **ENTER**.

Hinweis: Falls Sie das falsche Passwort eingeben, werden Sie erneut um die Eingabe gebeten. Alle Zeichen werden dabei verschlüsselt dargestellt.

WICHTIG! Wenn Sie sich nicht an das Passwort erinnern, halten Sie **"ZURÜCK"** und **"◀"** gedrückt und schalten das Gerät ein. Damit wird die Sperre aufgehoben.

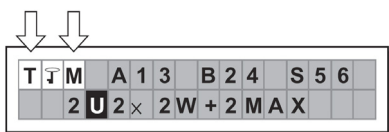

Hinweis: Neben dem Symbol für kompletten oder teilweisen Schutz, kann der Buchstabe "M" aufscheinen. Dies bedeutet, dass das System geschützt ist, aber das betreffende PRESET modifiziert und noch nicht gespeichert wurde. Sie können das System jedoch problemlos ein- und ausschalten, da die aktuellen Einstellungen im Puffer gespeichert sind. Falls dies jedoch Ihr primäres Setup ist, wäre es ratsam, es als PRESET abzuspeichern.

UNTERMENÜ SPEICHERKARTE- Ermöglicht das Formatieren (Löschen) der Multimedia-Speicherkarte. Eine Karte muss zuerst vom Gerät formatiert werden, um sie im System verwenden zu können.

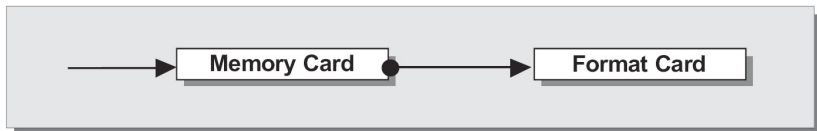

So formatieren Sie die Karte

1. Schieben Sie eine Multimedia-Speicherkarte in den Steckplatz.
2. Im Untermenü Speicherkarte drücken Sie **ENTER**
3. Drücken Sie erneut **ENTER**, um die Formatierung zu starten.
4. Das System formatiert die Karte und meldet den Abschluss des Vorgangs.



Hinweis: Bei Fehlern, Kartendefekten, oder falls sich keine Karte im Steckplatz befindet oder die Karte während der Formatierung entfernt wird, zeigt das Display folgende Meldung an:



Während der Formatierung speichert das System das *Standard*-PRESET automatisch in alle 128 CARD-Speicherstellen.

Hinweis: Da das System immer konfiguriert werden muss, gibt es keine leeren Speicherstellen. Alle Anwender- und Kartenspeicherstellen, in denen noch keine Anwenderdaten gespeichert wurden, werden automatisch vom *Standard*-PRESET belegt, das eine Standard-Konfiguration besitzt, bei der alle Parameterwerte auf Null stehen.

UNTERMENÜ KOMM.-SETUP

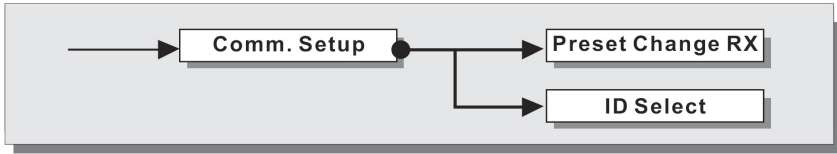

Dieses Untermenü ermöglicht den Zugriff auf die Einstellung für die Kommunikation mit anderen Geräten über die RS485-Ports.

Hinweis: Die Funktionen "Dump Out Preset" ("Preset auslesen") und "Incoming Dump" ("Eingehende Daten auslesen") bilden Ausnahmen, da sie direkt vom PRESET-Menü gesteuert werden.

PRESET-Wechsel empfangen

Sie können PRESET-Wechselbefehle, die über einen USB-Anschluss oder ein anderes STAGEDRIVE+ geschickt wurden, annehmen oder ignorieren, wenn es ein PRESET lädt. Es gibt folgende Einstellungen:

- Empfangene PRESET-Wechselbefehle ignorieren.
- PRESET-Wechselbefehle akzeptieren und ausführen.

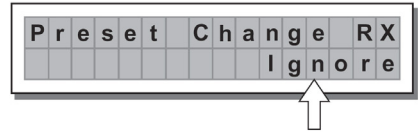
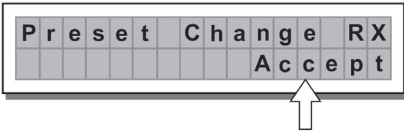

INSTALLATION DES SOFTWARETREIBERS

1. Legen Sie die inkludierte Software-CD in das CD-Laufwerk Ihres Computers ein.
2. Navigieren Sie zum Ordner MaxiDrive3.4 DPA Software/USB-Treiber und suchen und installieren Sie die "PL-2303-Treiber Installer.exe" für Ihre Windows-Version.
3. Sobald der Treiber installiert ist, schalten Sie STAGEDRIVE+ ein und verbinden den USB-Port des STAGEDRIVE+ via USB-Kabel mit dem USB-Port des PC.
4. Klicken Sie mit der rechten Maustaste auf **ARBEITSPLATZ** und dann auf **EIGENSCHAFTEN**
5. Klicken Sie auf die Registerkarte **HARDWARE** und wählen **GERÄTE-MANAGER**.
6. Doppelklicken Sie auf **ANSCHLÜSSE (COM & LPT)** und suchen nach **PROLIFIC USB-to-SERIAL Com Port**.
7. Doppelklicken Sie auf **PROLIFIC USB-to-SERIAL Com Port**, **PORT-EINSTELLUNGEN** und dann **ERWEITERT**.
8. Ändern Sie die **COM PORT NUMMER** auf **COM1** (oder einen anderen COM-Port, der nicht verwendet wird) und klicken Sie auf OK.

SOFTWARE-SETUP

Der Software-Editor kann wie folgt aufgebaut sein:

1. Starten Sie das Software-Editor-Programm sobald die Software-Treiber installiert sind (STAGEDRIVE+ muss dabei eingeschaltet und via USB mit dem Computer verbunden sein).
2. Wählen Sie **New** (Neu).

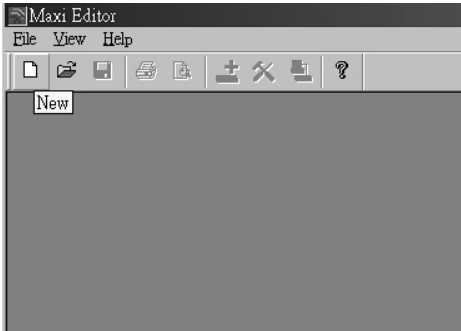

3. Wählen Sie Ihr Interface aus der Liste aus.
4. Wählen Sie **Network Scan** (Netzwerk-Scan).

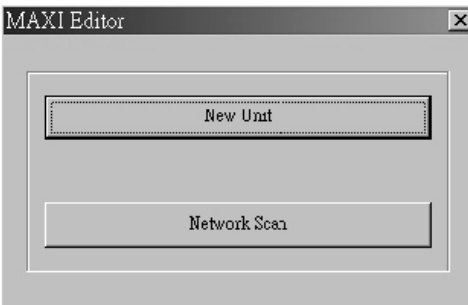

5. Wenn der Netzwerk-Scan fehlschlägt, überprüfen Sie die **Geräte-ID**. Wählen Sie **New Unit** (Neue Einheit) und selektieren das Interface. Vergewissern Sie sich, dass die STAGEDRIVE+ ID-Nummer 1 ist oder der Geräte-ID entspricht.
6. Wählen Sie **OK**, um ins nächste Interface zu gelangen:

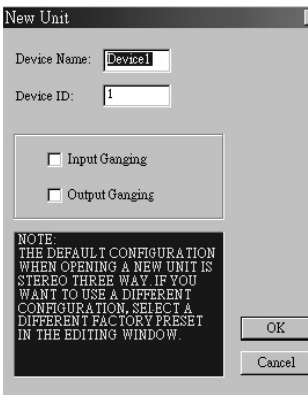

7. Wählen Sie das Symbol **Optionen**, um ins nächste Interface zu gelangen:

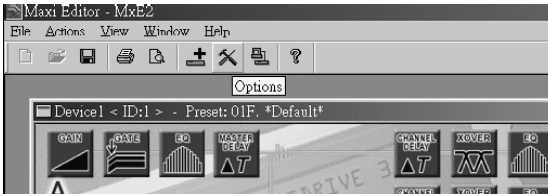

8. Wählen Sie **Rs232** mit der COM-Einstellung, die Sie während des Software-Treiber-Setup für den Port ausgewählt haben, und 38400 (oder 19200) als Baud-Rate.
HINWEIS: Achten Sie darauf, dass die Einstellungen am Computer den Einstellungen am STAGEDRIVE+ entsprechen.

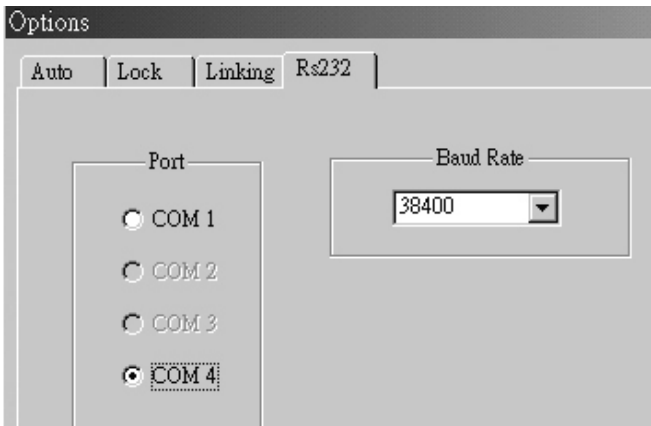

9. Wählen Sie die On-/Off-Linie im Haupt-Interface nachdem Sie **OK** gewählt haben.

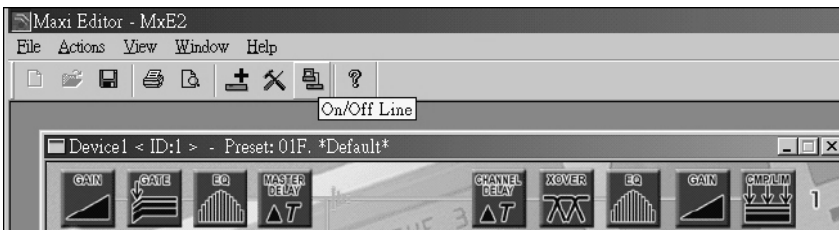

10. Das Interface wird angezeigt. Wählen Sie **OK** und die Verbindung zur Anlage wird hergestellt.

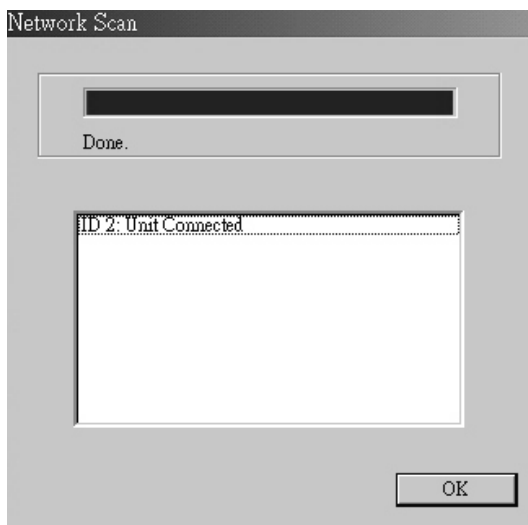

11. Wenn die Verbindung hergestellt ist, erscheint ONLINE.

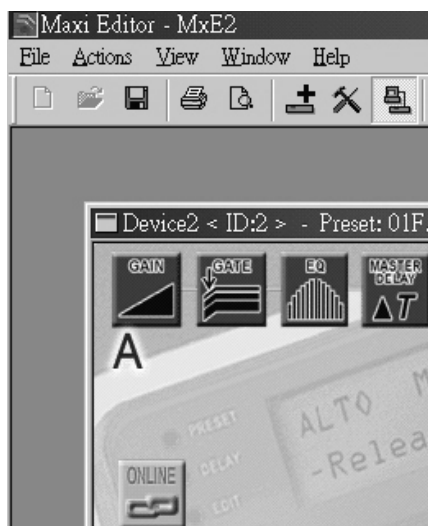

ANSCHLUSSBEISPIELE

Die folgenden Beispiele sollen Ihnen helfen, STAGEDRIVE+ anzuschließen und zu verwenden.
A13 B24 S56 2-WEGE-STEREO + 2 MONO AUX [2 2W +2 MAX]

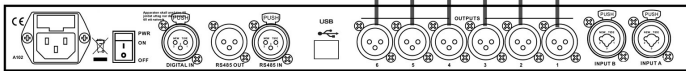
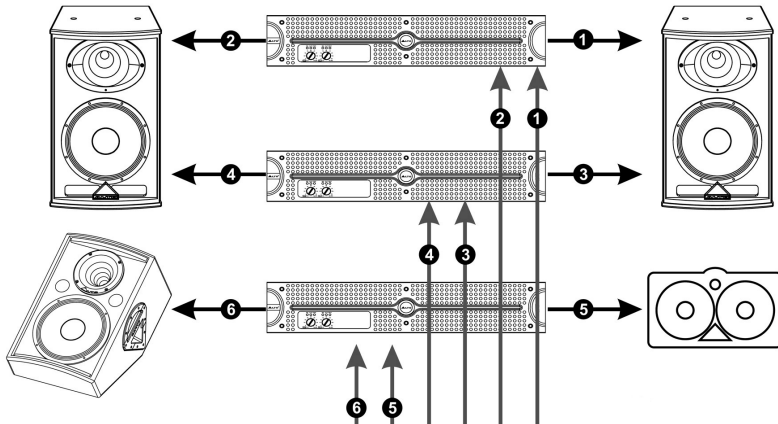
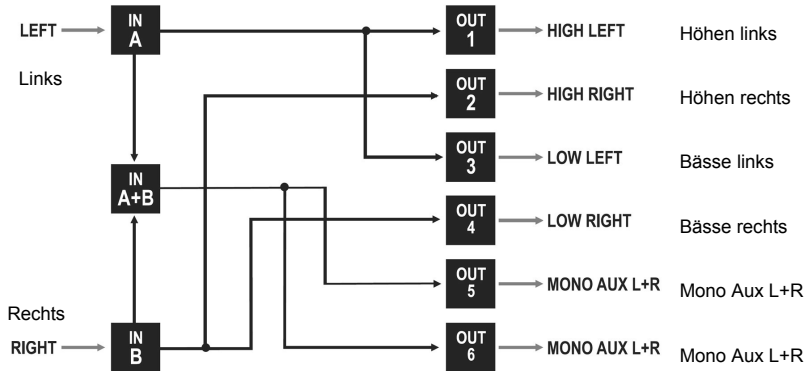

STAGEDRIVE+

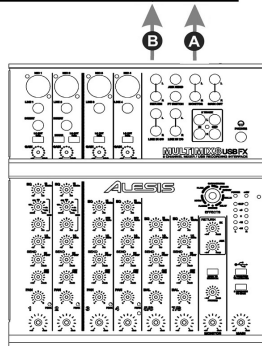
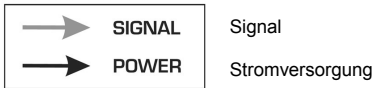

A135 B246 3-WEGE-STEREO [2x3W]

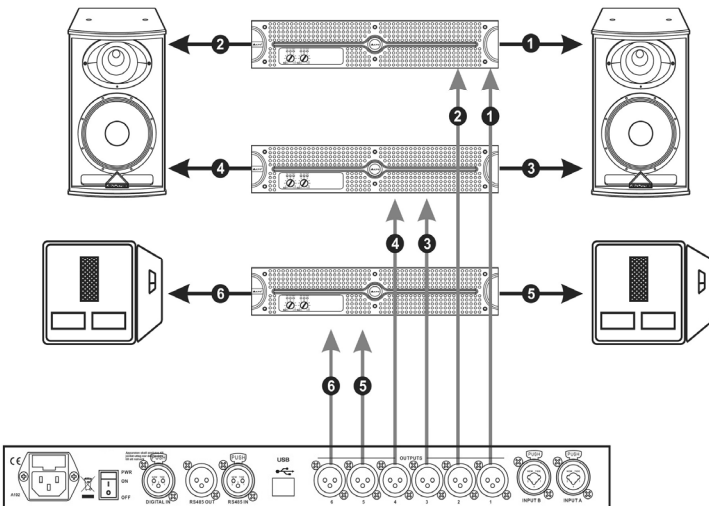
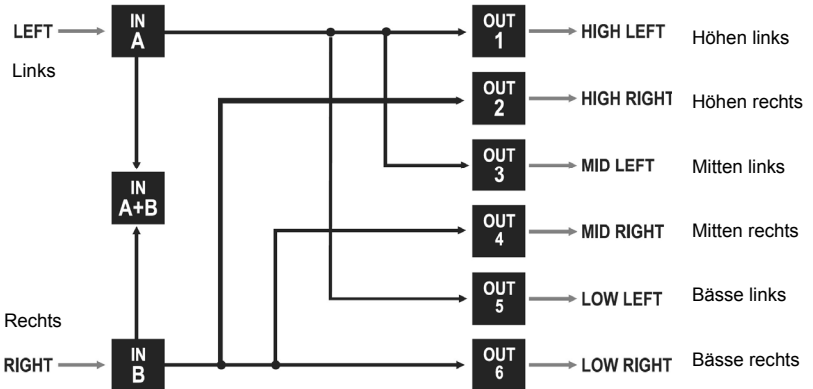

STAGEDRIVE+



Signal
 Stromversorgung

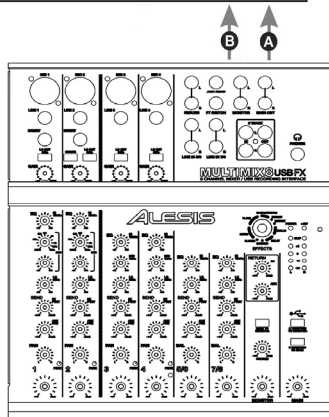

A13 B24 S56 3-WEGE-STEREO mit MONO SUB + MONO AUX [2 3W + MSB + MAX]

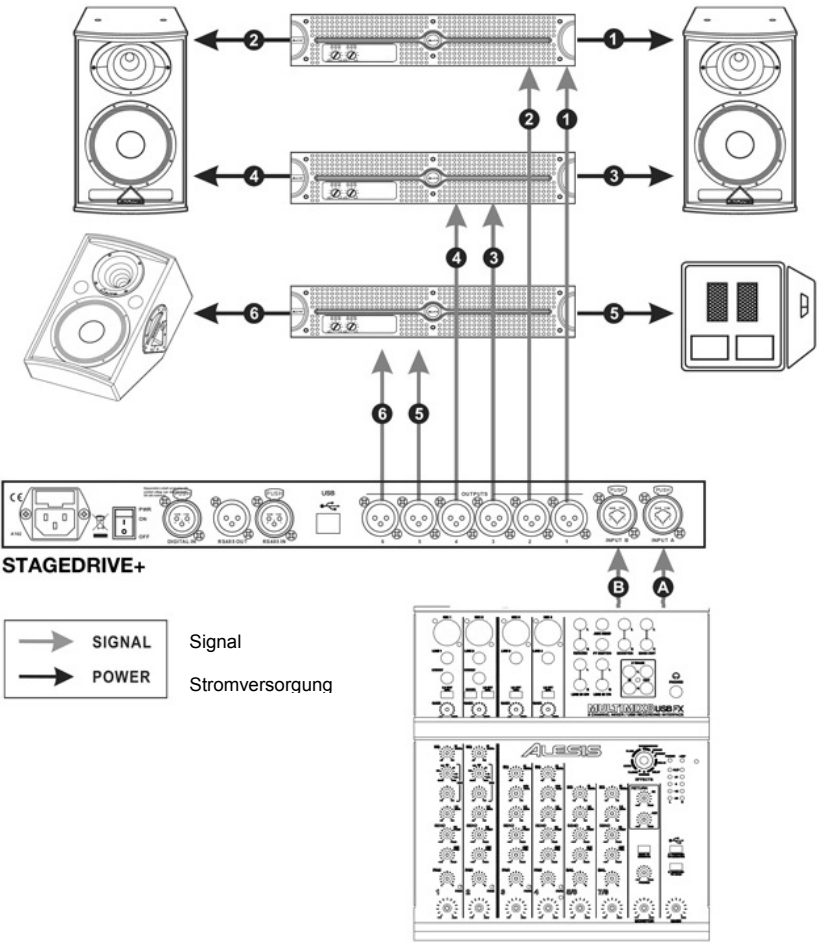

A1324 S56 4-WEGE 4 MONO + 2 MONO AUX [4W +2 MAX]

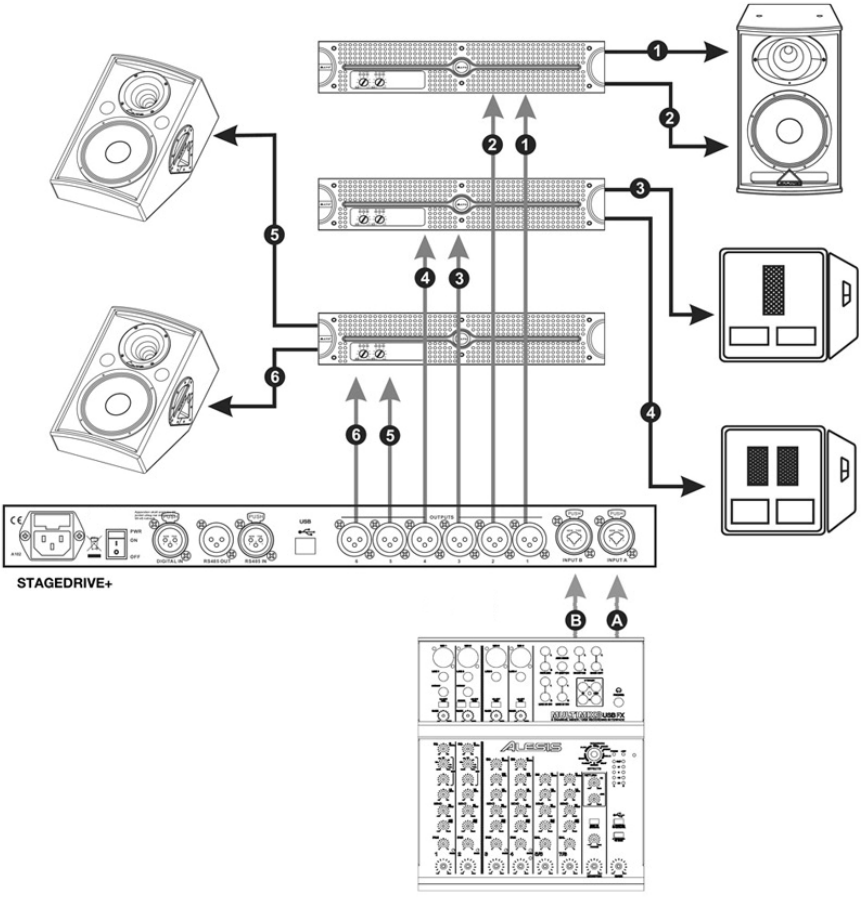
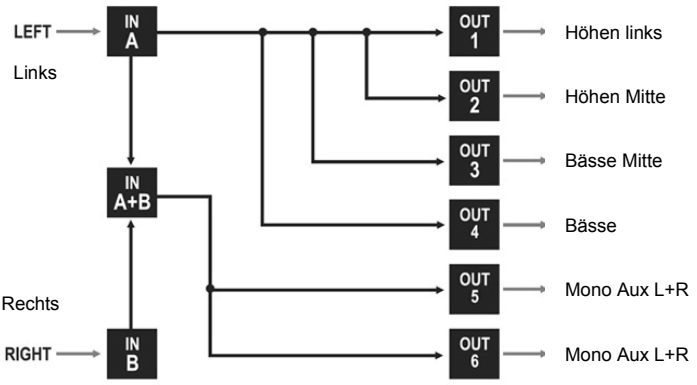

A135 B246 3-WEGE-STEREO [2x3W]

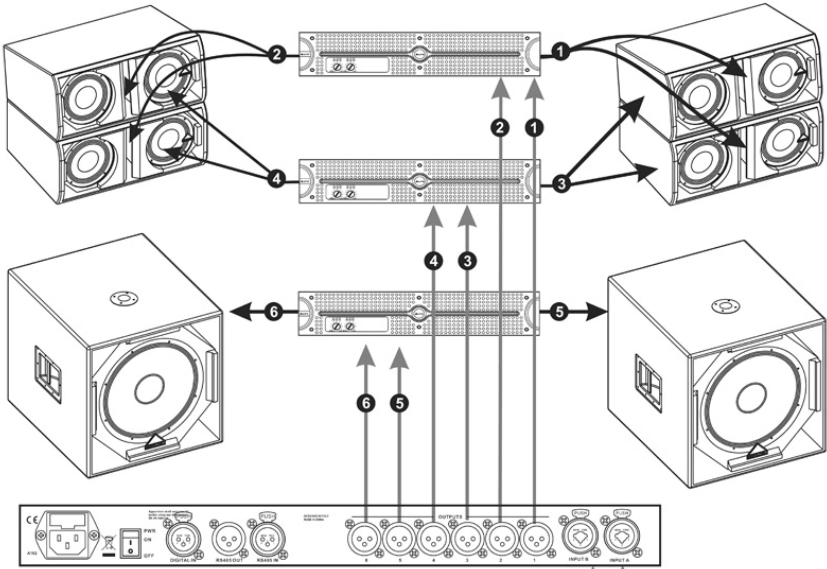
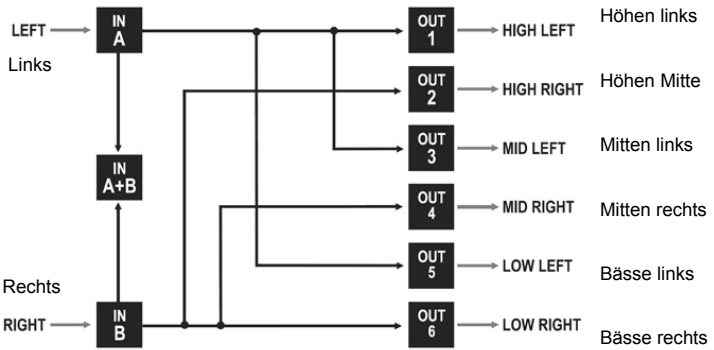

STAGEDRIVE+

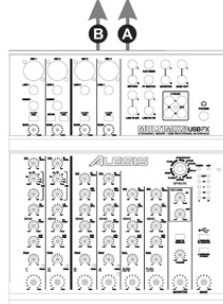

SNELSTARTGIDS (NEDERLANDS)

INHOUD VAN DE DOOS

STAGEDRIVE+
Stroomkabel
Software-cd
Snelstartgids
Informatieboekje Veiligheid en Garantie

SNELLE OPSTELLING

- Zorg ervoor dat alle artikelen, opgesomd in INHOUD VAN DE DOOS, zich in de doos bevinden.
- LEES HET INFORMATIEBOEKJE VEILIGHEID EN GARANTIE VOORALEER HET PRODUCT TE GEBRUIKEN.**
- Bestudeer het aansluitschema in deze handleiding.
- Plaats alle apparaten op een geschikte plaats voor het in werking stellen.
- Zorg ervoor dat alle apparaten zijn uitgeschakeld en alle faders en gain-knoppen zijn ingesteld op "nul".
- Sluit alle uitgangen van de geluidsbronnen naar de versterkingangen aan zoals aangegeven in het schema.
- Sluit de versterkeruitgangen aan op de luidsprekers.
- Sluit alle apparaten aan op een geschikte stroombron.
- Zet alles aan in deze volgorde:
 - Geluidsbronnen (zoals microfoons, draaitafels, cd-spelers, enz.)
 - Mengpaneel
 - Versterker
 - Luidsprekers
- Zet bij het uitzetten alles uit in deze volgorde:
 - Luidsprekers
 - Versterker
 - Mengpaneel
 - Geluidsbronnen

SCHEMA VAN HET VOORPANEEL

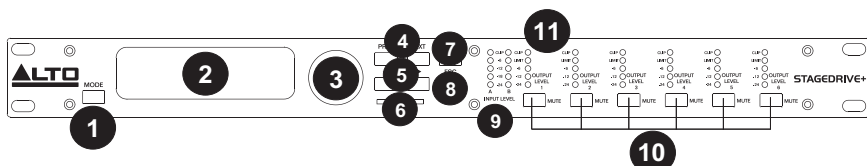

- MODE-KNOP:** selecteer één van de vier modi: PRESET (VOORINSTELLING), DELAY (ECHO), EDIT (BEWERKEN) and UTILITY (SYSTEEMOPTIES).
- SCHERM:** toont de pagina's van de verschillende menu's en hun parameters.
- DRAAIKNOOP:** bewerkt de waarde van de geselecteerde parameter.
- KNOP VORIGE/VOLGENDE:** geeft toegang tot menupagina's en/of -parameters.
- CURSORTOETS EN NAVIGATIE:** selecteert verschillende parameters.
- GEHEUGENKAARTSLEUF:** MMC-kaartsleuf om VOORINSTELLINGEN in op te slaan.
- ENTERTOETS:** bevestigt de bewerking van parameters.
- ESCAPETOETS:** verlaat de geselecteerde bewerkingspagina of annuleert een bewerking.
- LEDS INGANGNIVEAU:** geeft het A/B-ingangniveau weer.
- DEMPINGSSCHAKELAARS:** dempen het signaal van een van de zes overeenkomstige uitgangen.
- LEDS UITGANGNIVEAU:** geven het uitgangniveau weer.

Opmerking: De LIMITER (BEGRENZER) verandert de manier waarop het uitgangsniveau wordt weergegeven op de bijbehorende LED. Het niveau weergegeven op de meter is niet langer het "absolute" uitgangsniveau, maar het niveau van het signaal op -24dB, -12dB, -6dB in vergelijking met de limiterdrempel (aangegeven door de oranje LIMIT LED).

SCHEMA VAN HET ACHTERPANEEL

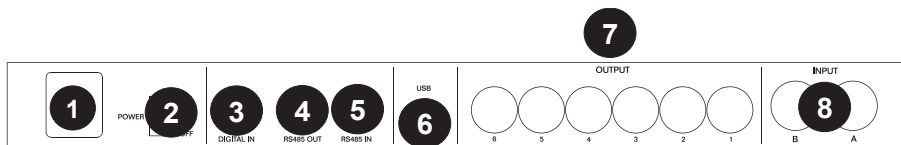

- WISSELSTROOMINGANG EN ZEKERINGHOUDER:** sluit hier de meegeleverde stroomkabel aan.
OPGELET: Als de zekering vervangen moet worden, verwijzen wij u naar een gekwalificeerde technicus. Als de zekering blijft overslaan na vervanging, gebruik dit apparaat dan niet langer en laat het repareren door een deskundige.
- STROOMSCHAKELAAR:** zet de stroomtoevoer aan en uit.
- DIGITALE INGANG:** sluit hier een gebalanceerde XLR-F-kabel op aan.
- RS485-UITGANG:** maakt uitgaande communicatie mogelijk tussen een STAGEDRIVE+ en andere STAGEDRIVE+-apparaten.
- RS485-INGANG:** maakt binnenkomende communicatie mogelijk tussen een STAGEDRIVE+ en andere STAGEDRIVE+-apparaten.
- USB-POORT:** maakt communicatie via pc mogelijk.
- UITGANGEN:** gebruik gebalanceerde XLR-M-kabels op deze uitgangen.
- INGANGEN:** gebalanceerde gecombineerde XLR- $\frac{1}{4}$ "-ingangen.

AAN DE SLAG

Aanpassen van het ingangssignaal

- Houd de STAGEDRIVE+ uitgangen in **MUTE (GEDEMP)**-status (LED's aan) door te drukken op de respectievelijke mute (dempen)-knop op het voorpaneel.
- Stuur een signaal naar de ingang van de STAGEDRIVE+ en kijk naar de LED-meter **INPUT LEVEL A-B (INGANGSNIVEAU A-B)**.
- Houd het signaal hoog, maar zonder de **CLIP-LED** continu te activeren. Pas indien nodig de ingangsversterking aan.
- Druk op de **MODE (MODUS)**-toets tot de LED van het menu **EDIT (BEWERKEN)** oplicht. Gebruik de toetsen **PREV (VORIGE)** en **NEXT (VOLGENDE)** om naar de pagina **Input gain (Ingangsversterking)** te navigeren en druk daarna op **ENTER**.
- Gebruik de **DIAL (DRAAIKNOP)** op de versterkingswaarde aan te passen en controleer het signaalniveau op de LED-meter tot u ideale waarden bereikt.
- Gebruik de toetsen **PREV** en **NEXT** om te navigeren naar de pagina **INB Gain**.

MENU'S

Het menu PRESET (VOORINSTELLING)

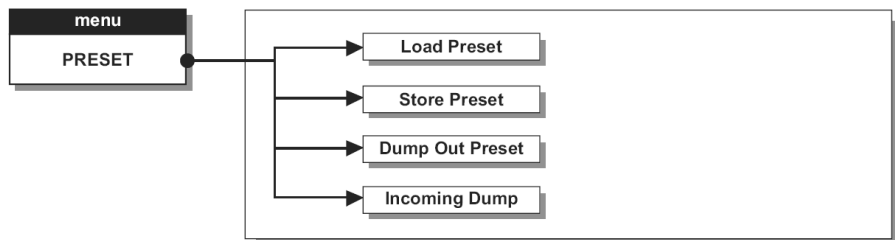

Soorten VOORINSTELLINGEN

Er zijn 3 categorieën van VOORINSTELLINGEN:

- **F** = fabrieksvoorinstellingen die niet permanent kunnen worden gewijzigd. Dit zijn de uitgangspunten voor het vanaf nul aanmaken van GEBRUIKERSVOORINSTELLINGEN en KAARTVOORINSTELLINGEN.
- **U** = GEBRUIKERSVOORINSTELLINGEN kunnen worden geprogrammeerd door gebruikers.
- **C** = KAARTVOORINSTELLINGEN kunnen worden geprogrammeerd door gebruikers en opgeslagen op een Multimedia Memory Card.

Een VOORINSTELLING laden:

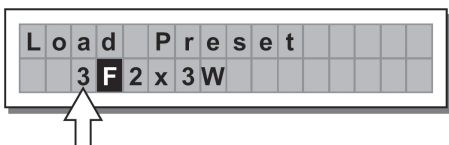

- Gebruik de DRAAIKNOOP om een Fabrieksvoorinstelling (aangegeven met de letter F) te selecteren en druk op ENTER om de voorinstelling in het geheugen te laden.

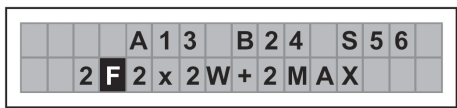

Aanpassen van de ingangsversterking



1. Houd de STAGEDRIVE+ uitgangen in MUTE (GEDEMPT)-status (LED's aan).
2. Stuur een signaal naar de ingang van de STAGEDRIVE+ en kijk naar de LED-meter.
3. Voor het verkrijgen van een goed signaalniveau zorgt u ervoor dat de rode INPUT LEVEL AB CLIP (CLIPPING INGANGSNIVEAU AB)-LED niet de hele tijd oplicht.
4. Kom de instelling te weten van het uitgangsniveau van uw mengpaneel (of ander apparaat) en sluit hem aan op de ingang van de STAGEDRIVE+.
5. Pas de ingangsversterking van de STAGEDRIVE+ aan door op de MODE (MODUS)-toets te drukken tot de LED van het menu EDIT (BEWERKEN) oplicht.
6. Gebruik de toetsen PREV (VORIGE) en NEXT (VOLGENDE) om naar de pagina Input gain (Ingangsversterking) te navigeren:
7. Druk op ENTER. Het display toont de pagina's IN A GAIN of IN A&B GAIN pagina (afhankelijk van de configuratie en andere hulpprogramma's die in het geheugen zijn geladen):
8. Gebruik de DRAAIKNOOP om de versterkingswaarde aan te passen en controleer het signaalniveau op de LED-meter tot u ideale waarden bereikt. Gebruik dan de toetsen PREV en NEXT om de pagina IN B GAIN te bekijken (als er een is, wat afhangt van de configuratie en de andere hulpprogramma's, geladen in het geheugen).

Een VOORINSTELLING opslaan:

1. Gebruik de DRAAIKNOOP om een gebied te selecteren waarin de VOORINSTELLING moet opgeslagen worden en druk op ENTER.
2. Gebruik de toetsen ◀ en ▶ om de cursor op een karakter te plaatsen en de DRAAIKNOOP om de alfanumerieke waarde in te voeren.
3. Bewerk indien gewenst de naam van de VOORINSTELLING en druk op ENTER om de wijzigingen op te slaan of druk op ESC om af te breken.

P	r	e	s	e	t	N	a	m	i	n		
[2	x	2	W	+	2	M	A	X]		

SUBMENU COMM. SETUP: dit submenu biedt toegang tot het instellen van de communicatie via de USB-poort met andere apparaten. **Opmerking:** De functies Dump Out Preset (Voorinstelling versturen) en Incoming Dump (Binnenkomende gegevensdump) zijn een uitzondering, omdat ze direct worden bestuurd vanuit het menu PRESET (VOORINSTELLING).

Transmit PRESETS (VOORINSTELLINGEN versturen): gebruik dit menu om VOORINSTELLINGEN via de RS485-poort te versturen om VOORINSTELLINGEN te kopiëren naar een andere STAGEDRIVE+.

Een VOORINSTELLING downloaden: selecteer een VOORINSTELLING met behulp van de DRAAIKNOP en druk op ENTER.

Opmerking: De menupagina blijft ongewijzigd, zodat andere VOORINSTELLINGEN verstuurd kunnen worden.

Alle gegevens van de voorinstellingen (naam, configuratie, parameterwaarden, enz.) worden onmiddellijk verstuurd naar de apparaten die aangesloten zijn op de RS485-poort.

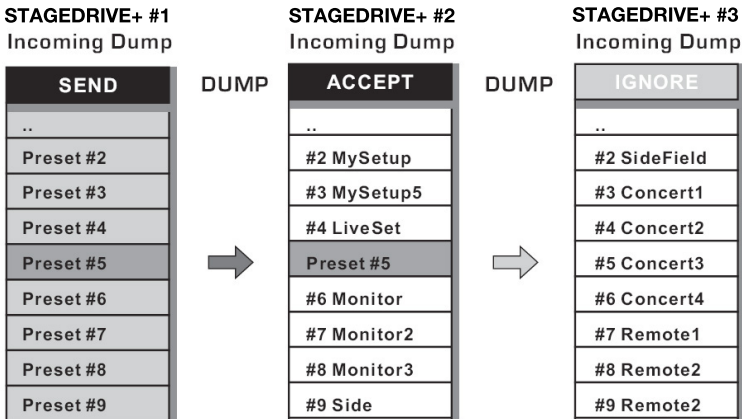

Opmerking: De ontvangende apparaten moeten inkomende dumpoperaties kunnen identificeren en accepteren om de overdracht te doen werken. Wanneer twee of meer STAGEDRIVE+-apparaten zijn aangesloten, overschrijft de VOORINSTELLING, verstuurd door de verzendende STAGEDRIVE+, de bestaande VOORINSTELLING in dezelfde geheugenpositie van de ontvangende STAGEDRIVE+.

D	u	m		O	u	t		P	r	e	s	e	t
	2	U		x	2	W	+	2	M	A	X		

Incoming Dump (Inkomende gegevensdump)
Aanvaardt of negeert het dumpen van een VOORINSTELLING verzonden vanaf een andere STAGEDRIVE+ via de RS485-poort of vanaf een computer via USB. De poortinstellingen kunnen de volgende zijn:

- De verzonden gegevens negeren
- De verzonden gegevens accepteren

I	n	c	o	m	i	n	g		D	u	m			
									I	g	n	o	r	e

I	n	c	o	m	i	n	g		D	u	m			
									A	c	c	e	p	t

Systembeveiliging

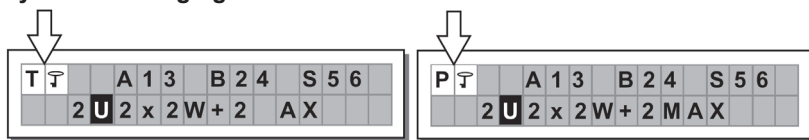

Deze aanduidingen verschijnen wanneer de **LOCK (VERGRENDDELINGS)**-functie is ingeschakeld, (als de LOCK UTILITY (VERGRENDDELINGSTOEPASSING) van het systeem volledig (T) of gedeeltelijk (P) beschermd is tegen toevallige of ongeoorloofde wijzigingen). De beveiliging wordt ingesteld met behulp van een wachtwoord. Zonder dit wachtwoord kunnen geen bewerkingen worden uitgevoerd.

HET MENU DELAY (VERTRAGING)

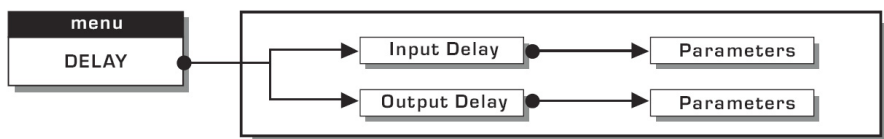

Input Delay (Ingangsvertraging): Vertraagt het signaal van een ingang (of van een som van ingangen) voor het naar het routingstelsysteem te versturen. Alle uitgangen worden vertraagd met dezelfde tijd. Dat wordt vaak gedaan om te compenseren voor afstanden tussen luidsprekerboxen of in grote zalen.

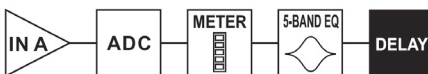
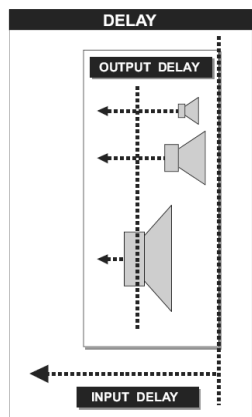

Ingang A ► Analooq-digitaalozmetter ► LED-meter ► 5-bands EQ ► Delay

De waarden voor ingangsvertraging kunnen worden ingesteld binnen de volgende bereiken:

INPUT DELAY		
unit	range	step
m	0.0 ~ 900.0	0.5
mm	0 ~ 900000	7
ms	0 ~ 2621	1
us	0 ~ 2621438	21

De meeteenheid kan worden geselecteerd met de functie Delay Unit (Vertragingseenheid) (in het menu UTILITY, submenu Units (Eenheden)).

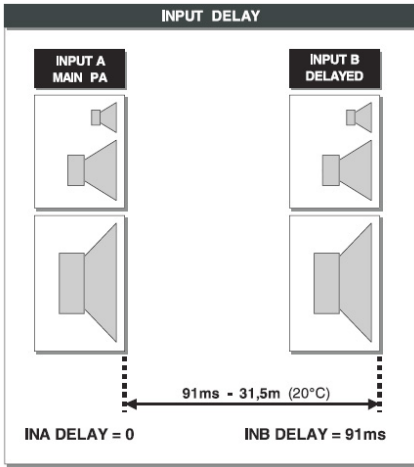

- **Output Delay (Uitgangsvertraging):** Vertraag het signaal enkel voor een bepaalde uitgang. Dit wordt gebruikt om de afstand te compenseren tussen verschillende luidsprekers in hetzelfde geluidssysteem (luidsprekerclusters) of om de interne afstemming van de luidsprekerboxcomponenten te corrigeren.

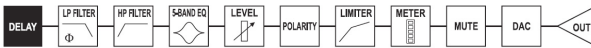
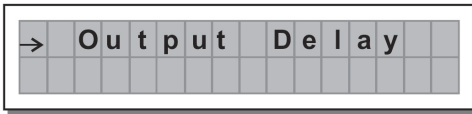

Vertraging ▶ Laagdoorlaatfilter ▶ Hoogdoorlaatfilter ▶ 5-bands EQ ▶ Niveau ▶ Polariteit ▶ Limiter ▶ LED-meter ▶ Dempen ▶ Digitaal-analoogomzetter ▶ Uitgang

De waarden voor uitgangsvertraging kunnen worden ingesteld binnen de volgende bereiken:

OUTPUT DELAY		
unit	range	step
m	0.0 ~ 100.0	0.5
mm	0 ~ 100000	7
ms	0 ~ 291	1
us	0 ~ 291271	21

De waarden voor uitgangsvertraging kunnen worden ingesteld binnen de volgende bereiken:

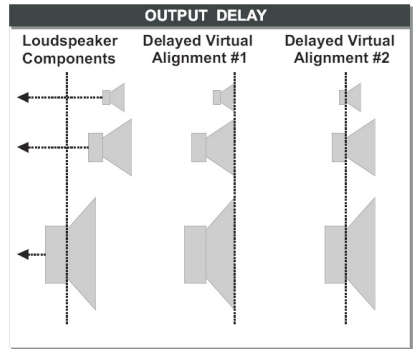
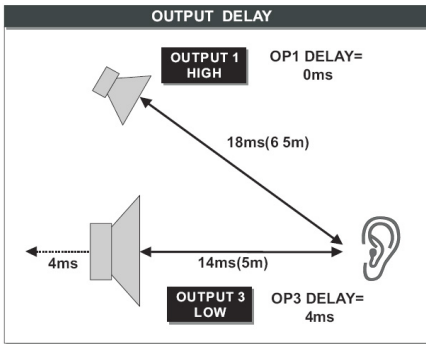

HET MENU EDIT (BEWERKEN)

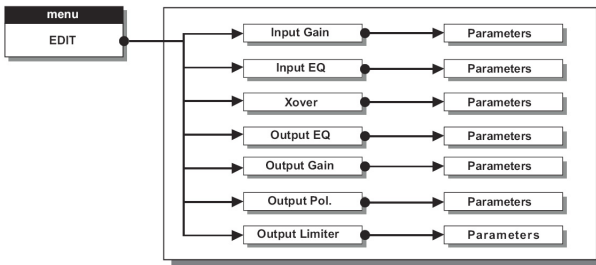

Input Noise Gate (Noisegate op de ingang): reduceert het achtergrondgeluid gegenereerd door een apparaat, aangesloten op de ingangen van de processor (bv. een mengpaneel). Het filter wordt actief wanneer het ingangssignaal zich onder een bepaalde drempel bevindt en van niveau verlaagt, door het verwijderen van ongewenste achtergrondgeluiden.

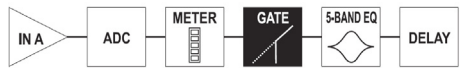

Ingang A ► Analoog-digitaalomzetter ► LED-meter ► Noisegate ► 5-bands EQ ► Vertraging

De volgende bewerkbare instellingen zijn beschikbaar, op twee verschillende pagina's:

a. Noise Gate ON/OFF (Noisegate AAN/UIT)

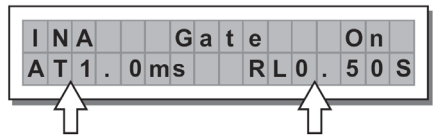
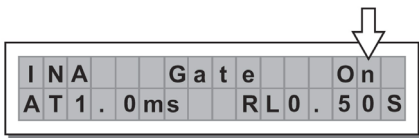

b. Reaction times (Reactietijden) - Stelt op de noisegate de tijden in voor attack en release.

- **ATTACK (AT):** De tijd die het filter nodig heeft om het signaal terug naar zijn normale niveau te brengen wanneer het de drempel overschrijdt.
- **RELEASE (RL):** De tijd die het filter nodig heeft om het signaal af te snijden van zodra het onder de drempel komt.

Threshold (Drempel): Als het signaal onder het drempelniveau komt, reduceert de noisegate het signaal. De bewerkbare waarden bevinden zich in het volgende bereik: +8dBu -60dBu, met stappen van 2dBu.

Range (Bereik): stelt de hoeveelheid in waarmee het signaalniveau wordt gereduceerd. De bewerkbare waarden bevinden zich in het volgende bereik: 0dBu -80dBu, met variabele stappen.

I	N	A				G	a	t	e			O	n	
T	H	R	-	6	0	.	0	R	G	-	8	0	.	0

Input/Output EQ (EQ op ingang/uitgang): Parametrische EQ-filters met vijf banden.Laat u toe de algehele toon van het signaal te veranderen.

>	I	n	p	u	t	E	Q							
---	---	---	---	---	---	---	---	--	--	--	--	--	--	--

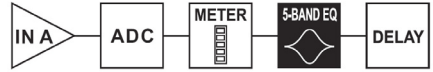

Ingang A ▶ Analogue-digitaalomzetter ▶ LED-meter ▶ 5-bands EQ ▶ Vertraging

>	O	u	t	p	u	t	E	Q						
---	---	---	---	---	---	---	---	---	--	--	--	--	--	--



Vertraging ▶ Laagdoorlaatfilter ▶ Hoogdoorlaatfilter ▶ 5-bands EQ ▶ Niveau ▶ Polariteit ▶ Limiter ▶ LED-meter ▶ Dempen ▶ Digitaal-analoogomzetter ▶ Uitgang

Voor elk filter zijn de volgende bewerkbare instellingen beschikbaar:

- **Type of filter (Type filter):** selecteer of het een piekfilter betreft, een laag of hoog hellingsfilter met een hellingsgraad van 6 of 12 dB per octaaf, of een bandsperfilter.

I	N	A				E	Q	1			P	e	a	k
2	k	0	0			1	.	0			-	5	.	0

Piekcurve

hellingscurve op laag

hellingscurve op hoog

bandsperfilter

Peaking

Low Shelving

High Shelving

Notch

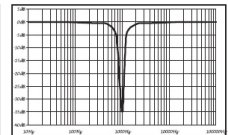
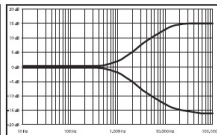
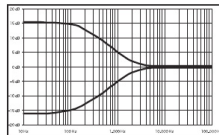
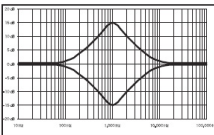

- **Center/Cutoff Frequency (Centrum-/Afsnijfrequentie):** selecteert de centrumfrequentie van de piekcurve en bandsperfilter of de afsnijfrequentie van de hellingscurves op hoog of laag.

I	N	A				E	Q	1			P	e	a	k
2	k	0	0			1	.	0			-	5	.	0

- **Bandwidth (Bandbreedte):** stelt de breedte in van de piekcurve of de curve van de bandsperfilter. Dit is niet van toepassing op de hellingscurves op hoog of laag.

I	N	A		E	Q	1		P	e	a	k
2	k	0	0	1	.	0		-	5	.	0

Piekcurve

Peaking

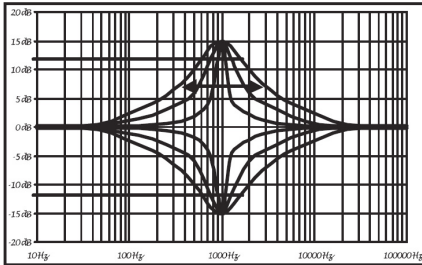

Notch bandsperfilter

Notch

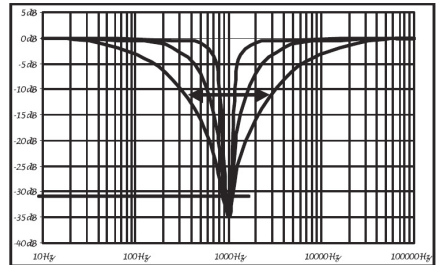

- **Gain (Versterking):** hiermee kunt u de geselecteerde frequenties versterken of verzwakken. Dit is niet van toepassing bij gebruik van de **bandsperfilter**.

I	N	A		E	Q	1		P	e	a	k
2	k	0	0	1	.	0		-	5	.	0

piekcurve

Peaking

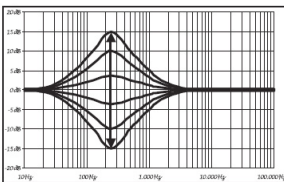

hellingscurve op laag

Low Shelving

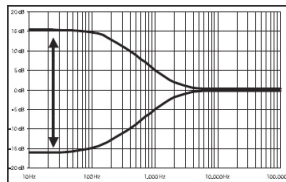

hellingscurve op hoog

High Shelving

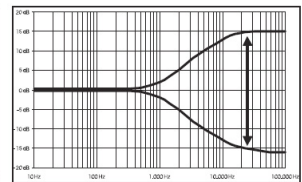

De filterwaarden kunnen worden ingesteld binnen de volgende bereiken:

5-BAND FULL PARAMETRIC EQ				
NAME	TYPE	GAIN	FREQ	WIDTH
Peak	Peaking	±15dB (step 0.5dB)	15.6Hz ~ 16kHz	0,05 ~ 3,00 oct (step 0,05 oct)
LoSh 6	Low Shelving 6dB/oct			
LoSh 12	Low Shelving 12dB/oct			
HiSh 6	High Shelving 6dB/oct			
HiSh 12	High Shelving 12dB/oct			
Notch	Notch Filter	- 45dB (fix)		0,05 ~ 3,00 oct (step 0,05 oct)

- **Xover:** laagdoorlaat- en hoogdoorlaatfilters.



Vertraging ▶ Laagdoorlaatfilter ▶ Hoogdoorlaatfilter ▶ 5-bands EQ ▶ Niveau ▶ Polariteit ▶ Limiter ▶ LED-meter ▶ Dempen ▶ Digitaal-analoogomzetter ▶ Uitgang

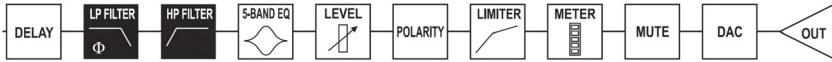

Elk Xover-filter heeft twee licht verschillende pagina's (één voor elk filter), waar de naam van de uitgang die het beïnvloedt en het type filter wordt weergegeven:

- **Low Pass Filter (Laagdoorlaatfilter):** hiermee kunt alle frequenties onder een bepaald bereik doorlaten en alle frequenties erboven afsnijden.

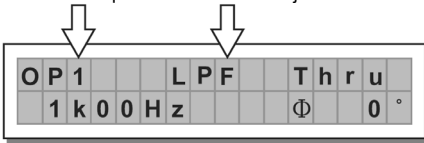

- **High Pass Filter (Hoogdoorlaatfilter):** hiermee kunt alle frequenties boven een bepaald bereik doorlaten en alle frequenties eronder afsnijden.

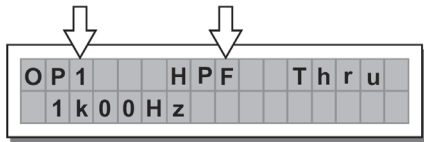

- **Crossover frequency (Crossoverfrequentie):** past de afsnijfrequentie van het filter aan.

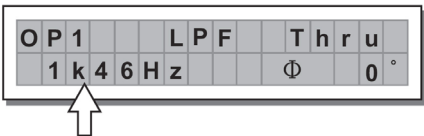

- **Phase (Fase):** maakt controle mogelijk van de signaalfase.

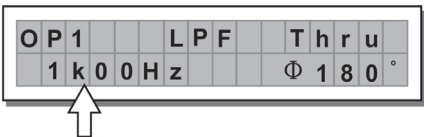

Opmerking: Dit besturingselement is alleen beschikbaar in het venster Laagdoorlaatfilter.

De Xover-filterwaarden kunnen worden ingesteld binnen de volgende bereiken:

XOVER					
	NAME	TYPE	SLOPE	FREQ	PHASE
LPF	Thru			15.6Hz ~ 16KHz	0° ~ 180° (Stp 5°)
	But	Butterworth	6, 12, 18, 24 dB/oct		
	Bes	Bessel	12, 18, 24 dB/oct		
	LR	Linkwitz-Riley	12, 24, 48 dB/oct		
HPF	Thru			15.6Hz ~ 16KHz	
	Hish 6	Butterworth	6, 12, 18, 24 dB/oct		
	Hish 12	Bessel	12, 18, 24 dB/oct		
	Notch	Linkwitz-Riley	12, 24, 48 dB/oct		

Output Pol: bepaalt de polariteit van de uitgang. Hiermee kunt u de fase van het signaal op individuele uitgangen omkeren. Het effect werkt met 5 stappen in een bereik tussen 0 en 180. Op deze manier is het mogelijk om de fase van elke individuele uitgang in te stellen met 5 stappen binnen een volledige omwenteling van 360 graden. Deze functie is handig bij het samenstellen van reeksen luidsprekerboxen, door de controle van de interpolatie tussen de verschillende boxen of tussen delen van hetzelfde systeem.

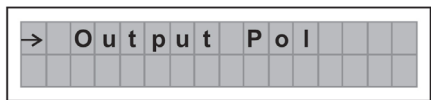

Output Limiter (Uitgangslimiter): zorgt ervoor dat het signaal van elke individuele uitgang binnen een bepaald niveau blijft.

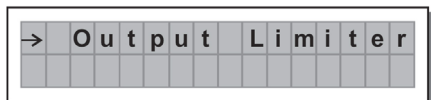

- **Reaction times (Reactietijden):** past aan tussen de 3 types reactiesnelheden van de limiter:
 - Fast (Snel):** geschikt voor een snelle werking van de limiter, normaal voor signalen die instaan voor de hoge frequenties.
 - Normal (Normaal):** geschikt voor de meeste toepassingen, voor signalen die instaan voor de middenfrequenties of volledige systemen.
 - Slow (Traag):** geschikt om sprongen te vermijden in het niveau en voor signalen die instaan voor de lage frequenties.

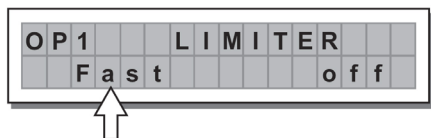

LIMITER	ATTACK	RELEASE
FAST	1 ms	10 ms
NORMAL	8 ms	80 ms
SLOW	45 ms	450 ms

- **Threshold (Drempel):** stelt het niveau in waarboven de limiter begint te werken.

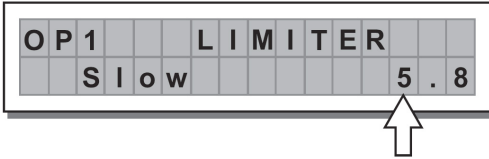

BELANGRIJK! De LIMITER inschakelen op een bepaalde uitgang verandert ook de manier waarop het niveau wordt weergegeven op de bijbehorende LED. Het niveau is niet langer het "absolute" uitgangsniveau, maar het niveau van het signaal op -24dB, -12dB, -6dB in vergelijking met de **limiterdrempel** (aangegeven door de oranje **LIMIT LED**), onafhankelijk van de waarde van de drempel.

UTILITY MENU (MENU SYSTEEMOPTIES): geeft toegang tot de systeemopties zoals de bediening van de Multimedia Memory Card of de bescherming tegen toevallige of ongeoorloofde wijzigingen.

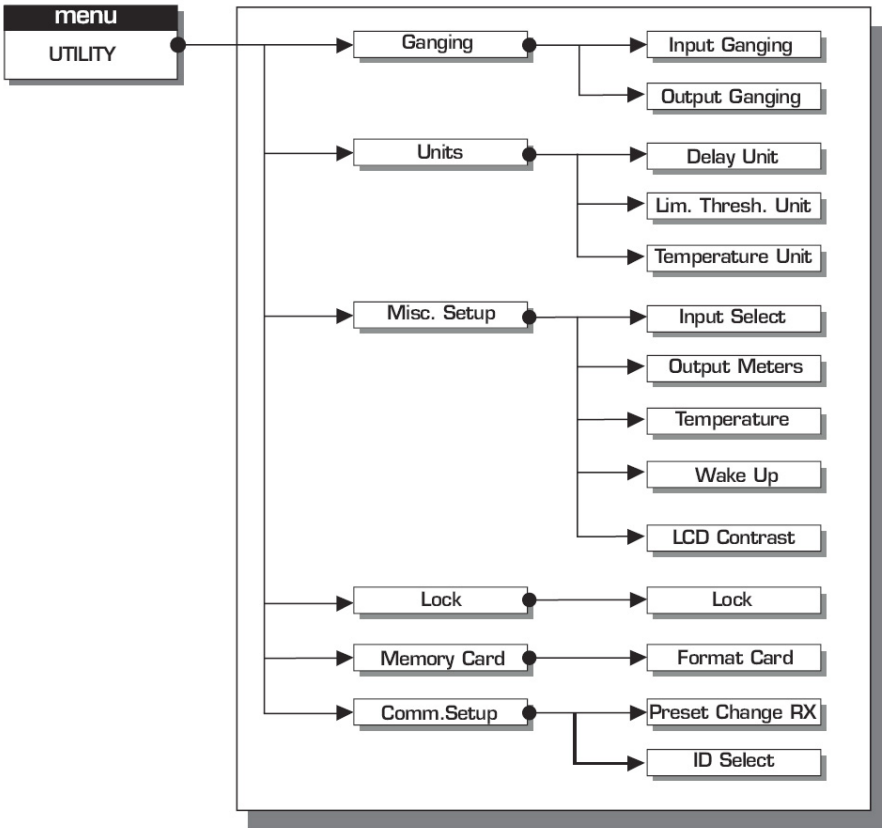

SUBMENU GANGING (GROEPEREN): laat toe om ingangen en/of uitgangen te groeperen. Het kan bijvoorbeeld worden gebruikt om de linker- en rechtersecties van een stereo-sigitaal aan te passen aan dezelfde vertraging- of equalizerwaarde aan beide ingangen met slechts een handeling; of voor de instelling van identieke Xover-filterparameters voor de verschillende uitgangen, gestuurd naar een stereo-installatie. De groeperingsfunctie kan voor zowel ingangsgroepen als uitgangsgroepen afzonderlijk worden ingeschakeld.

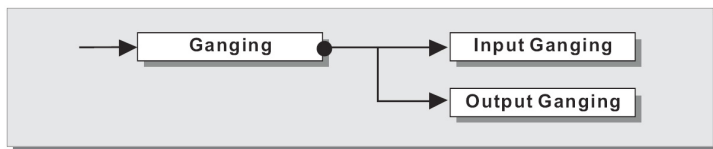

Input Ganging (Ingangsgroepering): activeert of deactiveert de groeperingsfunctie op de ingangen. De instellingen zijn de volgende:

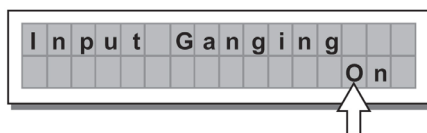
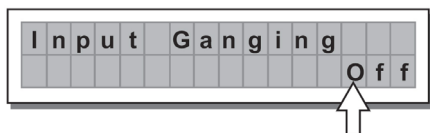

Output Ganging (Uitgangsgroepering): activeert of deactiveert de groeperingsfunctie op de uitgangen. De instellingen zijn de volgende:

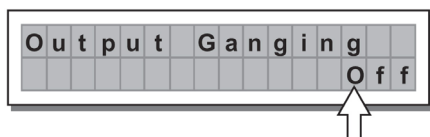

BELANGRIJK:

Zodra ingangen en/of uitgangen zijn gegroepeerd, tonen de verschillende menupagina's alleen de waarden die daadwerkelijk kunnen worden gebruikt.

SUBMENU UNITS (EENHEDEN)

Kies de meeteenheden die moeten worden gebruikt met bepaalde functies.

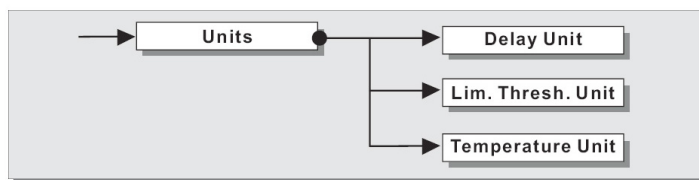

• **Delay Unit (Vertragingseenheid):** Hiermee stelt u de meeteenheid in waarmee vertragingen worden uitgedrukt.

De opties zijn: **m** = meter - **mm** = millimeter - **ms** = milliseconden - **µs** = microseconden

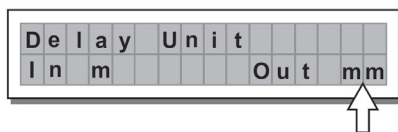
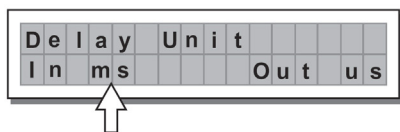

- **Lim. Thresh. Unit:** hiermee stelt u de meeteenheden in voor de drempel van de limiter (menu **EDIT - Output Limiter**).

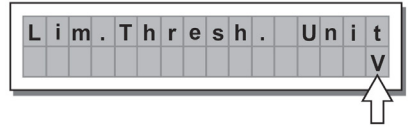
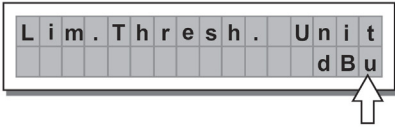

De opties omvatten: **dBu** = decibel (0 dBu = 0,775 V rms) - **V** = volt

- **Temperature Unit (Temperatuureenheid):** hiermee stelt u de meeteenheden in voor de temperatuurfunctie (menu **UTILITY - submenu Misc. Setup**). Beschikbare opties: **C** = graden Celsius - **F** = graden Fahrenheit

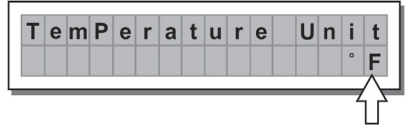
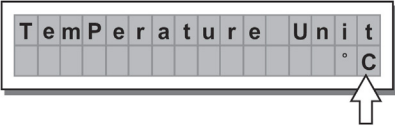

SUBMENU MISC. SETUP: stelt een aantal systeemopties in.

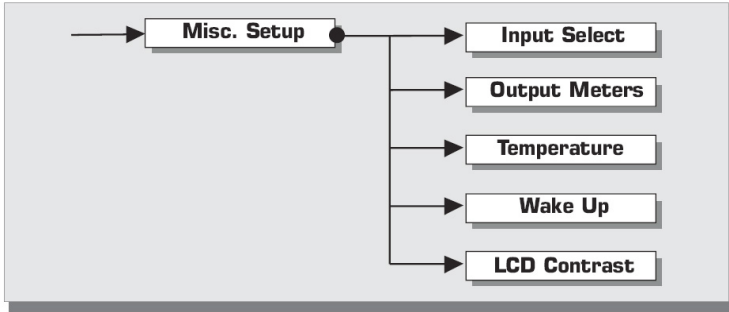

- **Input Select (Ingang selecteren):** kies de ingangen die STAGEDRIVE+ moet gebruiken, digitaal of analog.



- **Output Meters (Uitgangsmeters):** kies of u het geluidssignaal weergeeft voor of na MUTE (DEMPEN). Beschikbare opties:

PreMute: het signaal is altijd getoond, ongeacht de dempingsstatus

PostMute: het signaal wordt alleen weergegeven als de uitgang niet is gedempt

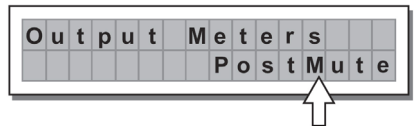
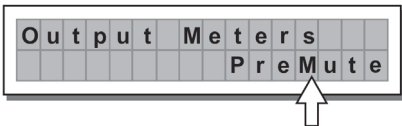

- **Temperatuur:** stelt de waarde van de omgevingstemperatuur op de plaats van installatie om te compenseren voor verschillen te wijten aan de wisselende snelheid van geluidsoverdracht als gevolg van de luchttemperatuur. De te bewerken waarden bevinden zich in het volgende bereik: **+60 C ~ -30 C** met stappen van 1 C, **140,0 F ~ -22,0 F** met stappen van 1,8 F

Opmerking: Voor de eenheden kan worden gekozen tussen C (graden Celsius) en F (graden Fahrenheit) in de functie Temperature Unit (menu UTILITY - submenu Units).



- **Wake Up (Wakker worden):** hiermee stelt u in welke MUTE-functies hersteld worden wanneer de STAGEDRIVE+ wordt ingeschakeld.

Beschikbare opties:

Normal: bij het inschakelen herstelt het systeem de laatste MUTE-configuratie van voordat het systeem werd uitgeschakeld

Mute: wanneer het apparaat is ingeschakeld, stelt het systeem automatisch alle uitgangen in op MUTE (DEMPEN)

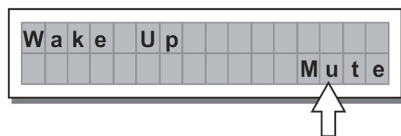
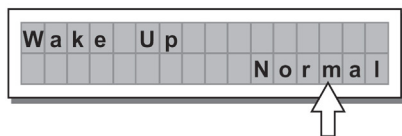

LCD-contrast: hiermee past u het contrast aan van het display.



SUBMENU LOCK (VERGRENDELEN): wordt gebruikt om de beveiliging van het systeem tegen toevallige of ongeoorloofde wijzigingen in of uit te schakelen.

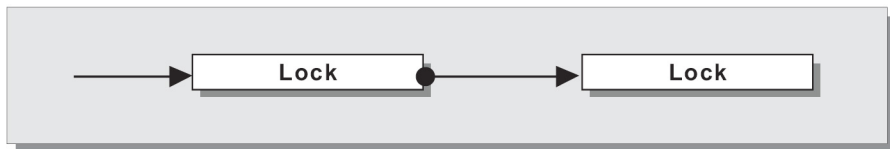

Beveiliging inschakelen

1. Kies een beveiligingsmodus (Gedeeltelijk of Totaal).
2. Gebruik de toetsen ◀ en ▶ om naar het gebied te navigeren waar het **wachtwoord** kan worden ingevoerd.
3. Het wachtwoord kan bestaan uit vier alfanumerieke tekens, verkrijgbaar met behulp van de toetsen ◀ en ▶ en bewerkbaar met de **DRAAIKNOOP**.
4. Na invoer van het wachtwoord drukt u op **ENTER**.

Opmerking: Een bevestiging wordt alleen geaccepteerd als de cursor is geplaatst op één van de vier wachtwoordtekens. Dat voorkomt het toevallig activeren van beveiliging zonder het wachtwoord te hebben gezien.

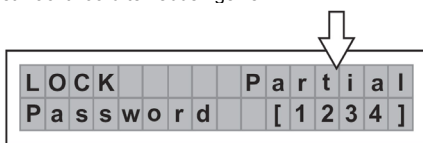
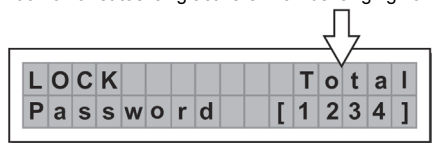

Beveiliging uitschakelen

1. Ga naar het submenu **LOCK (VERGRENDELEN)**.
2. Het display verschijnt een boodschap die vraagt om het wachtwoord in te voeren om de bescherming te ontgrendelen.
3. Voer het **wachtwoord** in met behulp van de toetsen ◀ en ▶ en de **DRAAIKNOP** en druk daarna op

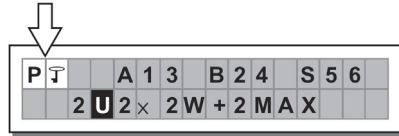
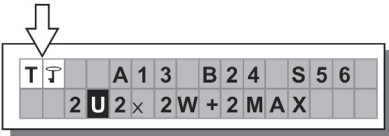

ENTER.

Opmerking: bij een onjuist ingevoerd wachtwoord verschijnt er opnieuw een boodschap op het scherm, waarbij alle tekens zijn versleuteld.

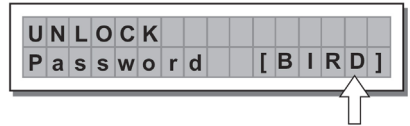
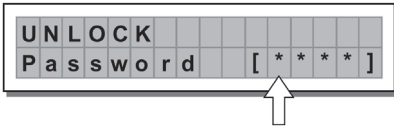

BELANGRIJK! Als u het wachtwoord niet meer kent, zet dan het apparaat aan terwijl u de toetsen "PREV" en "◀" indrukt. Nu is de bescherming ontgrendeld.

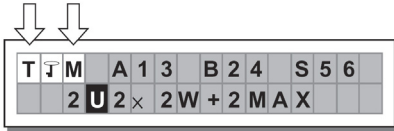

Opmerking: Naast het symbool van volledige of gedeeltelijke bescherming kan ook de letter 'M' verschijnen. Dat betekent dat het het systeem beveiligd is, maar dat de PRESET (VOORINSTELLING) in kwestie een of meer wijzigingen heeft ondergaan die nog niet zijn opgeslagen. U kunt echter het systeem zonder problemen aan en uit zetten, omdat de huidige instellingen worden bewaard in het buffergeheugen. Het is niettemin raadzaam, als dit uw voornaamste setup is, om de gegevens op te slaan in een PRESET.

SUBMENU MEMORY CARD (GEHEUGENKAART): hiermee kunt u de Multimedia Memory Card formatteren (wissen). Een kaart kan niet naar behoren worden gebruikt door het systeem als de kaart niet eerst is geformatteerd door het apparaat.

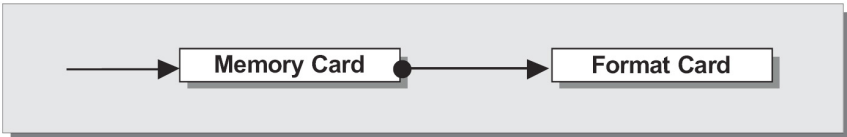

De kaart formatteren

1. Plaats een Multimedia Memory Card in de sleuf.
2. In het submenu Memory Card drukt u op **ENTER**
3. Druk nogmaals op **ENTER** om het formatteren te starten.
4. Het systeem formateert de kaart totdat deze meedeelt dat de handeling is voltooid.



Let op: in het geval van een fout of een kaartfout, als er geen kaart in de sleuf zit of als de kaart wordt verwijderd tijdens het formatteren, geeft het display de volgende melding:

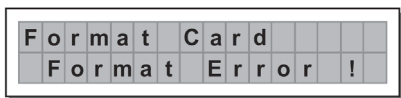

Tijdens het formatteren slaat het systeem automatisch de "Standaard"-VOORINSTELLING op in alle 128 kaartgeheugengebieden.

Let op: omdat het systeem altijd moet worden geconfigureerd, zijn er geen lege geheugengebieden. Alle gebruikers- en kaartgebieden die nog niet worden gebruikt voor opgeslagen gebruikersgegevens worden automatisch ingenomen door de "Standaard"-VOORINSTELLING, die een standaardconfiguratie bevat met alle waarden van de verschillende parameters op nul.

SUBMENU COMM. SETUP

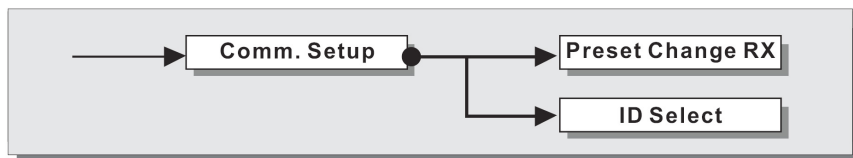

Dit submenu biedt toegang tot het instellen van de communicatie via de RS485-poorten met andere apparaten.

Opmerking: De functies Dump Out Preset (Voorinstelling versturen) en Incoming Dump (Binnenkomende gegevensdump) zijn een uitzondering, omdat ze direct worden bestuurd vanuit het menu PRESET (VOORINSTELLING).

PRESET Change RX (Ontvangen verandering van VOORINSTELLING)

Hiermee kunt u de verandering van VOORINSTELLING, verstuurd via de USB-poort van een computer of een andere STAGEDRIVE+ accepteren of negeren bij het laden van een VOORINSTELLING. De instellingen kunnen de volgende zijn:

- Inkomende opdrachten voor verandering van VOORINSTELLINGEN negeren.
- Opdrachten voor veranderingen van VOORINSTELLINGEN accepteren en uitvoeren.

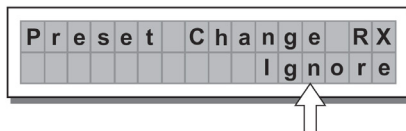
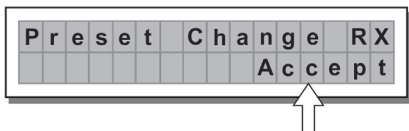

SETUP VAN HET SOFTWARESTUURPROGRAMMA

1. Plaats de meegeleverde software-cd in de cd-romspeler van uw computer.
2. Navigeer naar de map MaxiDrive3.4 DPA software/USB Driver om het programma PL-2303 Driver Installer.exe voor uw versie van Windows te vinden en te installeren.
3. Nadat het stuurprogramma is geïnstalleerd, schakelt u de STAGEDRIVE+ in en sluit u de USB-kabel aan op de USB-poort van de STAGEDRIVE+ en de USB-poort van uw pc.
4. Klik met de rechtermuisknop op **MIJN COMPUTER** en klik vervolgens op **EIGENSCHAPPEN**
5. Klik op het tabblad **HARDWARE** en selecteer **APPARAATBEHEER**
6. Dubbelklik op **POORTEN (COM & LPT)** en zoek naar de poort **PROLIFIC USB-to-SERIAL Com**
7. Dubbelklik op de poort **PROLIFIC USB-to-SERIAL Com** en klik vervolgens op **POORTINSTELLINGEN** en daarna op **GEAVANCEERD**
8. Wijzig het **COM-POORTNUMMER** in **COM1** (of een andere niet-gebruikte com-poort) en klik op OK.

SETUP VAN DE SOFTWARE

De software-editor kan worden geïnstalleerd zoals hieronder weergegeven:

1. Zodra het softwarestuurprogramma is geïnstalleerd (met de STAGEDRIVE+ ingeschakeld en aangesloten op de computer via USB), start u het programma met de software-editor op.
2. Selecteer **New (Nieuw)**.

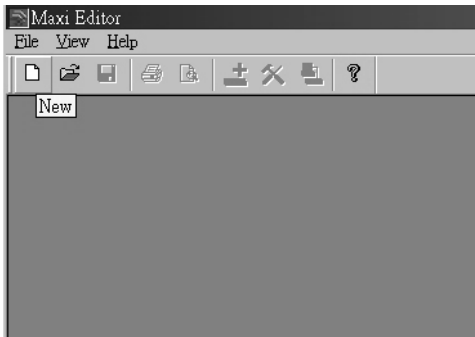

3. Kies uw interface uit de lijst.
4. Selecteer **Network Scan (Netwerk scannen)**.

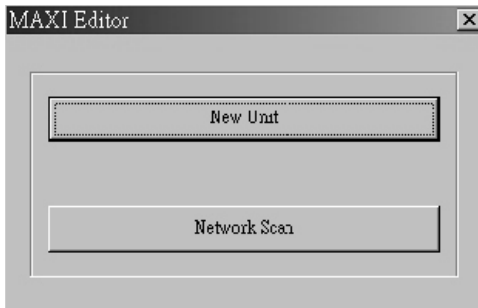

5. Als het scannen van het netwerk mislukt, controleer dan het nummer van de **Device ID (Apparaat-id)**. Selecteer **New Unit (Nieuw apparaat)** om de interface te selecteren. Zorg ervoor dat het id-nummer van de STAGEDRIVE+ 1 is of overeenkomt met het nummer van de **Device ID**.

6. Selecteer **OK** om op het volgende scherm terecht te komen:

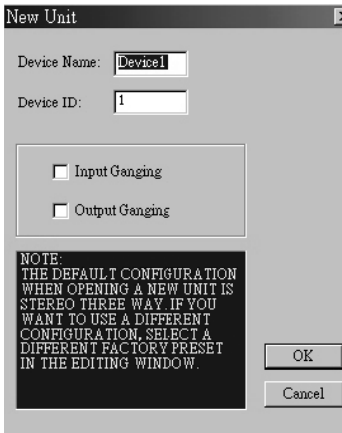

7. Selecteer het pictogram **Options (Opties)** om op het volgende scherm terecht te komen:



8. Selecteer **RS232** met voor de poort de com-instelling die u hebt gekozen tijdens de installatie van het softwarestuurprogramma en 38400 (of 19200) als Baud Rate.

OPMERKING: Zorg ervoor dat de instellingen op de computer overeenkomen met wat er in de STAGEDRIVE+ is ingesteld.

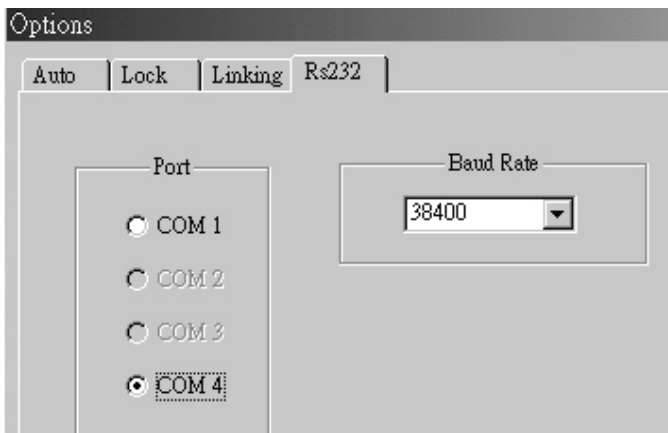

9. Selecteer na op **OK** te hebben geklikt **On/Off Line** op het hoofdscherm.

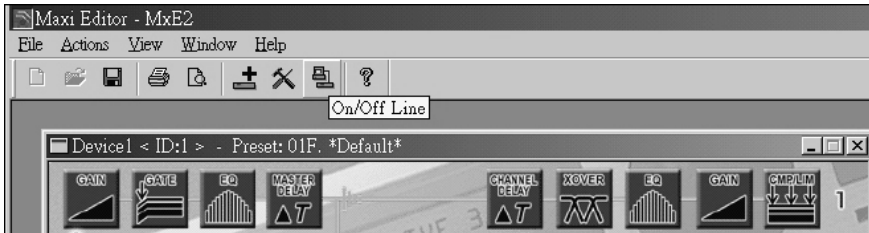

10. Hierdoor verschijnt de interface. Klikken op **OK** maakt een verbinding met de uitrusting.

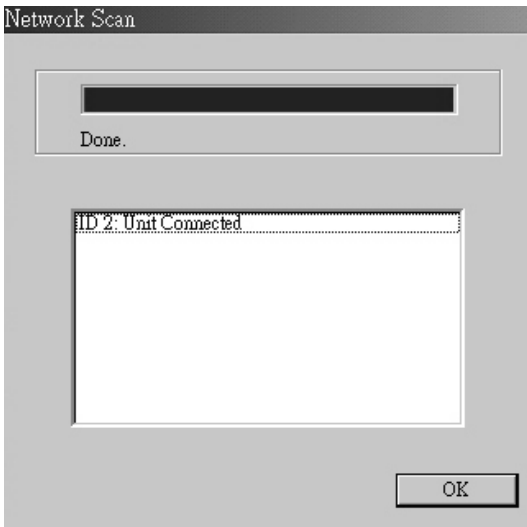

11. Wanneer de koppeling verbinding heeft gemaakt, verschijnt er ONLINE.

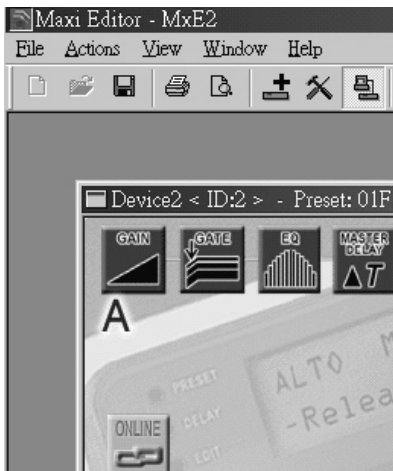

VOORBEELDEN VAN AANSLUITINGEN

De volgende voorbeelden helpen u de STAGEDRIVE+ aan te sluiten en gebruiken.
A13 B24 S56 2-WEGS STEREO+2 MONO AUX [2 2W+2MAX]

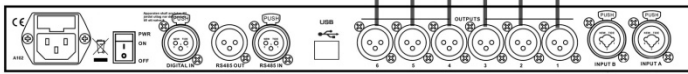
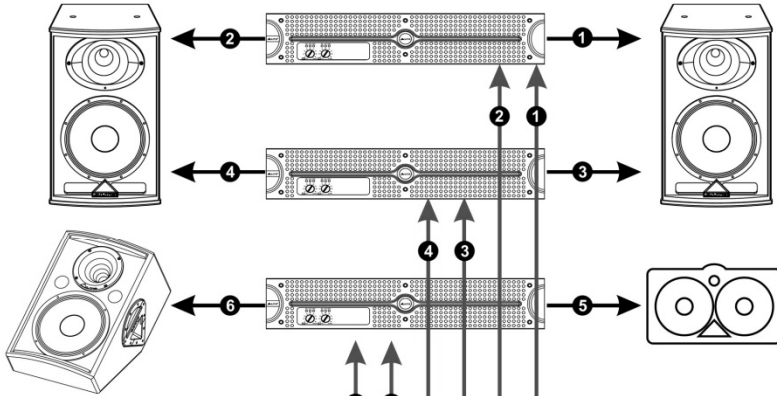
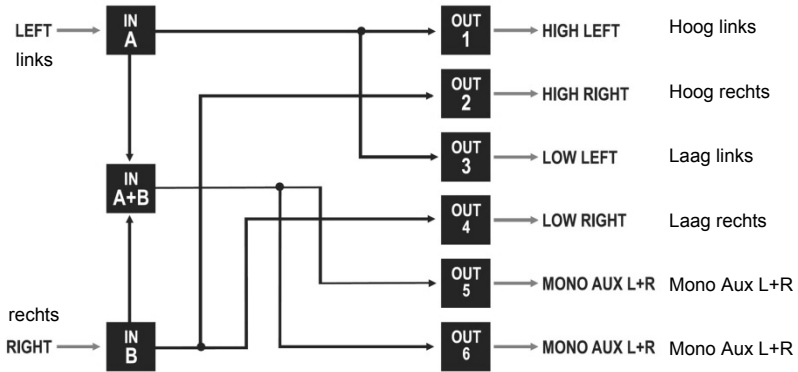

STAGEDRIVE+

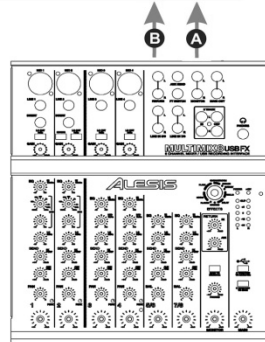
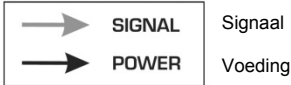

A135 B246 3-WEGS STEREO [2X3W]

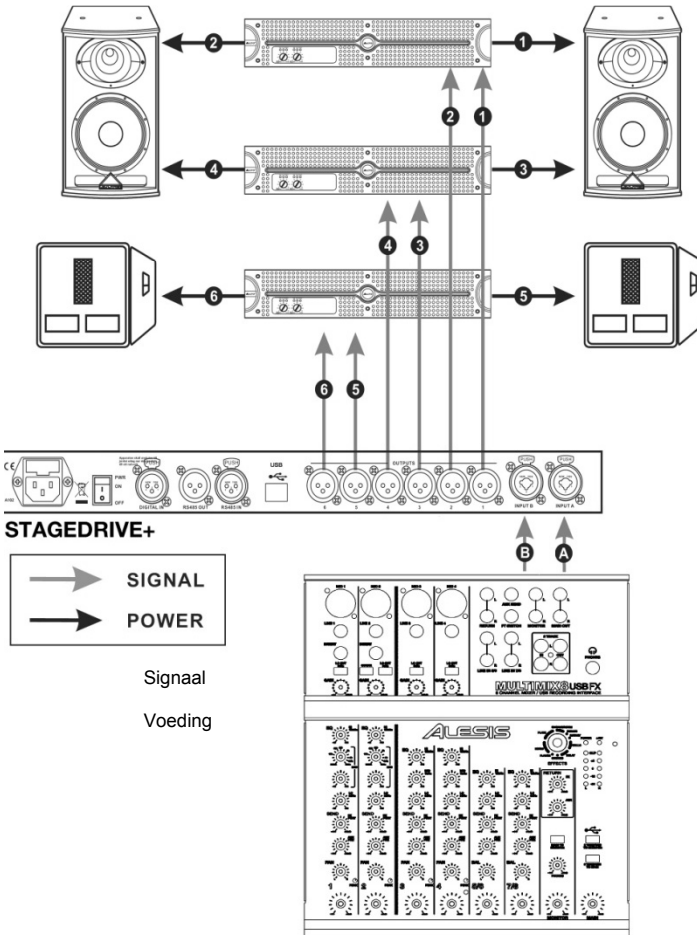
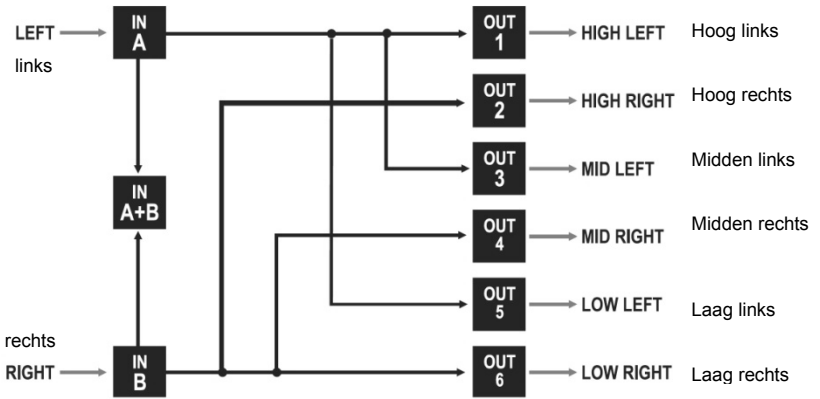

A13 B24 S56 3-WEGS STEREO met MONO SUB+MONO AUX [2 3W+MSB+MAX]

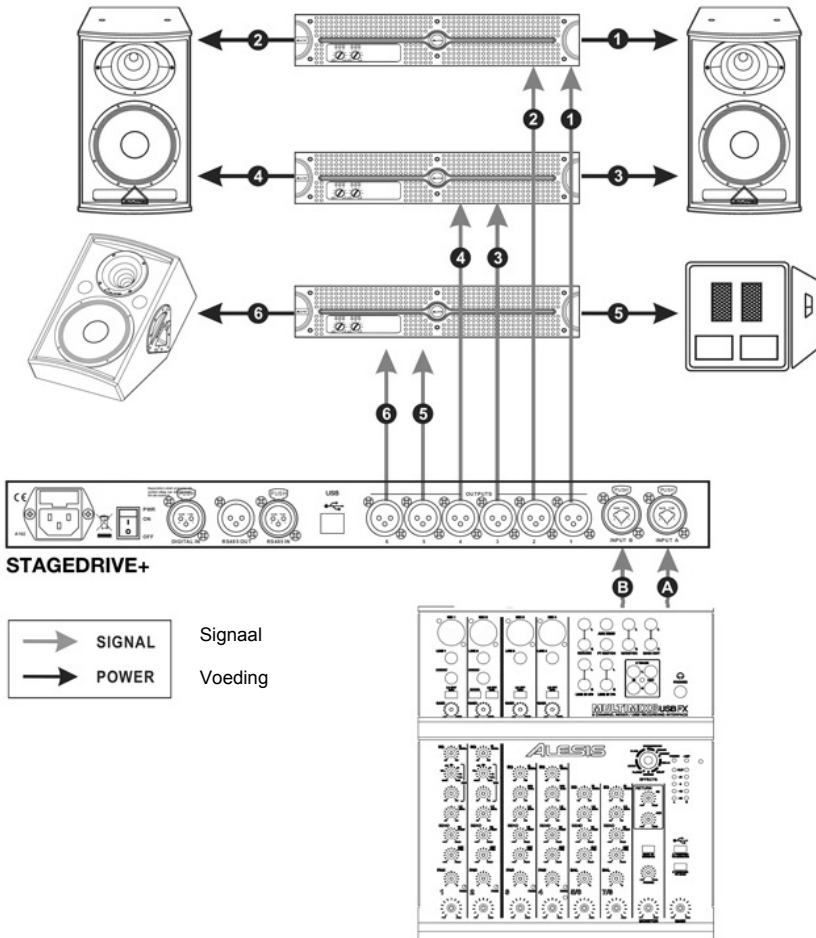

A1324 S56 4-WEGS 4 MONO + 2 MONO AUX [4W+2MAX]

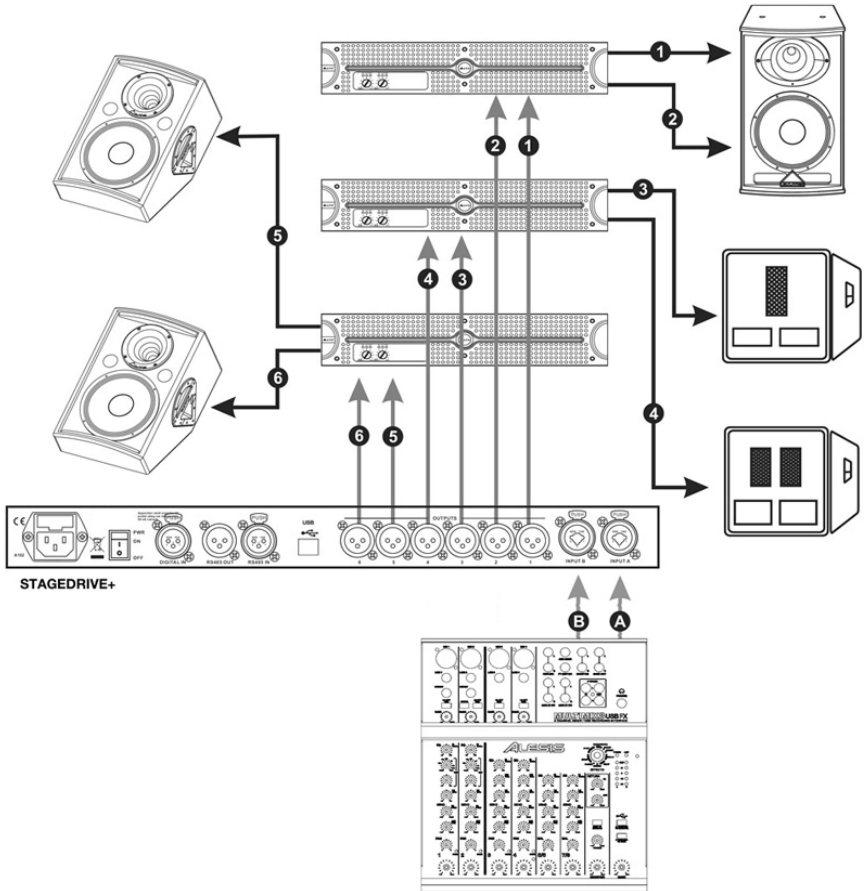
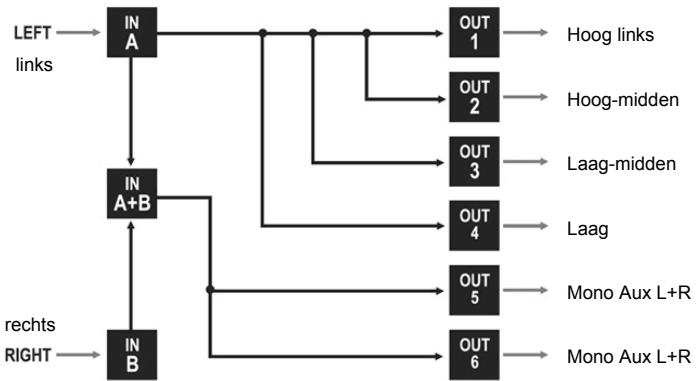

A135 B246 3-WEGS STEREO [2x2W]

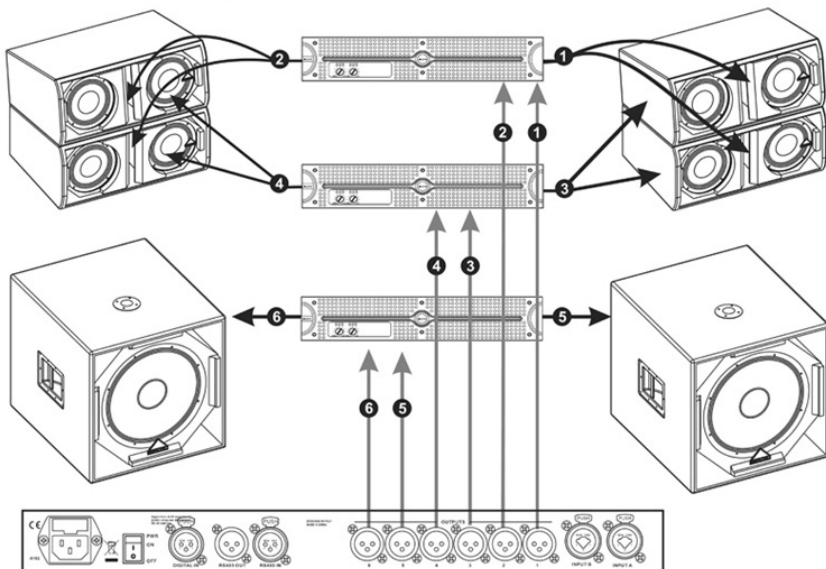
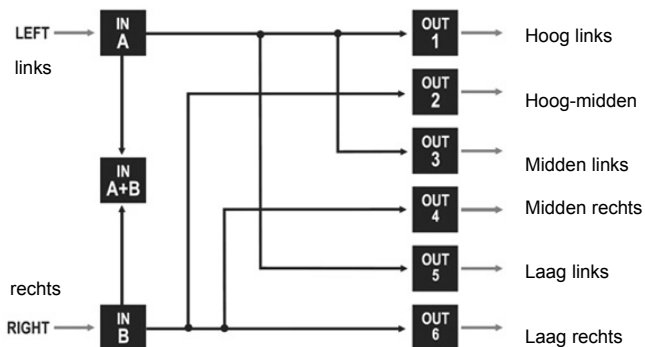

STAGEDRIVE+

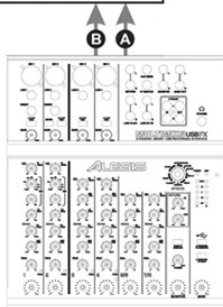

SPECIFICATIONS

GENERAL SPECIFICATIONS

- Frequency Response: 20Hz - 20kHz, 0.25dB
- Dynamic range: >117dB 20Hz to 20kHz, >120dB 20Hz to 20kHz on AES/EBU input
- Channel Separation: >100dB 20Hz to 20kHz

INPUT IMPEDANCE

- Input Impedance: 30kOhm, electronically balanced
- Maximum Input Level: +20dBu
- Input Gain: -30 / +6 dB variable in 0.5 dB steps
- Digital input: AES/EBU, XLR-F
- Digital input sample rate: 32 kHz ~ 48 kHz

OUTPUT SECTION

- Output Impedance: 600 Ohms, electronically balanced
- Nominal Output Level: 0 dBu
- Maximum Output Level: +20 dBu
- Output Gain: -30 / +6 dB variable in 0.5 dB steps

DSP SECTION

- A/D D/A converters: 20 bit
- Internal dynamics: 40 bit
- Sampling frequency: 48 kHz

FEATURES

- Max Delay time: 2621 ms (inputs), 291 ms (outputs)
- EQ filters: Up to 40 maximum (depending on the crossover slope)
- 10 factory presets / 64 user presets / 128 card presets

Factory Preset Configuration

#	Name	Configuration	Description
01	DEFAULT	A135 B246	Default preset routing= 3-Way Stereo
02	2x2W+MAX	A13 B24 S56	2-Way Stereo+ 2 Mono full range out
03	2x3W	A135 B246	3-Way Stereo
04	2x3W+MSB+MAX	A13 B24 S56	3-Way Stereo w/Mono Sub+ 1 Mono full range out
05	4W+2MAX	A1324 S56	4-Way Mono+2 Mono full range out
06	4W+BSB+2MAX	A123 B4 S56	4-Way Mono w/ B-Sub+ 2 MONO full range out
07	5W+MAX	A12345 S6	5-Way Mono+ 1 Mono full range out
08	5W+BSB+MAX	A1234 B5 S6	5-Way Mono w/ B-Sub+ 1 Mono full range out
09	6W	A123456	6-Way Mono
10	6W+BSB	A12345 B6	6-Way Mono w/ B-Sub

POWER

- Switching power supply

DIMENSIONS (W x L x H):

- 19in x 11.8in x 1.7in (483mm x 44mm x 300 mm)

WEIGHT:

- 18.8 lb (4.0 Kg)

www.altoprofessional.com