



▶▶ NEUMANN.BERLIN

- ▶ KH 310 A
- ▶ KH 310 D

---

ACTIVE STUDIO MONITOR

OPERATING MANUAL







## Contents

|  |    |
|--|----|
| <b>Important safety instructions</b> .....                               | 2  |
| <b>The KH 310 studio monitor</b> .....                                   | 4  |
| <b>Package contents</b> .....  | 4  |
| <b>Product overview</b> .....  | 5  |
| <b>Installing and connecting the KH 310</b> .....                        | 7  |
| Preparing the loudspeakers .....   | 7  |
| Preparing the room .....   | 8  |
| Positioning the loudspeakers .....                                       | 8  |
| Connecting audio signals .....   | 11 |
| Connecting/disconnecting the KH 310 to/from the mains power supply ..... | 14 |
| <b>Configuring and using the KH 310</b> .....                            | 14 |
| Switching the KH 310 on/off .....  | 14 |
| Adjusting the frequency response .....                                   | 14 |
| Adjusting the acoustical level .....                                     | 15 |
| Compensating for video delay (lip sync) .....                            | 16 |
| Compensating for listening distance differences (time-of-flight) .....   | 16 |
| Activating ground lift .....   | 17 |
| Adjusting the brightness of the Neumann logo .....                       | 18 |
| <b>Cleaning and maintaining the KH 310</b> .....                         | 18 |
| <b>Troubleshooting</b> .....   | 19 |
| <b>Specifications</b> .....  | 19 |
| <b>Accessories</b> .....   | 21 |
| <br>   |    |
| <b>Appendix</b>  |    |
| System Block Diagram .....   | I  |
| Pin assignment of the XLR socket .....                                   | I  |
| Acoustical Measurements .....  | I  |
| Installation angles .....  | V  |
| Delay lookup table .....   | VI |



## Important safety instructions

1. Read these instructions.
2. Keep these instructions. Always include these instructions when passing the product on to third parties.
3. Heed all warnings.
4. Follow all instructions.
5. Do not use this apparatus near water.
6. Only clean the product when it is not connected to the mains power supply. Clean only with a dry cloth.
7. Always ensure a free air flow around the cooling fins on the rear of the product. Do not block any ventilation openings. Install in accordance with the manufacturer's instructions.
8. Do not install near any heat sources such as radiators, heat registers, stoves, or other apparatus (including amplifiers) that produce heat.
9. Do not defeat the safety purpose of the polarized or grounding-type plug. A polarized plug has two blades with one wider than the other. A grounding type plug has two blades and a third grounding prong. The wide blade or the third prong are provided for your safety. If the provided plug does not fit into your outlet, consult an electrician for replacement of the obsolete outlet.
10. Protect the power cord from being walked on or pinched, particularly at plugs, convenience receptacles, and the point where it exits from the apparatus.
11. Only use attachments/accessories specified by the manufacturer.
12. Use only with the cart, stand, tripod, bracket, or table specified by the manufacturer, or sold with the apparatus. When a cart is used, use caution when moving the cart/apparatus combination to avoid injury from tip-over. 
13. Unplug this apparatus during lightning storms or when unused for long periods of time.
14. Refer all servicing to qualified service personnel. Servicing is required when the apparatus has been damaged in any way, such as power supply cord or plug is damaged, liquid has been spilled or objects have fallen into the apparatus, when the apparatus has been exposed to rain or moisture, does not operate normally, or has been dropped.
15. To completely disconnect this apparatus from the AC mains, disconnect the power supply cord plug from the AC receptacle.
16. **WARNING:** To reduce the risk of fire or electric shock, do not expose this apparatus to rain or moisture.
17. Do not expose this equipment to dripping or splashing and ensure that no objects filled with liquids, such as vases, are placed on the equipment.
18. The mains plug of the power supply cord shall remain readily accessible.

- Installation**
- Ensure that the room in which you use this product is wired in accordance with the local electrical code and checked by a qualified inspector.
  - Only use the product indoors.
  - Do not install the product in hot, humid, or excessively dusty locations, in direct sunlight or in locations where it is exposed to externally generated vibrations.
  - Do not place burning objects (e.g. candles) on top of or near the product.
  - If condensation has formed on the product, e.g. because it was moved from a cold environment to a warm one, allow the product to acclimatize to room temperature before using it.
  - Do not overload wall outlets and extension cables as this may result in fire and electric shock.



**Danger due to high sound pressure levels**

 **WARNING**  
 Danger of hearing damage due to sudden high sound pressure levels!

Audio signals that are present at switch-on of the product or that can be present during operation, can create sudden, very high sound pressure levels which can damage your hearing.

- ▶ Always lower the output level of the audio source **before** connecting it to the loudspeaker, starting it (pressing “play”) or switching to a different source (analog/digital) via the SIGNAL SELECT rotary switch ⑰.

This loudspeaker can be used for commercial purposes. Commercial use is subject to the rules and regulations of the trade association responsible. Neumann, as the manufacturer, is therefore obliged to expressly point out possible health risks arising from use. This loudspeaker is capable of producing sound pressure levels exceeding 85 dB(A) SPL. This is the sound pressure corresponding to the maximum permissible level which is by law (in some countries) allowed to affect your hearing for the duration of a working day (8 hours). It is used as a basis according to the specifications of industrial medicine.

Higher sound pressure levels and/or longer durations can damage your hearing. At higher sound pressure levels, the duration must be shortened in order to prevent hearing damage. The following are signs that you have been subjected to excessive sound pressure levels for too long a time:

- You can hear ringing or whistling sounds in your ears.
- You have the impression (even for a short time only) that you can no longer hear high frequencies (temporary threshold shift).

**Magnetic fields**

 **WARNING**  
 Interference due to magnetic fields!

This product generates a permanent magnetic field (> 1.5 mT) that can interfere with cardiac pacemakers and implanted defibrillators (ICDs).

- ▶ Always maintain a distance of at least 10 cm (4") between the loudspeaker and the cardiac pacemaker or implanted defibrillator.

**Hazard warnings on the rear of the product**

The label shown on the right is attached to the rear of the product.



The symbols on this label have the following meaning:

Presence of uninsulated dangerous voltage within the product’s enclosure that may be of sufficient magnitude to constitute a risk of fire or electric shock.

Never open the product or remove the grilles fitted to the product as there is a risk of electric shock. There are no user serviceable parts inside. Refer servicing to your Neumann service partner.



Read and follow the safety and operating instructions contained in the operating manual.



**Intended use**

Intended use of the product includes:

- having read this operating manual, especially the chapter “Important safety instructions”,
- using the product within the operating conditions and limitations described in this operating manual.

“Improper use” means using the product other than as described in this operating manual, or under operating conditions which differ from those described herein.



## The KH 310 studio monitor

Thank you for purchasing a Neumann studio monitor. The KH 310 features a Mathematically Modeled Dispersion™ Waveguide (MMD™), flexible acoustical controls, various input options and an extensive range of mounting hardware. This allows the loudspeaker to be used in diverse acoustical conditions, with any source equipment and in a wide variety of physical locations. The KH 310 represents the latest in acoustic and electronic simulation and measurement technologies to ensure the most accurate sound reproduction possible.

Depending on the size, Neumann's three-way loudspeaker systems are designed for use as near-field monitors, as front loudspeakers in mid-sized multi-channel systems, or as rear loudspeakers in larger multi-channel systems. They can be used in project, music, broadcast centers, OB vans, and post production studios for tracking, mixing, and mastering.

### Package contents

- 1 KH 310 A "left" or KH 310 A "right"  
or
- 1 KH 310 D "left" or KH 310 D "right"
- 3 Mains cables (European, UK and US versions)
- 4 Self-adhesive feet
- 1 Quick guide
- 1 Safety guide





## Product overview

**i** The KH 310 comes in two variants named “left” and “right” (see figure). It is also possible to use a “left” in the “right” position, and vice versa. Both variants can also be used as a center loudspeaker. Information about positioning your KH 310 can be found from page 8.

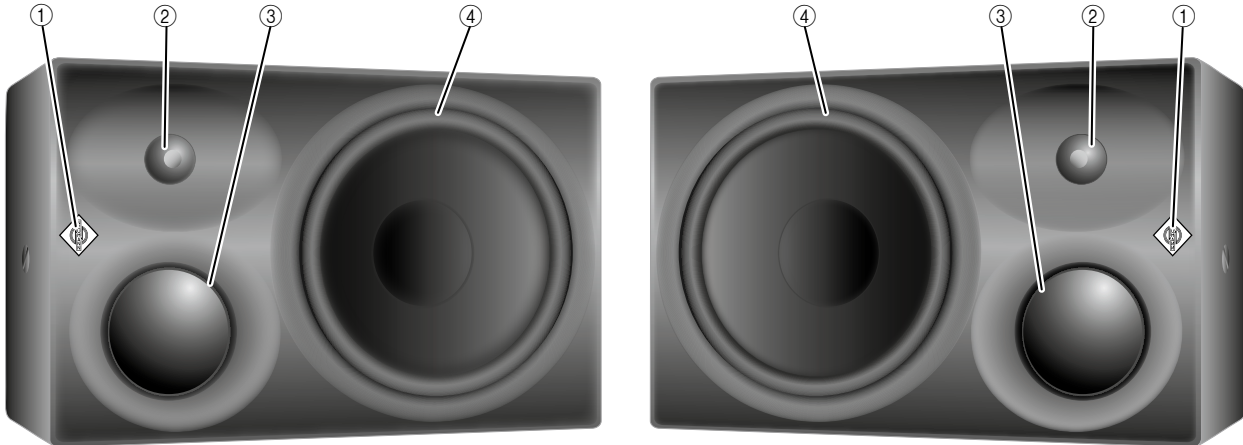

- |   |                   |
|---|-------------------|
| ① Neumann logo  | ② Treble driver   |
| • lights up white:<br>loudspeaker is switched on and ready for operation  | ③ Midrange driver |
| • flashes red:<br>loudspeaker's protection system is active<br>output level is reduced                            | ④ Bass driver     |
| or  |                   |
| A digital signal is selected via the SIGNAL SELECT rotary switch ⑰ but there is no valid digital signal connected |                   |
| • lights up red:<br>electronic's temperature is too high<br>output level is reduced by 20 dB                      |                   |

**i** You can adjust the brightness of the Neumann logo. For more information, refer to page 18.



**Back panel  
KH 310 A**

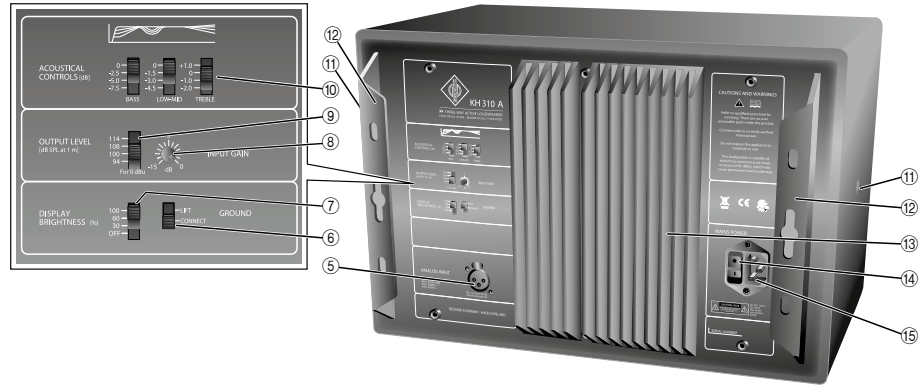

- ⑤ ANALOG INPUT socket (XLR)
- ⑥ GROUND switch  
(Connects/disconnects ground)
- ⑦ DISPLAY BRIGHTNESS switch  
(Dims the Neumann logo)
- ⑧ INPUT GAIN control
- ⑨ OUTPUT LEVEL switch
- ⑩ ACOUSTICAL CONTROLS switches
- ⑪ Threaded inserts for Neumann mounting hardware
- ⑫ Handles with mounting holes
- ⑬ Cooling fins
- ⑭ On/off switch I/O
- ⑮ IEC mains socket

**Back panel  
KH 310 D**

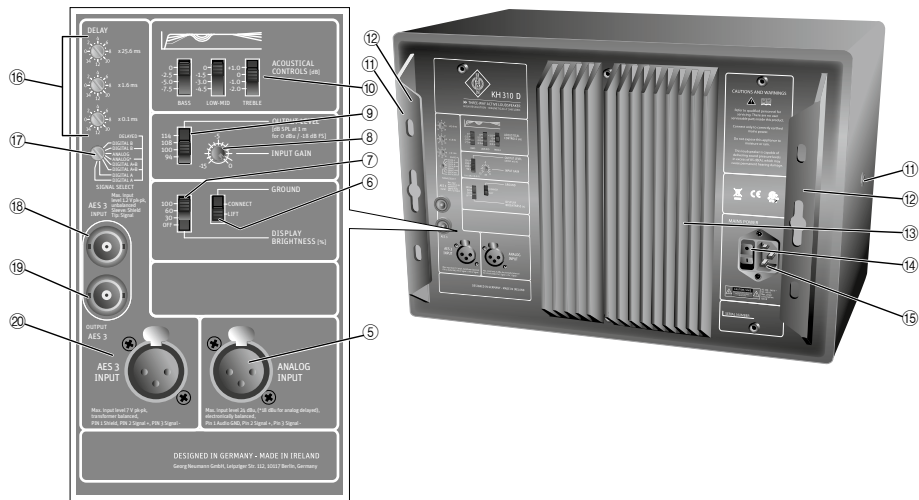

- ⑤ ANALOG INPUT socket (XLR)
- ⑥ GROUND switch  
(Connects/disconnects ground)
- ⑦ DISPLAY BRIGHTNESS switch  
(Dims the Neumann logo)
- ⑧ INPUT GAIN control
- ⑨ OUTPUT LEVEL switch
- ⑩ ACOUSTICAL CONTROLS switches
- ⑪ Threaded inserts for Neumann mounting hardware
- ⑫ Handles with mounting holes
- ⑬ Cooling fins
- ⑭ On/off switch I/O
- ⑮ IEC mains socket
- ⑯ DELAY rotary switches
- ⑰ SIGNAL SELECT rotary switch
- ⑱ AES3 INPUT socket (BNC)
- ⑲ AES3 OUTPUT socket (BNC)
- ⑳ AES3 INPUT socket (XLR)





## Installing and connecting the KH 310



### CAUTION

Danger of injury and material damage due to tipping/dropping of the product!

If improperly mounted, the product and/or the mounting hardware (e.g. rack) can tip over or drop down.

- ▶ Always have the product mounted by a qualified specialist according to local, national and international regulations and standards.
- ▶ Use the mounting systems recommended by Neumann and always provide sufficient additional protection against tipping or dropping!

### CAUTION

Damage to the product due to overheating!

If air cannot circulate properly around the cooling fins on the rear of the product, the amplifier(s) may overheat leading to premature activation of the thermal protection system which limits the maximum output level of the loudspeaker. In rare cases, damage to the product may also occur.

- ▶ Never cover the cooling fins.
- ▶ When installing the product into tight spaces such as wall recesses, maintain an air gap of at least 5 cm (2") around the rear of the product and provide sufficient air circulation. If necessary, use forced-air cooling (e.g. in OB vans).



It is not possible to remove the electronics panel and locate it remotely.



For information on installation, please refer to the supplied “Getting Started Quickly” supplement. This will help you set up the loudspeakers in a way that will give you the best acoustic performance from the system.

For further information on setting up loudspeakers, please refer to the “Questions & Answers” section on the product page at [www.neumann.com](http://www.neumann.com).

For more information on building systems using Neumann loudspeaker products, please refer to the “Product Selection Guide” at [www.neumann.com](http://www.neumann.com)

## Preparing the loudspeakers

### CAUTION

Risk of staining surfaces!

Some surfaces treated with varnish, polish or synthetics may suffer from stains when they come into contact with other synthetics. Despite a thorough testing of the synthetics used by us, we cannot rule out the possibility of staining.

- ▶ Do not place the KH 310 on delicate surfaces.



### CAUTION

Danger of damaging the midrange and bass drivers!

If the KH 310 is placed face down on a soft surface or if the front panel of the KH 310 is pressed against your body when you carry it, the drivers can be damaged.

- ▶ Never place the KH 310 on a soft surface with the front panel facing downwards.
- ▶ Always carry the KH 310 so that the front panel is facing upwards.



You can use the handles ⑫ on the rear panel to lift the loudspeaker.



To place the loudspeaker on a flat surface:

- Attach the supplied self-adhesive feet to the bottom of the cabinet.  
This reduces the risk of scratching the surface and acoustically isolates the loudspeaker from the surface.

## Preparing the room

- Arrange all acoustically relevant surfaces and objects symmetrically on either side of the listening axis of the room (left/right).
- Minimize the sound that is reflected back to the listening position by using angled surfaces and/or acoustical treatment.

 This product has been optimized for use in recording studios. In order not to affect the quality of reproduction, make sure that the product is used in an EMC environment.

## Positioning the loudspeakers

- Carry out the following steps very accurately, since the more accurate the physical arrangement of the loudspeakers in the room, the more accurate the reproduction will be at the listening position.

**Distances** ► Observe the recommended distances between the loudspeakers and your listening position (imperial dimensions are approximate):

- Minimum: 0.75 m (2' 6")
- Recommended: 1.0–2.5 m (3'–8')
- Maximum: 6.0 m (18')

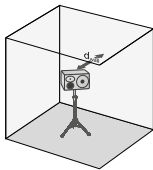

- Avoid positioning the loudspeaker at a distance “ $d_{\text{wall}}$ ” of 0.8 to 2 m (2' 6" to 6') from the wall behind the loudspeaker.

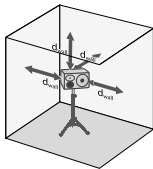

When positioning bass managed loudspeakers:

- Avoid a distance “ $d_{\text{wall}}$ ” of 0.8 to 1 m (2' 6" to 3') from a solid wall behind the loudspeaker. Similarly, avoid these distances from solid side walls or a solid ceiling. Respecting these positioning limitations reduces the chances of dips and peaks in the low frequency response (comb filtering) caused by strong reflections.

### Positioning the KH 310

The KH 310 comes in two variants named “left” and “right”.

- Position the two variants at the same height and so that the bass drivers are on the inside.

If you are building a multichannel system:

- Use either a “left” or “right” variant for the center loudspeaker. Line up the acoustical axis along the center line of the loudspeaker array (see below).

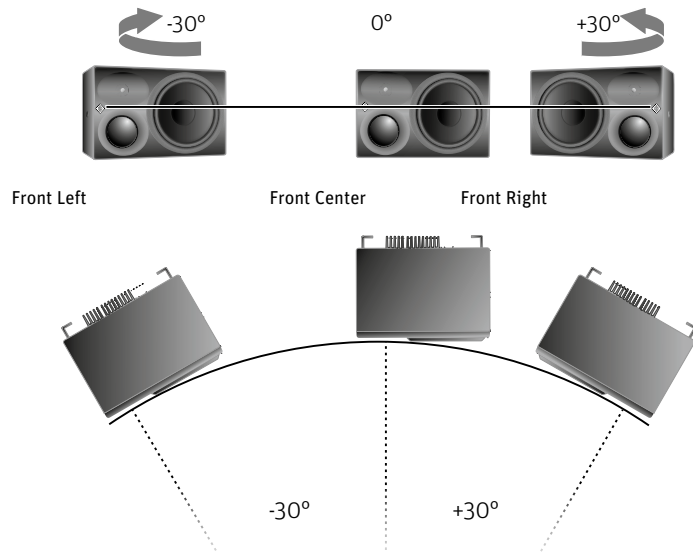

**Arranging the loudspeakers**

- ▶ Copy the diagram "Installation angles" that can be found at the end of this operating manual.
- ▶ Place the diagram at the listening position or center of the listening area.
- ▶ Using a tape measure, place the loudspeakers at the same distance from the center of the diagram "Installation angles". To ensure good imaging, do this at an accuracy of at least 1 cm (1/2").
- ▶ Make sure that the distances are equal:

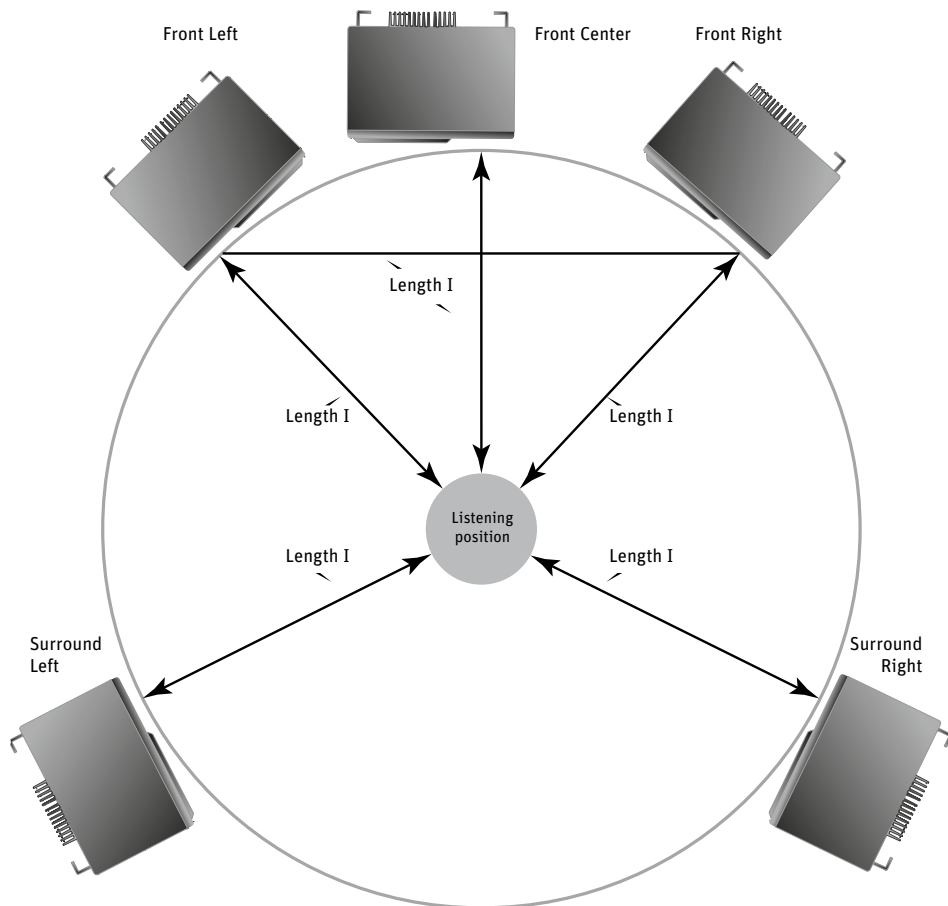



If the loudspeakers cannot be placed at the same distance from the listening position:

- ▶ Compensate for distance differences > 1 cm (1/2") by delaying closer loudspeakers by 30 µs/cm (76 µs/inch).

If you are using the KH 310 D:

**KH 310 D**

- ▶ Use the DELAY rotary switches ⑩ to compensate for distance differences (see page 16).

**i** The DELAY rotary switches ⑩ allow for corrections with a resolution of 3.44 cm (1 3/8"), any small remaining time-of-flight adjustment should be made by moving the loudspeaker cabinet.

- ▶ Check the location of the loudspeaker cabinet. This depends on the application:

- 2.0 systems (stereo): ±30°, plus optional subwoofer(s)
- 5.1 systems:
  - ITU-R BS.775-1: 0°, ±30°, ±110° (±10°), plus optional subwoofer(s) (center, front left/right, surround left/right)
  - ANSI/SMPTE 202M: 0°, ±22.5°, arrays to the surround left and to the surround right, plus optional subwoofer(s)
- 7.1 systems: 0°, ±30°, ±90°, ±150°, plus optional subwoofer(s) (center, front left/right, side left/right, back left/right)

The acoustical axis of the KH 310 starts from the midpoint of the midrange and tweeter drivers.

- ▶ Always point the acoustical axis, in the horizontal and vertical planes, towards the listening position.

**i** The acoustical axis is a line perpendicular to the loudspeaker's front panel along which the microphone was placed when tuning the loudspeaker's crossover during design. Pointing the acoustical axis, in the horizontal and vertical planes, towards the listening position or center of the monitoring area will give the best measured and perceived sound quality.

- ▶ Position the loudspeaker so that there is a direct line of sight from the listening position to the bass, midrange and tweeter drivers.

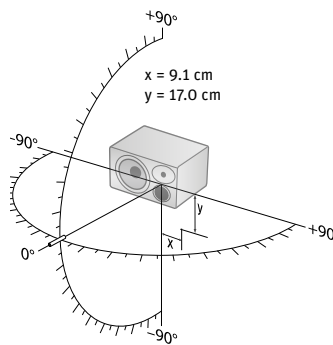



## Connecting audio signals

- ▶ Always use good quality cables with the correct impedance and appropriate termination to avoid signal drop outs and to achieve the maximum cable lengths shown below:

| Signal (connector) | Impedance | Cable length       | Connection method  |
|--------------------|-----------|--------------------|--|
| Analog (RCA)       | low       | up to 10 m (30')   | via an adapter (RCA-XLR) to the ANALOG INPUT socket (XLR) ⑤ (see below)  |
| Analog (XLR)       | low       | up to 100 m (300') | directly to the ANALOG INPUT socket (XLR) ⑤ (see below)  |
| AES3 (BNC)         | 75 Ω      | up to 100 m (300') | directly to the AES3 INPUT socket (BNC) ⑱ (see page 12)  |
| AES3 (XLR)         | 110 Ω     | up to 100 m (300') | directly to the AES3 INPUT socket (XLR) ⑳ (see page 12)  |
| S/P-DIF (RCA)      | 75 Ω      | up to 10 m (30')   | via an adapter (RCA-BNC) to the AES3 INPUT socket (BNC) ⑱ (see page 12) or via an adapter (RCA-XLR) to the AES3 INPUT socket (XLR) ⑳ (see page 12) |

### Connecting analog signals to the KH 310 A and the KH 310 D

- ▶ Only connect analog signals to the KH 310 A.
- ▶ Connect the left and right output of your analog audio source to the XLR input sockets of the respective loudspeaker.

Connecting XLR cables

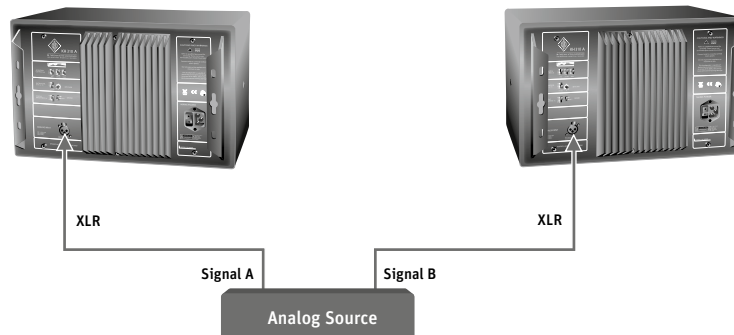

- ▶ Use an RCA-XLR adapter (not supplied) to connect unbalanced cables (e.g. RCA cables).
- ▶ Use the following wiring if you want to make your own RCA-XLR adapter:

Connecting unbalanced cables

| Wiring  | Pin | Signal       |
|---|-----|--------------|
| <p>Unbalanced RCA to balanced XLR connections</p> | 1   | Audio ground |
|   | 2   | Signal +     |
|   | 3   | Signal -     |

- ▶ If there is a humming sound from the loudspeaker, activate ground lift to disconnect pin 1 of the ANALOG INPUT socket (XLR) ⑤ from the loudspeaker's chassis ground.



**Connecting AES3 cables**

**Connecting digital signals to the KH 310 D**

**KH 310 D**

- ▶ Connect the digital AES3 or S/P-DIF-output signal of your audio source to the AES3 INPUT socket ⑱ or ⑳ of the respective KH 310 D. See figure below.

**i** The KH 310 D loudspeaker only supports non-encoded AES3 and S/P-DIF signals. Encoded signals such as MP3, DTS or Dolby Digital are not supported.

- ▶ Make an appropriate setting (“DIGITAL A” or “DIGITAL B”) on the SIGNAL SELECT rotary switch ⑰. The setting depends on the signal channel order and the loudspeaker position.

**i** Only one cable is needed for uncompressed AES3 and S/P-DIF digital signals (single-wire mode). They contain two audio channels: “subframe A” and “subframe B”. Usually, the audio channels are:

| Subframe A    | Subframe B     |
|---------------|----------------|
| Left          | Right          |
| Center        | LFE            |
| Surround left | Surround right |
| Back left     | Back right     |

A clock input is not required because loudspeakers are not audio sources and the converters are clocked to a very stable internally generated clock source.

To connect an additional loudspeaker:

- ▶ Use the AES3 OUTPUT socket ⑲. See figure below.
- ▶ Make an appropriate setting (“DIGITAL A” or “DIGITAL B”) on the SIGNAL SELECT rotary switch ⑰.

Set back panel switch to “DIGITAL A”

Set back panel switch to “DIGITAL B”

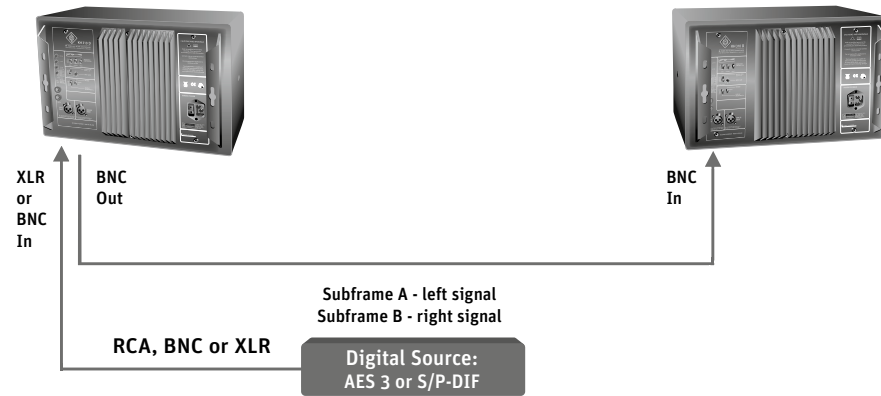



### Connecting multiple KH 310 D loudspeakers together

- ▶ Use the AES3 INPUT ⑱ and OUTPUT socket (BNC) ⑲. T-pieces are not required (see figure below).
- ▶ Make an appropriate setting (“DIGITAL A” or “DIGITAL B”) on the SIGNAL SELECT rotary switch ⑰.

End of the line external termination is not required as the AES3 INPUT socket (BNC) ⑱ already has an internal 75 Ω termination.

Set back panel switch to “DIGITAL A”

Set back panel switch to “DIGITAL B”

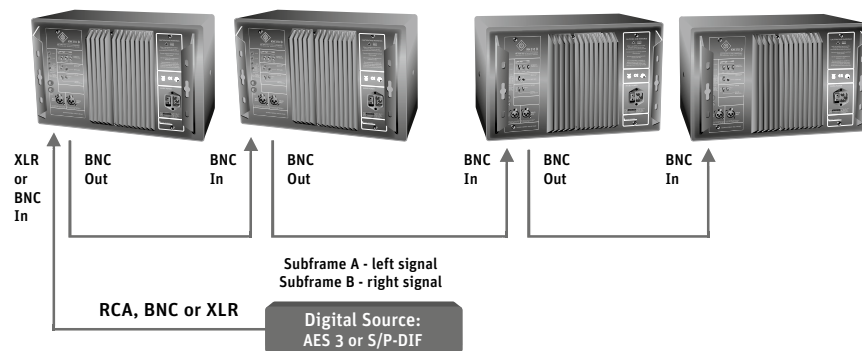

### Setting the SIGNAL SELECT rotary switch ⑰

- ▶ Select one of the following settings, depending on your needs:

| Setting     | Meaning  |
|-------------|--|
| ANALOG      | XLR input socket ⑤   |
| DIGITAL A   | Digital subframe A, AES3 INPUT socket (BNC) ⑱ or AES3 INPUT socket (XLR) ⑳   |
| DIGITAL B   | Digital subframe B, AES3 INPUT socket (BNC) ⑱ or AES3 INPUT socket (XLR) ⑳   |
| DIGITAL A+B | Digital subframe A summed with digital subframe B and a 6 dB attenuation, AES3 INPUT socket (BNC) ⑱ or AES3 INPUT socket (XLR) ⑳ |

Each of these can be selected with and without delay added, so it is very quick to bypass the delay.

The digital output is a buffered copy of the digital input signal which can be used to feed the digital signal onto other loudspeaker or products. There is no digital output from the AES3 OUTPUT socket (BNC) ⑲ when an analog signal is connected to the ANALOG INPUT socket ⑤, therefore the KH 310 D cannot be used as an analog-to-digital converter.

## Connecting/disconnecting the KH 310 to/from the mains power supply

To connect the KH 310 to the mains power supply:

- ▶ Make sure that the on/off switch ⑭ is set to “0”.
- ▶ Connect the IEC connector of the supplied mains cable to the mains socket ⑮.

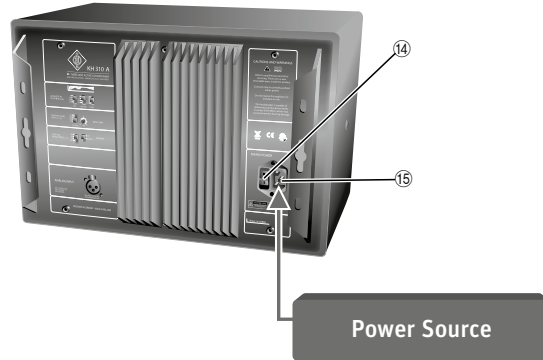

- ▶ Connect the mains plug of the mains cable to a suitable wall socket.

To disconnect the KH 310 from the mains power supply:

- ▶ Set the on/off switch ⑭ to “0”.
- ▶ Pull the mains plug out of the wall socket.

## Configuring and using the KH 310

### Switching the KH 310 on/off



- ▶ Set the on/off switch to:

- “I” to switch on the loudspeaker. The Neumann logo lights up, provided that it has not been switched off by means of the DISPLAY BRIGHTNESS switch ⑦ (see page 18).
- “O” to switch off the loudspeaker. The Neumann logo goes off.



There is an approximate five second delay before sound can be heard from the loudspeaker in order to avoid noises (pops) from preceding equipment switched on at the same time. Conversely, switching off the loudspeaker immediately mutes the audio.

### Adjusting the frequency response

When all its acoustical controls are set to 0 dB, the KH 310 loudspeaker is designed to have a flat frequency response in anechoic conditions. When the loudspeaker is installed in your monitoring environment, the response changes.





The same loudspeaker installed in different positions in the same room may require different acoustical control settings. In a symmetrical installation, left/right pairs (front or back) will probably have the same acoustical control settings.

- ▶ Before using your loudspeaker system for the first time, calibrate the frequency response of the loudspeakers in the room in order to obtain the desired response.
- ▶ Repeat the above step if you change the physical conditions in your studio.
- ▶ At your listening position, determine the frequency response of each loudspeaker.
- ▶ Use the ACOUSTICAL CONTROLS switches ⑩ to adjust the frequency response.

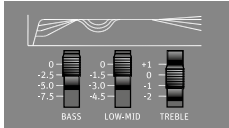

Recommended frequency responses measured at the listening position:

- Studio applications: flat
- Film applications: X-curve shape (see ANSI/SMPTE 202M)
- Home applications: subjective evaluation

| ACOUSTICAL CONTROLS switches ⑩ | Function   | Possible settings    |
|--------------------------------|--|----------------------|
| Bass                           | Compensates for acoustical loading in the low frequency range due to nearby large solid boundaries (e.g. walls).                                   | 0, -2.5, -5, -7.5 dB |
| Low-Mid                        | Compensates for acoustical loading in the low-mid frequency range due to nearby large solid objects (e.g. mixing consoles, desks or flat screens). | 0, -1.5, -3, -4.5 dB |
| Treble                         | Compensates for insufficient or excessive high-frequency damping in the room.  | +1, 0, -1, -2 dB     |

The following settings can be used as a starting point for further adjustment:

| Loudspeaker position                                      | ACOUSTICAL CONTROLS switches ⑩ |         |        |
|---|--------------------------------|---------|--------|
|   | Bass                           | Low-Mid | Treble |
| In a corner   | -7.5 dB                        | -1.5 dB | -      |
| Next to an acoustically solid wall (e.g. brick, concrete) | -5 dB                          | -       | -      |
| Next to an acoustically soft wall (e.g. gypsum)           | -2.5 dB                        | -       | -      |
| Free standing in an untreated room                        | -2.5 dB                        | -       | -1 dB  |
| Free standing in a well-treated room                      | -                              | -       | -      |
| In a small room with strong side wall reflections         | -5 dB                          | 0 dB    | -      |
| Near a small desktop or small reflecting surface*         | -                              | -1.5 dB | -      |
| Near a large desktop or large reflecting surface*         | -                              | -3 dB   | -      |

\* Use these settings in addition to one of the top settings

### Adjusting the acoustical level



- ▶ On your KH 310 loudspeakers, set the OUTPUT LEVEL switch ⑨ to 94 dB SPL and the INPUT GAIN control ⑧ to -15 dB.
- ▶ Play a broadband pink noise test signal that is set to -18 dBFS (Europe) or -20 dBFS (USA) on the mixing console's output level meters.
- ▶ Measure the sound pressure level at the listening position using a sound level meter with the following settings:
  - "C"-weighted
  - slow integration time



- ▶ Set the OUTPUT LEVEL switch ⑨ and the INPUT GAIN control ⑧ of your loudspeakers so that the desired acoustic level is obtained.

Recommended sound pressure levels:

| Application | Sound pressure level        |
|-------------|-----------------------------|
| Film        | 85 dB(C)                    |
| Broadcast   | 79 to 83 dB(C)              |
| Music       | No defined reference levels |

If the Neumann logo flashes red, the loudspeaker’s protection system has been activated. To avoid this and achieve the desired output level, use larger loudspeakers or add a bass managed subwoofer to the system.

Examples of sound pressure levels as a function of the input and output level of the KH 310:

| Input signal<br>[dBu]                   | 0<br>(0.775 V) | 0<br>(0.775 V) | +4<br>(1.23 V) | -20<br>(77.5 mV) |
|---|----------------|----------------|----------------|------------------|
| INPUT GAIN control ⑧<br>[dB]            | 0              | -15            | -4             | -15              |
| OUTPUT LEVEL switch ⑨<br>[dB SPL]       | 100            | 100            | 94             | 114              |
| Sound pressure level<br>[dB SPL] at 1 m | 100            | 85             | 94             | 79               |

### Compensating for video delay (lip sync)

KH 310 D

Signal processing in LCD, Plasma and LED screens, digital projectors with LCD or DLP chips, and video processors used in broadcast centers delays the video signal.

The delay is disturbing when audio leads video by more than 20 ms or lags by more than 40 ms.

To compensate for the video signal delay, the audio signal can be delayed by up to 409.5 ms, which is 10.2 frames at 40 ms/frame or 12.3 frames at 33 ms/frame. The same value should be used for all loudspeakers in the system.

 Please consider the information on latency on page 17.

### Compensating for listening distance differences (time-of-flight)

Loudspeakers placed at different distances suffer from time-of-flight differences which affects imaging. The delay resolution is small enough (0.1 ms) that the delay can be used for time-of-flight adjustment (3.44 cm or 1 3/8" steps).

To compensate for the time-of-flight delay, the audio signal of the KH 310 D can be delayed by up to 409.5 ms, which is 140.87 m (462' 2"). Loudspeakers positioned closer to the listening position should be delayed to be the same as the furthest loudspeaker from the listening distance.

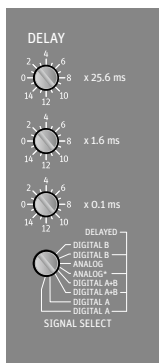



**Example**

Loudspeaker A listening distance: 1.50 m  
 Loudspeaker B listening distance: 1.65 m  
 Time-of-flight difference: 0.15 m

So loudspeaker A should be delayed by the time equivalent of 0.15 m which is 0.436 ms (0.15 m / 3.44 cm x 0.1 ms). The nearest setting of the DELAY rotary switches ⑩ is 0.4 ms, so set the 0.1 ms switch to position 4.

**i** Please consider the information on latency further down.

If a video delay compensation has already been made, add the time-of-flight difference (here: 0.4 ms) to the setting already made.

**Example**

Video delay compensation on loudspeaker A: 2 x 40 ms/frame  
 Desired time-of flight compensation for loudspeaker A: 0.4 ms  
 Time-of-flight compensation: 80.4 ms

This delay value can be made with these switch settings: 3 x 25.6 ms, 2 x 1.6 ms, 4 x 0.1 ms.

**i** The latency of the analog-to-digital and digital-to-analog converters should be taken into account when using the DELAY rotary switches ⑩ for time-of-flight compensation. For the digital-to-analog conversion (input signal via digital connector), the latency is dependent on the sample rate (values can be seen in the Specifications table on page 20). The analog-to-digital-to-analog conversion (input signal via analog connector) is fixed at 0.54 ms.

For time-of-flight compensation delay, calculate the desired delay value then subtract the appropriate latency depending on the input signal and sample rate, and then set the needed additional delay using the delay switches on the back panel.

**Example:**

Distance compensation for 1 m:  $1 \text{ m} / 344 \text{ m/s} = 2,91 \text{ ms}$ : 2.91 ms  
 Digital input signal, sample rate: 48 kHz, latency: 0.85 ms  
 2.06 ms

Delay settings:  
 0 x 25.6 ms, 1 x 1.6 ms, 5 x 0.1 ms  
 (equals 2.1 ms, which is the nearest value)

For video delay compensation, converter latency can be ignored as it is insignificant compared to long video signal delays.

To help with choosing a delay setting there is a set of lookup tables at the end of this operating manual. Also Neumann has made a delay calculator which is available at [www.neumann.com](http://www.neumann.com).

## Activating ground lift

If there is humming or buzzing noise coming from the loudspeaker, first search for the cause of the noise:

- ▶ Disconnect all input and output signal cables from the loudspeaker.

If the noise goes away, it is probably coming from the audio source or source cabling.



It might be possible to eliminate the noise by disconnecting the ground from the input signals (activating ground lift).

To activate ground lift:

- ▶ Reconnect the signal cables and set the GROUND switch ⑥ to “LIFT”. This internally disconnects pin 1 of the ANALOG INPUT socket (XLR) ⑤ from the loudspeaker’s chassis ground (see diagram “Pin assignment of the XLR socket” on page 11).

 For safety reasons, the electronics chassis ground is always connected to the mains power earth pin.

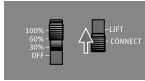

## Adjusting the brightness of the Neumann logo



### WARNING

Danger of hearing damage due to unexpected high sound pressure levels!

If the Neumann logo is switched off, it is not obvious whether the product is switched on or off. In this case, unexpected high sound pressure levels can cause hearing damage.

- ▶ Always set the audio sources connected to the loudspeaker to a low output level before they deliver an audio signal.
- ▶ If you switch off or dim the Neumann logo, mention this to everyone who works with this loudspeaker or the connected audio sources.

To dim or switch off the Neumann logo in low light level environments or when the loudspeaker is placed behind an acoustically transparent screen:

- ▶ Set the DISPLAY BRIGHTNESS switch ⑦ to:
  - “30 %”, “60 %” or “100 %” to adjust the Neumann logo to different brightness levels.
  - “OFF” to switch off the Neumann logo.

 When the loudspeaker’s protection system is active or invalid digital signals are connected to the KH 310 D, the color of the Neumann logo changes from white to red. The brightness of this red limiter indication corresponds to the setting of the DISPLAY BRIGHTNESS switch ⑦ (“30 %”, “60 %” or “100 %”). However, you cannot completely switch off the limiter indication, as it appears with a brightness of 30 % even if the DISPLAY BRIGHTNESS switch ⑦ is set to “OFF”.



## Cleaning and maintaining the KH 310

### CAUTION

Damage to the product caused by liquids!

Liquids entering the product can cause a short-circuit in the electronics and damage or even destroy the product.

- ▶ Keep all liquids away from the product!
- ▶ Before cleaning, disconnect the product from the mains power supply.
- ▶ Use a soft, dry, and lint-free cloth to clean the product. Do not use any solvents or cleaning agents.
- ▶ Clean the cooling fins regularly. They should always be kept free from dust.
- ▶ Never touch the driver diaphragms.



## Troubleshooting

| Problem  | Cause  | Solution  |
|--|--|---|
| The Neumann logo is off, no sound is heard from the KH 310                         | The KH 310's internal main fuse has blown.   | Have the product checked by an authorized Neumann service partner.  |
| The Neumann logo is off or not clearly visible, but sound is heard from the KH 310 | The Neumann logo is switched off or dimmed.  | Switch on the Neumann logo and switch off the dimming (see page 18) .   |
| The Neumann logo is flashing red but there is no sound                             | A DIGITAL signal is selected on the SIGNAL SELECT rotary switch ⑰ but there is no valid audio signal connected to the digital input. | Connect a valid signal to the digital input, check the cabling, or set the SIGNAL SELECT rotary switch ⑰ to ANALOG.                               |
| There is hum or buzz coming from the KH 310 when the audio cable is connected.     | Bad cabling or ground loop in the installation.  | Check all cabling to eliminate the cause of the problem, change from unbalanced to balanced cabling, or use the ground lift switch (see page 16). |

For further information, please refer to the “Questions & Answers” section on the product page at [www.neumann.com](http://www.neumann.com)

## Specifications

| Acoustics   |   |
|---|---|
| Free field frequency response   | 34 Hz to 21 kHz ±3 dB   |
| Pass band free field frequency response   | 36 Hz to 20 kHz ±2 dB   |
| Self-generated noise (INPUT GAIN set to 0 dB, OUTPUT LEVEL set to 100 dB SPL)                     | < 20 dB(A) SPL at 10 cm   |
| Total harmonic distortion < 0.5 % at 95 dB SPL at 1 m   | > 85 Hz   |
| Max. SPL in full space / calc. in half space at 3 % THD at 1 m, averaged between 100 Hz and 6 kHz | 110.3 dB SPL / 116.3 dB SPL   |
| Bass capability:<br>Max. SPL in half space at 3 % THD at 1 m, averaged between 50 Hz and 100 Hz   | 104.5 dB SPL  |
| Max. short term SPL with IEC-weighted noise (IEC 60268-5) at 1 m, in typical listening conditions | 113 dB(C) SPL   |
| Max. short term SPL with music material at 2.3 m, in typical listening conditions (pair)          | 100 dB(C) SPL (full range)<br>107 dB(C) SPL (with subwoofer)                            |
| Max. long term SPL with pink noise at 2.3 m, in typical listening conditions (single/pair)        | 93/99 dB(C) SPL (full range)<br>94/100 dB(C) SPL (with subwoofer)                       |
| Electronics   |   |
| Woofer Class AB amplifier, continuous (peak) output power   | 150 W (210 W), THD and noise <0.1% with deactivated limiter                             |
| Midrange Class AB amplifier, continuous (peak) output power                                       | 70 W (90 W), THD and noise <0.1% with deactivated limiter                               |
| Tweeter Class AB amplifier, continuous (peak) output power  | 70 W (90 W), THD and noise <0.1% with deactivated limiter                               |
| Controller design   | analog, active  |
| Crossover frequencies; crossover slope  | 650 Hz, 2.0 kHz; 24 dB/oct., 4 <sup>th</sup> order                                      |
| Acoustical controls   | Bass: 0, -2.5, -5, -7.5 dB<br>Low-mid: 0, -1.5, -3, -4.5 dB<br>Treble: +1, 0, -1, -2 dB |



|  |   |
|--|---|
| Protection circuitry                                     | Excursion limiter: Low<br>Peak limiter: Low<br>Thermo limiter: Low, Mid, High<br>Overheat protection: Amplifiers  |
| Infrasonic filter frequency; slope                       | 15 Hz; 6 dB/oct.  |
| <b>Analog input</b>                                      |   |
| Input type   | XLR, electronically balanced  |
| Input impedance, XLR balanced                            | > 13 kΩ   |
| Input gain control (sensitivity)                         | 0 dBu to -15 dBu  |
| Output level control                                     | 94, 100, 108, 114 dB SPL  |
| CMRR   | > 56 dB, 100 Hz to 15 kHz   |
| Maximum input level                                      | 24 dBu (ANALOG)<br>18 dBu (ANALOG DELAYED)  |
| <b>Digital input/output (KH 310 D only)</b>              |   |
| Signal format XLR, BNC                                   | AES3, S/P-DIF   |
| Impedance XLR, balanced                                  | 110 Ω (input)   |
| Impedance BNC, unbalanced                                | 75 Ω (input and output)   |
| Input switching  | Analog/Digital A/Digital B/Digital A+B  |
| Digital converter: resolution, design                    | 16 ... 24-bit   |
| Digital converter: sampling rates [kHz]*                 | 22.05, 24, 32, 44.1, 48, 64, 88.2, 96, 176.4, 192   |
| Digital sensitivity                                      | -18 dBFS = 100 dB SPL at 1 m  |
| Dynamic range: A-D-A, D-A                                | > 116 dB(A), 123 dB(A)  |
| THD+N: analog delayed, digital                           | < -104 dB, < -106 dB (typically)  |
| Maximum delay: time / distance                           | 409.5 ms / 140.87 m (462' 2")   |
| Maximum delay: audio-video synchronization (lip sync)    | 10.2 at 40 ms/frame<br>12.3 at 33 ms/frame  |
| Minimum delay resolution: time / distance                | 0.1 ms / 3.44 cm (1 3/8")   |
| Latency D-A (with delay = 0 ms) **                       | 1.84 ms at 22.05 kHz<br>1.70 ms at 24 kHz<br>1.28 ms at 32 kHz<br>0.93 ms at 44.1 kHz<br>0.86 ms at 48 kHz<br>0.64 ms at 64 kHz<br>0.47 ms at 88.2 kHz<br>0.43 ms at 96 kHz<br>0.24 ms at 176.4 kHz<br>0.22 ms at 192 kHz |
| Latency A-D-A (with delay = 0 ms)                        | 0.54 ms   |
| DELAY setting acknowledgement                            | Neumann logo "Red" 1 flash  |
| Digital error /Loudspeaker's protection system is active | Neumann logo "Red" continuous flashes   |
| <b>Product properties</b>                                |   |
| Power consumption (idle)                                 | KH 310 A: 25 W<br>KH 310 D: 30 W  |
| Power consumption (full output AC)                       | 300 W   |
| Dimensions (H x W x D)                                   | 253 x 383 x 292 mm (10" x 15 <sup>1</sup> / <sub>8</sub> " x 11 <sup>1</sup> / <sub>2</sub> " )   |
| Internal net volume/external volume                      | 16.2 l/28.3 l   |
| Weight   | KH 310 A: 13.0 kg (28 lbs 11 oz)<br>KH 310 D: 13.1 kg (28 lbs 14 oz)  |

\* These are the sample rates for which the delay setting value shown on the back panel is valid.

\*\* Depending on the sample rate, this value should be added to the delay setting on the back panel to give the total delay.



|                                     |   |
|-------------------------------------|---|
| Drivers<br>bass, midrange, treble   | magnetically shielded<br>210 mm (8 <sup>1</sup> / <sub>4</sub> " ), 75 mm (3"), 25 mm (1")  |
| Mounting points                     | 2 x M8 thread on side panel, depth 25 mm (1"),<br>Rear panel screws for attaching the LH 41 base plate<br>Mounting holes in the handles |
| Cabinet surface finish, Color       | Painted wood and polyurethane,<br>Anthracite (RAL 7021) or other RAL color.<br>Rear panel: Aluminium, black anodized.                   |
| <b>Operating conditions</b>         |   |
| Ambient temperature                 | +10°C to +40°C (+50°F to +104°F)  |
| Relative humidity                   | max. 90% (non-condensing)   |
| Power supply                        | 100 to 240 V~, 50/60 Hz   |
| <b>Transport/storage conditions</b> |   |
| Ambient temperature                 | -25°C to +70°C (-13°F to +158°F)  |
| Relative humidity                   | max. 90%  |

**Acoustical measurements, block diagram and pin assignment**

Additional technical data such as acoustical measurements, a block diagram and the pin assignment of the XLR socket can be found at the end of this operating manual.

**Accessories**

| Product | Description                        |
|---------|------------------------------------|
| FKH 310 | Flight case for one KH 310         |
| GKH 310 | Metal grille                       |
| LH 25   | Mounting bracket                   |
| LH 28   | Tripod stand adapter               |
| LH 29   | TV spigot (lighting stand adapter) |
| LH 36   | Tilting adapter                    |
| LH 37   | Subwoofer adapter                  |
| LH 41   | Base plate                         |
| LH 43   | Surface mounting plate             |
| LH 45   | Wall bracket                       |
| LH 46   | Adjustable ceiling drop adapter    |
| LH 47   | Mounting adapter plate             |
| LH 48   | Tripod adapter plate               |







**System Block Diagram/System-Blockdiagramm/Synoptique Système/  
Diagrama de Bloques del Sistema**

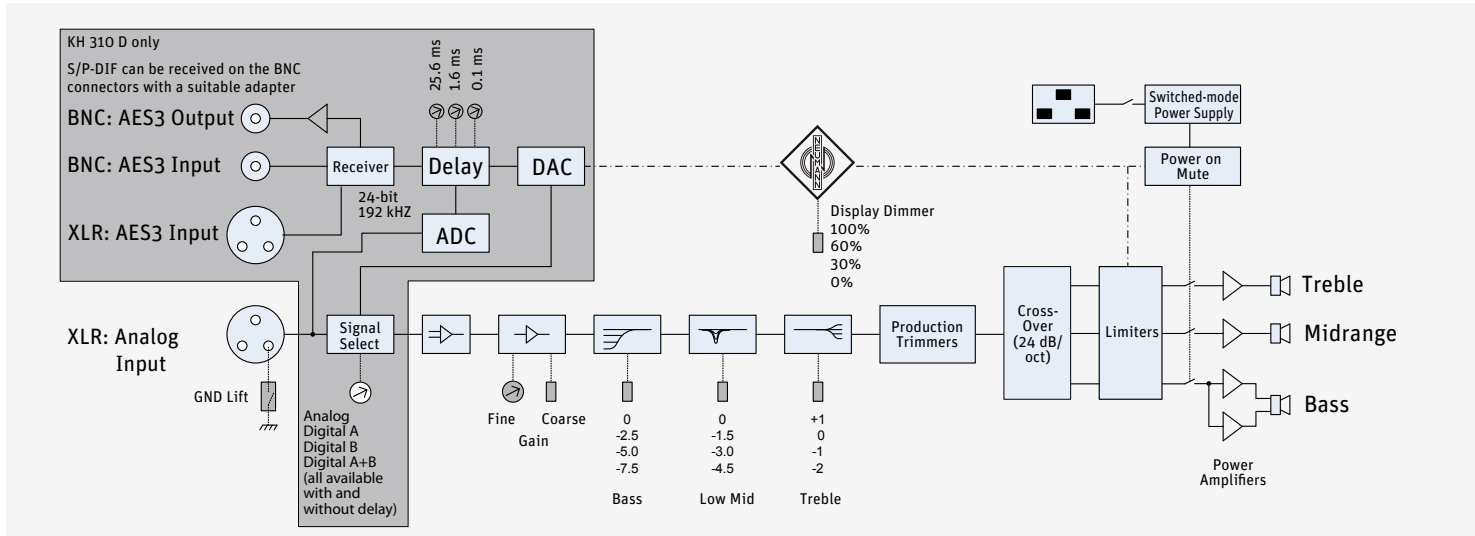

**Pin assignment of the XLR socket/  
Buchsenbelegung XLR/  
Brochage de la prise XLR/  
Asignación de la hembra XLR/**

|   |   |  |
|---|---|--|
| 1 | Audio ground/Audio-Erdung/<br>Masse audio/Toma de tierra de audio |  |
| 2 | Signal +/Signal +/Signal +/<br>Señal +                            |  |
| 3 | Signal -/Signal -/Signal -/<br>Señal -                            |  |

**Acoustical Measurements/Akustische Messungen/Mesures acoustiques/Mediciones Acústicas**

|    |  |
|----|--|
| EN | Below are acoustical measurements conducted in anechoic conditions at 1 m.   |
| DE | Die folgenden akustischen Messungen wurden unter reflexionsarmen Bedingungen bei 1 m Abstand durchgeführt.                                     |
| FR | Vous trouverez ci après les courbes correspondant aux mesures acoustiques effectuées en chambre sourde, à une distance de 1 mètre du moniteur. |
| ES | Las siguientes mediciones acústicas se han realizado bajo condiciones de baja reflexión a una distancia de 1 m.                                |



Free-Field Response | Freifeld-Frequenzgang | Réponse en champ libre | Respuesta en frecuencia en campo libre

Group Delay | Gruppenlaufzeit | Temps de propagation de groupe | Retardo de grupo

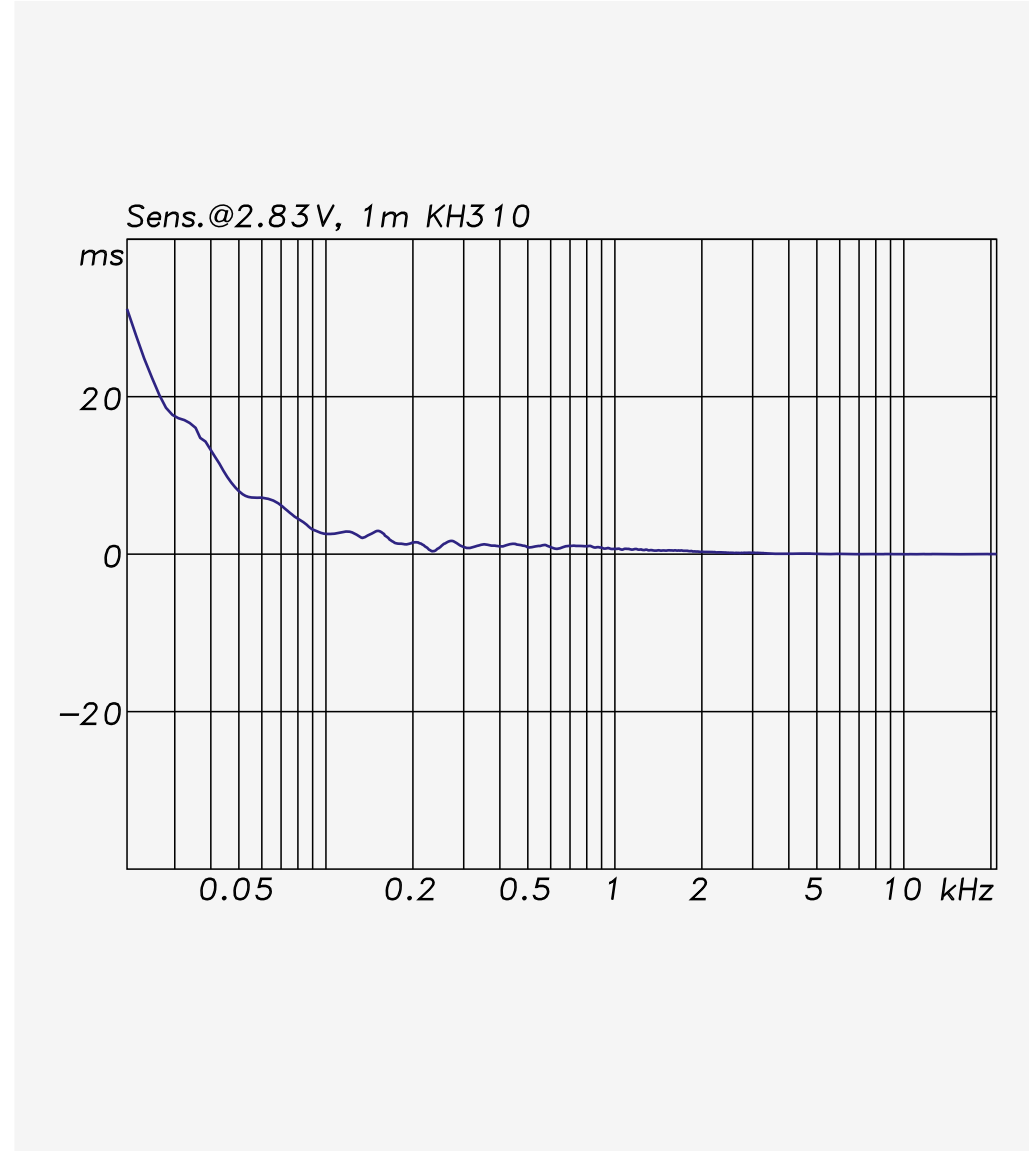
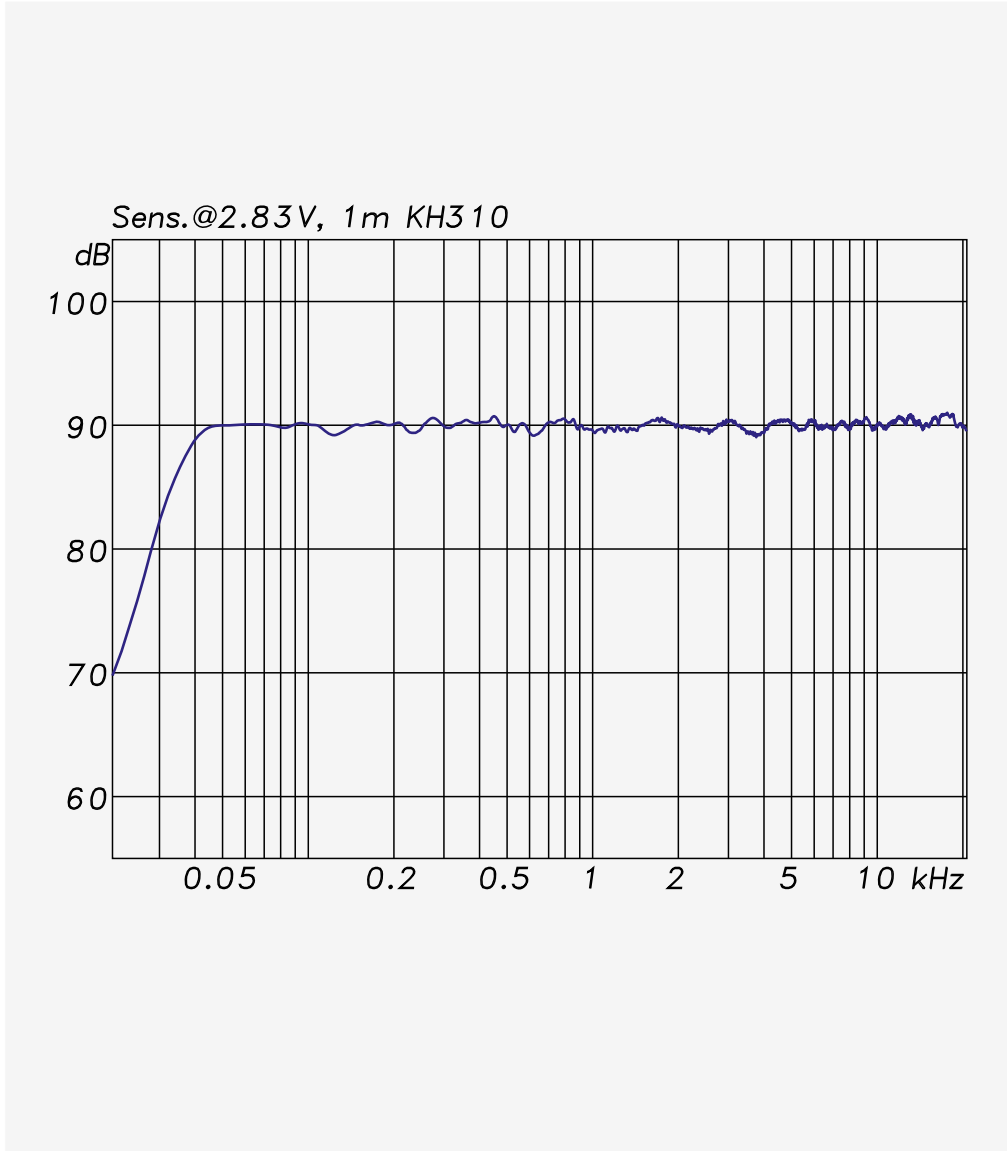



Harmonic Distortion at 90 dB SPL | Klirrfaktor bei 90 dB SPL  
Distorsion harmonique à 90 dB SPL | Distorsión armónica total a 90 dB SPL

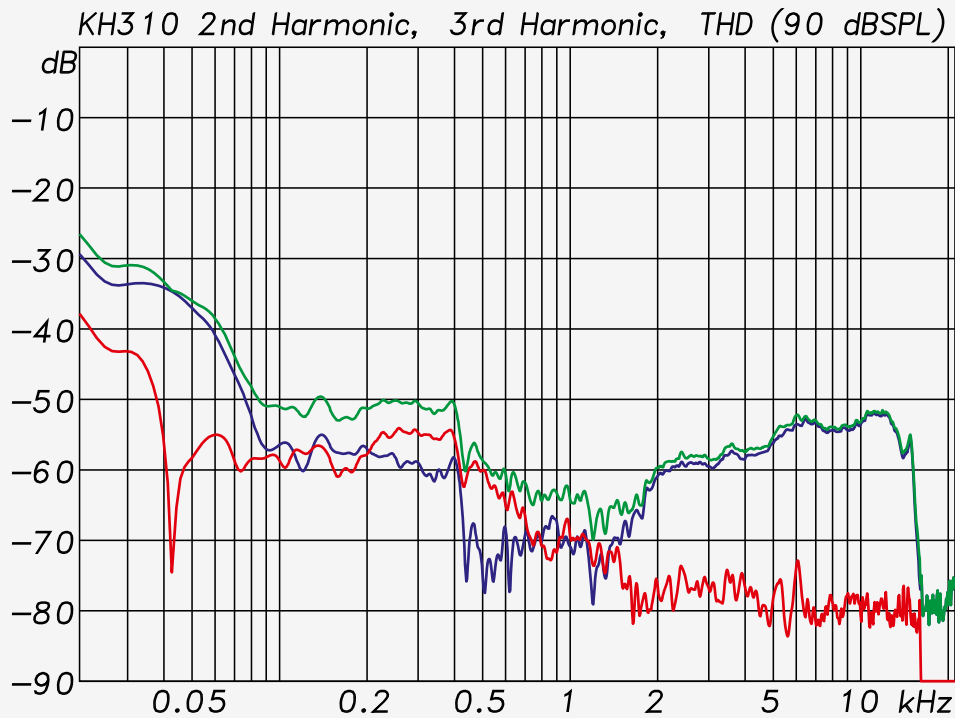

Harmonic Distortion at 95 dB SPL | Klirrfaktor bei 95 dB SPL  
Distorsion harmonique à 95 dB SPL | Distorsión armónica total a 95 dB SPL

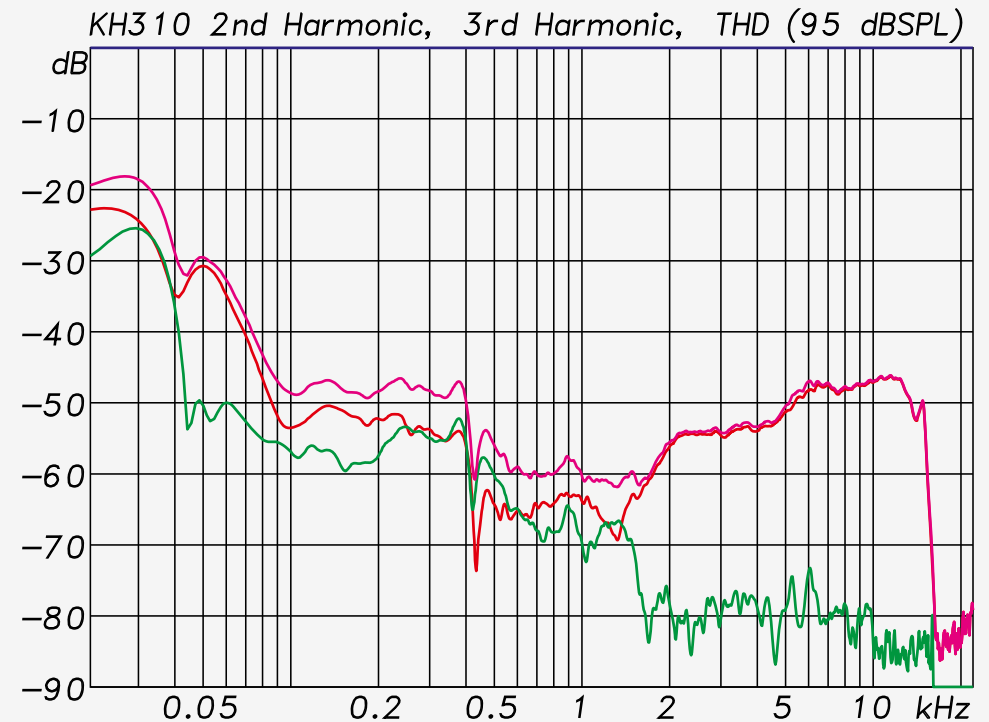



Maximum SPL at 1 m (1 % and 3 %) | Maximaler SPL bei 1 m (1 % und 3 %) | Niveau SPL maximal, à 1 m (1 % et 3 %) | SPL máximo a 1 m (1 % y 3 %)

Acoustical Controls | Akustikregler | Effet des correcteurs de compensation acoustiques | Regulador acústico

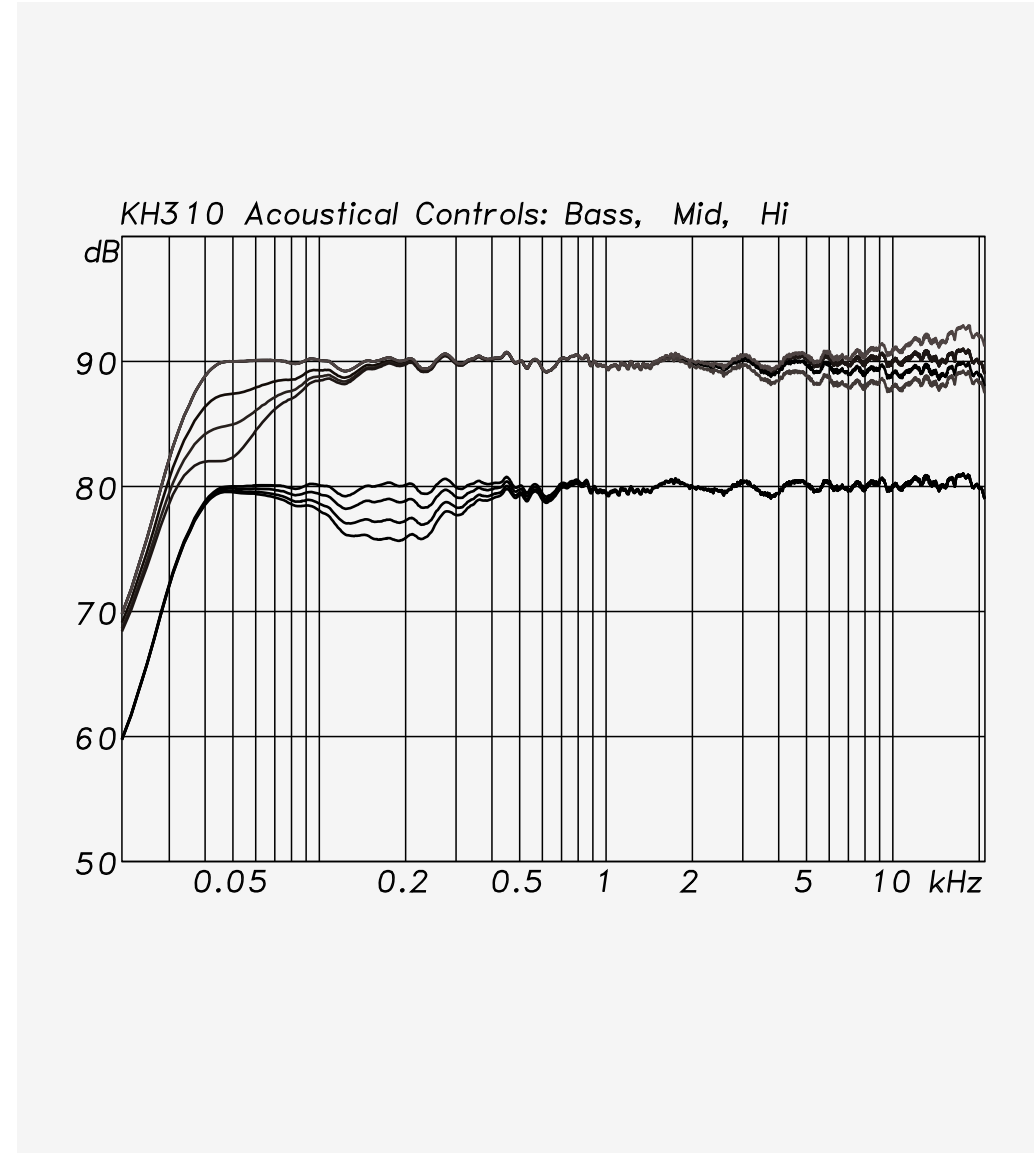
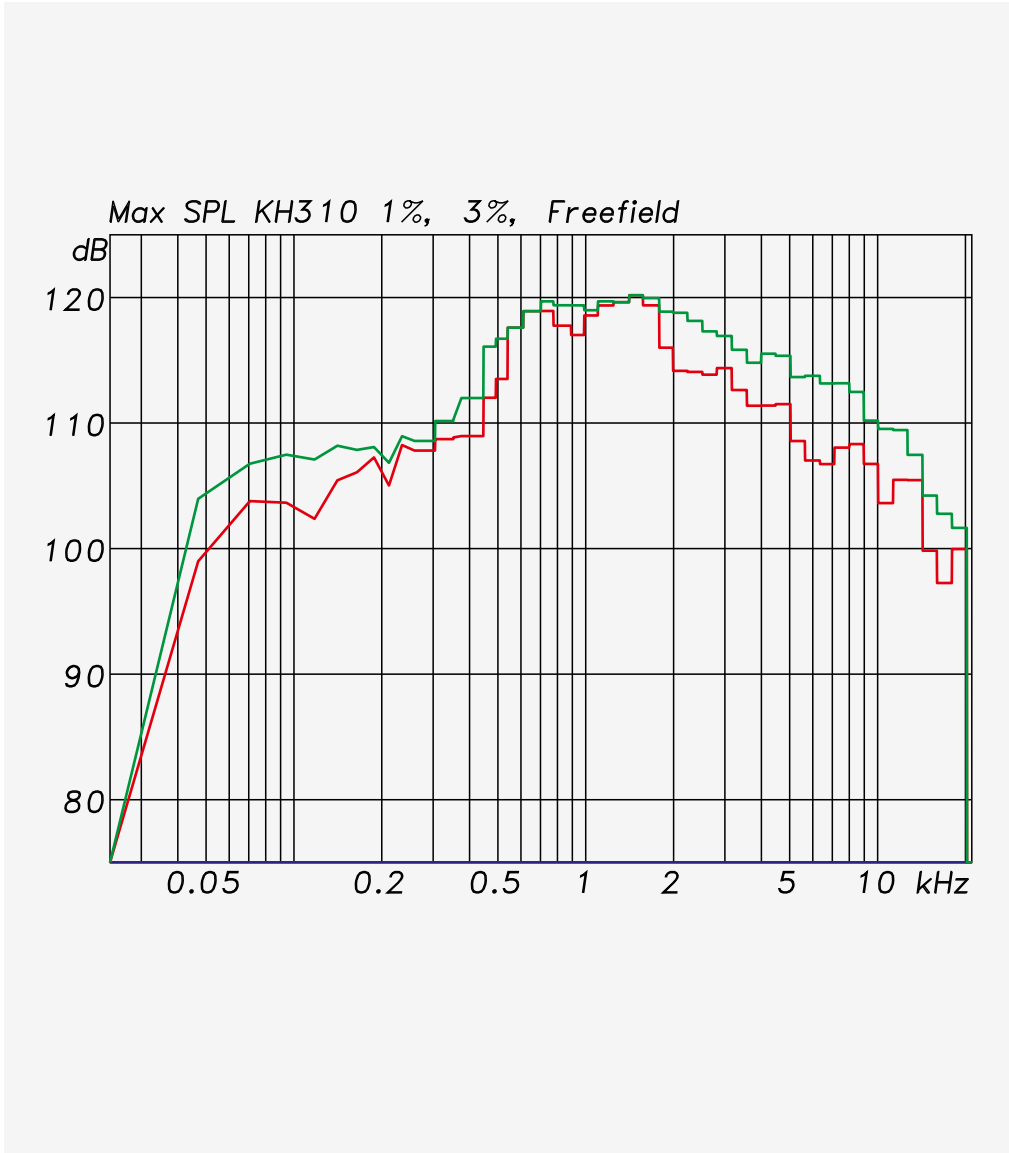



Cumulative Spectral Decay | Zerfallsspektrum |  
Décroissance spectrale cumulée | Caída espectral acumulada

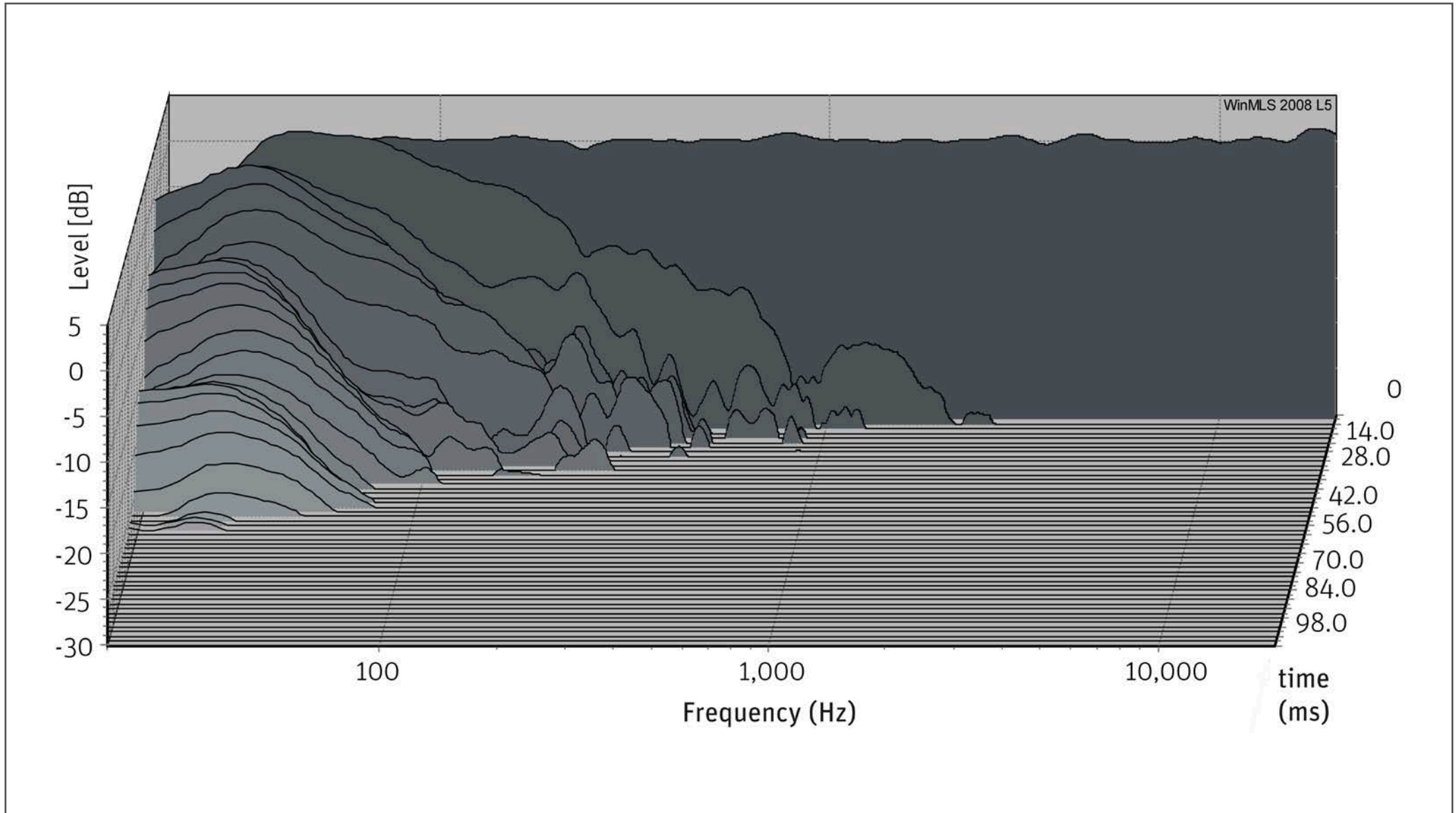



Horizontal Directivity Plot | Horizontales Abstrahlverhalten  
Directivité horizontale | Directividad horizontal

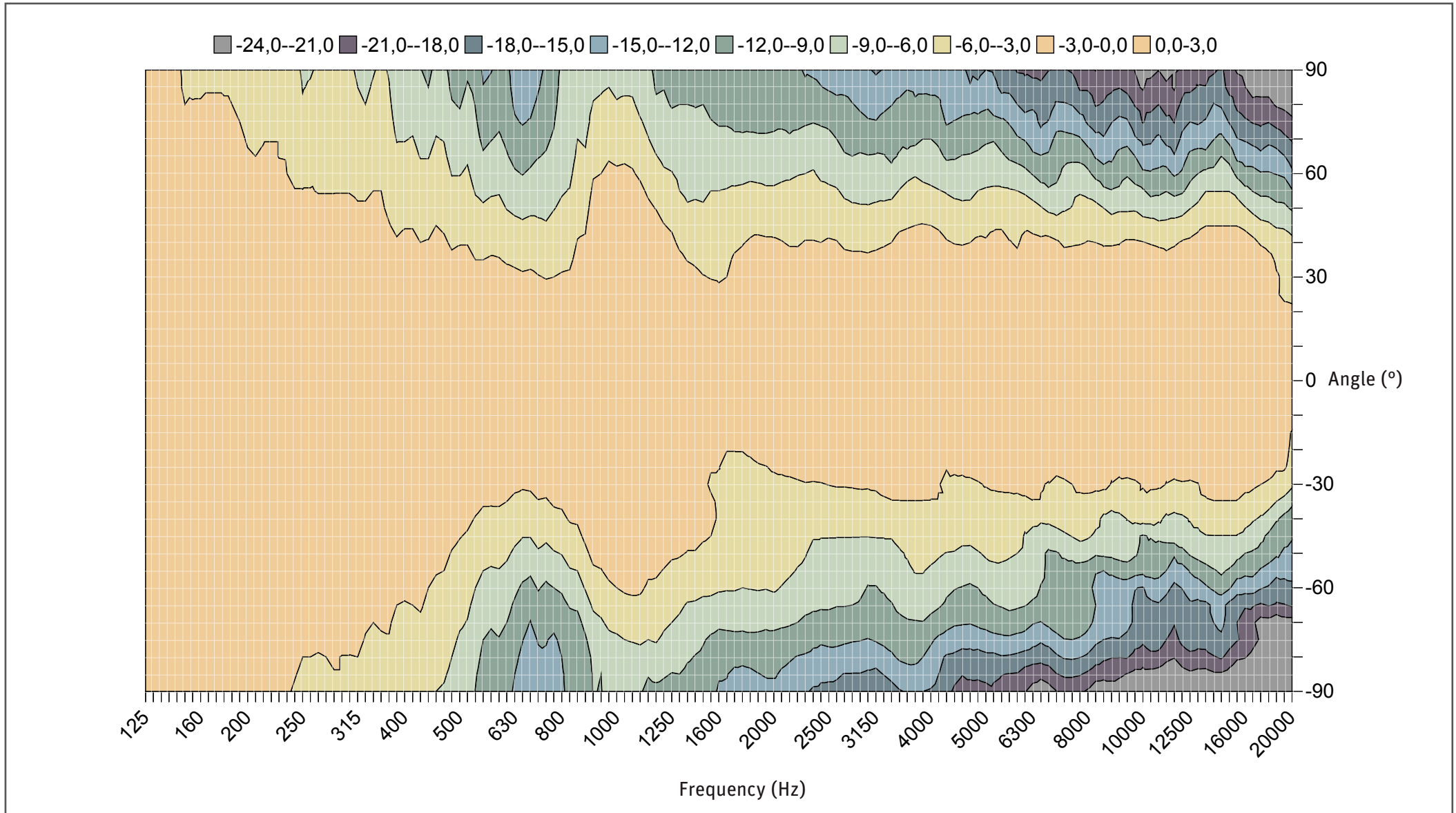



Vertical Directivity Plot | Vertikales Abstrahlverhalten  
Directivité verticale | Directividad vertical

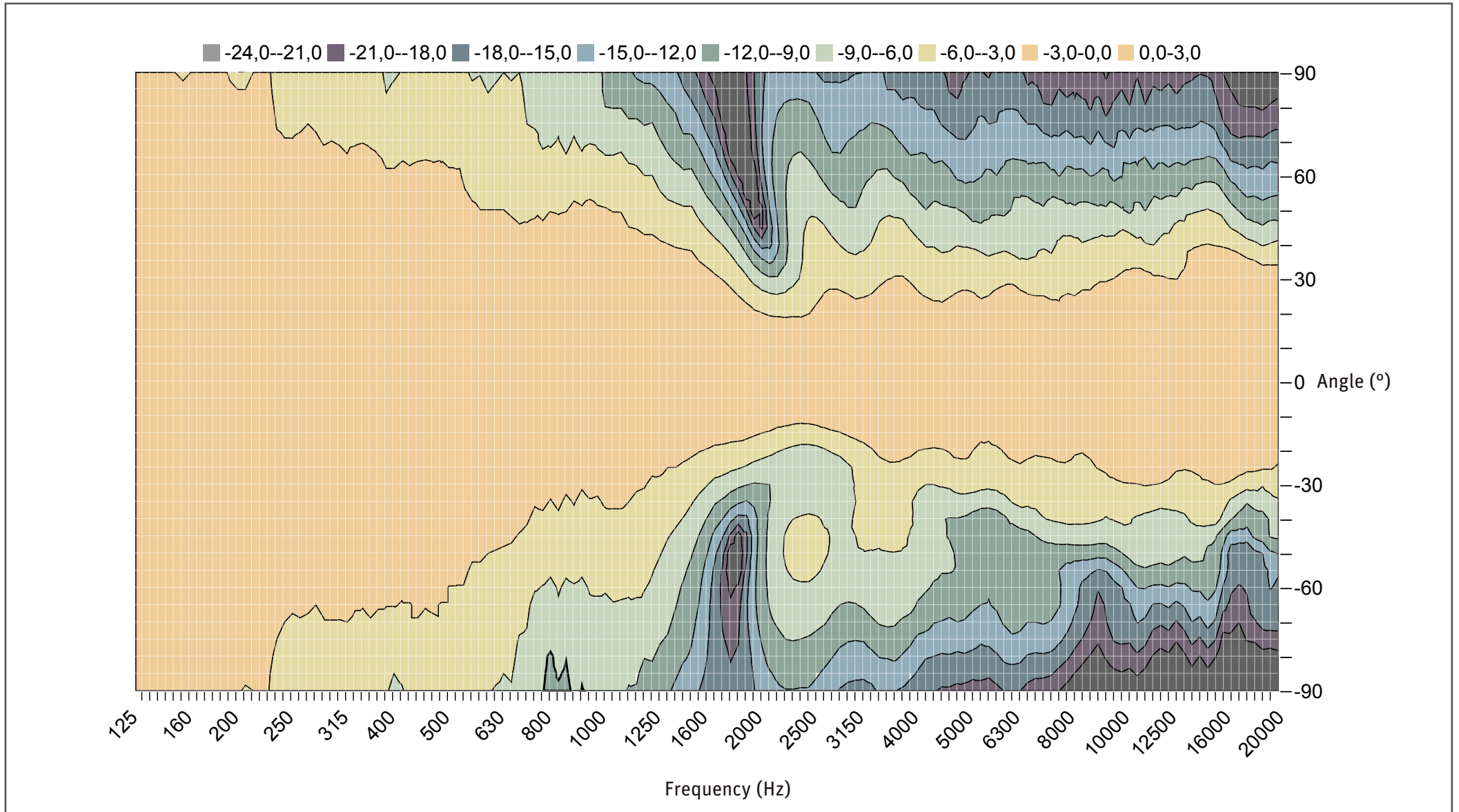



Installation angles/Aufstellwinkel/Angles d'installation/Ángulos de colocación

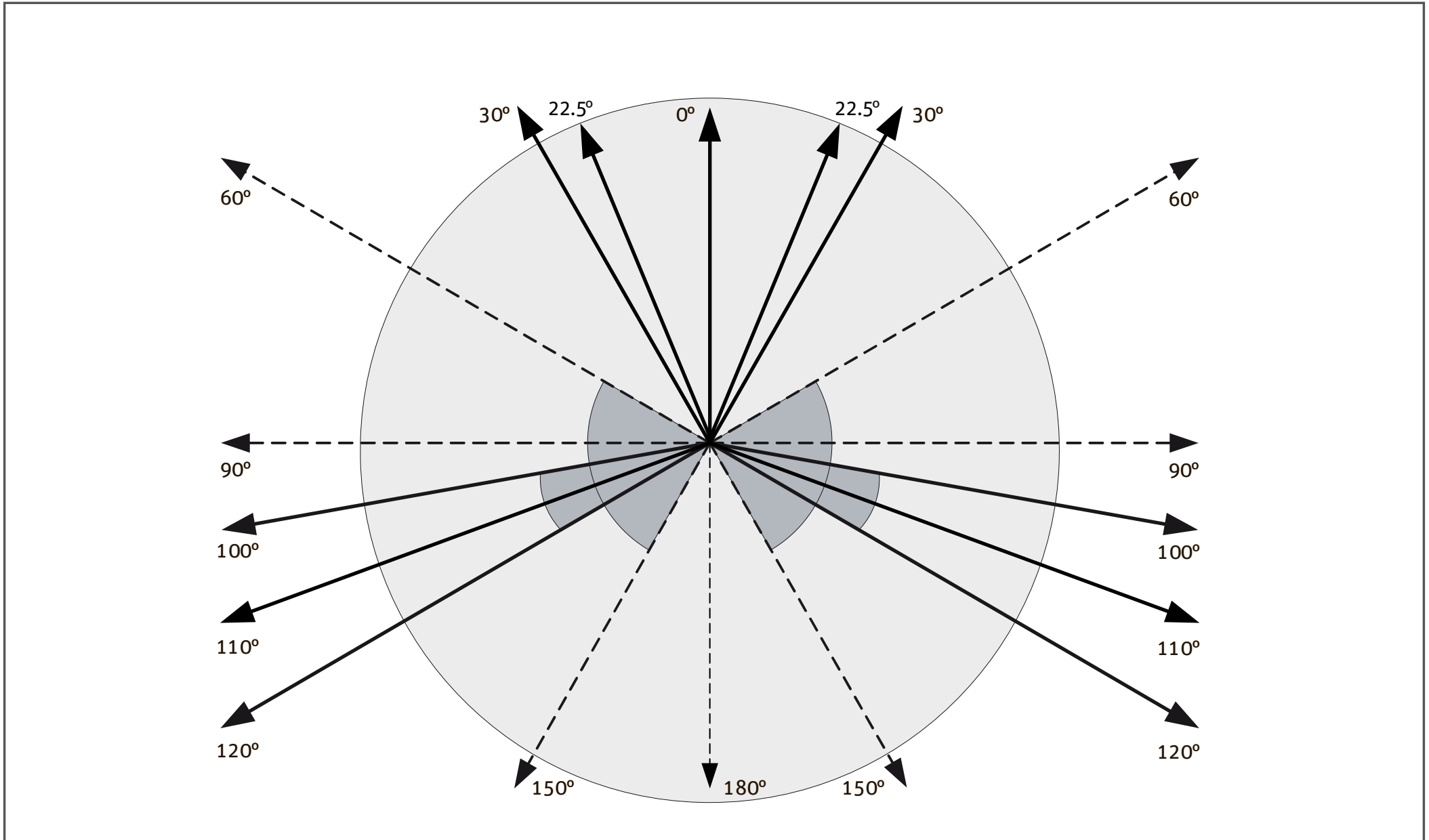





**Digital Delay Lookup Table/Digital Delay Lookup Table/ Digital Delay Lookup Table/Digital Delay Lookup Table**

Switch 1 (25.6 ms)

Switch 2 (1.6 ms)

| Position | Time [ms] | Distance [m] | Distance [Imperial] |          | Frames |       | Time [ms] | Distance [m] | Distance [Imperial] |          | Frames |       |
|----------|-----------|--------------|---------------------|----------|--------|-------|-----------|--------------|---------------------|----------|--------|-------|
|          |           |              | [feet]              | [inches] | 50 Hz  | 60 Hz |           |              | [feet]              | [inches] | 50 Hz  | 60 Hz |
| 0        | 0.0       | 0.000        | 0                   | 0        | 0.0    | 0.0   | 0.0       | 0.000        | 0                   | 0        | 0.0    | 0.0   |
| 1        | 25.6      | 8.806        | 28                  | 11       | 0.6    | 0.8   | 1.6       | 0.550        | 1                   | 10       | 0.0    | 0.0   |
| 2        | 51.2      | 17.613       | 57                  | 9        | 1.3    | 1.5   | 3.2       | 1.101        | 3                   | 7        | 0.1    | 0.1   |
| 3        | 76.8      | 26.419       | 86                  | 8        | 1.9    | 2.3   | 4.8       | 1.651        | 5                   | 5        | 0.1    | 0.1   |
| 4        | 102.4     | 35.226       | 115                 | 7        | 2.6    | 3.1   | 6.4       | 2.202        | 7                   | 3        | 0.2    | 0.2   |
| 5        | 128.0     | 44.032       | 144                 | 6        | 3.2    | 3.8   | 8.0       | 2.752        | 9                   | 0        | 0.2    | 0.2   |
| 6        | 153.6     | 52.838       | 173                 | 4        | 3.8    | 4.6   | 9.6       | 3.302        | 10                  | 10       | 0.2    | 0.3   |
| 7        | 179.2     | 61.645       | 202                 | 3        | 4.5    | 5.4   | 11.2      | 3.853        | 12                  | 8        | 0.3    | 0.3   |
| 8        | 204.8     | 70.451       | 231                 | 2        | 5.1    | 6.1   | 12.8      | 4.403        | 14                  | 5        | 0.3    | 0.4   |
| 9        | 230.4     | 79.258       | 260                 | 0        | 5.8    | 6.9   | 14.4      | 4.954        | 16                  | 3        | 0.4    | 0.4   |
| 10       | 256.0     | 88.064       | 288                 | 11       | 6.4    | 7.7   | 16.0      | 5.504        | 18                  | 1        | 0.4    | 0.5   |
| 11       | 281.6     | 96.870       | 317                 | 10       | 7.0    | 8.4   | 17.6      | 6.054        | 19                  | 10       | 0.4    | 0.5   |
| 12       | 307.2     | 105.677      | 346                 | 9        | 7.7    | 9.2   | 19.2      | 6.605        | 21                  | 8        | 0.5    | 0.6   |
| 13       | 332.8     | 114.483      | 375                 | 7        | 8.3    | 10.0  | 20.8      | 7.155        | 23                  | 6        | 0.5    | 0.6   |
| 14       | 358.4     | 123.290      | 404                 | 6        | 9.0    | 10.8  | 22.4      | 7.706        | 25                  | 3        | 0.6    | 0.7   |
| 15       | 384.0     | 132.096      | 433                 | 5        | 9.6    | 11.5  | 24.0      | 8.256        | 27                  | 1        | 0.6    | 0.7   |



### Digital Delay Lookup Table/Digital Delay Lookup Table/ Digital Delay Lookup Table/Digital Delay Lookup Table

Switch 3 (0.1 ms)

| Position | Time [ms] | Distance [m] | Distance [Imperial] |          | Frames |       |
|----------|-----------|--------------|---------------------|----------|--------|-------|
|          |           |              | [feet]              | [inches] | 50 Hz  | 60 Hz |
| 0        | 0.0       | 0.000        | 0                   | 0        | 0.0    | 0.0   |
| 1        | 0.1       | 0.034        | 0                   | 1        | 0.0    | 0.0   |
| 2        | 0.2       | 0.069        | 0                   | 3        | 0.0    | 0.0   |
| 3        | 0.3       | 0.103        | 0                   | 4        | 0.0    | 0.0   |
| 4        | 0.4       | 0.138        | 0                   | 5        | 0.0    | 0.0   |
| 5        | 0.5       | 0.172        | 0                   | 7        | 0.0    | 0.0   |
| 6        | 0.6       | 0.206        | 0                   | 8        | 0.0    | 0.0   |
| 7        | 0.7       | 0.241        | 0                   | 9        | 0.0    | 0.0   |
| 8        | 0.8       | 0.275        | 0                   | 11       | 0.0    | 0.0   |
| 9        | 0.9       | 0.310        | 1                   | 0        | 0.0    | 0.0   |
| 10       | 1.0       | 0.344        | 1                   | 2        | 0.0    | 0.0   |
| 11       | 1.1       | 0.378        | 1                   | 3        | 0.0    | 0.0   |
| 12       | 1.2       | 0.413        | 1                   | 4        | 0.0    | 0.0   |
| 13       | 1.3       | 0.447        | 1                   | 6        | 0.0    | 0.0   |
| 14       | 1.4       | 0.482        | 1                   | 7        | 0.0    | 0.0   |
| 15       | 1.5       | 0.516        | 1                   | 8        | 0.0    | 0.0   |

