

DriveRack[®]

VENU360

SPEAKER MANAGEMENT SYSTEM

Owner's Manual

- DriveRack VENU360
- DriveRack VENU360-B
- DriveRack VENU360-D

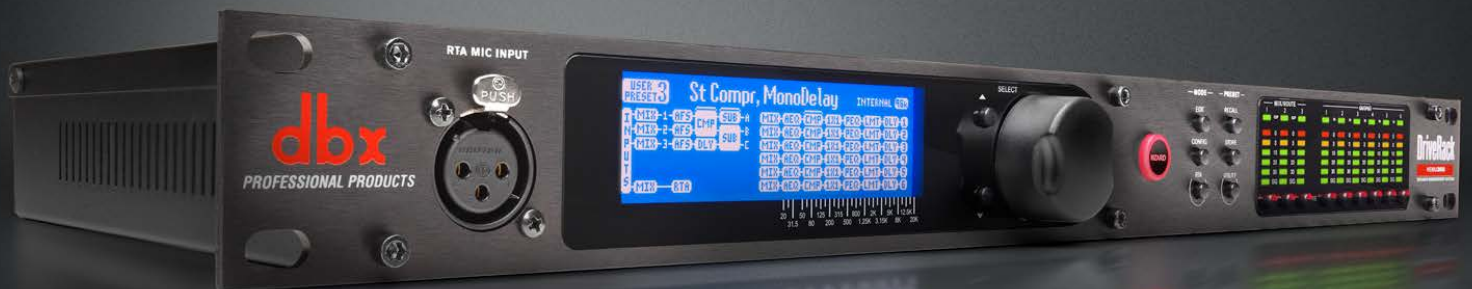

dbx[®]
by HARMAN

Warranty

1. Please register your product online at dbxpro.com. Proof-of-purchase is considered to be the responsibility of the consumer. A copy of the original purchase receipt must be provided for any warranty service.
2. dbx warrants this product, when purchased new from an authorized U.S. dbx dealer and used solely within the U.S., to be free from defects in materials and workmanship under normal use and service. This warranty is valid to the original purchaser only and is non-transferable.
3. dbx liability under this warranty is limited to repairing or, at our discretion, replacing defective materials that show evidence of defect, provided the product is returned to dbx WITH RETURN AUTHORIZATION from the factory, where all parts and labor will be covered up to a period of two years. A Return Authorization Number must first be obtained from dbx. The company shall not be liable for any consequential damage as a result of the product's use in any circuit or assembly.
4. dbx reserves the right to make changes in design or make additions to or improvements upon this product without incurring any obligation to install the same additions or improvements on products previously manufactured.
5. The foregoing is in lieu of all other warranties, expressed or implied, and dbx neither assumes nor authorizes any person to assume on its behalf any obligation or liability in connection with the sale of this product. In no event shall dbx or its dealers be liable for special or consequential damages or from any delay in the performance of this warranty due to causes beyond their control.

Technical Support & Service

If you require technical support, contact dbx Technical Support. Be prepared to accurately describe the problem. Know the serial number of your device – this is printed on a sticker attached to the chassis.

Before you return a product to the factory for service, we recommend you refer to this manual. Make sure you have correctly followed installation steps and operating procedures. For further technical assistance or service, please contact our Technical Support Department at (801) 566-8800 or visit dbxpro.com. If you need to return a product to the factory for service, you MUST first contact our Technical Support Department to obtain a Return Authorization Number.

NO RETURNED PRODUCTS WILL BE ACCEPTED AT THE FACTORY WITHOUT A RETURN AUTHORIZATION NUMBER.

Please refer to the Warranty information, which extends to the first end-user. After expiration of the warranty, a reasonable charge will be made for parts, labor, and packing if you choose to use the factory service facility. In all cases, you are responsible for transportation charges to the factory. If the product is still under warranty, dbx will pay the return shipping.

Use the original packing material if it is available. Mark the package with the name of the shipper and with these words in red: DELICATE INSTRUMENT, FRAGILE! Insure the package properly. Ship prepaid, not collect. Do not ship parcel post.

Table of Contents

| | | | |
|---|-----------|---|------------|
| Overview | 2 | Graphic EQ (GEO) Module..... | 74 |
| Introduction..... | 2 | Noise Gate (GAT) Module..... | 76 |
| Features..... | 3 | Parametric EQ (PEQ) Modules..... | 78 |
| Installation | 4 | AutoEQ (AEQ) Module | 80 |
| Installation Recommendations..... | 4 | Subharmonic Synth (SUB) Module | 82 |
| Making Connections | 4 | Crossover Module..... | 84 |
| User Interface & Connectors | 8 | Limiter (LIM) Module | 86 |
| Front Panel..... | 8 | RTA | 89 |
| Rear Panel..... | 11 | Utility Menu | 92 |
| Getting Started | 13 | Power-Up Functions | 96 |
| Operating Modes Explained..... | 13 | Initialize With Mutes On | 96 |
| The Home Screens..... | 14 | System Lockout..... | 97 |
| Menu Navigation..... | 16 | Soft Reset..... | 98 |
| Configuring The VENU360 | 17 | Factory Reset..... | 98 |
| Using The Wizards (Wizard Mode)..... | 17 | Application Guide | 99 |
| Configuring Inputs, Master Clock Source, & SRC | 20 | Application 1: Full Range Mains | 99 |
| Using Configuration Mode..... | 24 | Application 2: Full Range Mains + Subs..... | 100 |
| Configuring BLU Link / Dante Inputs..... | 26 | Application 3: Bi-Amplified Mains + Aux-Fed Subs..... | 101 |
| Configuring Mixers/Routers..... | 28 | Application 4: LCR Full Range Powered Mains + Subs..... | 102 |
| Configuring Processing Module Insert Types..... | 30 | Application 5: Full Range Stage Monitors..... | 103 |
| Configuring Crossover Types..... | 32 | Application 6: Bi-Amplified Stage Monitors..... | 104 |
| Linking/Unlinking Processing Modules..... | 41 | Application 7: Using The AES Digital Inputs..... | 105 |
| Naming Outputs | 42 | Application 8: BLU Link Application (VENU360-B)..... | 106 |
| Operating The VENU360 | 43 | Application 9: Dante Application (VENU360-D)..... | 109 |
| Editing Processing Module Parameters (Edit Mode) | 43 | Preset List | 110 |
| Copying/Pasting Processing Module Settings..... | 44 | Using The VENU360 Control Application | 113 |
| Managing Presets | 45 | Device Requirements..... | 113 |
| Recalling Presets..... | 45 | Networking | 114 |
| Storing Presets | 46 | Networking Overview | 114 |
| Copying Presets..... | 47 | Network Security..... | 114 |
| Deleting Presets | 48 | Network Troubleshooting | 115 |
| Manually Optimizing A System Using The VENU360 | 49 | Technical Information | 117 |
| About Speaker & Amplifier Tunings..... | 49 | Firmware Updates..... | 117 |
| Manual System Optimization Tips | 50 | DSP Block Diagram | 118 |
| 1. Set Crossover Frequency & Filter Settings..... | 50 | Ethernet Cable Recommendations & Diagrams | 119 |
| 2. Set Driver Alignment Delays, Polarity, & Phase..... | 50 | Audio Cable Diagrams..... | 120 |
| 3. Set Gain Structure & Limiters..... | 52 | Dimensions | 121 |
| 4. Balance The System's Frequency Response | 55 | Specifications..... | 122 |
| 5. EQ The System In The Venue..... | 55 | Additional Resources | 124 |
| 6. Ring Out The System With AFS..... | 56 | | |
| 7. Add Finishing Touches..... | 57 | | |
| Processing Modules & Parameters | 58 | | |
| Inputs Module | 58 | | |
| Router Module | 59 | | |
| Mixer Module..... | 60 | | |
| Advanced Feedback Suppression (AFS) Module..... | 62 | | |
| Automatic Gain Control (AGC) Module | 67 | | |
| Delay (DLY) Modules..... | 69 | | |
| Compressor (CMP) Module..... | 71 | | |

Overview

Introduction

The DriveRack[®] VENU360 represents the next generation of loudspeaker management processing from dbx[®]. With dynamics, EQ, feedback suppression, subharmonic synthesis, crossover, polarity, phase, and delay processing, the VENU360 provides all the processing required for optimizing and protecting Front of House, stage monitor, delay fill, and zone loudspeaker systems.

The VENU360 is perfectly suited for applications such as public address, houses of worship, night clubs, outdoor music events, band rehearsal spaces, theatrical performance venues, touring rigs, or wherever powerful, advanced signal processing, flexibility, and ease-of-use are required for protecting and optimizing a loudspeaker system.

The VENU360 incorporates high-quality 24-bit A/D and D/A converters with dbx Type IV[®] conversion, to protect the incoming audio signal from accidental digital clipping at the A/D stage. 32-bit floating point, 48 or 96 kHz internal processing provides superior audio quality with high internal headroom and wide dynamic range. Built-in sample rate conversion on the two AES input jacks allow the VENU360 to accommodate connections from multiple clocks or AES sample rates other than 48 or 96 kHz.

The VENU360 is a 3x6 signal processor with flexible internal routing and mixing options. With three input processing chains, the VENU360 supports multi-mono, stereo, aux-fed subwoofer, and LCR system configurations. Direct routing capabilities allow additional input signals to be fed to any available output processing chains for additional stage monitor, zone, or delay fill processing – leaving no processing to waste.

There are three VENU360 models available:

- **VENU360 (Standard Model)**

The standard VENU360 model is equipped with 3 XLR input jacks (2 selectable analog/AES jacks plus the analog 3 jack). It is capable of routing or mixing up to 5 inputs simultaneously (4 AES signals and one analog signal). This provides a 5x6 routing/mixing matrix with a 3x6 signal processing chain.

- **VENU360-D (Dante™ Model)**

The VENU360-D model provides all the features of the standard VENU360 model but adds Dante-enabled RJ-45 ports for interfacing with other Dante-equipped devices. It offers a 7x6 routing/mixing matrix (using any available combination of AES, analog, and Dante input channels) and a 3x6 signal processing chain.

- **VENU360-B (BLU link Model)**

The VENU360-B model provides all the features of the standard VENU360 model but with the addition of BLU link-enabled RJ-45 ports for interfacing with other BLU link-equipped devices, such as the dbx TR1616, the PMC16s, the BSS[®] Audio Soundweb London devices, or a Soundcraft[®] mixing console equipped with a BLU link option card. Like the VENU360-D model, the VENU360-B model also provides a 7x6 routing/mixing matrix (using any available combination of AES, analog, and BLU link input channels) and a 3x6 signal processing chain.

The updated Wizards in the VENU360 offer step-by-step assistance with setup configuration, loudspeaker optimization, and feedback elimination. Select your speaker and amp models from the Setup Wizard's tuning list to automatically set speaker and amp tuning parameters and help with calibrating amplifier attenuator controls.

The DriveRack VENU360 incorporates the latest advancements in dbx's proprietary AutoEQ[™] and AFS[®] (Advanced Feedback Suppression) algorithms. Combined with the AutoEQ and AFS Wizards, equalizing and ringing out the entire sound system is made simple. The VENU360 is the first DriveRack to offer AutoEQ on the output processing side (pre crossover), rather than the input processing side. This allows AutoEQ to be used on stage monitors, overflow zones, and delay fills, as well as the Front of House system. In fact, when all outputs are configured with 1x1 crossovers, AutoEQ can be run on each output

independently!

The VENU360 offers network control via the built-in Ethernet port using the free DriveRack VENU360 control application, available for iOS®, Android™, Mac®, and Windows® compatible devices. Now you can adjust loudspeaker management settings from anywhere in the venue! Use the VENU360 control app to connect to the online database, where you can instantly download and apply the latest available tunings from JBL®, Crown®, dbx, and more.

Thanks for choosing dbx. We hope the VENU360 proves to be an invaluable tool for your loudspeaker processing needs.

Features

- *Standard, BLU Link, & Dante Model Versions Available*
- *Up to 5X6 Routing (7X6 With BLU Link or Dante Models) with 3X6 Signal Processing*
- *24-Bit A/D & D/A Converters*
- *dbx Type IV™ Conversion*
- *48 or 96 kHz, 32-Bit Floating-Point Processing*
- *Sample Rate Conversion*
- *Setup Wizard for Easy System Configuration*
- *Level Assist Wizard for System Level Balancing*
- *AutoEQ™ Wizard for Fast & Accurate Room Equalization using 10-Band Parametric EQ*
- *AFS® Wizard for Easy & Accurate Feedback Suppression*
- *Support for Multi-Mono, Stereo, LCR, & Aux-Fed Sub Input Configurations*
- *Selectable 31-Band Graphic EQ or 8-Band Parametric EQ with Narrow Notch Capabilities*
- *Input Delay Processing for Aligning the Sound System to the Stage Backline*
- *Fill Delay Processing for Balcony & Tower Delays*
- *Subharmonic Synthesis for Deep, Punchy Bass*
- *dbx® Compression*
- *Crossover with Support for Full Range up to Mono 6-Way Configurations*
- *Selectable Crossover Filter Types & Slope Rates with Adjustable Polarity & Variable Phase Control*
- *Up to 3000ms Total Cascaded Delay Time (3 Configurable Delay Modules at 1000ms Each)*
- *8-Band Output Parametric EQs for Speaker Tunings*
- *Output Driver Alignment Delays for Multi-Way Systems*
- *dbx PeakStopPlus™ Output Limiters*
- *Built-In Signal Generator & RTA for System Fine-Tuning & Troubleshooting*
- *3 XLR Inputs (Selectable Between 4 AES or 3 Analog Input Channels)*
- *6 Analog XLR Outputs*
- *Front-Panel RTA Mic Input with 48V Phantom Power*
- *Front-Panel Input / Output Mute Buttons*
- *Front-Panel Copy / Paste Functionality*
- *6-Segment Front-Panel Signal Meters with Input Clip & Output Limiter Indicators*
- *Front-Panel Lockout*
- *App Security Lockout*
- *Large, Bright, Easy-To-Read LCD Display*
- *25 Factory / 75 User Presets*
- *Various Speaker & Amplifier Tunings Included*
- *Network Control via the Free VENU360 Control Application for iOS®, Android™, Mac®, & Windows® Compatible Devices*

Installation

Installation Recommendations

FOR RACK MOUNT USE ONLY. Install the VENU360 in your 19" rack with the provided rack screws and washers. When installed in a rack, make sure there is proper ventilation. The sides and back of the device should be free of any obstruction that would prevent airflow. The VENU360 should not be mounted above or below anything that generates excessive heat. Ambient temperatures should not exceed 95° F (35° C) when equipment is in use. Although the unit is shielded against radio frequency and electromagnetic interference, extremely high fields of RF and EMI should be avoided where possible.

Making Connections

Audio Connections

1. Ensure the power is turned off on all interconnecting equipment and the VENU360 before making audio connections.
2. Connect the outputs of the mixing console to the inputs of the VENU360. If connecting a mixer via AES digital connections, use 110 ohm cable optimized for AES transmission. For all analog connections, use the highest quality cables available (preferably balanced) with the shortest possible cable runs. See **'Application Guide' on page 99** for application notes and system diagrams which can be used for reference when connecting the VENU360 to a system. See **'Audio Cable Diagrams' on page 120** for further information on cabling. If connecting a VENU360-B or VENU360-D, connect to the BLU link ring or Dante network using CAT5e or CAT6 Ethernet cables, see **'Ethernet Cable Recommendations & Diagrams' on page 119** for additional information.

TIP: The VENU360 offers selectable analog input and output clip level options, which are available in the Utility menu. These settings allow the analog input and output gain stages to be optimized for the connected analog mixer and amplifiers or powered speakers. See **'ANALOG INPUT/OUTPUT CLIP LEVELS' on page 94** for more information on the analog input and output clip level settings.

3. Connect the VENU360's outputs to the designated amplifier or powered speaker inputs.
4. If you plan to calibrate the system using the built-in Level Assist and AutoEQ Wizards, connect the optional dbx RTA-M measurement microphone to the front-panel RTA Mic Input using a balanced microphone cable of suitable length and place it in a microphone stand.

Applying Power

1. Ensure your power amplifiers or powered speakers are turned off.
2. Connect the included power cable to the AC power inlet on the VENU360's back panel.
3. Apply power to the VENU360 by connecting the other end to an available AC power outlet. Since the VENU360 does not have a power switch, an AC power strip or power conditioner can be used for switching power to the VENU360 on or off.
4. Apply power to your mixer then your power amplifiers or powered speakers.

WARNING: When powering up a fully connected PA system, it is advisable to ALWAYS turn on the mixer and VENU360 first, then turn on your amplifiers or powered speakers last. It's also a good idea to ensure you're not passing audio to the mixer's outputs (or ensure your mixer's master faders are all the way down) before applying power to the amplifiers. When powering down the system, you should ALWAYS power down the amplifiers first, wait about 10 seconds to allow them to discharge, then power down the mixer and VENU360. In short, every time you use your system, the power amps should be the last components turned on and the first components turned off.

Network Connections

To connect directly to a computer:

1. Download and install the free DriveRack VENU360 control app on the iTunes Store®, Google Play™, or from www.dbxpro.com.
2. Connect a crossover CAT5, CAT5e, or CAT6 Ethernet cable (sold separately) to the Ethernet port on the VENU360.

NOTE: A crossover Ethernet cable MUST be used when connecting directly to the computer. A straight-through Ethernet cable will not work! See **'Ethernet Cable Recommendations & Diagrams'** on page 119 for further information on Ethernet cable types.

3. Connect the other end of the Ethernet cable to the Ethernet port on the computer.
4. Apply power to the VENU360 (ensure the amplifiers are powered off, see **'Applying Power'** on page 4 for more information). Wait for the VENU360 to initialize.
5. To configure the VENU360's network settings, press the **UTILITY** button then select the "Network" option.

If your computer is configured for Auto-IP addressing (i.e., the computer's IP address is 169.254.xx.yy):

The default IP address and subnet mask in the VENU360 conform to the Auto-IP addressing standard (i.e., the IP address is 169.254.2.2 and the subnet mask is 255.255.0.0). To connect, simply turn DHCP "OFF" in the VENU360's Utility > Network menu.

If your computer is configured with a static IP address that does not conform to the Auto-IP standard (i.e., something other than 169.254.xx.yy):

Configure the VENU360's network settings to match your computer's network ID and subnet mask settings, see **'Networking Overview'** on page 114 for more information on these network settings.

6. To verify the VENU360's IP address, press the **UTILITY** button then select the "SYSTEM INFO" option or press the **SELECT** wheel from Home mode and select the "SYSTEM INFO" home screen option.

TIP: For more information on networking, including troubleshooting tips, see **'Networking'** on page 114.

Direct Computer Connection

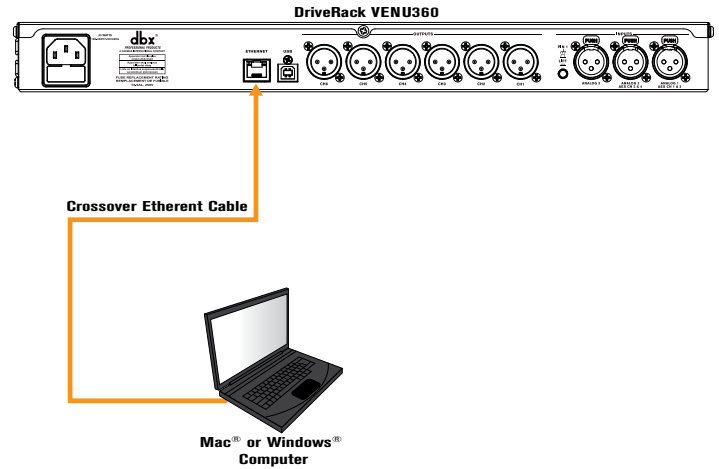

To connect to a wired network switch or router:

1. Download and install the free DriveRack VENU360 control app on the iTunes Store®, Google Play™, or from www.dbxpro.com.
2. Connect a straight-through CAT5, CAT5e or CAT6 Ethernet cable (sold separately) to the Ethernet port on the VENU360.

NOTE: A crossover Ethernet cable can also be used as long as the switch or router is capable of auto-sensing the type of Ethernet cable connected and reconfiguring itself accordingly (referred to as auto-MDI/MDIX sensing).

3. Connect the other end of the Ethernet cable to one of the switch or router's LAN ports.
4. Connect your computer's Ethernet port to one of the other LAN ports on the router or switch using a straight-through CAT5, CAT5e, or CAT6 cable.

NOTE: A crossover Ethernet cable can also be used as long as the switch or router is capable of auto-sensing the type of Ethernet cable connected and reconfiguring itself accordingly (referred to as auto-MDI/MDIX sensing).

5. Apply power to the VENU360 (ensure the amplifiers are powered off, see **'Applying Power'** on page 4 for more information). Wait for the VENU360 to initialize and give it time to negotiate with the network so it can be assigned an IP address – this can take a few minutes. You can ensure the VENU360 has been assigned an IP address by pressing the **UTILITY** button then selecting the "SYSTEM INFO" option or by pressing the **SELECT** wheel from Home mode and selecting the "SYSTEM INFO" home screen option.
6. If connecting using a static IP address, enter the VENU360 Utility menu by pressing the **UTILITY** button. Select the "NETWORK" option then configure the network settings to connect to your network.

TIP: For more information on networking, including troubleshooting tips, see **'Networking'** on page 114.

Wired Network Switch Connection

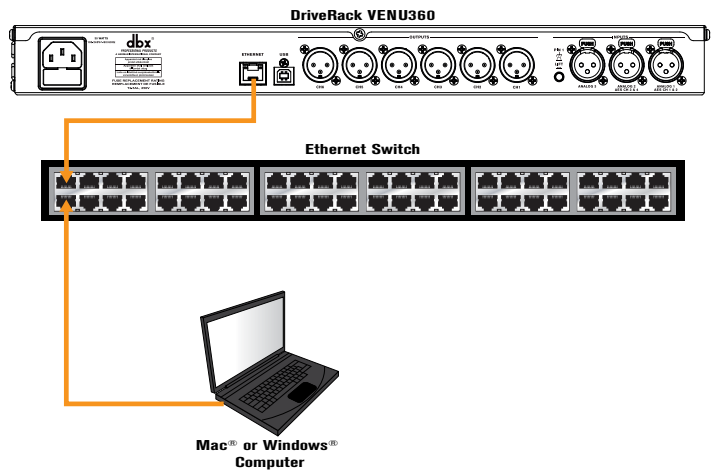

Wired Network Router Connection

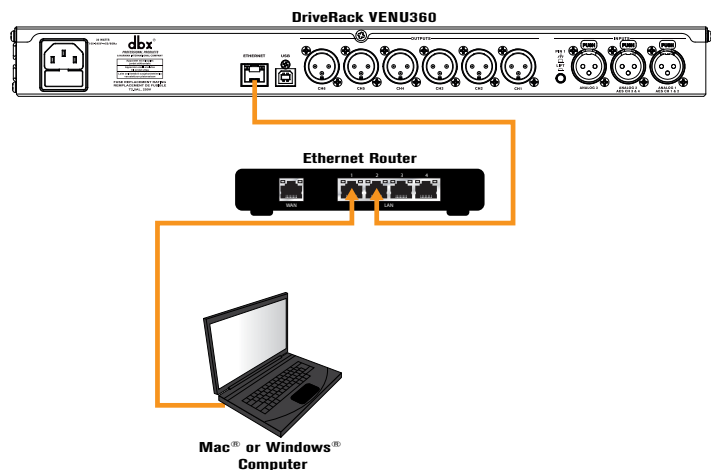

To connect to a Wi-Fi network router:

1. Download and install the free DriveRack VENU360 control app on the iTunes Store®, Google Play™, or from www.dbxpro.com.
2. Connect a straight-through CAT5, CAT5e, or CAT6 Ethernet cable (sold separately) to the Ethernet port on the VENU360.

NOTE: A crossover Ethernet cable can also be used as long as the switch or router is capable of auto-sensing the type of Ethernet cable connected and reconfiguring itself accordingly (referred to as auto-MDI/MDIX sensing).

3. Connect the other end of the Ethernet cable to one of the Wi-Fi router's LAN ports.
4. Connect to the Wi-Fi network using your Wi-Fi equipped computer or device.
5. Apply power to the VENU360 (ensure the amplifiers are powered off, see **'Applying Power' on page 4** for more information). Wait for the VENU360 to initialize and give it time to negotiate with the network so it can be assigned an IP address – this can take a few minutes. You can ensure the VENU360 has been assigned an IP address by pressing the **UTILITY** button then selecting the "SYSTEM INFO" option or by pressing the **SELECT** wheel from Home mode and selecting the "SYSTEM INFO" home screen option.
6. If connecting using a static IP address, enter the VENU360 Utility menu by pressing the **UTILITY** button. Select the "NETWORK" option then configure the network settings to connect to your network.

TIP: For more information on networking, including troubleshooting tips, see **'Networking' on page 114**.

Wi-Fi Network Router Connection

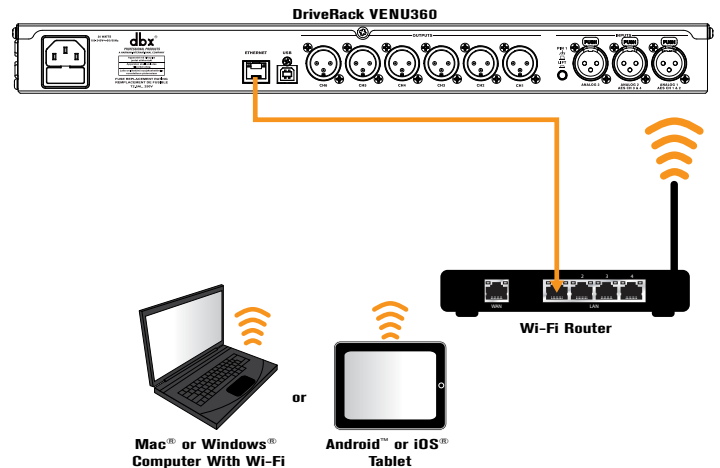

User Interface & Connectors

Front Panel

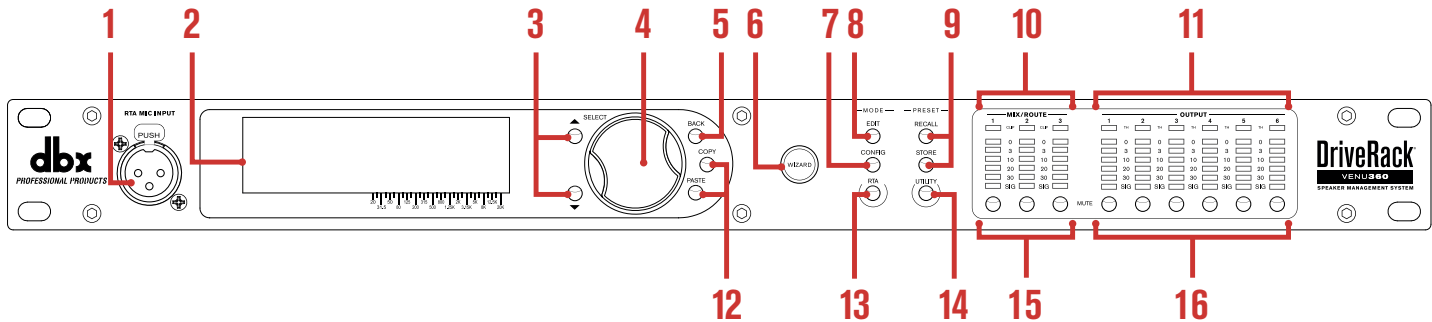

1. RTA MIC INPUT

Connect the dbx RTA-M measurement microphone (sold separately) to this balanced XLR input jack for easy calibration of the sound system using the built-in Wizards or for use with the RTA. This jack supplies +48V phantom power.

2. LCD Display

This LED backlit LCD display provides the visual feedback required for operating the VENU360 processor from the front panel. The LCD's backlight intensity and contrast can be adjusted in the Utility menu, see **'Utility Menu' on page 92** for more information.

3. UP/DOWN Buttons

Pressing the **UP** button will select the on-screen item above the current selection. Pressing the **DOWN** button will select the on-screen item below the current selection. When in Home mode, pressing these buttons will toggle between the available home screens, see **'The Home Screens' on page 14** for more information.

4. SELECT Wheel

This rotary encoder is used for scrolling menus, selecting on-screen options and parameters, and editing selected on-screen options and parameters. Some functions are performed by turning the **SELECT** wheel and others are performed by pressing the **SELECT** wheel. When in Home mode, pressing the **SELECT** wheel will bring up a menu where you can select from the available home screens, see **'The Home Screens' on page 14** for more information.

5. BACK Button

Pressing this button will navigate back one level in the current menu hierarchy. Pressing this button repeatedly will navigate back to the home screen.

6. WIZARD Button

Pressing this button enters the Wizard menu. When in the Wizards, pressing and holding the **WIZARD** button for ~2 seconds will abort the Wizard and return to the main Wizard menu. For more information on the Wizards, see **'Using The Wizards (Wizard Mode)' on page 17**.

7. CONFIG (CONFIGURATION) Button

Pressing this button will enter Configuration mode, where manual changes to the configuration can be made. For more information on using Configuration mode, see **'Using Configuration Mode' on page 24**.

8. EDIT Button

Pressing this button will enter Edit mode. Once in Edit mode, the **UP/DOWN** buttons and **SELECT** wheel can be used to select the desired on-screen processing module for editing or copying and pasting. Pressing and holding this button when in a processing module's edit menu will jump between the selected column's processing edit menus, for fast in-menu navigation of like processing modules. For more information on using Edit mode, see **'Editing Processing Module Parameters (Edit Mode)'** on page 43.

9. PRESET RECALL & STORE Buttons

These buttons are used to store and recall presets. For more information on managing presets, see **'Managing Presets'** on page 45.

10. MIX/ROUTE Meters & CLIP Indicators

These 6-segment LED meters display the input signal level strength and available headroom, and range from SIG (signal present) to 0 (dBFS). These meters monitor the signal level at the 1/2/3 bus points immediately after the input Mixers/Routers (see **'DSP Block Diagram'** on page 118 to see a diagram of the signal flow). They will light when the signal level is greater than or equal to the values shown in the table to the right.

| Input LEDs | dBFS | +14 dBu Analog Gain Setting | +20 dBu Analog Gain Setting | +24 dBu Analog Gain Setting | +28 dBu Analog Gain Setting |
|------------|------|-----------------------------|-----------------------------|-----------------------------|-----------------------------|
| 0 | -0.1 | +14.1 dBu | +20.0 dBu | +24.2 dBu | +28.2 dBu |
| 3 | -3 | +12.2 dBu | +18.2 dBu | +22.2 dBu | +26.3 dBu |
| 10 | -10 | +5.2 dBu | +11.2 dBu | +15.3 dBu | +19.3 dBu |
| 15 | -20 | -4.8 dBu | +1.2 dBu | +5.3 dBu | +9.3 dBu |
| 20 | -30 | -14.8 dBu | -8.8 dBu | -4.7 dBu | -0.7 dBu |
| SIG | -48 | -32.8 dBu | -26.8 dBu | -22.7 dBu | -18.7 dBu |

The LEDs located at the top of the Mix/Route meters are clip indicators. When these LEDs light, it indicates that the VENU360's inputs are being overdriven – either at the physical XLR input or in the input Mixers/Routers. These LEDs feature a peak hold function, so they will remain lit for a short period of time after the signal level drops back below the clip point. The dbx Type IV™ conversion system built into the VENU360 will clamp down on excessively loud input signals to prevent the A/D converters from clipping. If these LEDs light consistently, check to see if any dramatic gains are being applied in the VENU360's input Routers/Mixers. If input Router/Mixer gains are not causing the issue, you may need to change the analog input clip level settings in the Utility menu (see **'Utility Menu'** on page 92 for more information) or lower the output signal level from the sending device.

11. OUTPUT Meters & LIMITER THRESHOLD Indicators

These 6-segment LED meters display the output signal level strength and available headroom and range from SIG (signal present) to 0 (dBFS). These meters monitor the signal level post the output processing and MUTE buttons and before the D/A converters. They will light when the signal level is greater than or equal to the values shown in the following table.

| Input LEDs | dBFS | +4 dBu Analog Gain Setting | +8 dBu Analog Gain Setting | +12 dBu Analog Gain Setting | +14 dBu Analog Gain Setting | +17 dBu Analog Gain Setting | +20 dBu Analog Gain Setting | +22 dBu Analog Gain Setting |
|------------|------|----------------------------|----------------------------|-----------------------------|-----------------------------|-----------------------------|-----------------------------|-----------------------------|
| 0 | -0.1 | +4.5 dBu | +8.6 dBu | +12.4 dBu | +14.3 dBu | +17.2 dBu | +19.8 dBu | +22.1 dBu |
| 3 | -3 | +3.1 dBu | +7.2 dBu | +11.0 dBu | +12.9 dBu | +15.8 dBu | +18.4 dBu | +20.8 dBu |
| 10 | -10 | -3.8 dBu | +0.3 dBu | +4.0 dBu | +5.9 dBu | +8.9 dBu | +11.4 dBu | +13.8 dBu |
| 15 | -20 | -13.8 dBu | -9.8 dBu | -6.0 dBu | -4.1 dBu | -1.1 dBu | +1.4 dBu | +3.8 dBu |
| 20 | -30 | -23.8 dBu | -19.8 dBu | -16.0 dBu | -14.1 dBu | -11.1 dBu | -8.6 dBu | -6.2 dBu |
| SIG | -48 | -41.8 dBu | -37.8 dBu | -34.0 dBu | -32.1 dBu | -29.1 dBu | -26.6 dBu | -24.2 dBu |

The multi-colored threshold LEDs located at the top of the output meters indicate output limiter activity within the corresponding output channels. The three colored states are:

- **Green**
Indicates the signal level is under threshold and no limiting is occurring.
- **Yellow**
Indicates the signal level is in the OverEasy® region and some minor limiting is occurring. This state is only active when the Limiter's "OVER EASY" setting is turned on.
- **Red**
Indicates the signal level has exceeded the Limiter's threshold and full limiting is occurring.

12. COPY/PASTE Buttons

These buttons allow you to copy and paste various parameter settings and processor module types within the VENU360. See **'Copying/Pasting Processing Module Settings' on page 44**, **'Configuring Mixers/Routers' on page 28**, and **'Configuring Processing Module Insert Types' on page 30** for more information on how to use the copy/paste functions.

13. RTA Button

Pressing this button will enter the RTA module. See **'RTA' on page 89** for more information on the RTA.

14. UTILITY Button

Pressing this button enters the Utility menu, where you can get information about the VENU360's firmware and network settings and configure global system settings which dictate how the VENU360 operates. See **'Utility Menu' on page 92** for information on the options and parameters available in the Utility menu.

15. MIX/ROUTE MUTE Buttons

Pressing each of these buttons will enable/disable the "MASTER MUTE" parameter inside each corresponding input Mixer/Router module. When enabled, the signal will be muted prior to the front-panel meters (see **'DSP Block Diagram' on page 118** to see a diagram of the signal flow). The state of these mutes are stored with presets.

16. OUTPUT MUTE Buttons

Pressing each of these buttons will mute the corresponding output channel prior to the limiters and output meters (see **'DSP Block Diagram' on page 118** to see a diagram of the signal flow). The state of these mutes are global and are not stored to presets. However, by default, the state of these buttons will be retained after a power cycle.

The MUTES POWERUP function, available in the Utility menu, lets you configure the VENU360 to always power on with all outputs muted. See **'Mutes Powerup' under 'Utility Menu' on page 92** for more information on this feature.

You can also press and hold any MUTE button upon power up to force the VENU360 to initialize with all outputs muted, see **'Initialize With Mutes On' on page 96** for more information on this feature.

NOTE: All output MUTE buttons are automatically enabled when recalling a preset, applying configuration changes, and after running the Setup Wizard. This is a safety feature. When you're ready to audition or use the system, simply unmute the output channels.

Rear Panel

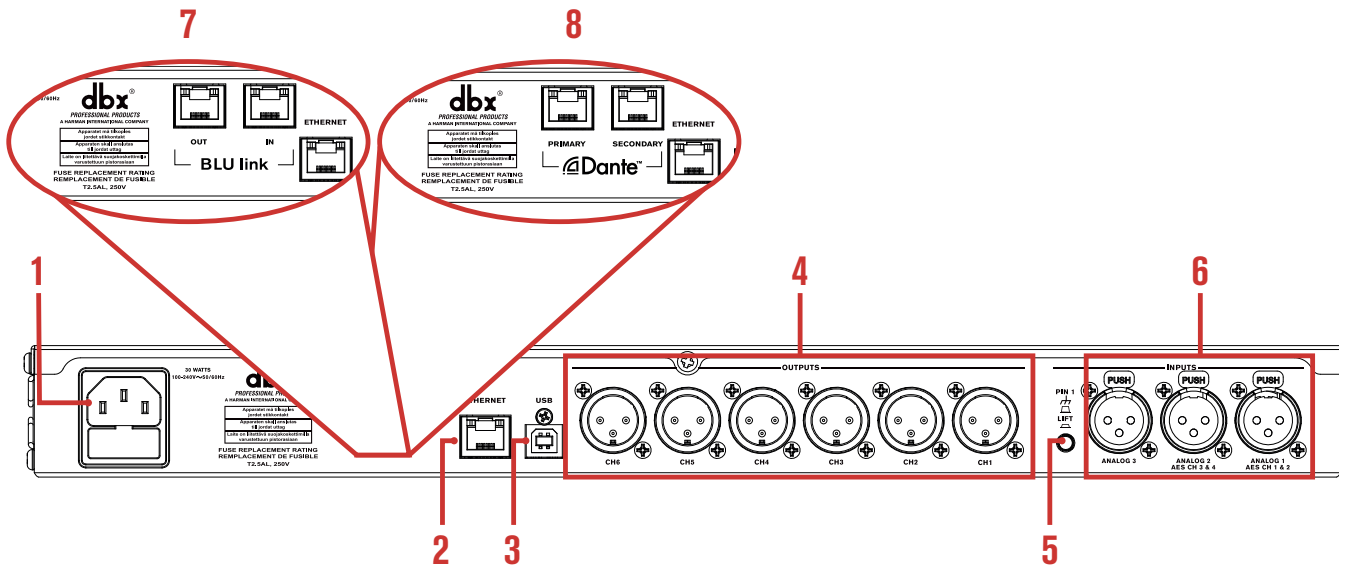

1. AC Power Inlet

Connect the included IEC power cable to this power inlet. The power supply in the VENU360 is a switch-mode power supply and can be operated using a mains voltage of 100-240V, 50Hz/60Hz.

2. Ethernet Port

This RJ-45 connector allows the VENU360 to be connected to a local network and controlled using the free DriveRack VENU360 control app. VENU360 firmware updates can also be performed over this port using the free VENU360 control app. See **'Firmware Updates' on page 117** for more information on firmware updates.

3. USB Port

This USB port provides another way of updating the VENU360's firmware. See **'Firmware Updates' on page 117** for more information on firmware updates.

4. XLR Outputs

These six electronically balanced XLR analog outputs correspond to the output processing chains in the VENU360. The crossovers and output processing chains can be configured for everything from full range up to mono 6-way configurations. Output channel processing modules can be linked with adjacent channels, providing outstanding configuration flexibility.

The maximum analog output clip levels can be adjusted for these outputs in the Utility menu. This can help optimize the analog signal-to-noise performance and gain structure between the VENU360 and amplifiers or powered speakers. See **'ANALOG INPUT/OUTPUT CLIP LEVELS' on page 94** for more information on the analog output clip levels.

If using a VENU360-B or VENU360-D model, the signal sent to each of the XLR outputs will be mirrored to the 6 assigned BLU link or Dante output channels. VENU360-B BLU link output channels can be assigned in the Utility > BLU link menu (see **'Utility Menu' on page 92**) or using the BLU link Setup Wizard (see **'Using The Wizards (Wizard Mode)' on page 17**). Dante output channels in the VENU360-D are assigned using Audinate's Dante Controller software.

5. PIN1 (Ground) Lift Switch

This switch lifts the pin 1 chassis ground on all XLR input connectors. In most applications, this switch should be left in the out (disabled) position. If hum becomes an issue and is caused from a ground loop between your mixer and VENU360, try engaging this switch.

6. XLR Inputs

Connect your mixer to these electronically balanced XLR connectors. The first two XLR connectors can be independently configured for analog or AES digital operation in the Utility menu (see **'Utility Menu' on page 92**) or by running the Setup Wizard (see **'Using The Wizards (Wizard Mode)' on page 17**). Note that 110 ohm balanced cables should be used for AES connections. The third XLR connector is a fixed analog connection.

When using these inputs with analog connections, the input sensitivity can be set in the Utility menu. This can help optimize the analog signal-to-noise performance and gain structure between the mixer and VENU360. See **'ANALOG INPUT/OUTPUT CLIP LEVELS on page 94** for more information on adjusting analog input clip levels.

7. BLU link Ports

Available only on the VENU360-B model, these two RJ-45 ports can be used to connect to other BLU link-enabled devices for transmission and receipt of high-resolution digital audio over Ethernet cable. The VENU360-B supports 8 BLU link input channels x 6 BLU link output channels.

BLU link is a point-to-point digital audio bus with 256 audio channels at a 48 kHz sample rate or 128 audio channels at a 96 kHz sample rate. The physical connections are made with CAT5e or CAT6 cables. The devices are connected in a daisy chain fashion continuing with the OUT port of one device connected to the IN port of the next device.

Redundancy can be provided by completing the loop and connecting the OUT port from the last device to the IN port of the first device in the chain. Do not connect BLU link ports to a hub, network switch, or router – BLU link audio will not pass through such devices. All devices connected in the BLU link ring/chain must be configured for the same audio sample rate.

See **'Application 8: BLU Link Application (VENU360-B)' on page 106** for more information on connecting to the BLU link ports.

8. Dante™ Ports

Available only on the VENU360-D model, these two RJ-45 ports can be used to connect to other Dante-enabled devices for transmission and receipt of high-resolution digital audio over Ethernet cable. The VENU360-D supports 8 Dante input channels x 6 Dante output channels.

Dante is a licensed technology from Audinate®. It uses standard Internet Protocols over a 100Mb or Gigabit network and is capable of transporting professional-quality, low-latency audio. Dante runs on inexpensive off-the-shelf computer networking hardware and does not require dedicated network infrastructure; Ethernet switches transmit Dante digital media streams alongside ordinary data traffic. The physical Dante connections must be made using CAT5e or CAT6 cables when using a Gigabit network (CAT5 may be used for purely 100Mbps networks).

The VENU360-D offers a Primary and a Secondary Dante port; Dante audio traffic is duplicated to both of these ports. The Secondary port can be connected to the network switch for redundant operation in the event the Primary cable connection is compromised.

See **'Application 9: Dante Application (VENU360-D)' on page 109** for more information on connecting to the Dante ports.

Getting Started

Operating Modes Explained

Home Mode

This is the default operating mode. It is the mode the VENU360 enters when it initially boots and is the mode which displays the home screen. There are various home screens to choose from when in Home mode. See **'The Home Screens' on page 14** for more information on each of the available home screens and how to access them.

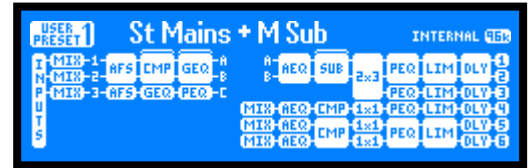

You can get back to Home mode from any menu by repeatedly pressing the **BACK** button. How many times you must press the **BACK** button to return to Home mode is determined by how deeply you have navigated in the current menu.

Wizard Mode

This mode is entered by pressing the **WIZARD** button and walks you through the system configuration and optimization process with step-by-step instructions. See **'Using The Wizards (Wizard Mode)' on page 17** for more information on using the Wizards.

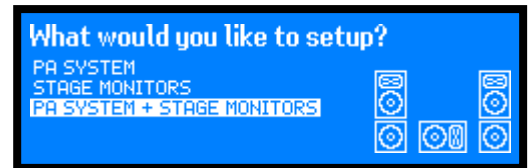

Configuration Mode

Configuration mode is entered by pressing the **CONFIG** button. This mode is used to make manual configuration changes to a preset and to create more-advanced configurations not possible with the Setup Wizard alone.

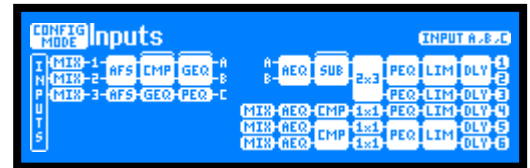

When in Configuration mode, the 'Configuration Mode' icon will appear in the upper left-hand corner of the LCD display and the **SELECT** wheel and **UP/DOWN** buttons can be used to navigate the on-screen configuration map to select a module to configure. As each module is selected, the title at the top of the screen will display descriptive information about it. The icon in the upper-right corner of the display indicates the input/output channels affected by the selected module. Once the desired module is selected, pressing the **SELECT** wheel will present the options available for configuration. See **'Using Configuration Mode' on page 24** for more information on using Configuration mode.

Edit Mode

Edit mode is entered by pressing the **EDIT** button. This mode is used to edit processing module parameters (e.g., Compressor parameters, Crossover parameters, etc.).

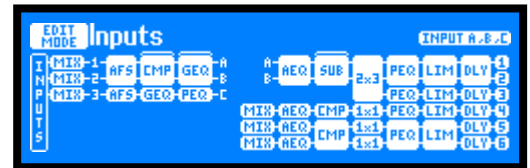

When in Edit mode, the 'Edit Mode' icon will appear in the upper left-hand corner of the LCD display and, just as in Configuration mode, the **SELECT** wheel and **UP/DOWN** buttons can be used to navigate the on-screen configuration map to select a module to edit. As each module is selected, the title at the top of the screen will display descriptive information about it. The icon in the upper-right corner of the display indicates the input/output channels affected by the selected module. Once the desired module is selected, pressing the **SELECT** wheel will enter its menu, where its parameters can be edited. See **'Editing Processing Module Parameters (Edit Mode)' on page 43** for more information on using Edit mode.

The Home Screens

The home screen is the first screen which appears in the LCD display after the VENU360 fully initializes (this mode is referred to as “Home” mode). There are several home screens to choose from, providing the instant visual feedback you need, when you need it. All home screens will display information about the currently loaded preset and clock sync status, as shown in the below callout.

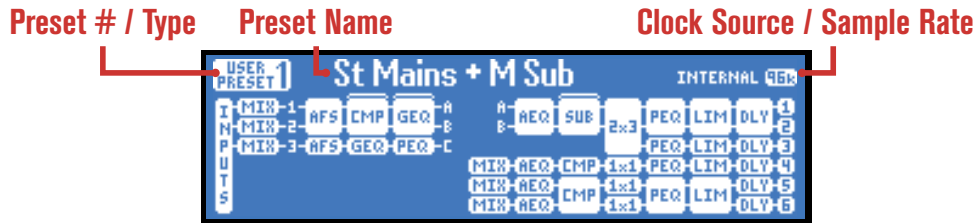

If the preset name is longer than can be displayed on-screen, turning the **SELECT** wheel allows you to scroll the preset name and view the additional characters.

Home screens can be accessed by pressing the **SELECT** wheel and selecting the desired home screen from the pop-up menu or pressing the **UP/DOWN** buttons. Following is a description of each available home screen.

Configuration Map Home Screen

This is the default home screen. This screen shows the configuration and signal flow of the currently loaded preset. The left of the screen indicates the input processing configuration. The right of the screen indicates the output processing configuration. The blocks represent the processing modules. The brackets located at the top of some columns indicate configurable processing insert slots.

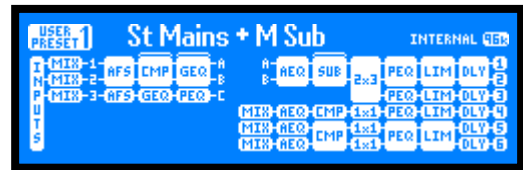

Configuration Map Home Screen

Dynamics Gain Home Screen

This home screen shows a global view of all gain changes applied by any configured dynamics processors (i.e., Compressors, Limiters, AGCs, and Noise Gates). Any insert slots configured as anything other than a dynamics processor will be represented by a bubble indicating the processor type with a line displayed where a gain meter would otherwise reside.

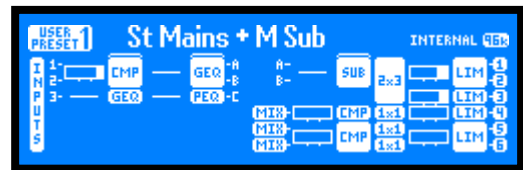

Dynamics Gain Home Screen

Dynamics Threshold Home Screen

This home screen shows a global view of the threshold indicators for all configured dynamics processors (i.e., Compressors, Limiters, AGCs, and Noise Gates). Any insert slots configured as anything other than a dynamics processor will be represented by a bubble indicating the processor type with a line displayed where a threshold indicator would otherwise reside. For information on the meaning of each of the threshold indicators shown in this home screen, see the Compressor, Limiter, AGC, and Noise Gate Module sections under **‘Processing Modules & Parameters’ on page 58**.

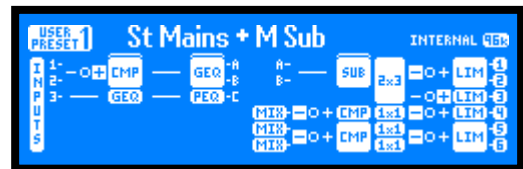

Dynamics Threshold Home Screen

RTA Home Screen

This home screen provides quick access to the Real-Time Analyzer. The graphic to the left of the RTA displays the signal source feeding the RTA, which is set with the RTA SOURCE parameter in the RTA menu. See **'RTA' on page 89** for more information on the RTA menu and parameters.



RTA Home Screen

Input Meters Home Screen

This home screen displays the signal level and clip indicators for all VENU360 inputs.

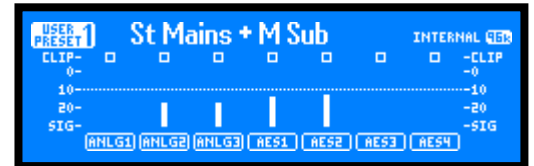

Input Meters Home Screen

Bus Meters Home Screen

This home screen displays metering for all bus points in the input signal path (i.e., 1, 2, 3, A, B, and C). The 1/2/3 bus points are pre the input signal processing chains. The A/B/C bus points are post the input processing chains. See **'Configuring Mixers/Routers' on page 28** and **'DSP Block Diagram' on page 118** for more information on these bus points.

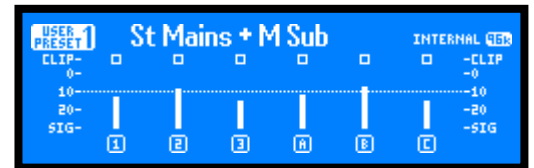

Bus Meters Home Screen

System Info Home Screen

This home screen shows the name of the VENU360 device, currently installed firmware version, and current IP status/address.



System Info Home Screen

Dante Info Home Screen

This home screen is available in the VENU360-D model and shows Dante connection information at a glance. The port connection icons on the right of the screen will show whether each Dante port is connected or disconnected. Additional Dante information can be found in the Utility menu, see **'DANTE' on page 93** for more information.

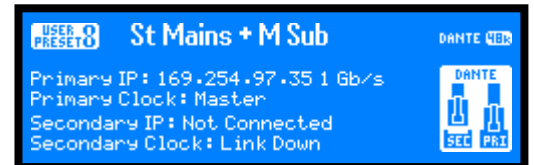

Dante Info Home Screen

BLU Link Info Home Screen

This home screen is available in the VENU360-B model and shows BLU link connection information at a glance. The port connection icons on the right of the screen will show whether each BLU link port is connected, disconnected, or connected with an issue (an "X" will appear in the connection icon if there is a connection issue). Additional BLU link information can be found in the Utility menu, see **'BLU LINK' on page 92** for more information.

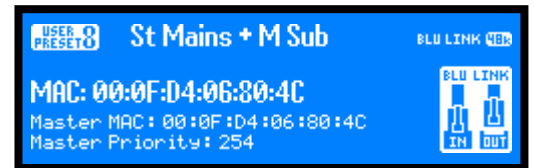

BLU Link Info Home Screen

NOTE: After a power cycle, the VENU360 will return to the home screen selected before the unit was powered down.

NOTE: The HOME TIME OUT feature in the Utility menu will determine if the VENU360 will return to the home screen after a period of inactivity and how long it will wait before timing out. See **'HOME SCREEN TIME OUT' on page 95** for further information on the HOME TIME OUT feature.

Menu Navigation

The VENU360 menu navigation is laid out as shown in the below diagram.

Menu Navigation Tree Diagram

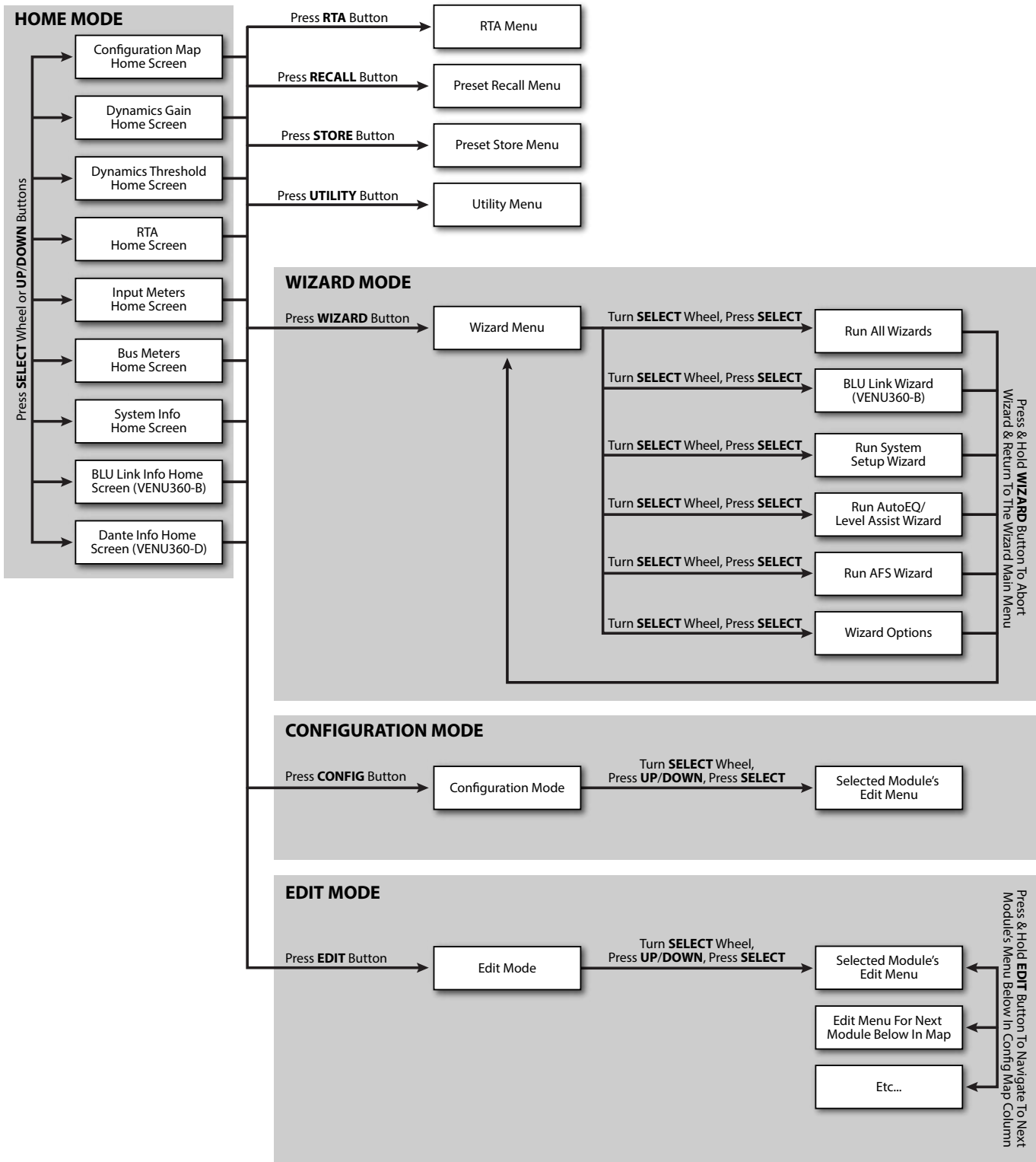

Configuring The VENU360

There are two ways to configure the VENU360: using the Setup Wizard or using Configuration mode. For some applications, both methods may be required.

The easiest way to configure the VENU360 is to use the built-in Setup Wizard. This works well for configuring most systems, including stage monitors and PA systems with crossover configurations from full range up to mono 4-way (3-way main speakers with subs). It also works well for initially configuring the VENU360 for delay fill and zone applications. However, some applications will require further customization of the configuration using Configuration mode. This section of the manual describes how to use the Wizard and Configuration modes in more detail.

Using The Wizards (Wizard Mode)

The VENU360 Wizards walk you through the configuration and optimization process with simple, step-by-step instructions, making it easy to setup the VENU360 for your application. Using the optional dbx RTA-M measurement microphone, the Wizards can optimize your sound system by helping adjust your system level balance and analyzing your room and applying accurate room EQ – in a fraction of the time it would take to manually analyze and calibrate the system!

To use the Wizards to configure and optimize a new system:

| | |
|--|--|
| <p>1. Press the WIZARD button.</p> | |
| <p>2. Select the “RUN ALL WIZARDS” option using the SELECT wheel.</p> | |
| <p>3. Follow the on-screen instructions. Turn the SELECT wheel to edit on-screen selections and press the SELECT wheel to confirm on-screen selections and advance through the Wizards.</p> | |

TIP: Pressing and holding the **WIZARD** button for ~2 seconds at any time during the Wizard procedure will abort the current Wizard and return to the main Wizard menu.

Following is a description of each of the available options in the VENU360’s Wizard menu.

Run All Wizards

Select this option to run through all Wizards in succession. Note that there are points where you do have the option to opt out of the AutoEQ and AFS Wizards if necessary.

Run BLU link Setup Wizard (VENU360-B Only)

Running the BLU link Setup Wizard walks you through the process of configuring a VENU360-B for connection with other BLU link-enabled devices, this includes BLU link sample rate, input channel assignments and names, and output channel

assignments. All of these settings can also be edited manually in the Utility > BLU link menu. See **'BLU LINK' on page 92** for further information on the BLU link menu.

Run System Setup Wizard

This Wizard allows you to select your speaker and amplifier models from a tuning list and automatically sets the crossover, output parametric EQ, driver alignment delay, polarity, analog output clip levels, and limiter settings if your speaker and amp models are listed. If your components are not listed, check the cloud using the VENU360 control app to see if they've been added. If they haven't been added, select the "Not Listed??" option – default settings will still be set to get you started. This Wizard will also configure the XLR inputs for analog or AES operation and the master clock source.

TIP: If re-configuring a preset which was initially configured using the Setup Wizard, you will receive a prompt asking if you would like to, "Start from default settings?". Select the "YES" option to default the Setup Wizard settings and start from scratch. Selecting the "NO" option will present the Setup Wizard with the options selected when initially running the Setup Wizard to create the preset. Note that if you're updating a preset by re-running the Setup Wizard – for example, if you've upgraded amps or speakers – any changes that were made to the preset in Configuration mode or to processing module settings will be lost! Therefore, it's recommended that you first copy your stored preset to another memory location before re-running the Setup Wizard. This way you can use the original preset for reference and copy/paste processing module settings from the original preset to the new preset.

Run AutoEQ/Level Assist Wizard

When used with the optional dbx RTA-M measurement microphone, these Wizards help you balance speaker levels and automatically equalize the system to the current room environment.

The diagrams to the right show the recommended Level Assist and AutoEQ RTA-M mic positions. When running AutoEQ, you will be prompted to select how many mic positions you would like AutoEQ to analyze – the selections are 2, 3, or 4.

The Level Assist and AutoEQ mic position 1 measurements should be taken with the microphone placed equidistant from the speakers, so that the three components form an equilateral triangle, as shown in the Level Assist/AutoEQ Mic Position 1 diagram. If analyzing a mono speaker, place the mic in the position that makes the most sense. For example, if analyzing a stage monitor, place the mic in the location where the artist monitoring the signal will be.

Each time you move the RTA-M mic position it should move approximately 1/3rd the distance the speakers are apart from the initial "RTA-M Mic Placement 1 Reference", as shown in the AutoEQ Mic Position 2-3 diagrams. If analyzing a mono speaker, move the mic by around 1-2' in the same direction shown in the diagrams.

Mic position 4 is the exception as it should be placed 2/3rds the distance from the RTA-M Mic Placement 1 Reference. If analyzing a mono speaker, move the mic by a distance of around 3' in the same direction shown in the diagram.

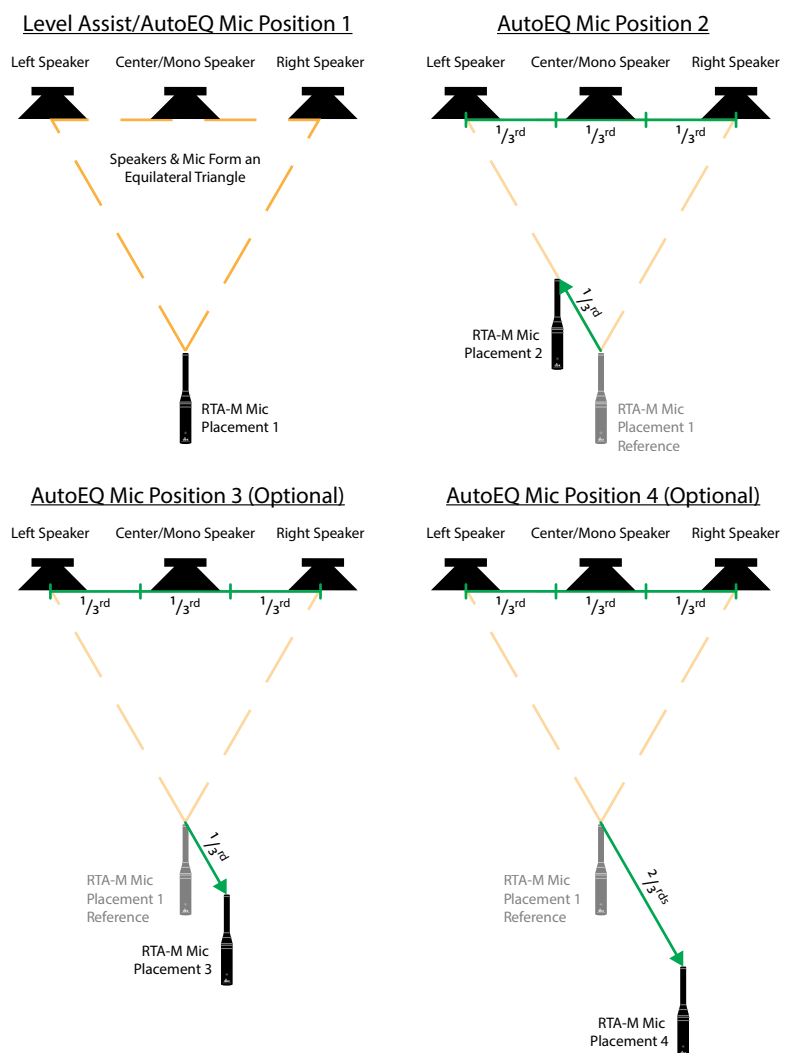

For example, if your speakers were 20 feet apart, you would move the microphone approximately 7' ($20 * (1/3) = 6.6$) from the RTA-M Mic Placement 1 Reference for mic positions 2-3 and approximately 14' from the RTA-M Mic Placement 1 Reference for mic position 4. However, as a general rule of thumb and for the sake of simplicity, a distance of 5' should work well for PA systems in most venues (around 1-3' for stage monitors). If the recommended placement of the mic in positions 2-4 are not possible, just place the mic in a position that differs from the other measurement positions to achieve a more accurate averaged response.

When a live sound system's frequency response is flattened, it can sound a bit thin on the low-end. When running AutoEQ, you will be given an option to select the desired AutoEQ "TARGET CURVE". Select the RECOMMENDED PA CURVE option (this is the default setting) to allow AutoEQ to automatically boost the low-end and prevent it from sounding thin. Select the FLAT option if you do want the system to be tuned flat when running the AutoEQ Wizard. Select the REFLECTIVE ROOM option to automatically attenuate higher frequencies when operating a sound system in a room with excessive acoustic reflections.

Run AFS Wizard

This Wizard walks you through the process of ringing out the system to provide higher system gain before feedback. This is accomplished by pushing your system into feedback so AFS can detect the frequencies that are prone to feedback and notch them using Fixed filters. When the AFS Wizard is complete, it will automatically enable the Live filters, for automated protection during system use. To use the AFS Wizard, simply set up all the microphones, perform a sound check, set up a rough mix for all microphones which will be used during the performance, then follow the on-screen instructions.

Wizard Options

The available options in this menu are:

- **Level Assist Auto Trim** [ON, OFF]

When this option is turned on, Level Assist will automatically make fine level adjustments under the hood for any system level mismatches which are 3 dB or less. When this option is turned off, no automatic level adjustments will be made by Level Assist and all system level mismatches will need to be adjusted using the amplifier attenuators until they are within a 1 dB tolerance.

NOTE: Level adjustments made by the LEVEL ASSIST AUTO TRIM function cannot be seen or edited. To clear them you must turn the LEVEL ASSIST AUTO TRIM function off then re-run Level Assist in the Wizard menu.

- **Mic Response** [dbx RTA-M, FLAT]

When the dbx RTA-M option is selected, AutoEQ will automatically compensate for the frequency response of the dbx RTA-M microphone, providing more accurate AutoEQ results. Select the FLAT option if using a measurement microphone other than the dbx RTA-M.

- **Setup Auto Preset Naming** [ON, OFF]

When this option is on, the VENU360 will automatically name presets based on the speaker selections made in the Setup Wizard. Note that the automatically generated preset name can still be edited when storing the preset if desired.

Configuring Inputs, Master Clock Source, & SRC

The VENU360 allows you to select either the internal crystal oscillator or one of the AES inputs for clock master. When using the VENU360-B/VENU360-D models and connecting to a BLU link ring or Dante network, master clock must be derived from the BLU link ring or Dante network, or from the internal BLU link/Dante card respectively.

Built-in sample rate conversion (SRC) can be used when connecting two different digital devices to the AES inputs (each with its own clock), when connecting digital AES signals operating at sample rates other than 48 or 96 kHz, or when using a combination of BLU link/Dante and AES input signals.

When running the Setup Wizard, the VENU360 will automatically configure the XLR inputs and master clock source for the application. And when using the VENU360-B/VENU360-D models, the Wizards will help walk you through the BLU link/Dante configuration – note that much of the Dante configuration will need to be performed in Audinate’s Dante Controller software. In most cases, even in complex configurations, the Wizards will make input assignments and clocking setup very easy. Some more-advanced configurations may require manual adjustments to these input configuration and clock settings, which can be performed in the Utility menu. For information on the Utility menu parameters, see **‘Utility Menu’ on page 92**.

The following section shows different clocking configurations and how the VENU360 should be configured for each.

All Analog Connections

When using all analog connections, select either the “Internal 48 kHz” or “Internal 96 kHz” clock source setting. In this configuration, XLR 1 and 2 must be configured for analog operation (these are the default settings from the factory).

VENU360 Utility Settings:

- Clock Source: Internal 48 kHz or 96 kHz
- XLR 1 Input Format: Analog 1
- SRC: N/A
- XLR 2 Input Format: Analog 2
- SRC: N/A

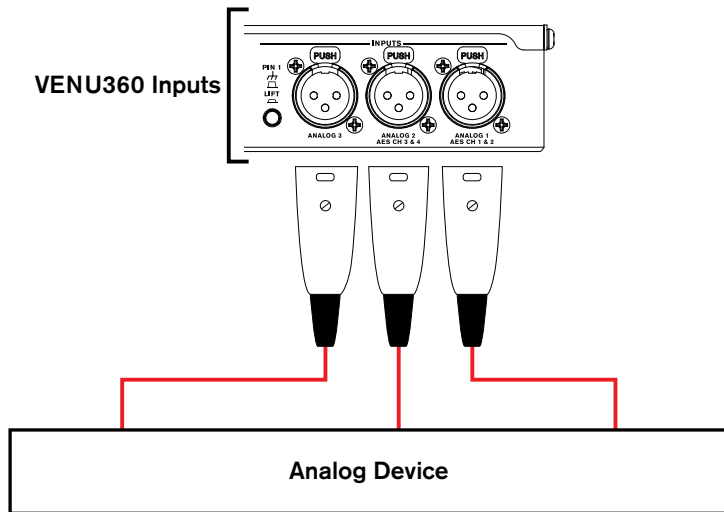

AES Connections From Single Device (48 or 96 kHz)

When both AES connections are made from the same digital device running at a 48 or 96 kHz sample rate, such as a digital mixer, you can clock from either AES input and turn SRC off for both inputs. In this configuration, XLR 1 and 2 must be configured for AES operation. Note that this configuration will also work when using two different digital devices which are clocked to the same clock (for example, using word clock).

VENU360 Utility Settings:

Clock Source: AES 1&2 or AES 3&4
 XLR 1 Input Format: AES 1&2
 SRC: OFF
 XLR 2 Input Format: AES 3&4
 SRC: OFF

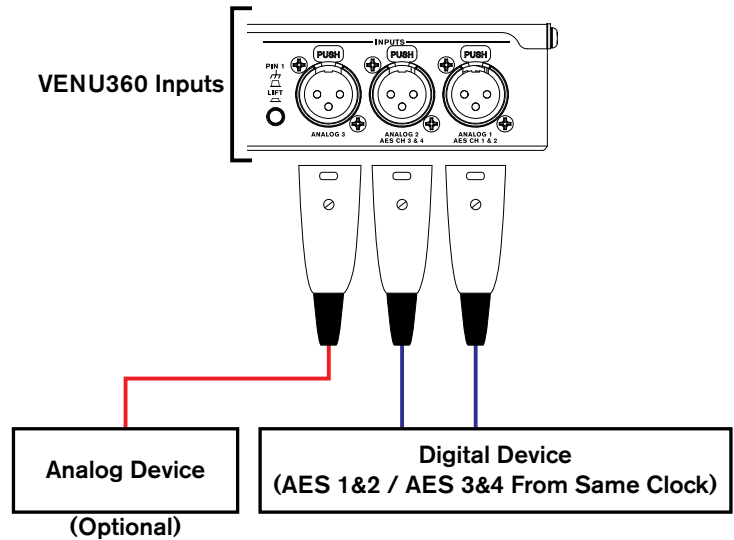

AES Connections Using Sample Rate Other Than 48 or 96 kHz

When connecting digital AES sources operating at sample rates other than 48 or 96 kHz, SRC can be used to allow such devices to be used with the VENU360. In this type of application, you must set the VENU360's clock source to one of the "Internal" options. SRC will automatically be enabled, allowing the digital signal to be sample rate converted to the internal clock frequency.

VENU360 Utility Settings:

Clock Source: Internal 48 kHz or 96 kHz
 XLR 1 Input Format: AES 1&2
 SRC: ON
 XLR 2 Input Format: AES 3&4
 SRC: ON

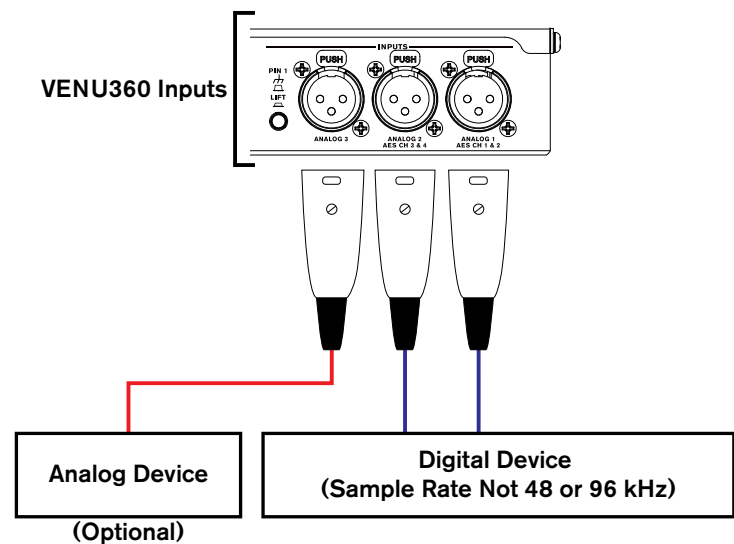

NOTE: The VENU360 supports sample rates of 48 or 96 kHz. The AES inputs cannot sync to a clock at any sample rate other than 48 or 96 kHz and sample rate conversion must be used with devices operating at other sample rates. When SRC is enabled, the VENU360 supports AES sample rates from 32-192 kHz.

NOTE: SRC is automatically enabled and the parameters become locked whenever one of the "Internal", "BLU link", or "Dante" clock options are selected. Therefore, SRC can only be disabled when one of the AES inputs is configured for clock master. This is a safety feature that prevents improper clock source settings when using the AES inputs.

AES Connections From Two Different Devices With Independent Clocks

When two different digital devices are connected to the AES input jacks, you will need to select one to clock to and enable SRC for the other. In this configuration, XLR 1 and 2 must be configured for AES operation.

VENU360 Utility Settings:

Clock Source: AES 1&2
 XLR 1 Input Format: AES 1&2
 SRC: OFF
 XLR 2 Input Format: AES 3&4
 SRC: ON

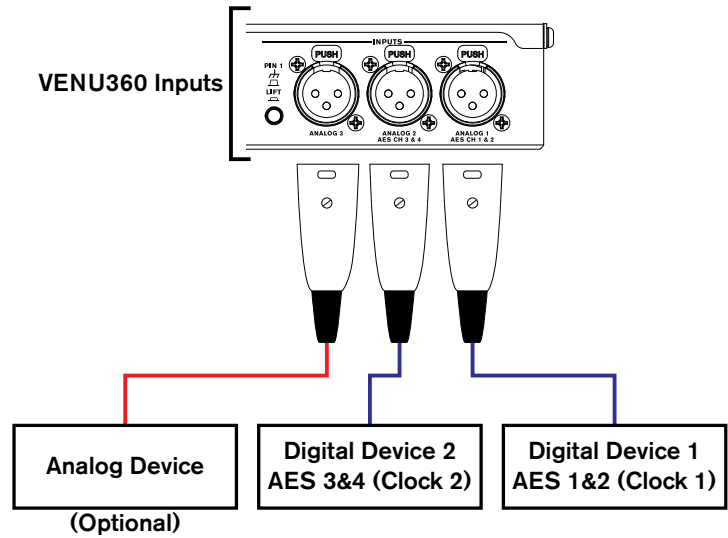

BLU Link Connections (VENU360-B)

When connecting a VENU360-B to other BLU link devices, one of the devices on the ring must provide master clock for all other connected devices. This is accomplished using priorities. Each connected BLU link device is given a "priority". The BLU link protocol auto-negotiates with all connected devices to determine which device has the highest priority and the device that wins becomes the master clock for the BLU link ring. In the VENU360-B, the BLU link Priority setting can be set in Utility > BLU link > BLU link Setup. By default, the VENU360-B's Priority setting is set low to allow another device, such as a mixer, to be the BLU link clock master.

VENU360-B Utility Settings:

Clock Source: BLU link
 BLU link Sample Rate: Set to match the sample rate of all other connected BLU link devices.
 BLU link Priority: Set higher than other BLU link devices to make the VENU360-B master. Set lower than another BLU link device to allow the other device to be clock master.

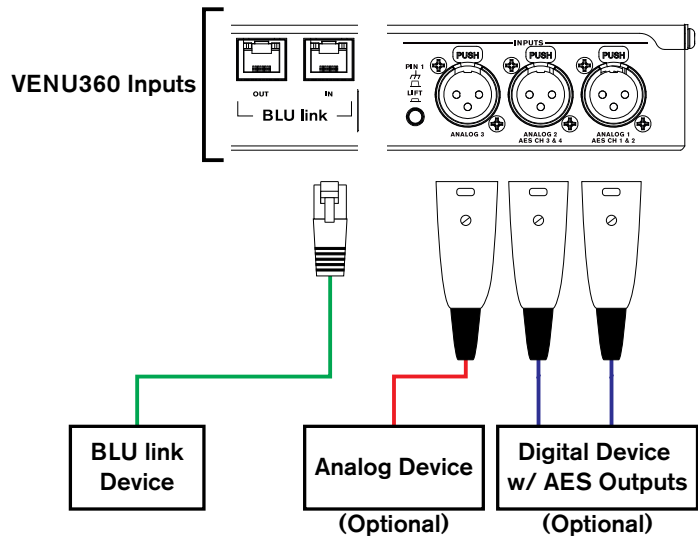

NOTE: In order for BLU link audio to pass through the VENU360-B, the VENU360-B's Clock Source setting must be set to "BLU link". When this setting is selected, SRC will automatically be enabled on the AES inputs, allowing the AES and analog inputs to be used alongside BLU link inputs if required for the application.

Dante Connections (VENU360-D)

When connecting a VENU360-D to other Dante devices, one of the devices on the network must provide master clock for all other connected devices. All configuration settings for the Dante network, including master clock device designation, must be configured using Audinate's Dante Controller software, available for free on Audinate's website. The only exception is the Clock Source setting, which must be configured in the VENU360-D as shown below.

VENU360-D Utility Settings:

Clock Source: Dante

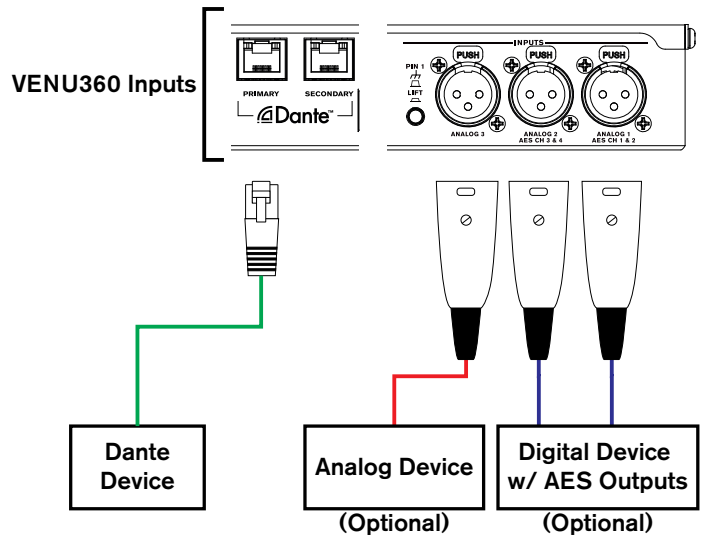

NOTE: In order for Dante audio to pass through the VENU360-D, the VENU360-D's Clock Source setting must be set to "Dante". When this setting is selected, SRC will automatically be enabled on the AES inputs, allowing the AES and analog inputs to be used alongside Dante inputs if required for the application.

Using Configuration Mode

This section describes how to make manual configuration changes to modify a preset for your application. The easiest way to configure the VENU360 is to use the built-in Wizards. This works well for configuring most systems utilizing full range up to mono 4-way crossover configurations (3-way main speakers with subs), as well as for configuring stage monitors. It also works well for initially configuring the VENU360 for delay fill and zone applications. However, some applications will require further “tweaking” of the configuration in Configuration mode, where you can:

- Edit input channel assignments (VENU360-B and VENU360-D models only)
- Configure signal routing and mixing for input and output processing chains
- Edit processing module insert types
- Link/unlink processing modules
- Configure crossover types
- Edit output names

It is also possible to create an entire configuration from scratch in Configuration mode. For example, you can load any existing or empty preset then edit the configuration from there.

To use Configuration mode:

| | |
|--|--|
| <p>1. Press the CONFIG button.</p> | |
| <p>2. Select a module using the SELECT wheel and UP/DOWN buttons.</p> | |
| <p>3. Press the SELECT wheel to change the configuration of the selected module. Repeat to make configuration changes to any other modules.</p> | |
| <p>4. When done, press the CONFIG button. A confirmation prompt will appear. See TIP following this table.</p> | |

5. Press the **CONFIG** button again or the **SELECT** wheel to apply the changes.

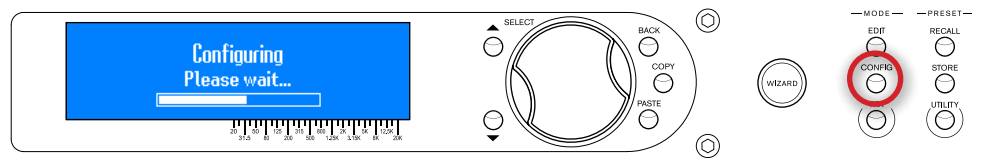

TIP: When done making configuration changes, pressing the **CONFIG** button twice will perform the “Quick Apply” function, for slightly faster operation.

NOTE: The VENU360 will load the new configuration and automatically mute all outputs – this is a safety feature. When ready to audition the system, unmute the outputs.

NOTE: The VENU360 can intelligently determine which modules have been modified in the configuration and make the necessary changes without losing the settings in all other “untouched” modules in the configuration.

Configuring BLU Link / Dante Inputs

When using the standard VENU360 model, input configuration is fixed with the following assignments: IN1: Analog1, IN2: Analog2, IN3: Analog3, IN4: AES1, IN5: AES2, IN6: AES3, and IN7: AES4. In the VENU360-B and VENU360-D models, inputs are configurable, allowing for the selection of the additional BLU link or Dante input channels. A combination of the analog, AES, and BLU link/Dante channels can be selected. The selected 7 inputs can then be mixed or routed to any available Router or Mixer module in the preset's signal chain.

IMPORTANT NOTE: When using the VENU360-B model, BLU link channel assignments must be made in the Utility > BLU link submenu or by running the BLU link Setup Wizard. These are the actual BLU link channels assigned to the VENU360-B and are configured separate of presets. This allows VENU360-B BLU link channel assignments to be edited at any time without breaking BLU link routing in all the presets. See **'BLU LINK' on page 92** for information on manually editing BLU link channel assignment settings. See **'Using The Wizards (Wizard Mode)' on page 17** for information on the BLU link Setup Wizard.

When using the VENU360-D model, Dante input channel assignments to the VENU360-D are made using Audinate's Dante Controller software.

To configure BLU link or Dante input channels:

1. Press the CONFIG button.

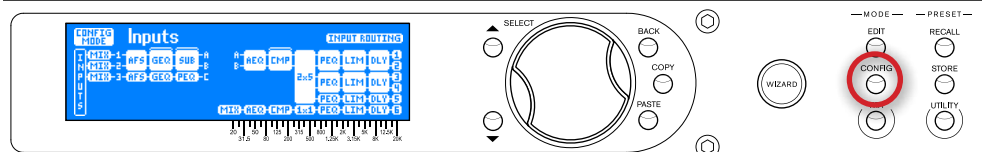

2. If it's not already selected, select the INPUTS module by turning the SELECT wheel.

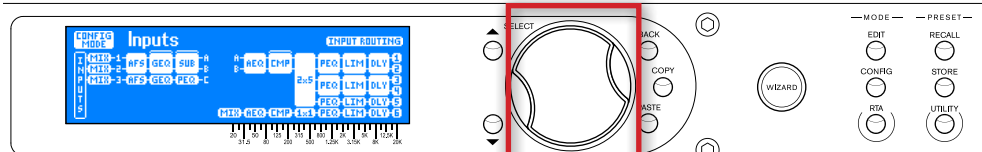

3. Press the SELECT wheel to enter the Input Configuration menu.

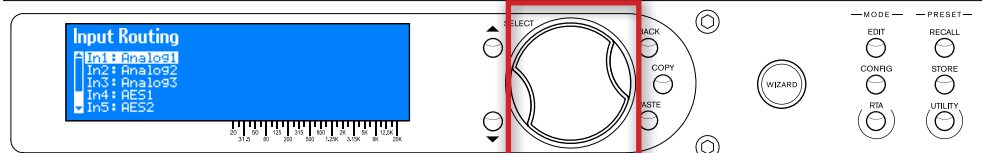

4. Select the input you wish to edit by turning then pressing the SELECT wheel.

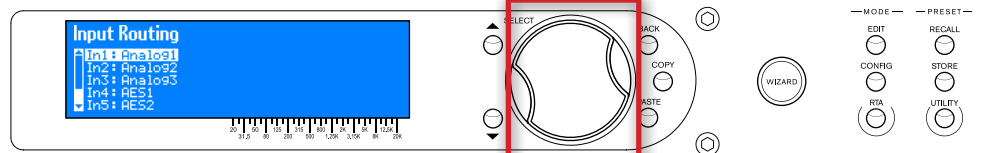

5. Select the desired option by turning then pressing the SELECT wheel.

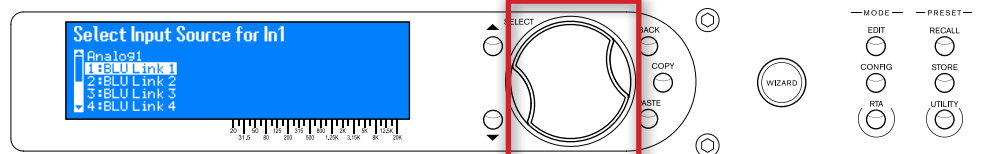

6. Repeat steps 4-5 to edit any additional input channel assignments.

7. When done, press the CONFIG button 3 times to apply the changes.

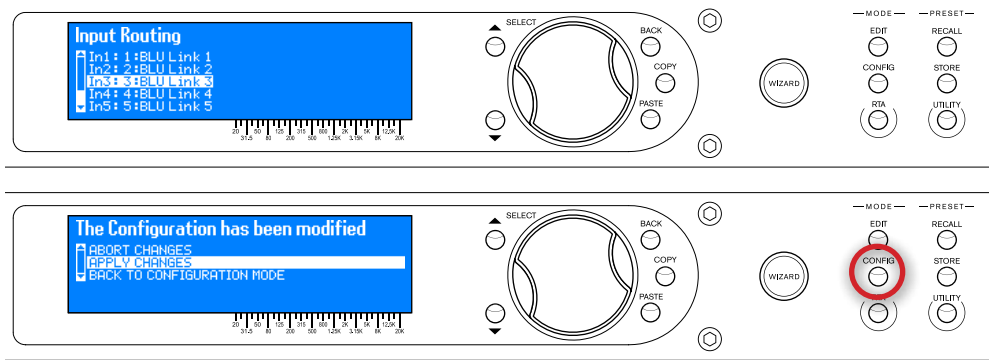

Configuring Mixers/Routers

Input signals in the VENU360 can be mixed or routed to the input processing chains or directly to the output processing chains. On the input processing chains, signals can be mixed or routed from any of the 7 direct inputs (e.g., Analog 1, Analog 2, AES1, BLU link channel 1, Dante channel 1, etc.). On the output processing chains, signals can also be mixed or routed from any of the 7 direct inputs, as well as the 1/2/3 bus points or A/B/C bus points – including summable variations of the 1/2/3 and A/B/C bus points. The 1/2/3 bus points allow signals to be routed to outputs pre any input processing. The A/B/C bus points allow routing to any outputs post input processing. The below diagrams show all the aforementioned routing/mixing options available to the input and mid (output) processing chains.

| Input Mixer/Router Chain Options | |
|----------------------------------|-----------------|
| Description | Routing Diagram |
| Route IN1 (*Analog 1) | |
| Route IN2 (*Analog 2) | |
| Route IN3 (*Analog 3) | |
| Route IN4 (*AES 1) | |
| Route IN5 (*AES 2) | |
| Route IN6 (*AES 3) | |
| Route IN7 (*AES 4) | |
| Mix Inputs | |

| Mid (Output) Mixer/Router Chain Options | |
|---|-----------------|
| Description | Routing Diagram |
| Route IN1 (*Analog 1) | |
| Route IN2 (*Analog 2) | |
| Route IN3 (*Analog 3) | |
| Route IN4 (*AES 1) | |
| Route IN5 (*AES 2) | |
| Route IN6 (*AES 3) | |
| Route IN7 (*AES 4) | |
| Mix Inputs | |
| Route 1 | |
| Route 2 | |
| Route 3 | |

| Mid (Output) Mixer/Router Chain Options | |
|---|-----------------|
| Description | Routing Diagram |
| Route 1+2 | |
| Route 2+3 | |
| Route 1+2+3 | |
| Mix 1, 2, 3 | |
| Route A | |
| Route B | |
| Route C | |
| Route A+B | |
| Route B+C | |
| Route A+B+C | |
| Mix A, B, C | |

*Fixed input channel configuration in standard VENU360 model. When using a VENU360-D (Dante) or VENU360-B (BLU link) model, input channel configuration can be modified to include Dante or BLU link channels depending on model. See **'Configuring BLU Link / Dante Inputs'** on page 26 for information on configuring input channels.

NOTE: When selecting one of the summed routing or mixing options on the previous page (e.g., Route 1+2, Route A+B, Input Mixer etc.) the summation of the signals will increase the signal level slightly. Therefore, each Router/Mixer module provides a master gain control which allows you to compensate for this by turning down the master signal level.

To configure a Mixer/Router:

1. Press the CONFIG button.
2. Select a Mixer/Router module using the SELECT wheel and UP/DOWN buttons.
3. Press the SELECT wheel to enter the Mixer/Router Configuration menu.
4. Select the desired option by turning then pressing the SELECT wheel.
5. Repeat steps 2-4 to configure any additional Router/Mixer modules.
See TIP following table for information on copying/pasting Router/Mixer module types.
6. Press the CONFIG button twice to apply the changes.

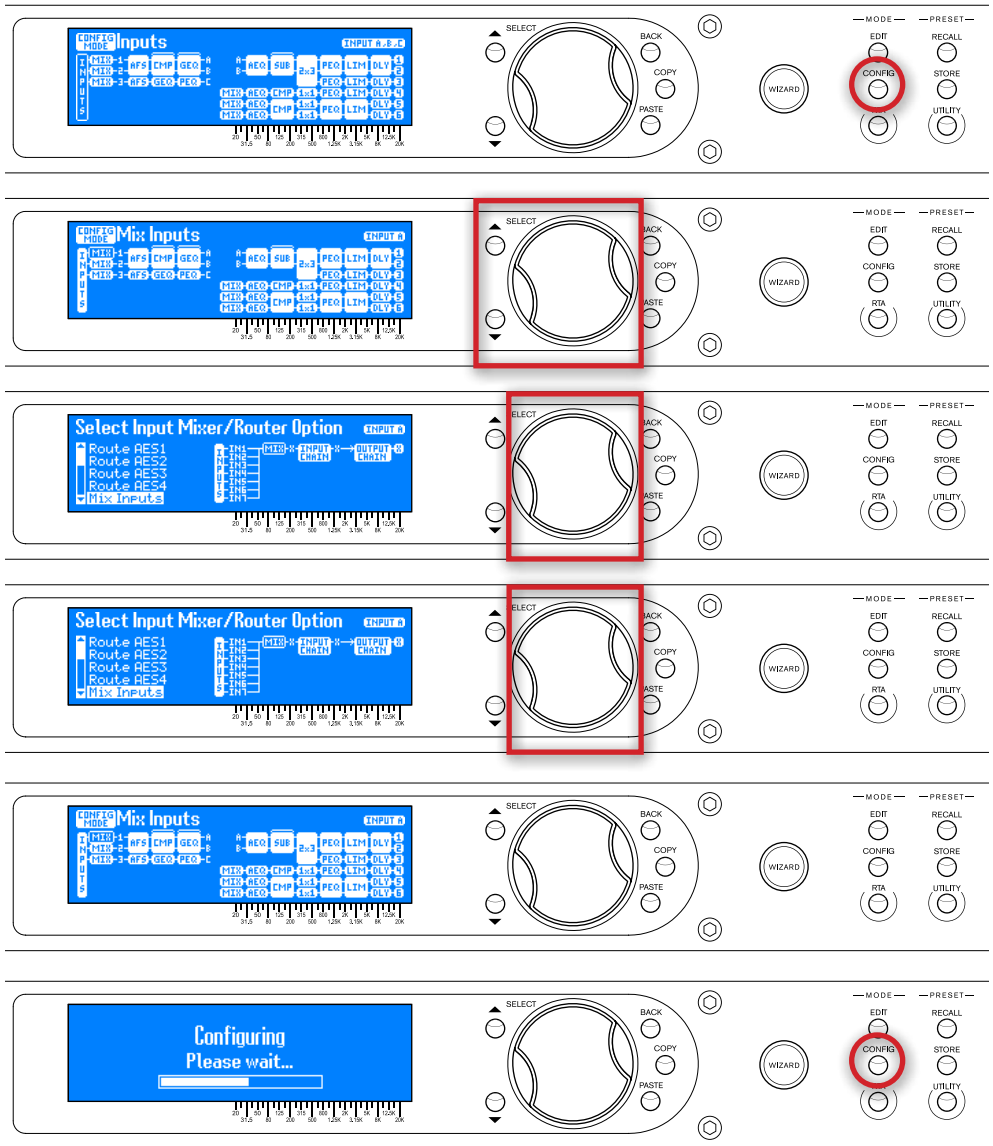

TIP: When multiple Mixers/Routers of the same type need to be configured, the **COPY/PASTE** buttons can be used to copy one Mixer/Router type and paste it to another Mixer/Router location, rather than entering the Mixer/Router Selection menu for each one. "Input" Mixer/Router types can be copied and pasted to other "Input" Mixer/Router locations. "Mid" Mixer/Router types can be copied and pasted to other "Mid" Mixer/Router locations. This provides a much more efficient way to configure multiple Mixer/Router modules as the same type.

Configuring Processing Module Insert Types

Processing module inserts are indicated in the on-screen configuration map by brackets at the top of their columns, as shown to the right. There are two configurable insert slots in the “input” processing chains and one configurable insert slot in the “mid” (output) processing chains.



Processing Module Inserts

The two input processing insert slots allow the following processing module insert types to be configured:

- Automatic Gain Control
- Backline Delay
- Compressor
- Graphic EQ
- Noise Gate
- Parametric EQ (12-Band with Narrow Notch Capabilities)
- Subharmonic Synth

NOTE: Processing modules of the same type cannot be inserted back-to-back in the input insert slots.

The mid processing insert slot allows the following processing module insert types to be configured:

- Automatic Gain Control
- Compressor
- Fill Delay
- Noise Gate
- Subharmonic Synth

To configure insert module types:

| | |
|---|--|
| <p>1. Press the CONFIG button.</p> | |
| <p>2. Select an insert module using the SELECT wheel and UP/DOWN buttons.</p> | |
| <p>3. Press SELECT then select the "Edit Module Insert Type" option with the SELECT wheel.</p> | |
| <p>4. Select the desired option by turning then pressing the SELECT wheel.</p> | |
| <p>5. Repeat steps 2-4 to configure any additional insert modules. See TIP following table for information on copying/pasting insert module types.</p> | |
| <p>6. When done, press the CONFIG button twice to apply the changes.</p> | |

TIP: Insert types can also be copied and pasted using the **COPY/PASTE** buttons, rather than entering the Insert Type Selection menu for each one. Simply select an inserted module and press the **COPY** button. Now select the desired insert slot destination and press the **PASTE** button. This provides a much more efficient way to configure multiple insert slots as the same module type.

Configuring Crossover Types

Crossover types can be selected in Configuration mode.

To configure Crossover module types:

1. Press the CONFIG button.

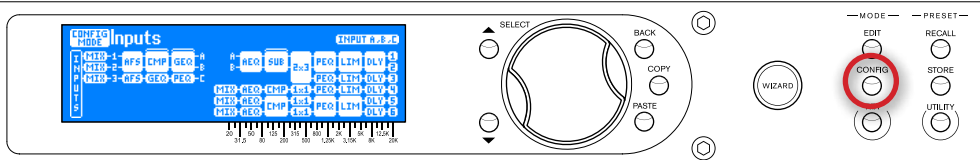

2. Select a Crossover module using the SELECT wheel and UP/DOWN buttons. Press the SELECT wheel to enter the Crossover Type Selection menu.

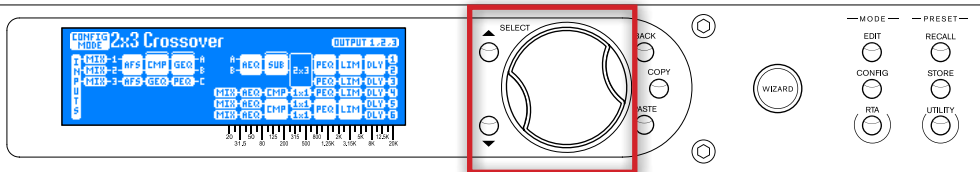

3. Select the desired option by turning then pressing the SELECT wheel. See TIP following table.

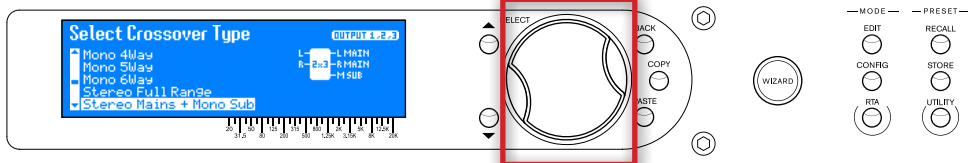

4. Repeat steps 2-3 to configure any additional Crossover modules.

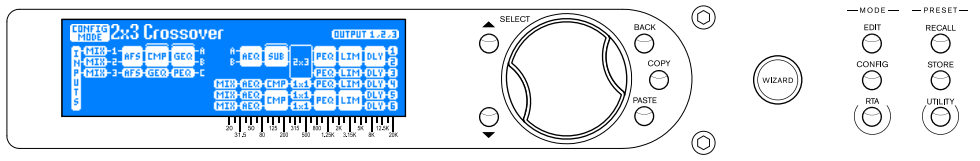

5. When done, press the CONFIG button twice to apply the changes.

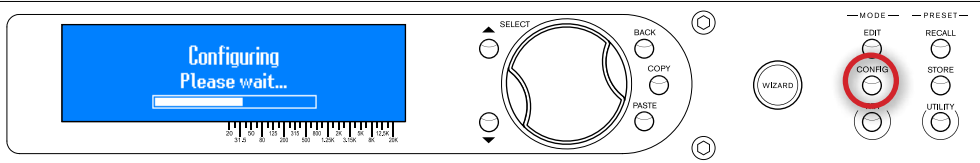



TIP: Outputs are automatically named when changing crossover configuration types. These output names can be edited if desired, see **'Naming Outputs' on page 42** for more information.

NOTE: When changing crossover configuration types, default crossover settings will automatically be set to get you started.

There are a total of 52 crossover types to select from. They are categorized by input configuration (i.e., mono, stereo, and LCR). Each input configuration type has various output configuration types (e.g., full range, multi-way, multi-mono, aux-fed subwoofers, etc.). The following table shows all the crossover configuration types available in the VENU360.

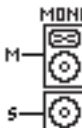
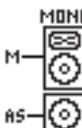
Crossover Types

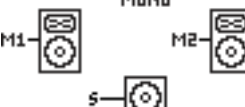
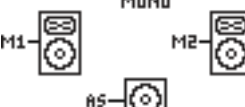
| Ref # | # Of Inputs/Outputs | Crossover Name | Crossover Configuration Icon | Supported Speaker Configuration |
|-------|---------------------|--------------------------|---------------------------------------|---|
| 1 | 1x1 | Mono Full Range | M-1x1-M FULL RANGE |  |
| 2 | 1x2 | Mono Main + Mono Sub | M-1x2-M MAIN -M SUB |  |
| 3 | 2x2 | Mono Main + Aux Sub | M-2x2-M MAIN A- A SUB |  |
| 4 | 1x2 | Mono Mains x2 | M-1x2-M MAIN1 -M MAIN2 |  |
| 5 | 1x3 | Mono Mains x2 + Mono Sub | M-1x3-M MAIN1 -M MAIN2 -M SUB |  |
| 6 | 2x3 | Mono Mains x2 + Aux Sub | M-2x3-M MAIN1 A- M MAIN2 -A SUB |  |

LEGEND: M=Mono, L=Left, C=Center, R=Right, A=Aux

LEGEND: FR=Full Range, S=Sub, AS=Aux Sub, H=High, M=Main or Mid, L=Low

Crossover Types

| Ref # | # Of Inputs/Outputs | Crossover Name | Crossover Configuration Icon | Supported Speaker Configuration |
|-------|---------------------|------------------------------|------------------------------|---------------------------------|
| 7 | 2x3 | Mono Mains x2 + Aux Sub | | |
| 8 | 1x4 | Mono Mains x2 + Mono Subs x2 | | |
| 9 | 2x4 | Mono Mains x2 + Aux Subs x2 | | |
| 10 | 1x3 | Mono Mains x3 | | |
| 11 | 1x4 | Mono Mains x3 + Mono Sub | | |
| 12 | 2x4 | Mono Mains x3 + Aux Sub | | |
| 13 | 1x5 | Mono Mains x3 + Mono Subs x2 | | |

LEGEND: M=Mono, L=Left, C=Center, R=Right, A=Aux

LEGEND: FR=Full Range, S=Sub, AS=Aux Sub, H=High, M=Main or Mid, L=Low

Crossover Types

| Ref # | # Of Inputs/Outputs | Crossover Name | Crossover Configuration Icon | Supported Speaker Configuration |
|-------|---------------------|------------------------------|------------------------------|---------------------------------|
| 14 | 2x5 | Mono Mains x3 + Aux Subs x2 | | |
| 15 | 1x6 | Mono Mains x3 + Mono Subs x3 | | |
| 16 | 2x6 | Mono Mains x3 + Aux Subs x3 | | |
| 17 | 1x2 | Mono 2Way | | |
| 18 | 1x3 | Mono 2Way + Mono Sub | | |
| 19 | 2x3 | Mono 2Way + Aux Sub | | |
| 20 | 1x4 | Mono 2Way x2 | | |

LEGEND: M=Mono, L=Left,
C=Center, R=Right, A=Aux

LEGEND: FR=Full Range, S=Sub,
AS=Aux Sub, H=High, M=Main or
Mid, L=Low

Crossover Types

| Ref # | # Of Inputs/Outputs | Crossover Name | Crossover Configuration Icon | Supported Speaker Configuration |
|-------|---------------------|-----------------------------|------------------------------|---------------------------------|
| 21 | 1x5 | Mono 2Way x2 + Mono Sub | | |
| 22 | 2x5 | Mono 2Way x2 + Aux Sub | | |
| 23 | 1x6 | Mono 2Way x2 + Mono Subs x2 | | |
| 24 | 2x6 | Mono 2Way x2 + Aux Subs x2 | | |
| 25 | 1x6 | Mono 2Way x3 | | |
| 26 | 1x3 | Mono 3Way | | |
| 27 | 1x4 | Mono 3Way + Mono Sub | | |

LEGEND: M=Mono, L=Left, C=Center, R=Right, A=Aux

LEGEND: FR=Full Range, S=Sub, AS=Aux Sub, H=High, M=Main or Mid, L=Low

Crossover Types

| Ref # | # Of Inputs/Outputs | Crossover Name | Crossover Configuration Icon | Supported Speaker Configuration |
|-------|---------------------|-------------------------|------------------------------|---------------------------------|
| 28 | 2x4 | Mono 3Way + Aux Sub | | |
| 29 | 1x6 | Mono 3Way x2 | | |
| 30 | 1x4 | Mono 4Way | | |
| 31 | 1x5 | Mono 5Way | | |
| 32 | 1x6 | Mono 6Way | | |
| 33 | 2x2 | Stereo Full Range | | |
| 34 | 2x3 | Stereo Mains + Mono Sub | | |

LEGEND: M=Mono, L=Left, C=Center, R=Right, A=Aux

LEGEND: FR=Full Range, S=Sub, AS=Aux Sub, H=High, M=Main or Mid, L=Low

Crossover Types

| Ref # | # Of Inputs/Outputs | Crossover Name | Crossover Configuration Icon | Supported Speaker Configuration |
|-------|---------------------|-----------------------------|------------------------------|---------------------------------|
| 35 | 3x3 | Stereo Mains + Aux Sub | | |
| 36 | 2x4 | Stereo Mains + Mono Subs x2 | | |
| 37 | 3x4 | Stereo Mains + Aux Subs x2 | | |
| 38 | 2x4 | Stereo Mains + Stereo Subs | | |
| 39 | 2x4 | Stereo 2Way | | |
| 40 | 2x5 | Stereo 2Way + Mono Sub | | |
| 41 | 3x5 | Stereo 2Way + Aux Sub | | |

LEGEND: M=Mono, L=Left, C=Center, R=Right, A=Aux

LEGEND: FR=Full Range, S=Sub, AS=Aux Sub, H=High, M=Main or Mid, L=Low

Crossover Types

| Ref # | # Of Inputs/Outputs | Crossover Name | Crossover Configuration Icon | Supported Speaker Configuration |
|-------|---------------------|----------------------------|------------------------------|---------------------------------|
| 42 | 2x6 | Stereo 2Way + Mono Subs x2 | | |
| 43 | 3x6 | Stereo 2Way + Aux Subs x2 | | |
| 44 | 2x6 | Stereo 2Way + Stereo Subs | | |
| 45 | 2x6 | Stereo 3Way | | |
| 46 | 3x3 | LCR Full Range | | |
| 47 | 3x4 | LCR Mains + Mono Sub | | |
| 48 | 3x5 | LCR Mains + Mono Subs x2 | | |

LEGEND: M=Mono, L=Left, C=Center, R=Right, A=Aux

LEGEND: FR=Full Range, S=Sub, AS=Aux Sub, H=High, M=Main or Mid, L=Low

Crossover Types

| Ref # | # Of Inputs/Outputs | Crossover Name | Crossover Configuration Icon | Supported Speaker Configuration |
|-------|---------------------|--------------------------|------------------------------|---------------------------------|
| 49 | 3x6 | LCR Mains + Mono Subs x3 | | |
| 50 | 3x5 | LCR Mains + Stereo Subs | | |
| 51 | 3x6 | LCR Mains + LCR Subs | | |
| 52 | 3x6 | LCR 2Way | | |

LEGEND: M=Mono, L=Left, C=Center, R=Right, A=Aux

LEGEND: FR=Full Range, S=Sub, AS=Aux Sub, H=High, M=Main or Mid, L=Low

Linking/Unlinking Processing Modules

Processing modules can be linked and unlinked in Configuration mode to best suit the application. Most processing modules can be linked/unlinked in the configuration.

To link/unlink processing modules:

| | |
|--|--|
| <p>1. Press the CONFIG button.</p> | |
| <p>2. Turn the SELECT wheel and/or press the UP/DOWN buttons to navigate the on-screen configuration map and select the module you wish to link/unlink. See TIP following table.</p> | |
| <p>3. Press the SELECT wheel. You may receive the Option Selection menu. If you do, select the "Link/Unlink Modules" option using the SELECT wheel.</p> | |
| <p>4. Turn the SELECT wheel clockwise to link with lower processing modules. Turn the SELECT wheel counter-clockwise to unlink selected processing modules.</p> | |
| <p>5. Press the SELECT wheel to confirm and continue. Pressing the BACK button will cancel the change and return to the previous screen.</p> | |
| <p>6. Repeat steps 2-5 to link/unlink any additional modules.</p> | |
| <p>7. When done, press the CONFIG button twice to apply the changes.</p> | |

TIP: Modules can only be linked downwards, so select the upper-most module to link. Note that AutoEQ, Router, Mixer, Crossover, and Output modules cannot be linked. Only "like" modules can be linked. To quickly change a module type to be "like" the one above it, select the module above and press the **COPY** button. Now select the module below and press the **PASTE** button.

Naming Outputs

Outputs are automatically named based on selections made in the Setup Wizard or when selecting crossover types in Configuration mode. Because of this, Crossover modules should be configured first, before naming outputs. If it is determined that the default output names must be modified for an application, it is very easy to do so in Configuration mode. One way to do this is to simply select an output name from the built-in list. If you find the name you were looking for, great! You're done. If you chose an option that was close, you can then further edit it using the on-screen instructions. Or, if desired, a completely custom name can be entered. Names can also be copied and pasted from one output to another.

To name outputs:

1. Press the CONFIG button.

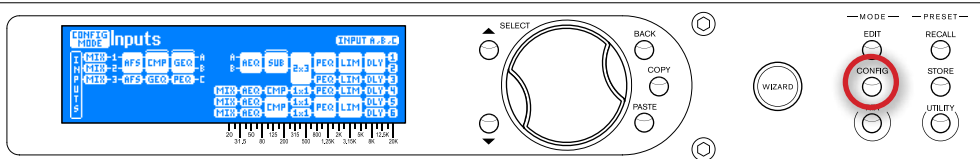

2. Use the SELECT wheel and UP/ DOWN buttons to navigate the on-screen configuration map and select the Output module you wish to rename. Press the SELECT wheel to confirm and continue.

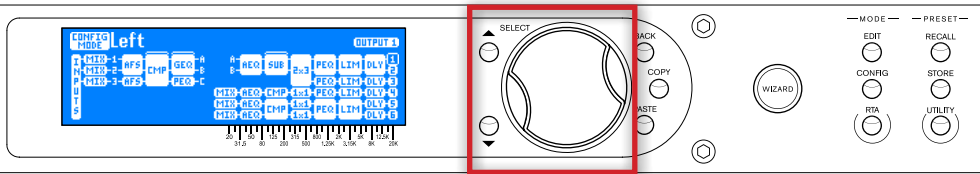

3. Follow the on-screen instructions to select from the name list and/or edit the name.

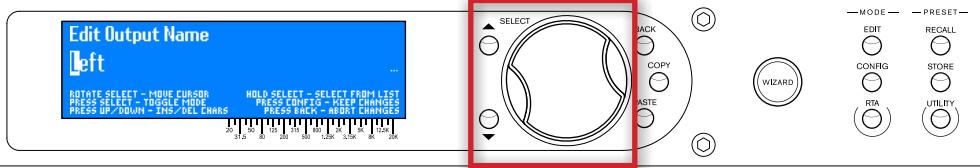

4. When done editing the name, press the CONFIG button to keep the changes and continue. Pressing the BACK button will abort the change and return to the previous screen.

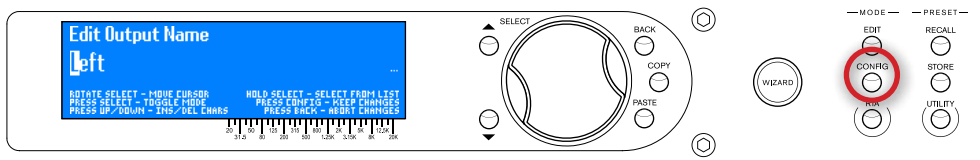

5. Repeat steps 2-4 to rename any additional Outputs. See TIP following table.

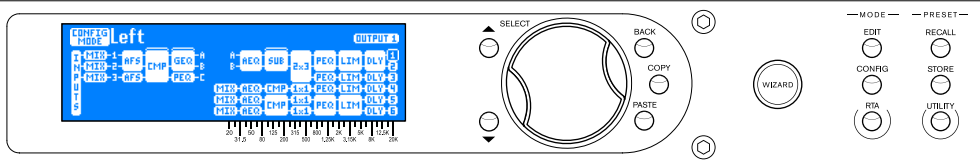

6. When done, press the CONFIG button twice to apply the changes.

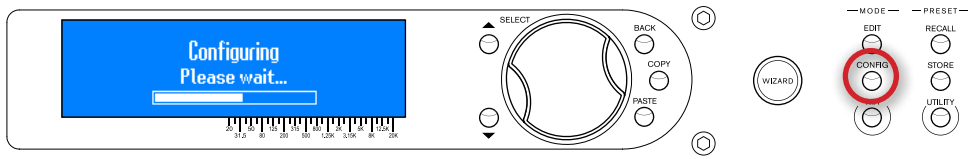

TIP: Output names can also be copied and pasted by selecting the Output modules and using the COPY/PASTE buttons. This provides a much more efficient way to name multiple outputs with similar names.

Operating The VENU360

This section of the manual describes how to edit VENU360 audio processing parameters and manage presets.

Editing Processing Module Parameters (Edit Mode)

To edit a processing module's parameters:

| | |
|---|--|
| <p>1. Press the EDIT button.</p> | |
| <p>2. Select the module you wish to edit using the SELECT wheel and UP/DOWN buttons.</p> | |
| <p>3. Press SELECT to enter the module's Edit menu. Use the SELECT wheel and UP/DOWN buttons to select and edit parameters and options. See TIP 1 and TIP 2 following table.</p> | |
| <p>4. When done editing, press the BACK button to exit the menu. Repeat steps 2 and 3 to edit additional modules.</p> | |
| <p>5. When done editing, press the BACK button repeatedly to return to the Home screen.</p> | |

TIP 1: The menu can be navigated using either the **UP/DOWN** buttons or by pressing the **SELECT** wheel to jump back and forth between columns for DriveRack PA2-style menu navigation.

TIP 2: Pressing and holding the **EDIT** button when in a module's Edit menu will automatically navigate to the next module down in the configuration map column, for fast in-menu navigation between like processing modules.

Copying/Pasting Processing Module Settings

In Edit mode, the COPY/PASTE buttons allow you to copy all parameters of a module and paste them to another like processing module. A like processing module is one that is of the same processing type and contains the same parameters as the processing module that was copied.

To copy/paste settings from one processing module to another:

1. Press the EDIT button.

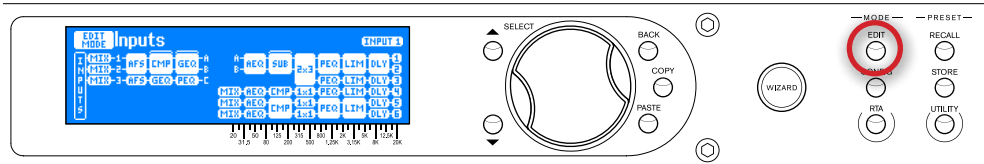

2. Select the module you wish to copy using the SELECT wheel and UP/DOWN buttons.

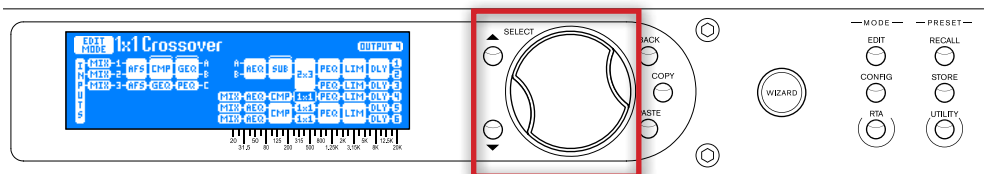

3. Press the COPY button.

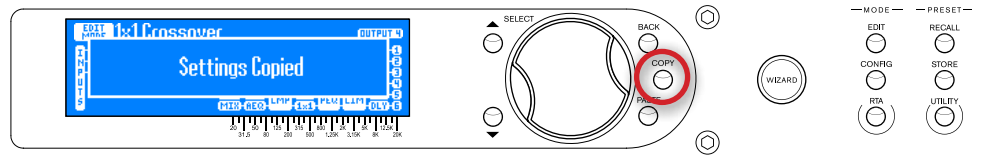

4. Select the like module you wish to paste the settings to using the SELECT wheel and UP/DOWN buttons.

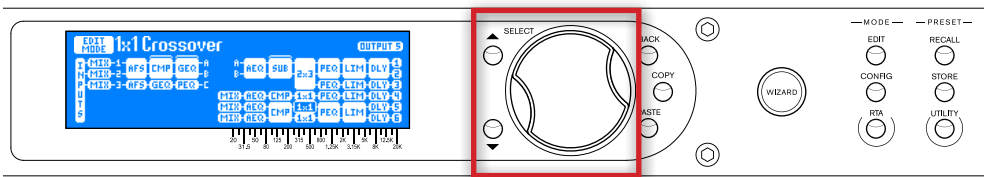

5. Press the PASTE button. Repeat steps 2-5 to copy/paste additional settings.

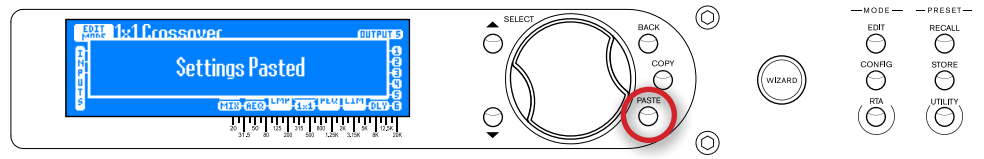

6. When done editing, press the BACK button repeatedly to return to the Home screen.

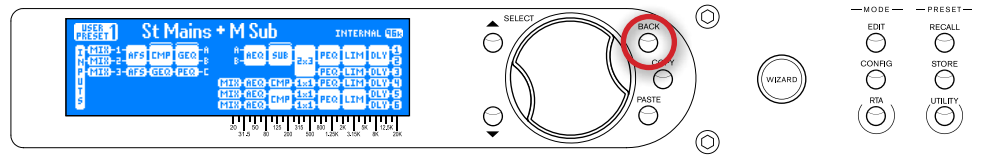

TIP: Processing module settings can also be copied and pasted between presets.

Managing Presets

The VENU360 has two types of presets: user and factory. The user presets occupy preset memory locations 1-75. The factory presets occupy preset memory locations 76-100. The difference between these preset types is that factory presets are meant to be used as templates and cannot be overwritten and user presets can be overwritten and are designed to store your custom presets.

You can load either a factory or user preset to start with, edit the preset, then store the changes to any one of the 75 user preset memory locations. All settings created when running the Wizards, modifications made in Configuration mode, and all settings located in the processing modules (e.g., GEO, Limiter, Delay, Crossover, etc.) will be stored to the preset. The exceptions are the Utility and RTA settings, which are global and are not stored to individual presets.

Recalling Presets

To recall a preset:

1. Press the RECALL button.

2. Select the preset you wish to recall using the SELECT wheel or UP/DOWN buttons.

3. Press the RECALL button or SELECT wheel to recall the selected preset.

The diagrams show the control panel with the following elements: a central SELECT wheel with up/down arrows, BACK, COPY, PASTE, and WIZARD buttons, and a PRESET menu with buttons for EDIT, RECALL, CONFIG, STORE, RTA, and UTILITY. The screen displays a list of presets under 'Recall Preset (User)'. In the third diagram, the screen shows the selected preset 'St Mains + M Sub' with various parameters like EQ, COMP, GEO, and LIM.

Storing Presets

Once you are satisfied with the changes made to a preset, you can store them to a user preset memory location.

To store a preset:

1. Press the STORE button.

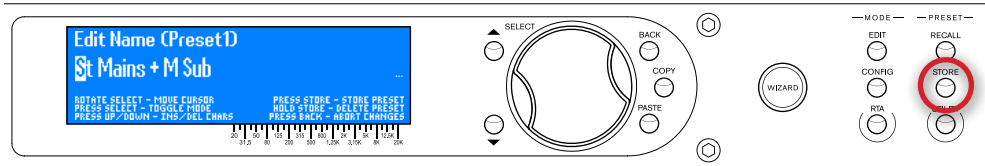

2. The current name of the preset will be shown in the LCD display and you now have the option to keep it or rename it. If you do not wish to rename the preset, proceed to step 3. If you do wish to rename the preset, follow the on-screen instructions.

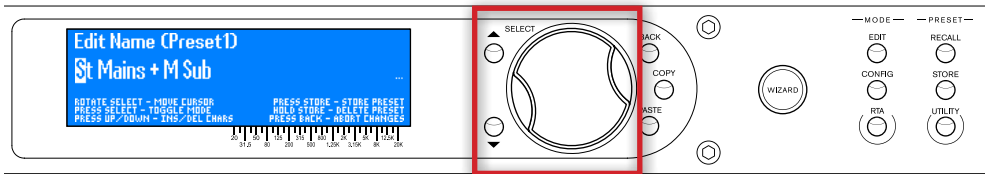

3. Press the STORE button a second time.

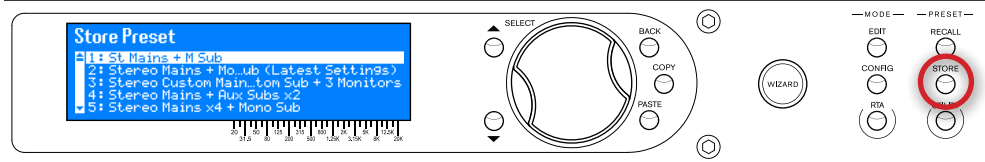

4. Turn the SELECT wheel to select the user preset memory location you wish to store the preset to. If you wish to store the preset to its current memory location, leave as is.

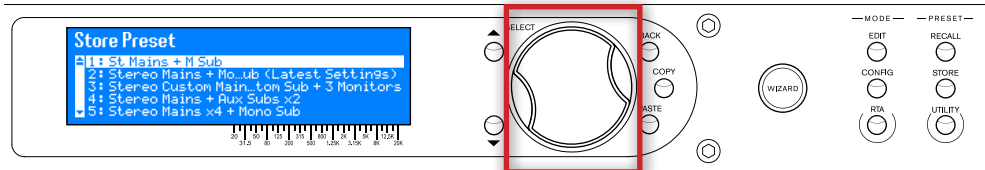

WARNING! The preset residing in the selected memory location will be overwritten.

5. Press the STORE button a third time or the SELECT wheel to store the preset.

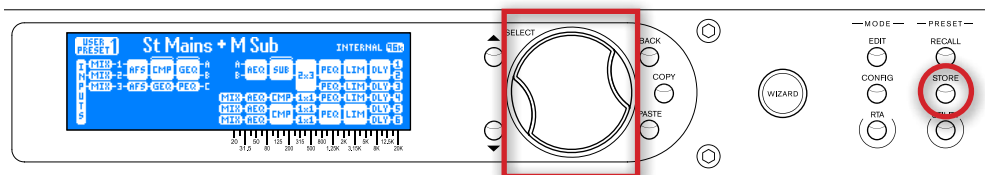

TIP: Pressing the STORE button three times in succession will perform a “Quick Store” function, allowing you to quickly update a preset after making changes. Performing this operation will store the updated settings to the current memory location with the current preset name.

NOTE: The STORE button will light whenever a preset’s settings have been modified from their stored value, indicating the changes need be stored to memory to be retained. Any unstored preset setting changes will be retained after a power cycle as long as the PRESET POWERUP option in the Utility menu is set to the default setting of “CURRENT”, see **‘Preset Powerup’** under **‘Utility Menu’** on page 92 for further information on this feature. Any modified and unstored settings will be lost if the unit is power cycled with the PRESET POWERUP option set to “STORED” or if another preset is recalled.

Copying Presets

Presets can be copied from one memory location to another. This can be useful for creating a backup of a preset within the VENU360 box, creating variations of similar presets, or for creating an initial preset template and then copying that preset template for use at each venue the system is used.

To copy a preset:

1. Recall the preset you wish to copy (see 'Recalling Presets' on page 45).
2. Press the STORE button.
3. The current name of the preset will be shown in the LCD display and you now have the option to keep it or rename it. If you do not wish to rename the preset, proceed to step 4. If you do wish to rename the preset, follow the on-screen instructions.
4. Press the STORE button a second time.
5. Turn the SELECT wheel to select the user preset memory location you wish to copy the preset to.
6. Press the STORE button a third time or the SELECT wheel to copy the preset to the new preset memory location. Note that the preset that was residing in the selected memory location will be permanently overwritten.

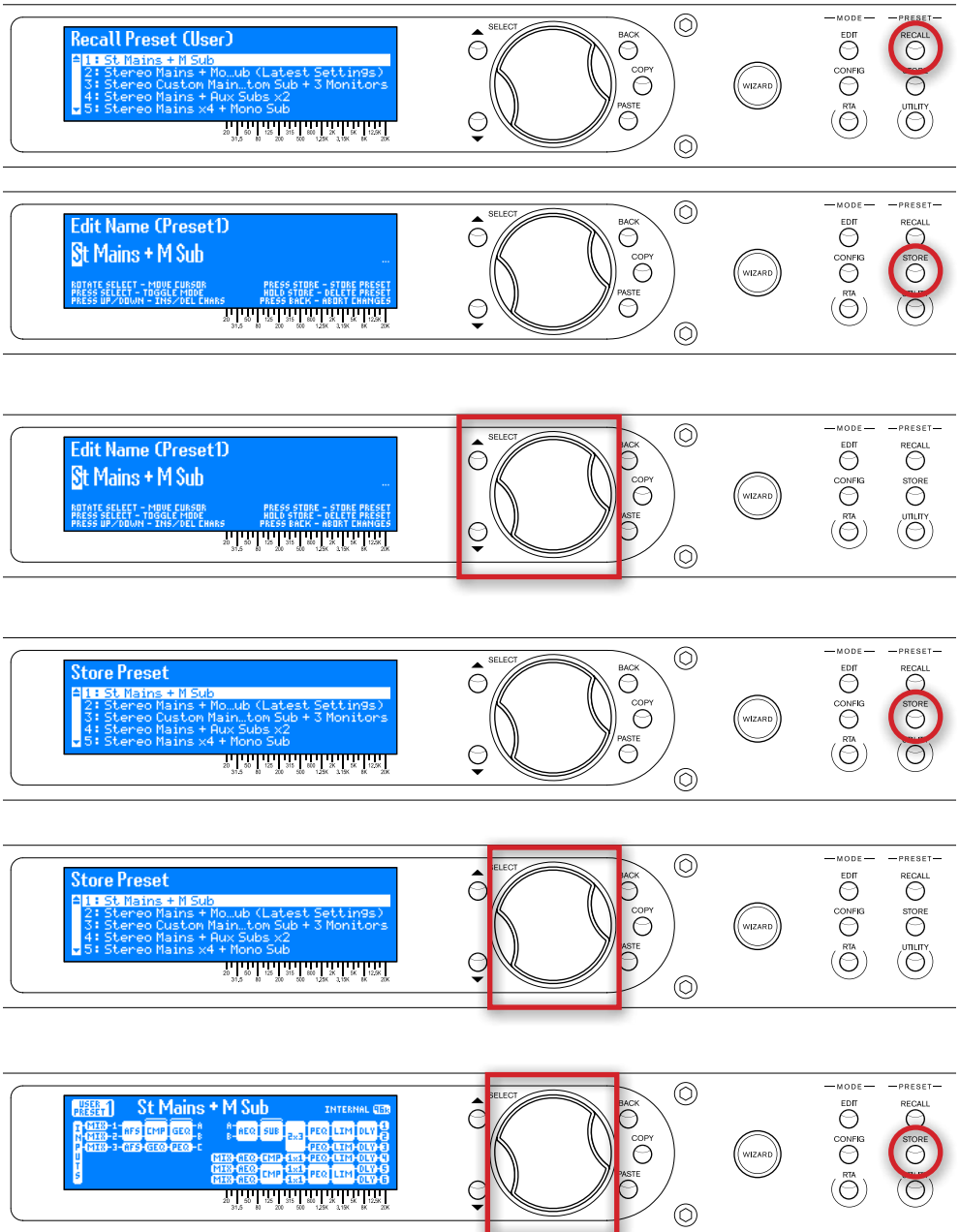

Deleting Presets

User presets can be deleted. Deleting a user preset creates an empty preset. When an empty preset is loaded, no signal will pass through the VENU360. A new configuration can be created in an empty preset by running the System Setup Wizard or pressing the **CONFIG** button.

To delete a preset:

1. Recall any preset that is not empty then press the **STORE** button. See **TIP** below table.

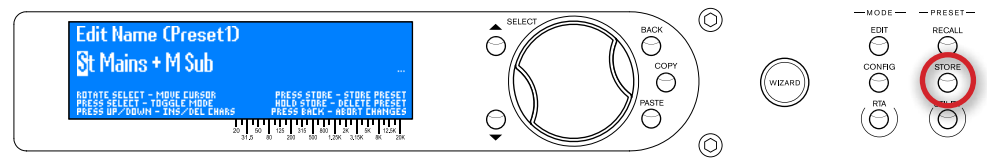

2. The current name of the preset will be shown in the LCD display. Press and hold the **STORE** button for ~2 seconds.

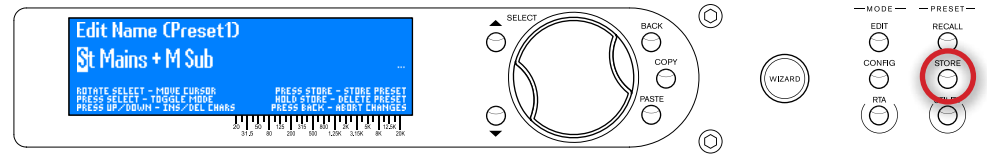

3. Use the **SELECT** wheel and/or **UP/DOWN** buttons to select the preset you wish to delete.

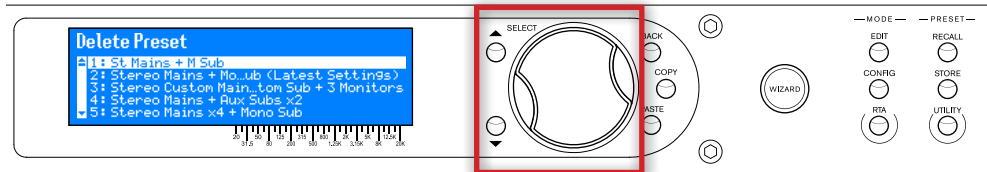

4. Press the **SELECT** wheel to delete the selected preset.

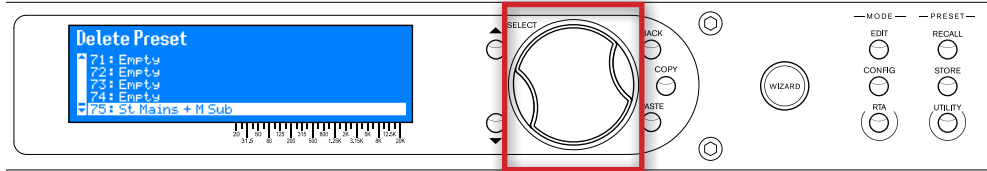

5. A confirmation screen will appear. Select the **“YES”** option using the **SELECT** wheel to confirm and delete the preset.

WARNING! The preset residing in the selected memory location will be permanently deleted.

Selecting the **“NO”** option will abort the procedure and return to the last screen.

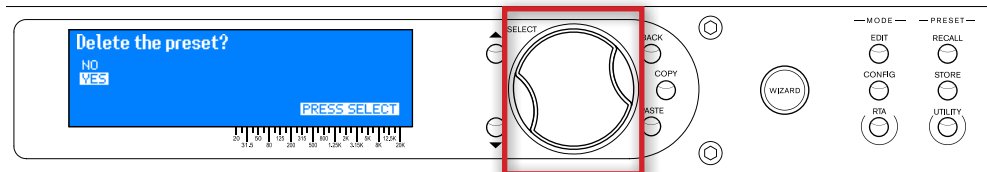

6. Repeat steps 3-5 to delete any additional presets.

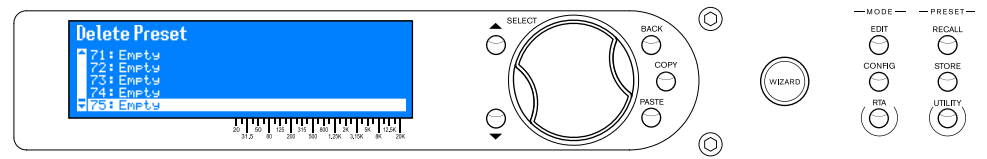

TIP: Pressing and holding the **STORE** button for ~2 seconds will take you straight to step 3.

Manually Optimizing A System Using The VENU360

About Speaker & Amplifier Tunings

The VENU360 has a Setup Wizard to help you configure your sound system. When you run the Setup Wizard, it will ask you to select the make and model of your speakers and amplifiers from a list of available options, referred to as “tunings”. There are speaker tunings and amplifier tunings. When you select your speakers from the tuning list, the VENU360 will automatically configure the crossover, output PEQs, polarity, and, in some cases, driver alignment delays. When you select your amplifiers from the tuning list, the VENU360 will automatically set the analog output clip levels (located in the Utility menu) and limiter settings.

The VENU360 includes a variety of speaker and amplifier tunings from JBL®, Crown®, and more. If your particular tunings are not available in the VENU360's preset tuning list, you can use the VENU360 control app to access the online database where you can find additional tunings. If you can't find tunings for your particular speakers or amplifiers, you will need to select the “Not Listed??” option in the list. The VENU360 will automatically set usable default settings which may sound and work just fine, however, you may wish to manually calibrate the VENU360 in order to realize the full potential of the sound system and ensure the loudspeakers are protected. Providing full details on how to manually calibrate a sound system is beyond the scope of this manual, but you can find books and free information on the Internet which cover these topics. This section of the manual will cover some of the basics to help get you started.

Loudspeaker manufacturers perform extensive testing on their products and will often provide some of the data necessary to optimize their loudspeakers. Check your speaker manufacturer's website or contact them directly to see if they can provide a speaker tuning data sheet that you can use for manually entering speaker tuning parameters into the VENU360. These tuning data sheets will typically include recommended crossover, polarity, driver alignment delay, and sometimes, parametric EQ settings.

Manual System Optimization Tips

TIP: You may want to disable the HOME TIME OUT feature located in the Utility menu before performing any of the following system optimization procedures. This will ensure the VENU360 does not revert back to the home screen throughout the process. See **'Home Screen Time Out'** under **'Utility Menu'** on page 92 for more information on disabling this feature.

1. Set Crossover Frequency & Filter Settings

The active crossover in the VENU360 is used to allow each speaker or driver in a multi-way loudspeaker systems to operate within its frequency range limits. If you can't find any tuning information for a particular speaker/driver, get the specification sheet for it from the manufacturer. It can give you a good idea where to set crossover frequency settings by providing the speaker or driver's frequency response, which is the range of frequencies each speaker or driver is capable of reproducing.

If you're bi-amping or tri-amping main speaker cabinets, the speaker manufacturer should be able to provide you with the recommended crossover frequency settings, and oftentimes, filter types and slope rates. If you're using subs and can't find recommended crossover frequency settings, you can dial it in by ear. Typically, subs and mains will be crossed over at around 80-100 Hz, so somewhere in this range is a good place to start. You can then fine-tune the settings from there by ear using full-bandwidth reference material that you are familiar with. When auditioning these crossover settings, it helps to first balance the amp levels for all drivers or cabinets to achieve a frequency response that suits your taste. When auditioning the sound system, don't turn it up too loud until you've calibrated the gain structure – more about this later.

If you're configuring a simple full-range system then you don't necessarily need to enter any crossover parameters. However, it is a good idea to take note of the speaker's frequency response spec and set a high-pass filter at the lower frequency limit specified (45 Hz, for example). This will prevent excessive driver excursion caused by subsonic frequencies and allow for more headroom in your amp. You'll then want to choose a filter type and slope rate that will effectively roll-off the low end without dramatically compromising the low-end response of the sound system (try auditioning BW 24-BW 48 filter types). Note that the VENU360 may automatically set a high-pass filter after configuration. This is a precautionary measure and these settings can easily be adjusted as just described. See **'Crossover Module'** on page 84 for information on editing the crossover.

Once the crossover frequencies have been set, it's time to set the filter types and slope rates. Determining which settings to use here can be a bit difficult. These settings are dependent on the natural frequency response and roll-off characteristics of each speaker cabinet or driver. The goal is to achieve a flat frequency response throughout the loudspeaker system with seamless transitions throughout the crossover overlap regions. For example, a midrange driver in a 3-way system may inherently exhibit a fairly gradual roll-off up into the high end, whereas the tweeter may require a steep roll-off to protect it from over-excursion. In this case, the midrange driver can be set with a more gradual roll-off to fill in the "gap" created from the steep roll-off of the tweeter. You can use a combination of the RTA and your ears to dial in these settings. Just make sure you don't exceed the frequency range limitations of the drivers. The difference between the LR and BW filter type options is in the way they sum together. You want to select the filter types that provide the flattest frequency response throughout the crossover overlap regions. Note that it's okay to mix and match these filter types if that's what it takes to achieve a flatter system response. Also note that you may not be able to achieve a flat response at this stage of the process due to driver alignment, polarity, and/or phase issues. Therefore, just get it as close as you can for now. For more information on LR and BW filters, see "LP TYPE" and "HP TYPE" under the section, **'Crossover Module'** on page 84.

2. Set Driver Alignment Delays, Polarity, & Phase

Once the crossover frequencies, filter types, and slope rates have been set, you're ready to optimize the system's phase response. All drivers in the system need to work in unison in order for the sound system to sound its best. This is accomplished by setting driver alignment delays to make up for any physical driver offsets, matching the polarity for all drivers, and adjusting the inter-band phase relationship (if applicable).

The VENU360's output POLARITY parameter (located in the crossover) is used to match polarity between drivers. Some multi-way main speakers will require certain drivers to be polarity inverted when operating in bi-amped or tri-amped mode. When selecting any bi-ampable or tri-ampable main speaker from the VENU360's speaker tuning list in the Setup Wizard, such polarity inversion will be performed for you automatically. If your multi-way main speaker model isn't listed in the VENU360 and you can't find tuning information for them, check the loudspeaker's spec sheet or documentation, or contact the speaker manufacturer as they will usually be able to provide this information.

If you're unable to find polarity information for your speakers, or just want to verify your drivers are in phase, you can do some investigative work using the VENU360's built-in signal generator. To do so, take note of the crossover frequency setting used between the drivers being tested then use the built-in signal generator (located in the RTA menu) to play a sine tone at this frequency through the two drivers.

TIP: Make sure any active AFS modules are turned off before engaging the signal tone generator. Failing to do so may cause Live AFS filters to be set.

For example, if you're testing the woofer and high frequency driver in a bi-amped main speaker cabinet and the active crossover frequency between the two is set at 2.5 kHz, adjust the signal generator to play a 2.5 kHz sine tone through the two drivers being tested. Stand in the "sweet spot" of the venue (the audience position equidistant from the speakers) and invert the polarity in the VENU360's crossover for the low output and find out which setting provides the loudest signal level (note that results are most noticeable if sound pressure levels between the drivers have been matched). The setting which provides the loudest signal level is the one which is more "in phase" and is the setting you should use. If applicable, perform this same test, working your way down through the lower-frequency drivers.

Once polarity is matched for all drivers in the system, you're ready to optimize the driver alignment delays. The "polarity" test mentioned in the previous paragraph can also be used for determining if driver alignment delay is necessary. Play the selected sine tone through the system (once again, the sine tone frequency should match the set crossover frequency of the drivers being tested) and invert the polarity on the lower driver so that the two drivers are out of phase. If necessary, adjust the drivers' levels until the most phase cancellation is achieved. Try adjusting the driver alignment delay for each driver to see if either produces more phase cancellation. Set the delay for the most phase cancellation on whichever driver requires it. When done, set the polarity back for proper phase alignment. Repeat this procedure for any remaining speakers/drivers if applicable. For more information on setting driver alignment delays, see **'Delay (DLY) Modules' on page 69**.

Variable phase adjustments can be made to each band using the PHASE parameters in the crossover. When using a band-pass filter, the high-pass filter can interact with the low-pass filter when in close proximity. This can cause phase shifts which can change the directionality (polar response) of the frequencies in the crossover overlap region. The PHASE parameter utilizes a single-pole all-pass filter to correct for this.

In the below graph, three measurements of a crossover band are plotted to illustrate how an all-pass filter (the VENU360 PHASE parameter) can be used to correct for the phase shift caused by the addition of a high-pass filter. Butterworth 6 dB/octave (BW 6) high-pass and low-pass filters were selected in order to illustrate the effects of the all-pass filter.

- 1. — Low-Pass:** A BW 6 low-pass filter causes a -45 degree phase shift at the low-pass filter frequency (200Hz).
- 2. — Band-Pass:** (a) Adding a BW 6 high-pass filter to the existing low-pass filter causes a +45 degree phase shift at the high-pass filter frequency (95Hz). (b) This causes the phase shift to increase at the low-pass frequency by +25 degrees (the amount of shift depends on the high-pass and low-pass filter types, as well as the proximity of the high-pass frequency to the low-pass frequency).
- 3. — Band-Pass With Phase Correction:** Setting the phase parameter to -25 degrees realigns the phase of the signal at the low-pass crossover point.

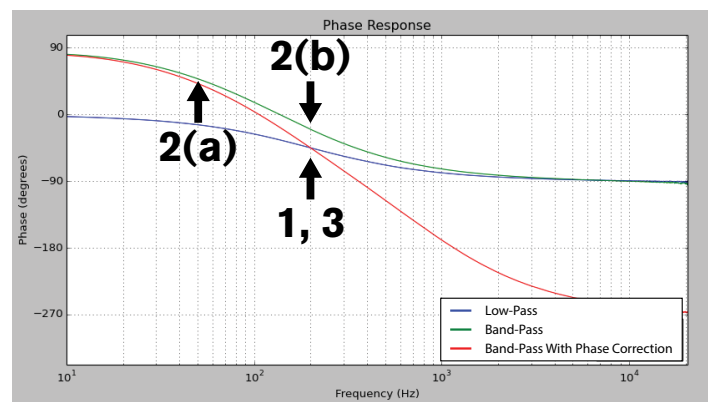

If the crossover is configured with bands using only a high-pass or low-pass filter (such as in the 2-way example shown below) you shouldn't have to worry about adjusting the PHASE parameter. However, if band-pass filters are used (such as in the 3-way example shown below) then phase adjustments will likely be necessary.

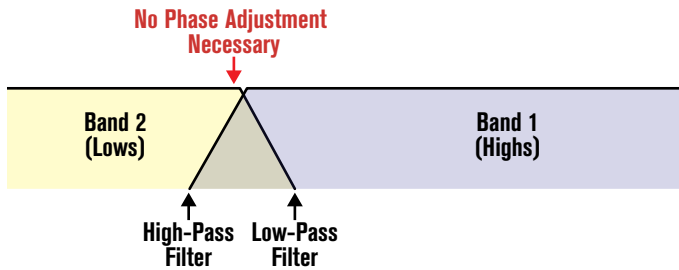

2-Way Phase Adjustment Example

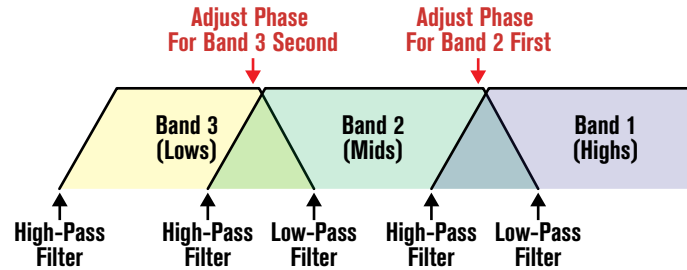

3-Way Phase Adjustment Example

To tune the PHASE parameter, use the same “polarity” test previously mentioned and start with the highest crossover frequency (the crossover frequency between bands 1 and 2 in the above 3-way example). Using this example, the sine tone would be set at 2.5 kHz, the polarity would be inverted on the mid band, then the PHASE parameter would be adjusted on the mid band for the most cancellation. When done, polarity would be set back to the correct setting. This same test would then be performed between the low and mid band by setting the sine tone to the low-to-mid crossover frequency, inverting the polarity on the low band, then adjusting the low band phase for the most cancellation. When done, polarity would be set back to the correct setting.

The crossover should now be optimized for use with the loudspeaker system. Listen to some reference music through the system to see how it's sounding. Changes to all these settings can be difficult to judge when heard in the context of the whole system, but by zeroing in on the specific crossover frequency regions, matching levels, and inverting polarity on one of the drivers, you are free to experiment with different settings to determine the best settings for your loudspeaker system. Adjust each of these parameters until the most phase cancellation is achieved then switch the polarity back so the drivers are once again in phase. Optimizing these parameters using this test will allow your system to work in harmony and improve its magnitude, phase, and polar response.

3. Set Gain Structure & Limiters

Now that the crossover settings are optimized and the loudspeaker drivers are in phase, it's time to calibrate the gain structure of the system. This will provide ample headroom for all system components in the signal chain and optimize the system's signal-to-noise performance.

Your amplifiers play a vital role in system setup because they are the last devices in the signal chain before your loudspeakers and offer the greatest amount of gain (that is their job after all). If your amplifiers are setup incorrectly you will not be using your system to its fullest potential and could potentially cause damage to your loudspeakers. When you select your amplifier models in the Setup Wizard, the VENU360 will automatically set the limiters and gain structure between the VENU360 and amplifiers. If your amplifiers are not available in the Setup Wizard, you should choose the “Not Listed??” option, meaning limiter settings will not be automatically set. The following section explains how you would go about manually optimizing the system's gain structure and set the limiters to protect your amplifiers from clipping.

Gain structure refers to aligning the gain of each device so that the input circuits of all devices clip at the same time – this optimizes the noise floor of the sound system and allows you to know exactly how much headroom you have in the entire system by simply looking at the mixer's main output meter. Oftentimes, PA systems are setup with the amplifier input attenuator controls turned all the way up, in the incorrect assumption that this is the only way to get the maximum level out of the sound system. Setting up your amplifiers in such a manner can help prevent someone from raising your amp attenuators and damaging the system (this is sometimes required for permanent install applications and requires the output gain be reduced in the device feeding the amplifier), however, system noise may be increased by doing so.

Amplifiers are fixed gain devices. Turning down the amplifier input attenuators does not change the potential output of the amplifier, it only requires more input voltage to get full output power. Many amplifiers will clip with an input level greater than +6 dBu when the input attenuators are turned all the way up. Most mixing consoles can deliver well over +18 dBu of output level before clipping. This means that with your amps turned all the way up, you are sacrificing at least 12 dB of headroom, resulting in poorer noise performance and the potential risk of clipping the amplifier and damaging loudspeakers. By adjusting the amplifier controls properly, you can maximize your system's noise performance and protect your loudspeakers. The following diagram illustrates the previous example and shows how it can be easily remedied by simply lowering the input attenuators on the amplifier to apply 12 dB of attenuation, effectively fitting the signal within the operational headroom constraints of the amp.

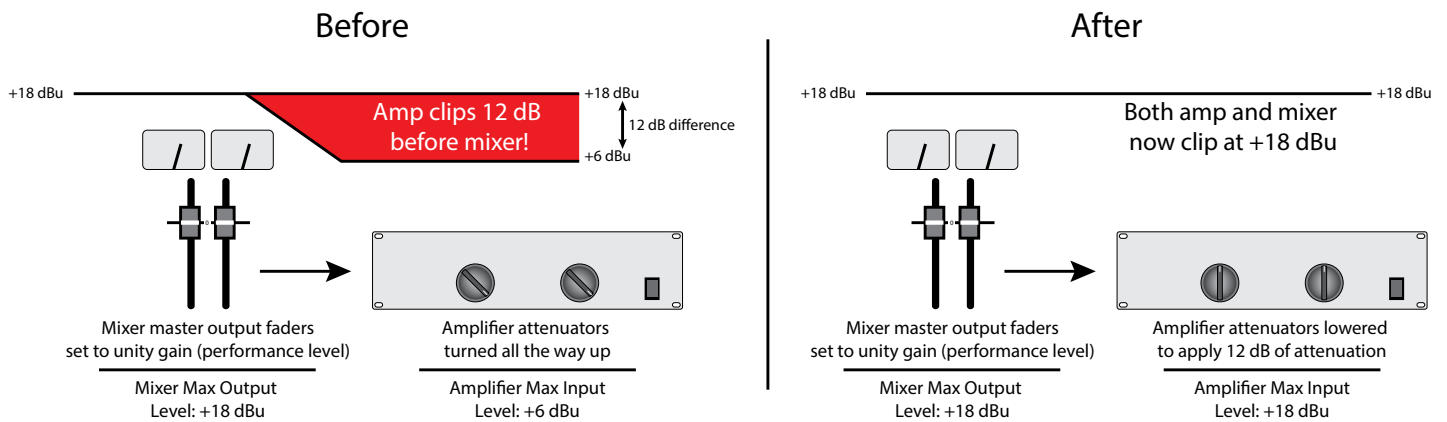

One way to calibrate the gain structure is to play pink noise through the entire system and adjust each gain stage in the signal chain in succession using the clip indicators on each device. If there is no clip indicator on your mixer then use the output meters; most reputable console manufacturers use red LEDs at the top of the meters to show the onset of clipping.

To calibrate the system's gain structure and VENU360 limiters:

WARNING! Although it is highly unlikely that you are using tube amplifiers, since they are not practical for sound reinforcement use, please note that most tube amplifiers can be damaged if operated without a load (the speaker) connected. Therefore, do not perform the following procedure if using tube amplifiers unless you have verified they can be operated without a load connected. This is not an issue with modern solid state amplifier designs.

1. You will need to send a pink noise signal through the entire system to perform this calibration procedure. Although the VENU360 does have a built-in signal generator capable of generating pink noise, this will not help with optimizing the gain structure between the mixer and VENU360 as the mixer's output meters need to be active and available for reference. Some mixers have a built-in pink noise generator, which will work. You can also check your smartphone's app store, as there are many audio apps now available which have a built-in pink noise generator, or search online for a pink noise sample and burn it to a CD or load it into your portable music player or smartphone.

TIP: The VENU360's built-in signal generator can be used for calibrating gain structure between the VENU360 and amplifiers. In many cases, calibrating the gain structure between the mixer and VENU360 may not be absolutely necessary as you can figure out where to set the VENU360's analog input clip levels and input Router/Mixer gains based on the mixer's max output level spec alone. For example, if your mixer's maximum output level spec is +26 dBu, the VENU360's analog input clip levels (located in the Utility menu) can be set to +28 dBu then the input Router/Mixer gains set to +2 dB. The mixer outputs and VENU360 inputs will now both clip at the same level (+26 dBu).

2. Once you have your pink noise signal, power down the sound system, disconnect all the loudspeakers from the amplifiers, and turn all amplifier attenuators all the way down.
3. Now, turn the mixer, VENU360, and amplifiers back on. Go into the VENU360's limiters and ensure they are all turned off, OVER EASY is turned off, AUTO is turned on, PEAK STOP PLUS is turned on with OVERSHOOT set to 3, and their

THRESHOLD's are set all the way up to 0.0 dB. Note that once the first limiter has been set you can use the **COPY/PASTE** buttons to copy the settings to all other limiters. Also, turn off all VENU360 input EQs (speaker tuning EQs should be left on), dynamics processing, and Sub Synth modules and ensure all "input" and "mid" Router and Mixer module gains in the VENU360 are set correctly to provide unity gain – further adjustments can be made later in the process once signal is fed through the system.

4. The VENU360 has analog input and output clip level settings in the Utility menu. See **'Analog Input/Output Clip Levels'** under **'Utility Menu' on page 92** for more information on these settings. These are used to adjust gain stages in the analog domain (instead of in DSP) so that better signal-to-noise performance can be achieved. Go into the Utility menu and adjust the ANALOG INPUT CLIP LEVEL settings to match the maximum output level of your mixer. You should be able to find this spec in your mixer's manual. If your mixer's maximum output level spec doesn't exactly match one of the settings in the VENU360, set the VENU360's ANALOG INPUT CLIP LEVELS to the closest setting above the spec. For example, if your mixer has a maximum output level of 26 dBu, set the VENU360's ANALOG INPUT CLIP LEVEL to 28 dBu.
5. Play the pink noise signal through the mixer. Raise the mixer's main output faders until the mixer's output clip indicators just begin to light.
6. Now go into the input Router/Mixer for the first VENU360 input channel. The goal is to get the VENU360's inputs to clip at the same point as the mixing console's outputs. If using an input Mixer module in the VENU360, enter its menu and calibrate the corresponding input channel's gain until the clip indicator in the graph just begins to light. If using an input Router, calibrate the Router's master gain until the master clip indicator in the graph just begins to light. Repeat this step for any additional inputs you are using on the VENU360. If using an input Mixer and mixing channels, you will want to lower the master gain to compensate for the summing of the input Mixer channels (i.e., 6 db for two channels and an additional 3 db for each additional channel being summed). This will maintain unity gain through the Mixer module.
7. Now, go to each amp channel and slowly raise its attenuator until the amp channel's clip LED just begins to light.

TIP: If any of your amp channels clip with the attenuators all the way down or you can't turn them up very far before clipping occurs, you will want to lower the corresponding analog output clip levels located in the Utility menu. See **'Utility Menu' on page 92** for more information on these settings.

TIP: Once all amp attenuators have been set, you may want to take note of their position using gaffers tape or some other non-permanent means. This way you can retain the reference amp attenuator settings above which the amplifiers will clip.

8. Go into one of the VENU360's limiter modules. Turn the limiter on and slowly lower the THRESHOLD parameter until the corresponding amp channel's clip LED stops lighting. Don't lower the limiter THRESHOLD parameter too far, just far enough to hold the signal level just below the clip point of the connected amplifier channel. Repeat this step for each VENU360 output channel used in the system.
9. Turn down the pink noise and main output faders on the mixer then power down the system.
10. Reconnect your speakers to your amps.
11. Power up the system, ensuring to power up your amps last.

The system is now optimized to provide the loudest levels possible, with adequate headroom between devices, and with the least amount of noise. Now sit back, play your reference music through the system, and slowly raise your mixer's main output faders. When the mixer's main faders are set to approximately unity gain (0), the system will now provide the highest sound pressure level it is capable of without clipping. If the system is not loud enough when the mixer is set just below the output clip point, this is an indication that the system is inadequate for the application. If this happens, you can try adding VENU360 compression with make-up gain as it may provide a slightly higher system output level. If the system level is still inadequate for the venue, you may want to consider amplifiers with greater output power, but still within the power rating of your loudspeakers,

or additional speakers and amplifiers. Most loudspeaker manufacturers recommend an amplifier which provides 1.5 to 2 times the rated RMS power of the speaker. If the sound system is too loud when the mixer's main faders are set to unity, this indicates that you have more power than is required for the venue and you can simply turn down your mixer's main output faders until the desired performance level is achieved.

4. Balance The System's Frequency Response

It's now time to balance the system's overall frequency response by fine-tuning the amplifier attenuators. This step is not absolutely necessary, but is recommended as it can help smooth out the system's frequency response before applying any system EQ, which translates to smaller gain adjustments in the EQ and better sound quality. You can perform this procedure while listening to your reference music and do it by ear or use the dbx RTA-M reference mic and RTA. The music you choose to use for reference should contain full-bandwidth audio and should be something you have spent much time listening to and are extremely familiar with.

Since the gain structure is already set and the limiters calibrated, you will not want to raise your amplifier attenuators, as we've already determined when we set the gain structure, setting them any higher will cause the amplifiers to prematurely clip. Instead you will want to lower the amp attenuators for whichever frequency range (e.g., low, mid, etc.) is too loud. For example, if the system has too much midrange, turn down your mid amp attenuators. If the system has too much high end, turn down the high amp attenuators. The goal is to achieve a balanced frequency response throughout the system.

TIP: If you made any additional adjustments to amp attenuator settings in this step, you may want to make additional marks around the attenuators to indicate these updated positions for future system use.

5. EQ The System In The Venue

Now that the system is optimized for use, it's time to EQ the sound system in the venue. The VENU360's built-in AutoEQ Wizard does a great job of equalizing a sound system in a timely manner so we recommend using it. Once the AutoEQ Wizard is complete, you can adjust the four "user" bands in the AutoEQ menu (bands 11-14) to add to the equalization. Or, if you prefer, you can directly edit any of the 10 AutoEQ bands set by the AutoEQ Wizard (bands 1-10); if you want to get back to the original settings set by the AutoEQ Wizard, just change the FLATTEN parameter from "MANUAL" back to "AUTOEQ".

TIP: Using AutoEQ bands 11-14 ("user" bands) to tailor the AutoEQ response to your liking allows the settings to be retained even after subsequent runs of the AutoEQ Wizard. This means that each time you run the AutoEQ Wizard, your manual "user" adjustments will automatically be applied on top of the AutoEQ'ed response curve. If you decide to manually adjust AutoEQ bands 1-10, such manual settings will be wiped out each time the AutoEQ Wizard is run.

The following instructions can be used to fine-tune the system after running the AutoEQ Wizard or to manually EQ the sound system in the event you don't have the dbx RTA-M measurement microphone. Note that using the DriveRack VENU360 control app on a mobile device allows you to walk around the venue while making EQ adjustments.

To EQ the system by ear:

1. Choose a full-bandwidth music reference source that you are familiar with. Play the reference music through the sound system. Turn the music up as close as possible to performance level (the level at which the system will be operated during use).
2. Walk around the venue and listen to the sound system. Does it sound thin, bright, or muddy? Try to get an overall assessment of how the system sounds and what kind of improvements can be made.
3. Go into the VENU360's AutoEQ (AEQ) module and adjust the bands to taste. If you prefer to use graphic EQ rather than parametric EQ, you can insert a GEQ module into one of the VENU360's input insert slots using Configuration

mode, see **‘Configuring Processing Module Insert Types’ on page 30**. If using a GEQ to tune the system, try each of the available QUICK CURVE options available in the menu to see if they get you close to the tone you’re after. Make any further adjustments using the GEQ’s individual frequency bands.

4. Repeat for stage monitor, zone, or delay fill speakers if required.

6. Ring Out The System With AFS

After system EQ has been applied, performing the ring-out procedure allows you to squeeze a little more gain out of the system before the onset of feedback. The AFS Wizard does a great job of taking the guesswork out of the ring-out procedure. However, if you prefer to ring out the system manually, you can.

To manually ring out the system using AFS:

1. Set up all the microphones then perform a sound check and set up a rough mix for all microphones which will be active during the performance. When done, take note of the mixer’s main output fader positions (or aux send master if ringing out stage monitors). Your target gain when ringing out the system will be around 2-5 dB above this “performance level” setting.
2. If noise gates are being used on any of the active mics – including vocal effect processors with built-in noise gates – bypass them before ringing out the system. You can re-enable them once the ring-out procedure is complete.
3. Have the musicians stop playing and turn the main mixer faders (or aux send master if ringing out stage monitors) all the way down.
4. Go into the AFS module.
5. Turn AFS on.
6. Go to the MODE parameter and set it to FIXED.
7. Go to the TYPE parameter and select the desired width for the Fixed filters – select the MUSIC option for the most precise and inaudible feedback suppression. See **‘Advanced Feedback Suppression (AFS)’ starting on page 56** for further information on the available AFS TYPE options.
8. Go to the FIXED FILTERS parameter and set it to 12.
9. Slowly raise the main mixer faders (or aux send master if ringing out stage monitors) until you reach your target gain (described in step 1) or run out of Fixed filters, whichever happens first.
10. Now lower the main mixer faders (or aux send master if ringing out stage monitors) back to performance level (the level at which you had the mixer’s main faders or aux send master during sound check in step 1).

TIP: AFS analyzes a mono-summed signal when ringing out stereo and LCR systems and if these signals are out of phase, AFS will not be able to properly detect the feedback and suppress it. If feedback occurs and is not promptly suppressed by AFS, it could indicate that there are phase issues with either the signals coming from the mixer or loudspeakers. If this happens, ensure the signals coming from the mixer are all in phase with each other and all loudspeakers are in phase with each other.

11. Lower the FIXED FILTERS setting to change all unused Fixed filters to Live filters. Make sure you don’t lower it too far as you don’t want to remove set Fixed filters.
12. Set the AFS MODE to LIVE.
13. Go to the TYPE parameter and select the desired width for the Live filters – select the SPEECH/MUSIC option for the best all around real-time feedback protection. See **‘Advanced Feedback Suppression (AFS)’ starting on page 56** for further information on the available AFS TYPE options.
14. The system is now ready for use and any available Live filters will be available for automatic, on-the-fly feedback

suppression.

NOTE: When ringing out the system in Fixed mode, any sound detected by AFS will trigger filters to be set. Therefore, make sure the microphones are active, but there is no signal present at the mics when AFS is active in Fixed mode.

7. Add Finishing Touches

The system is now ready for use. Additional processing can now be applied to add the finishing touches. For example, subharmonic synthesis can be applied to enhance the system's bass response and compression can be applied to add a touch of mixbus-style compression. For tips on setting these processing module settings, see '**Compressor (CMP) Module**' on **page 71** and '**Subharmonic Synth (SUB) Module**' on **page 82**.

Processing Modules & Parameters

This section of the manual provides descriptions of all the processing modules available in the VENU360, their associated parameters, and how to edit them.

Inputs Module

The standard VENU360 model has 7 fixed inputs. The input assignments are: IN1: Analog1, IN2: Analog2, IN3: Analog3, IN4: AES1, IN5: AES2, IN6: AES3, and IN7: AES4. The VENU360-B and VENU360-D models allow these inputs to be configured between the standard inputs listed above or BLU link/Dante channels depending on model. See **'Configuring BLU Link / Dante Inputs'** on page 26 for information on editing BLU link and Dante input channel assignments.

The Inputs module is fixed at the beginning of the processing chain and has no parameters to edit. It can be used for referencing the input channel assignments and provides direct input signal level metering and clip indication. These direct input meters and clip indicators can also be seen in the "Input Meters" home screen. See **'The Home Screens'** on page 14 for more information on the available home screens.

To view the Inputs module:

1. Press the EDIT button.

2. Select the Inputs module using the SELECT wheel and UP/DOWN buttons. Press the SELECT wheel to enter the module's menu.

3. Use the SELECT wheel or UP/DOWN buttons to navigate the menu.

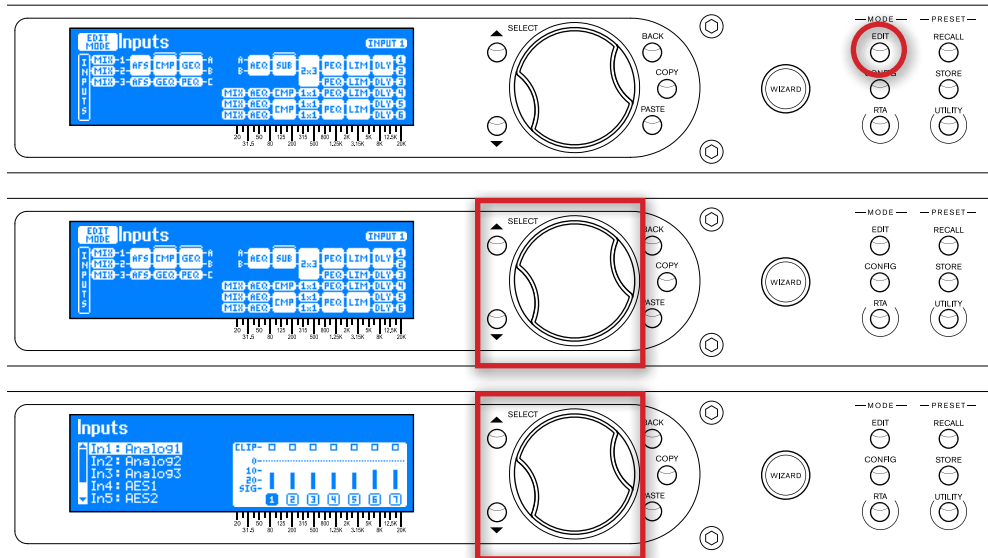

Router Module

The Router module lets you route a single signal or mono-summed signal to an input or output processing chain, see **‘Configuring Mixers/Routers’ on page 28** for diagrams and further information on available routing options. The graph in the Router indicates signal levels, clipping, master gain fader position, and master mute status.

To edit a Router module:

1. Press the EDIT button.

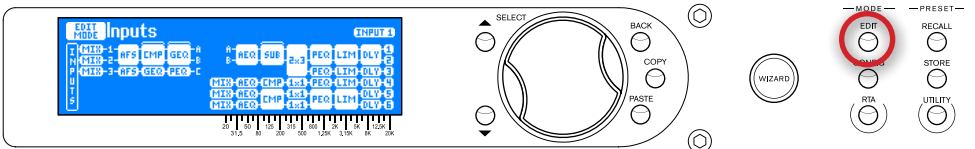

2. Select a Router module using the SELECT wheel and UP/DOWN buttons. Press the SELECT wheel to enter the module's menu.

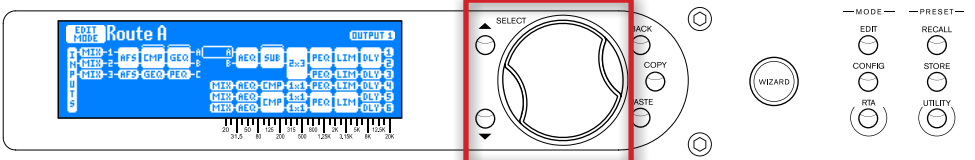

3. Use the SELECT wheel and UP/DOWN buttons to navigate the menu and edit parameters.

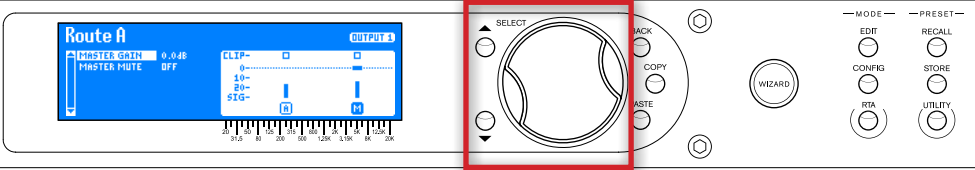

TIP: When in a menu, pressing and holding the **EDIT** button for approximately 2 seconds will advance to the next module below in the configuration map, wrapping around through the available modules. This allows quick navigation between menus of a column and improves efficiency when performing repetitive tasks within like modules.

Router Parameters

- MASTER GAIN [-120dB - 6dB]**
Adjusts the output gain of the Router.
- MASTER MUTE [ON, OFF]**
Turns the master mute on and off. When this mute is on, an “X” will appear in the graph, indicating the master is muted and no signal will pass from the Router module.

NOTE: The front-panel Mix/Route meters monitor the signal level from the configured input Mixers/Routers. The front-panel Mix/Route Mute buttons enable the “MASTER MUTE” parameters inside the configured input Mixers/Routers.

Mixer Module

The Mixer module lets you mix multiple signals together and feed them to an input or output processing chain, see **'Configuring Mixers/Routers' on page 28** for diagrams and further information on available mixing options. There are three types of Mixer modules available in the VENU360, they are: Input Mixers, 123 Mixers, and ABC Mixers. 123 and ABC Mixers are only available on the output processing chains and allow you to mix signals from either the 1/2/3 or A/B/C bus points. Input Mixers allow you to mix the direct input signals pre any VENU360 processing and can be configured on the input or output processing chains. The graph in the Mixer indicates channel selection, signal level, gain fader position, clipping, and mute status for each channel including the master.

To edit a Mixer module:

1. Press the **EDIT** button.

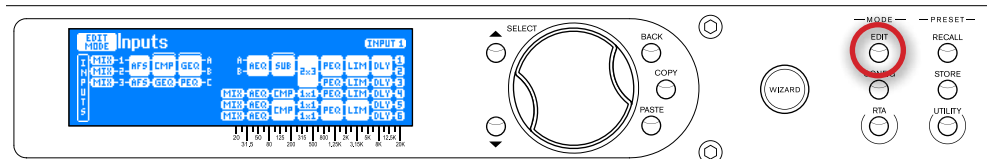

2. Select a Mixer module using the **SELECT** wheel and **UP/DOWN** buttons. Press the **SELECT** wheel to enter the module's menu.

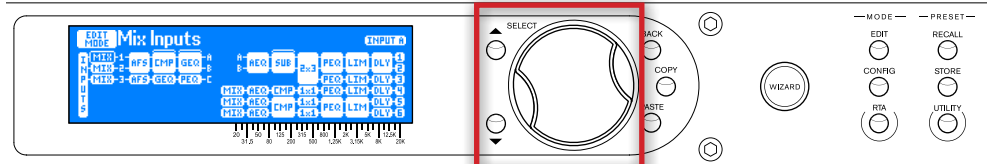

3. Use the **SELECT** wheel and **UP/DOWN** buttons to navigate the menu and edit parameters.

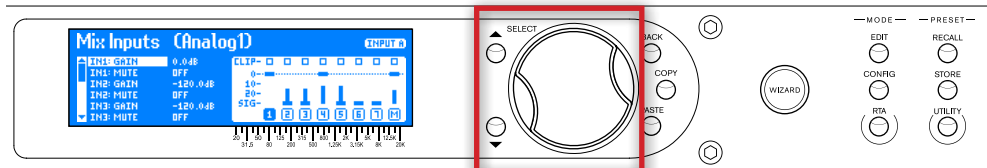

TIP: When in a menu, pressing and holding the **EDIT** button for approximately 2 seconds will advance to the next module below in the configuration map, wrapping around through the available modules. This allows quick navigation between menus of a column and improves efficiency when performing repetitive tasks within like modules.

Mixer Parameters

- **"X:" GAIN [-120dB - 6dB]**

Adjusts the gain of the indicated Mixer module channel. Depending on the type of mixer selected, the gain indicator could be "1", "2", "3", "A", "B", "C", or "IN1" - "IN7".

- **"X:" MUTE [ON, OFF]**

Turns the mute of the indicated Mixer module channel on and off. Depending on the type of Mixer selected, the mute indicator could be "1", "2", "3", "A", "B", "C", or "IN1" - "IN7". When a mute is on, an "X" will appear in the graph, indicating a channel is muted and no signal from this channel will pass through the Mixer module.

- **MASTER GAIN [-120dB - 6dB]**

Adjusts the output gain of the Mixer.

- **MASTER MUTE [ON, OFF]**

Turns the master mute on and off. When this mute is on, an "X" will appear in the graph, indicating the master is muted

and no signal will pass from the Mixer.

NOTE: The front-panel Mix/Route meters monitor the signal level from the configured input Mixers/Routers. The front-panel Mix/Route Mute buttons enable the “MASTER MUTE” parameters inside the configured input Mixers/Routers.

Advanced Feedback Suppression (AFS) Module

Feedback is caused when an in-phase audio loop is created between an input transducer (such as a guitar pickup or microphone) and an output transducer (a loudspeaker). The VENU360 includes the exclusive AFS® (Advanced Feedback Suppression) algorithm to help combat this dreadful phenomenon.

The updated AFS algorithm in the VENU360 (first introduced in the DriveRack PA2) offers the following enhancements:

- It's faster at eliminating the offending feedback frequency.
- It can better determine what is actually feedback, making it far less likely to set false triggers on feedback-like audio sources, such as a flute.
- It can better determine how much attenuation is required to notch out the feedback, resulting in notch filters which aren't as deep and even less audible.
- It prevents the filters from being too narrow to tackle feedback at lower frequencies.
- It has better frequency resolution, which provides pinpoint accuracy and uses the narrowest filters possible.
- When lifting Live filters, the filters are lifted more gradually to better determine if it is safe to lift the filter, preventing blaring feedback from suddenly returning.

AFS uses precision frequency detection and state-of-the-art processing to determine the exact range of feedback frequencies to remove (instead of indiscriminately removing large sections of audio). In the past, graphic equalizers were used to eliminate feedback from a system. This was an acceptable method for eliminating feedback, but when this method is put up against precision notch filters, such as those found in AFS, it becomes very evident that using graphic equalizers for this task severely affects the tone of the system. With AFS, the precision filters remove only a fraction of the frequency spectrum, eliminating the feedback with far less audible artifacts. The below diagram shows a comparison of filter widths between the AFS filters and conventional 1/3 octave graphic EQ filters.

Filter Precision Comparison Chart

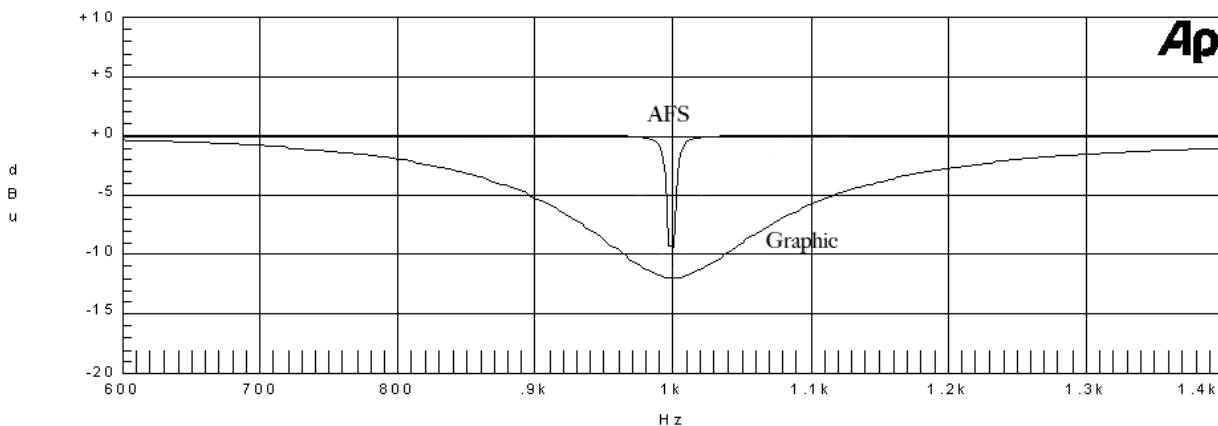

TIP: AFS works best when the signal entering the VENU360's inputs is sufficient. This requires proper gain staging between the mixer and VENU360. If the signal level is too low, AFS may be slow to respond to feedback. See **'Manually Optimizing A System Using The VENU360' on page 49** for further information on gain structure and manually ringing out the system with AFS.

NOTE: Where applicable, signals sent to the AFS detector for analysis are mono summed. If one of these summed signals is polarity inverted, AFS will not be able to detect feedback – as the feedback will cancel out before being analyzed. If you experience problems with AFS not detecting feedback, check the polarity of the signals/cables feeding the VENU360's inputs to ensure they have the same polarity.

AFS modules are fixed and are located in the input processing stage. The following section provides a description of each of the AFS module parameters and how to edit them.

To edit an AFS module:

1. Press the EDIT button.

2. Select an AFS module using the SELECT wheel and UP/DOWN buttons. Press the SELECT wheel to enter the module's menu.

3. Use the SELECT wheel and UP/DOWN buttons to navigate the menu and edit parameters.

TIP: When in a menu, pressing and holding the **EDIT** button for approximately 2 seconds will advance to the next module below in the configuration map, wrapping around through the available modules. This allows quick navigation between menus of a column and improves efficiency when performing repetitive tasks within like modules.

AFS Parameters

- **AFS [OFF, ON]**

Turns the AFS module on and off. If AFS is off, the filters are bypassed and the algorithm is halted (the filters are not updated). If AFS is on, the filters are active and they are updated according to the currently selected mode (Fixed or Live).

WARNING! If AFS is turned on and filters are set (in use), be careful when turning AFS off, as all filters will be immediately removed from the signal path and sudden feedback could occur. It is recommended that you lower your mixer output levels before turning AFS off.

- **CLEAR MODE [LIVE ONLY, ALL]**

This parameter selects which filters will be cleared when you perform the clear function. If the LIVE ONLY option is selected, only the Live filters will be cleared when you perform the clear function and the Fixed filters will be left alone. When the ALL option is selected, both Live and Fixed filters will be cleared when performing the clear function.

- **CLEAR <PRESS SELECT>**

Selecting this option then pressing the **SELECT** wheel triggers the clear function, which removes set AFS filters. The clear function allows you to either clear only the Live filters or all AFS filters so you can ring out the system for a new venue. The CLEAR MODE parameter selects which filters will be cleared when performing the clear function.

WARNING! If AFS is turned on and filters are set (in use), be careful when clearing AFS filters, as all filters will be immediately removed from the signal path and sudden feedback could occur. It is recommended that you lower your mixer output levels before clearing AFS filters.

- **MODE [FIXED, LIVE]**

This parameter determines whether the AFS algorithm will set Live or Fixed filters. Select the FIXED mode option to initially ring out the system for optimal gain before feedback using the Fixed filters. Fixed filters are “static” and will remain set until you manually clear them.

Once you have rung out the system with the Fixed filters, set the mode to LIVE to further protect the system from feedback during the performance using the Live filters. In Live mode, AFS uses logic to determine what is feedback and what is not. The enhanced AFS algorithm in the VENU360 can better distinguish between program material and feedback, dramatically lowering the probability of false Live filters being set on feedback-like music content.

Live filters are “dynamic” and will update as feedback conditions change. When all of the Live filters have been set, they will begin to round robin – meaning that if all Live filters have been set and new feedback occurs, the first Live filter set will be released then re-set at the new feedback frequency location. The Live filters can be set to release after a period of time by enabling the LIVE LIFT option and adjusting the LIFT AFTER parameter. Note that when you run the AFS Wizard, AFS will automatically switch between Fixed and Live mode operation behind the scenes.

- **TYPE [SPEECH, SPEECH/MUSIC, MUSIC]**

This parameter sets the width and sensitivity of the AFS filters. The available options are:

SPEECH (Constant bandwidth of 11 Hz below 76 Hz, constant Q of 7 at or above 76 Hz)

This option is optimized for speech sound reinforcement, where wider notch filters are less noticeable. Select this option when using the sound reinforcement system for speech only. With this option selected, notch filters will be wider, but will provide the fastest, most solid protection against feedback.

SPEECH/MUSIC (Constant bandwidth of 9 Hz below 260 Hz, constant Q of 29 at or above 260 Hz)

This option is optimized for live music or speech sound reinforcement and provides the best all-around protection. It will provide the best combination of fast feedback suppression and precision, using filters slightly narrower and less audible than the SPEECH setting, but slightly faster than the MUSIC setting. If you're not sure which setting to use, select this option.

MUSIC (Constant bandwidth of 8 Hz below 927 Hz, constant Q of 116 at or above 927 Hz)

This option is optimized for live music sound reinforcement and offers the highest level of sonic quality. When this option is selected, the AFS algorithm will zero in on the offending feedback frequency, while leaving the surrounding frequencies unscathed. With this option selected, the AFS filters will take slightly longer to set than when using the SPEECH/MUSIC setting, although the difference in time will be quite negligible.

NOTE: To guarantee that feedback is suppressed using the minimum number of filters possible, AFS may automatically widen filters. For example, if you had selected the MUSIC setting and an adjacent frequency is feeding back, AFS will detect both frequencies, and if they are in close enough proximity, will set a single, wider filter rather than two narrow filters. Using a single, wider filter rather than two narrow filters will not alter the sonic quality and will ensure that the maximum number of filters will always be available for use. Automatically adjusted filter widths will never be any wider than the SPEECH setting.

TIP: You can change the TYPE parameter at any time. This allows you to use narrow notch filters in combination with wider notch filters. For example, you could set the TYPE parameter to MUSIC then ring out the system in Fixed mode, switch over to Live mode, then set the TYPE parameter to SPEECH/MUSIC for the Live filters. This would allow you to use the extremely narrow MUSIC notch filters for the Fixed filters (providing the best sound quality possible), then use the slightly faster, wider SPEECH/MUSIC notch filters for the Live filters (providing slightly faster feedback suppression during the performance).

- **FIXED FILTERS [0 - 12]**

This parameter sets how many of the AFS filters will be allocated as Fixed filters. After selecting how many filters will be allocated as Fixed filters, any remaining filters will be allocated as Live filters. There are a total of 12 AFS filters available, so the simple formula is: Total Filters Available - Selected Number of Fixed Filters = Number of Live Filters. For example, if you select a FIXED FILTER setting of 8, you will have 4 Live filters available for use (12 - 8 = 4).

TIP: Since it's not really possible to predict exactly how many Fixed filters you may need, a good setting to start with is the default setting of 6. If after ringing out the system, you feel you need to squeeze a little more gain out of the system before feedback, you can increase the FIXED FILTERS setting and run the AFS Wizard again or manually ring out only the newly added Fixed filters in the AFS menu.

NOTE: If the FIXED FILTERS setting is changed after filters have been set, the filters will be cleared one by one as you increase or decrease the setting. For example, if you decrease the FIXED FILTERS setting by one, the last Fixed filter set will be cleared because the Fixed filter will be changed to a Live filter. Likewise, if the FIXED FILTERS setting is increased by one (and thus the number of Live filters goes down), then the first Live filter set will be cleared. The Fixed/Live filter allocation is indicated above the graphic in the AFS menu. "F" indicates Fixed filters and "L" indicates Live filters. A highlighted F or L indicates a filter that is set, or in use.

- **LIVE LIFT [OFF, ON]**

This parameter turns the LIVE LIFT feature on and off. When turned on, a timer is enabled. Turn LIVE LIFT on when you want AFS to lift (release) Live filters after a predetermined time set by the LIFT AFTER parameter. Higher fidelity can be restored to the system by lifting Live filters when they are no longer needed (for example, if a singer steps to the front of the stage and triggers feedback, setting a Live filter, and then backs off).

- **LIFT AFTER [5S - 60M]**

When the LIVE LIFT parameter is turned on, this parameter determines how long it will take before AFS will attempt to remove a set Live filter. The selectable options range from 5S (5 seconds) to 60M (60 minutes). The updated AFS algorithm in the VENU360 will slowly release Live filters by 3 dB increments to determine if it is safe to remove them. If it gets to 0 dB and no feedback reoccurs, the filters are completely lifted. If feedback attempts to reappear while releasing, the filters are once again set and the timer resets. This helps prevent a sudden reoccurrence of blaring feedback in the event a Live filter is still needed and needs to remain set.

- **SENSITIVITY [-6dB - +6dB]**

This parameter adjusts the input level feeding the AFS detector and makes AFS more or less prone to mark a signal as feedback.

When AFS is set to Fixed mode, SENSITIVITY adjusts the feedback level perceived by AFS. For example, setting SENSITIVITY to +6 will allow AFS to detect the feedback and notch it out more quickly. Conversely, setting SENSITIVITY to -6 will cause AFS to be a little more hesitant to set a filter on the feedback until it reaches a higher level.

When AFS is set to Live mode, SENSITIVITY will work the same way as during Fixed mode on pure feedback tones, but will also affect where AFS draws the line between feedback and music. If you find that AFS is being too hesitant to set

filters on feedback during your live performance, try increasing the SENSITIVITY setting. If you find AFS mistaking an instrument for feedback, try decreasing the SENSITIVITY setting.

- **HIGH PASS [0Hz - 500Hz]**

This parameter places a high-pass filter in the AFS detector path. If you don't want AFS to have the ability to set any filters below a set frequency (for example, if you don't want AFS to notch any frequencies below 100Hz), adjust this parameter to the frequency below which you want AFS to ignore.

- **SELECTED FILTER [1 - 12]**

This parameter selects between the available filters in the graph and provides information on each. As you select each filter, the filter blocks above the graph on the right-hand side of the menu will indicate which filter is selected. "L" represents a Live filter and "F" represents a Fixed filter. If the selected filter has been set, the block will be filled in and the frequency, Q, and amount of attenuation will be shown for the selected filter above the graph. If no AFS filter has been set for the selected filter, no information will be displayed.

Automatic Gain Control (AGC) Module

Automatic Gain Control is used in zone applications to keep the average level of a signal constant. Think of it as a slow reacting compressor/upward expander. It accomplishes this by allowing you to set a target level and a window size around the target (the window size sets how much the signal level is allowed to deviate from the target). The algorithm will then add gain when the signal level drops below this window. The LOW THRESHOLD and MAX GAIN parameters prevent large amounts of gain from being applied when no signal is present. A faster-acting limiter is included in the algorithm to quickly limit signals which exceed the ceiling of the window, thereby preventing clipping and distortion and keeping the signal level within the window.

AGC modules can be inserted in either the input or mid processing insert slots, see **'Configuring Processing Module Insert Types'** on page 30 for more information on configuring inserts. The following section provides a description of each of the AGC module parameters and how to edit them.

To edit an AGC module:

1. Press the EDIT button.

2. Select an AGC module using the SELECT wheel and UP/DOWN buttons. Press the SELECT wheel to enter the module's menu.

3. Use the SELECT wheel and UP/DOWN buttons to navigate the menu and edit parameters.

TIP: When in a menu, pressing and holding the **EDIT** button for approximately 2 seconds will advance to the next module below in the configuration map, wrapping around through the available modules. This allows quick navigation between menus of a column and improves efficiency when performing repetitive tasks within like modules.

AGC Parameters

- AGC [OFF, ON]**
 Turns the AGC module on and off.
- TARGET [-40dB - -10dB]**
 This parameter sets the desired average output level. If the average level of the signal rises above the set target, the level will be reduced. If the average level of the signal is below the target, gain will be added.
- MAX GAIN [1dB - 20dB]**
 This parameter adjusts the maximum amount of gain that can be added by AGC.

- **WINDOW [1dB - 10dB]**

This parameter sets the amount of target level deviation allowed. For most applications, a window of 2 to 3 dB maintains the signal adequately. The AGC Window Indicator (shown to the right) indicates when the input signal level is below the window, in the target region, or above the window.

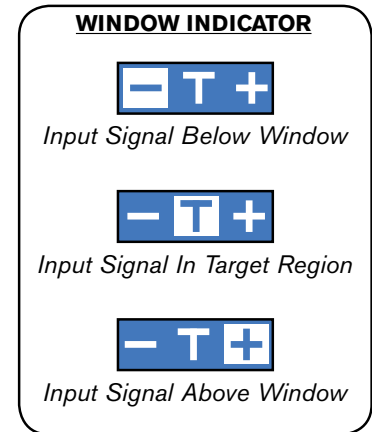

- **LOW THRESHOLD [-80dB - -50dB]**

Sets a lower limit on AGC processing. When the signal level falls below this setting, AGC will no longer try to add gain. This prevents AGC from adding gain and raising the system's noise floor when no signal is present.

- **ATTACK [1s - 10s]**

Adjusts how fast AGC will reduce gain when the signal level is above target.

- **RELEASE [10dB/s - 0.1dB/s]**

Adjusts the rate of gain increase when the signal level drops below target.

- **LIM THRESHOLD**

AGC is designed to add or remove gain slowly so that the overall response will sound natural. Because of its slow nature, a limiter is provided to control the loud, fast-acting signals. The LIM THRESHOLD parameter adjusts the level at which limiting will occur and can be set from the top of the AGC window up to 0dBFS. The Limiter Threshold Indicators (shown to the right) indicate when signal is below threshold or above threshold.

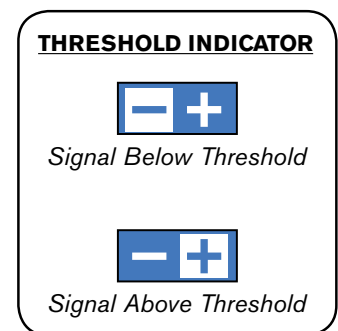

- **LIM AUTO [OFF, ON]**

Turns Auto mode for the AGC Limiter on and off. When turned off, limiter attack and release times will be determined by the LIM ATTACK and LIM RELEASE parameters. When turned on, limiter attack and release times will be program-dependent, meaning they will adjust automatically and dynamically based on input signal characteristics. When LIM AUTO is on, manual LIM ATTACK and LIM RELEASE settings will be ignored.

- **LIM ATTACK [100µs - 200ms]**

Sets the speed at which the AGC Limiter starts to reduce the signal level once it has crossed threshold. When LIM AUTO is on, this parameter is ignored and set dynamically.

- **LIM RELEASE [360dB/s - 5dB/s]**

Sets the rate at which the AGC Limiter will come out of gain reduction once the signal level drops back below threshold. When LIM AUTO is on, this parameter is ignored and set dynamically.

Delay (DLY) Modules

There are three Delay module types available in the VENU360, they are: the Backline Delay (input), Fill Delay (mid), and Alignment Delay (output). Their names are merely identifiers used to differentiate them and describe their intended purpose, however they are all identical in operation, just located at different points in the signal path. Each of the three Delay module types provide up to 1000ms of delay time. When the signal passes through all three cascaded Delay modules, up to 3000ms of delay time can be achieved through an input-to-output signal chain.

The Alignment Delay modules are located at the end of the output chain and can be used to time align loudspeaker drivers which require it. Typically, driver alignment delay is only required when configuring multi-way loudspeaker systems. Driver alignment delay is required because of the physical offset which exists between the different drivers within the loudspeaker cabinet or system, and when you bypass the internal passive crossover circuit in a speaker enclosure, you must make up for these differences in distance. Because of this physical offset, the sound emanating from each driver will reach the listeners' ears at different times, creating phase anomalies in the frequency regions where multiple drivers reproduce the same frequencies (the frequency range in close proximity to the set crossover frequencies). The Alignment Delay modules provide up to 1000ms of delay time on each output which is way more than will ever be required for aligning drivers, but this allows them to be used for delay fill or zone applications as well, if required. This also has the added benefit of freeing up the "mid" insert slot so another processing module type can be configured and utilized.

Driver alignment delays are included with speaker tunings, so when you select a specific model of bi-amplified or tri-amplified main speaker in the VENU360's Setup Wizard, driver alignment delays will automatically be entered for you based on the model you selected. However, depending upon where you place your subwoofers or the type of subwoofers used, you may need to enter a delay offset to take them into account as well. If you place your mains directly on top of your subs or use stand mounts that mount your mains above your subs and your subs are of the front-loaded variety, you likely won't have to worry about a delay offset between your mains and subs. If you're not sure, take a look at one of your speaker stacks from the side perspective and ask yourself, "is the woofer's voice coil in my main speaker physically aligned with the subwoofer's voice coil?" You should be able to get a good idea if you may have to apply some delay offset for your subs or simply reposition your mains on top of the subs, if possible. Note that small differences in distance (e.g., a few inches) between low and sub drivers is negligible and should not be of much concern, due to the large size of these low-frequency waveforms.

If your subs are placed off to the side of the stage or somewhere other than between the mains or under the mains (anywhere not aligned with the mains when viewed from the side perspective), you will likely need to manually apply some driver alignment delay. If you do need to apply driver alignment delay to compensate for sub placement, you can calculate the difference in distance between the sub and "sweet spot" (the audience position which forms an equilateral triangle with the main speakers) and the mains and sweet spot, then enter this value into the corresponding driver alignment delay (i.e., the cabinet which is further forward will need to be "pushed back" or delayed). If the subs are located further back from the mains, you will have to apply the delay to the mains. If the subs are located further forward than the mains, the driver alignment delay will have to be applied to the subs.

The Backline Delay module can be inserted in an "input" processing insert slot and is used for a different purpose, see **'Configuring Processing Module Insert Types' on page 30** for more information on configuring inserts. Once your driver alignment delays have been dialed in, backline delay can be used to apply a delay to the entire Front of House (FOH) system. By applying this backline delay, the acoustic sound emanating directly from the instruments on stage (drums, guitar amps, horns, etc.) can be positively reinforced by the FOH system. To set the backline delay, measure or approximate the distance between the instrument furthest back on stage (usually the drums and/or guitar amps) and the main FOH speakers then enter this distance into the Backline Delay module (the VENU360 allows you to enter the delay time setting in feet, meters, or milliseconds – no calculation required). Don't forget to take your driver alignment delays into account, if applicable. For example, if you've placed your subs to the side of the stage and delayed your mains to align them, the mains delay would need to be subtracted from the calculated backline delay. You can also try simply dialing this in by ear, by standing in front of the stage and wirelessly adjusting the input delay LENGTH, using the VENU360 control app.

Fill Delay modules can be inserted in the "mid" processing insert slots just before the Crossover module, see **'Configuring Processing Module Insert Types' on page 30** for more information on configuring inserts. The Fill Delay module can be used for applications requiring delayed loudspeakers to cover listening areas which are obstructed or unable to be supplied

the acoustic signal from the main FOH system (e.g., balcony delay fills, tower delay fills, etc.).

Each of the Delay module menus will show “global” status of all Delays in the configured preset, so you can see exactly where Delay modules have been configured, which modules are turned on, and if delays have been set – as shown in the below graphic.

Delay Fill Modules

Icon Descriptions

- Currently Selected Delay Module
- Delay Module Is Turned Off
- Delay Module Is Turned On
- No Delay Module Configured

The following section provides a description of each of the Delay module parameters and how to edit them.

To edit a Delay module:

1. Press the EDIT button.
2. Select a Delay module using the SELECT wheel and UP/DOWN buttons. Press the SELECT wheel to enter the module’s menu.
3. Use the SELECT wheel and UP/ DOWN buttons to navigate the menu and edit parameters.

TIP: When in a menu, pressing and holding the **EDIT** button for approximately 2 seconds will advance to the next module below in the configuration map, wrapping around through the available modules. This allows quick navigation between menus of a column and improves efficiency when performing repetitive tasks within like modules.

Delay Parameters

- **DELAY [OFF, ON]**
Turns the selected Delay module on and off.
- **LENGTH [0ms/0ft/0m - 1000ms/1127ft/343m]**
Sets the delay time or length. Each Delay module has up to 1000ms of delay time available. Delay length is displayed in all units (i.e., milliseconds, feet, and meters), making it easy to dial in the setting for the units you prefer.

Compressor (CMP) Module

A compressor is used to compress the dynamic range of the audio signal, bringing up the lower-level portions of the signal and restricting the higher-level portions of the signal. In live sound applications, it is common to compress the audio at different stages in the signal chain. For example, you may apply compression to individual instruments using the mixer's insert points and/or a group of instruments using the mixer's bus or group inserts. You can also apply compression to the entire mix in order to add some additional "body" to the sound and help "glue" the mix together. It's this latter application that the Compressor module in the VENU360 was designed to address.

Typically, you want to control the dynamic range where it's needed. For example, using a compressor on an entire mix without compressing individual instruments may not improve a mix where some instruments are much more dynamic than others. The dynamic instruments still won't sit right in the mix.

The Compressor module in the VENU360 is a broadband compressor which provides overall mix compression. The Compressor can help add the final touch of dynamics processing to the mix, but should be used sparingly as this type of compression generally works best with lower ratio settings. A 1:5 to 2:1 ratio with 2-3 dB of compression should do the trick. It's subtle, but it can help add a little extra girth, punch, and level to the sound if set properly. Be careful not to apply too much compression, as doing so can have the adverse affect of making things sound "smaller", creating "pumping"/"breathing" artifacts, or exacerbating feedback.

NOTE: If using subharmonic synthesis placed before the compressor, the strong low-frequency energy from the sub-synth process can cause excessive compressor pumping/breathing. If you exhibit this type of behavior, try lowering the subharmonic synthesis level and/or the compression ratio to eliminate the artifacts, or reverse their order in the configuration.

Compressor modules can be inserted in either the input or mid processing insert slots, see '**Configuring Processing Module Insert Types**' on page 30 for more information on configuring inserts. The following section provides a description of each of the Compressor module parameters and how to edit them.

To edit a Compressor module:

1. Press the EDIT button.

2. Select a Compressor module using the SELECT wheel and UP/DOWN buttons. Press the SELECT wheel to enter the module's menu.

3. Use the SELECT wheel and UP/DOWN buttons to navigate the menu and edit parameters.

TIP: When in a menu, pressing and holding the **EDIT** button for approximately 2 seconds will advance to the next module below in the configuration map, wrapping around through the available modules. This allows quick navigation between menus of a column and improves efficiency when performing repetitive tasks within like modules.





Compressor Parameters

- **COMPRESSOR [OFF, ON]**

Turns the Compressor module on and off.

- **THRESHOLD [-60dB to 0dB]**

Sets the level at which the compressor will begin compressing the signal. For example, if the THRESHOLD is set to -10 dB, any signal which exceeds -10 dB will be compressed, while any signal lower than -10 dB will be left alone (uncompressed).

The Compressor Threshold Indicator (shown to the right) indicates when signal is below threshold, above threshold, or in the OverEasy region. Typically, you will want to set the threshold parameter so that the lower levels of the signal drop below threshold and the higher levels exceed threshold. This can easily be achieved by looking at the Threshold Indicator and adjusting the THRESHOLD parameter until the indicators alternate back and forth between the  and  icons (or , , and  icons if OVER EASY is turned on).

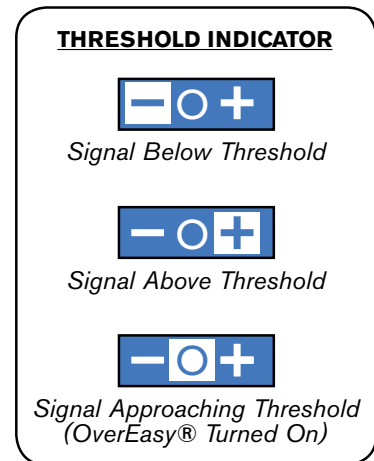

- **RATIO [1:1 to INF:1]**

This parameter determines how much compression is applied to the signal once it exceeds threshold. For example, applying a 2:1 ratio would allow the output signal level to increase by only 1 dB for every 2 dB of level increase over threshold. In other words, 1 dB of compression will be applied for every 2 dB increase in level above threshold. For light compression, choose a lower ratio. For heavy compression increase the ratio. A ratio setting of about 10:1 or higher essentially turns the compressor into a limiter. Typically, a setting of 1.5 to 2:1 will yield best results for most applications where the compressor is used.

- **GAIN [-20dB to +20dB]**

This parameter is used to compensate for the gain lost due to compression. Typically, you can look at the gain reduction meter and then apply a matching amount of gain. Or you can turn the compressor on and off to A/B the compressed signal with the uncompressed signal and adjust the gain until the two levels match. By using compression on a signal and then boosting the signal with the gain parameter, you can slightly increase the average level and create a signal that sounds a little louder than it actually is. However, care should be taken to prevent over-compression, which can cause level pumping and increase the likelihood of feedback.

- **OVER EASY [OFF, 1-10]**

One criterion that determines how a compressor will function is called the “knee”. The knee region exists at or around the compressor’s threshold setting and determines how gradual or abrupt the compression will be. A compressor with hard-knee characteristics won’t compress the signal until it exceeds threshold and will provide a more abrupt and aggressively compressed sound, as well as retain more of the attack and level of the original sound. Conversely, a compressor with soft-knee characteristics will begin compressing the signal lightly before it has actually exceeded threshold and then apply full compression once the signal does exceed threshold. This can generate smoother, more musical compression for applications that require a smooth sound, rather than an aggressively compressed sound.

The OVER EASY parameter in the VENU360’s Compressor module varies the knee characteristics of the compressor. When set to OFF, the compressor will function as a hard-knee compressor, making it sound more aggressive as described above. Setting this parameter to a setting between 1-10 will cause the compressor to act as a soft-knee compressor, yielding more gradual, smooth, and natural compression. The OVER EASY parameter’s 1-10 range is referred to as VariKnee™. Lower values provide a slightly softer knee than a hard-knee compressor. As you increase the OVER EASY setting, the knee softens, rounding out the sound. This lets you choose the exact knee that is needed for the dynamic effect you are looking for.

Generally, a hard-knee compressor will sound louder, more aggressive, and more audible when compressing. The softer the knee, the smoother and less noticeable the compression will be. Use proper judgement, depending upon the application and/or genre of music being reproduced through the sound system and experiment to find the best setting that works for your application.

- **AUTO [OFF, ON]**

Turns Auto mode on and off. When turned off, attack, hold, and release times will be determined by the ATTACK, HOLD, and RELEASE parameters. When turned on, attack, hold, and release times will be program-dependent, meaning they will adjust automatically and dynamically based on input signal characteristics. Note that when AUTO is on, manual ATTACK, HOLD, and RELEASE settings will be ignored.

- **ATTACK [100 μ s - 200ms]**

Sets the speed at which the compressor starts to reduce the signal level once it has exceeded threshold. When AUTO is on, this parameter is ignored and set dynamically.

- **HOLD [0s - 500ms]**

Sets a timer which starts when the signal falls back below threshold and, once the time has elapsed, allows the compressor to release, thereby preventing the compressor from releasing prematurely. When AUTO is on, this parameter is ignored and set dynamically.

- **RELEASE [360dB/s - 5dB/s]**

Sets the rate at which the compressor will come out of gain reduction once the signal level drops back below threshold and the hold time has elapsed. The release time is measured in dB per second. For example, if RELEASE is set to 5 dB/Sec, and the signal has 10dB of gain reduction, the release time is 2 Seconds. The release range is from 360 dB/Sec to 5 dB/Sec. When AUTO is on, this parameter is ignored and set dynamically.

Graphic EQ (GEQ) Module

The 31-band Graphic EQ module can be used to adjust the sound system's frequency response and is available for those who prefer to use this time-tested tool for system EQ. Manually edit the GEQ bands or select one of the "Quick Curves" options to get you started.

GEQ modules can be inserted in the input processing insert slots, see **'Configuring Processing Module Insert Types'** on page 30 for more information on configuring inserts. The following section provides a description of each of the GEQ module parameters and how to edit them.

To edit a GEQ module:

1. Press the EDIT button.

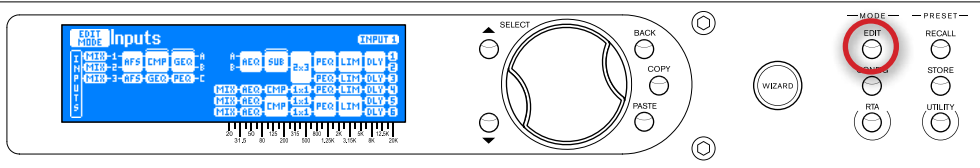

2. Select a GEQ module using the SELECT wheel and UP/DOWN buttons. Press the SELECT wheel to enter the module's menu.

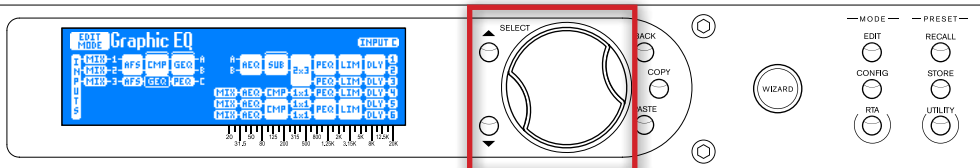

3. Use the SELECT wheel and UP/DOWN buttons to navigate the menu and edit parameters.

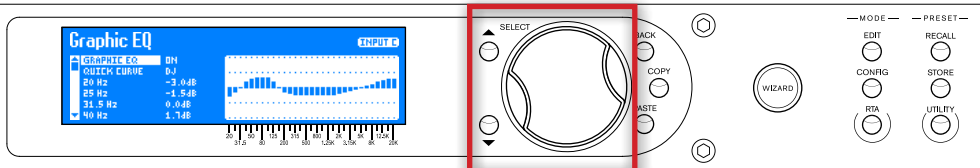

TIP: When in a menu, pressing and holding the **EDIT** button for approximately 2 seconds will advance to the next module below in the configuration map, wrapping around through the available modules. This allows quick navigation between menus of a column and improves efficiency when performing repetitive tasks within like modules.

GEQ Parameters

- **GRAPHIC EQ [OFF, ON]**

Turns the GEQ module on and off.

- **QUICK CURVE [MANUAL, FLAT, MY BAND, SPEECH, VENUE, DJ]**

This parameter allows you to select from pre-set EQ curves. Note that you can select one of these Quick Curves and then further edit the individual GEQ bands manually from there if required. The following Quick Curve options are available:

MANUAL (Restore)

This option is used for getting back to your original GEQ settings in the event that you change the Quick Curve option. For example, if you've already configured the GEQ and you then select the FLAT Quick Curve option, the GEQ will be flattened (all bands set to 0 dB). By then selecting the MANUAL Quick Curve option, the GEQ settings you had prior to selecting the FLAT option will be restored. Note that previous settings cannot be restored after a power cycle or after recalling a different preset.

FLAT

Select this option to reset all GEQ bands to 0 dB (flat).

MYBAND

This option is optimized for live music performance using a portable PA system in small to medium-sized venues (small coffee shops or clubs for example). It offers some low-end boost with low-mid cut, which enhances the low end while preventing the system from sounding too muddy. The high end is slightly attenuated to remove any harshness and further help optimize gain before feedback.

SPEECH

This option is optimized for speech sound reinforcement. Use it to enhance the intelligibility of speech for spoken word applications.

VENUE

This option is optimized for live music performance using larger PA systems in larger-sized venues. This EQ curve is very similar to the MYBAND option except that it does not attenuate the low mids and offers additional attenuation on the highest frequencies.

DJ

Selecting this option will boost the low and high frequencies and attenuate the mid frequencies and is optimized for playback of pre-recorded material. This setting represents the popular "smiley-face" EQ curve commonly used by DJs for a brighter top end and more pronounced bass response.

- **FREQUENCY [-12dB - +12dB]**

There are 31 Frequency parameters available for editing. These parameters allow you to select any one of the 31 available frequency bands (ranging from 20Hz - 20kHz) for editing their gain. The gain of each frequency band can be adjusted in .1 dB increments.

Noise Gate (GAT) Module

The Noise Gate module is used to remove unwanted low-level noise in a sound system. A noise gate will “close” when an insufficient signal level is present (signal level is below threshold) and “open” when a sufficient signal level is present (signal level exceeds threshold). Signal is only allowed to pass in the “open” state.

The Gate in the VENU360 can also function as an expander, meaning you can variably set how much attenuation will occur when the gate is closed, rather than a strict “open” and “closed” (“all” or “nothing”) approach. This allows noise to be attenuated just enough to no longer be a nuisance, thereby minimizing the level difference between the gate “open” and “closed” states and making the gate sound more natural.

Gate modules can be inserted in either the input or mid processing insert slots, see **‘Configuring Processing Module Insert Types’ on page 30** for more information on configuring inserts. The following section provides a description of each of the Gate module parameters and how to edit them.

To edit a Gate module:

1. Press the EDIT button.

2. Select a Gate module using the SELECT wheel and UP/DOWN buttons. Press the SELECT wheel to enter the module’s menu.

3. Use the SELECT wheel and UP/DOWN buttons to navigate the menu and edit parameters.

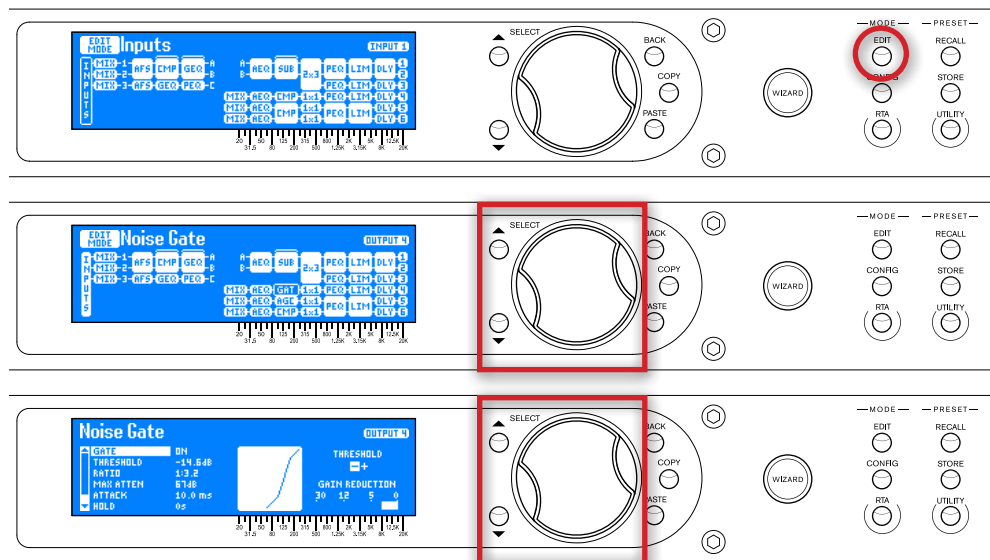

TIP: When in a menu, pressing and holding the **EDIT** button for approximately 2 seconds will advance to the next module below in the configuration map, wrapping around through the available modules. This allows quick navigation between menus of a column and improves efficiency when performing repetitive tasks within like modules.



Gate Parameters

- **GATE [OFF, ON]**

This parameter turns the Gate module on and off.

- **THRESHOLD [-70dB to 0dB]**

Sets the level at which the gate will open. For example, if the THRESHOLD parameter is set to -40 dB, any signal which exceeds -40 dB will open the gate. Any signal lower than -40 dB will be attenuated by the amount determined by the RATIO and MAX ATTEN settings.

The Gate Threshold Indicator (shown to the right) indicates when signal is below threshold or above threshold. Set the THRESHOLD parameter so that the  indicator lights when system signal is not present and the  indicator lights when system signal is present. Avoid setting the THRESHOLD too high as it can cause signal tails and fade-outs to be abruptly cut off as the gate closes. Increasing the HOLD and/or RELEASE parameters can also help reduce these artifacts.

THRESHOLD INDICATOR



Signal Below Threshold
(Gate Closed)



Signal Above Threshold
(Gate Open)

- **RATIO [1:1 - 1:15]**

Determines how much the signal will be attenuated once it drops below threshold. This control works opposite from that of the compressor or limiter ratio control. If a RATIO of 1:4 is selected, a signal that is 1dB below threshold will be reduced in gain so that it becomes 4dB below the threshold.

- **MAX ATTEN [0dB - INF]**

Sets the maximum amount of attenuation that will be applied by the gate. The range of this control is variable between 0 dB - Infinity. 0 dB attenuation means that even though the gate is "closed" there is no gain reduction. Infinity (INF) applies an infinite amount of gain reduction, resulting in no output when the gate is closed.

- **ATTACK [100µs - 200ms]**

Sets the speed at which the gate opens once threshold has been exceeded. It is typical for very fast attack times to be used to catch the fronts of transient signals.

- **HOLD [0s - 500ms]**

Sets the amount of time the gate is held open after the signal falls below threshold.

- **RELEASE [360dB/s - 5dB/s]**

Sets the rate at which the gate "closes" or attenuates the signal once the end of the HOLD time is reached.

Parametric EQ (PEQ) Modules

There are two types of PEQ modules available in the VENU360: 12-band input PEQs and 8-band output PEQs. The 8-band output PEQs are intended to be used for speaker tuning EQ. The 12-band input PEQs can be configured in one of the input processing module insert slots and used for system EQ tasks, see **'Configuring Processing Module Insert Types'** on **page 30** for more information on configuring inserts. The input 12-band PEQs are identical to the output 8-band PEQs with the exception that they support more bands and narrower "Q" settings of up to 128 for applications requiring system-wide notch filtering.

In a perfect world, your loudspeaker drivers would exhibit ultra-flat frequency response (what you put in, you get out). Unfortunately, loudspeaker drivers don't typically have extremely flat frequency response by design and require some help to achieve a more flat frequency response. The output PEQs allow you to compensate for this and improve the frequency response of the loudspeaker system, before taking the room into account.

When you select your main and sub speakers in the Setup Wizard, the output PEQs will automatically be adjusted. By applying speaker tuning EQ, loudspeaker frequency response can be improved. These output PEQs can also be adjusted, so you can manually enter speaker tuning parameters if your speakers aren't listed in the Setup Wizard but speaker tuning data sheets are available, see **'About Speaker & Amplifier Tunings'** on **page 49** for more information.

The following section provides a description of each of the PEQ module parameters and how to edit them.

To edit a PEQ module:

1. Press the **EDIT** button.

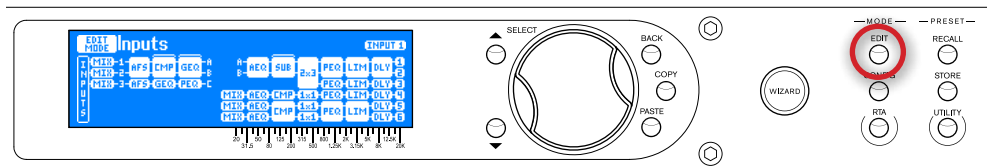

2. Select a PEQ module using the **SELECT** wheel and **UP/DOWN** buttons. Press the **SELECT** wheel to enter the module's menu.

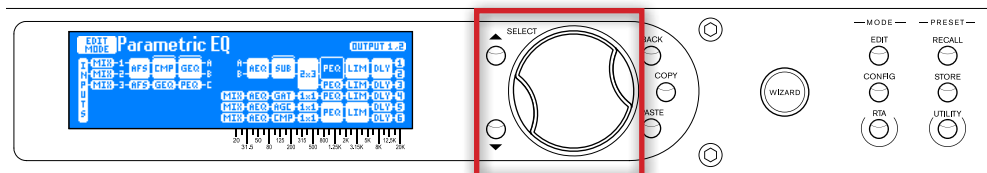

3. Use the **SELECT** wheel and **UP/DOWN** buttons to navigate the menu and edit parameters.

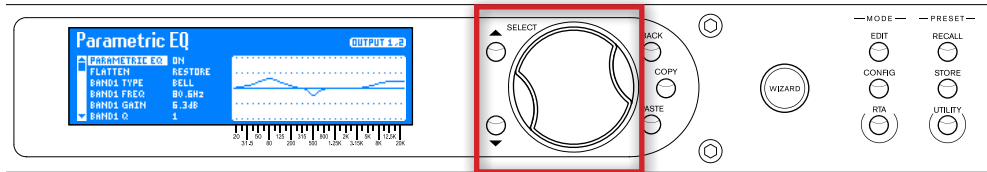

TIP: When in a menu, pressing and holding the **EDIT** button for approximately 2 seconds will advance to the next module below in the configuration map, wrapping around through the available modules. This allows quick navigation between menus of a column and improves efficiency when performing repetitive tasks within like modules.

PEQ Parameters

- **PARAMETRIC EQ [OFF, ON]**

Turns the selected PEQ module on and off.

- **FLATTEN [RESTORE, FLAT]**

Select the FLAT option to zero out the selected PEQ (set all bands to 0 dB). Select the RESTORE option to retrieve the settings you had before you selected the FLAT option. Note that you can only restore PEQ settings as long as you do not power cycle the VENU360 or load another preset.

- **BAND(1-12) TYPE [BELL, LOW SHELF, HIGH SHELF]**

Selects the parametric EQ filter type. Use the BELL type to edit a range of frequencies, the LOW SHELF type to edit all frequencies below a specified frequency, or the HIGH SHELF type to edit all frequencies above a specified frequency. Each band allows you to select between these three band types, so any band can be a bell or shelving type filter.

- **BAND(1-12) FREQUENCY [20Hz - 20kHz]**

Adjusts the center/cutoff frequency of the selected EQ band.

- **BAND(1-12) GAIN [-20dB - +20dB]**

Adjusts the gain of the selected EQ band.

- **BAND(1-12) Q [0.1 - 128]**

This parameter is only available with BELL type filters and adjusts the width of the selected filter. Lower Q settings provide wider filters, affecting a wider range of frequencies when adjusted. Higher Q settings provide narrower filters, which affect fewer frequencies when adjusted. The output PEQs provide Q settings of up to 16, while the input PEQs provide additional selections of 32, 64, and 128 for applications requiring manual notch filtering capabilities.

- **BAND(1-12) SLOPE [3 - 15]**

This parameter is only available with LOW SHELF or HIGH SHELF type filters and adjusts the slope rate of the filter beyond the cutoff frequency. Lower settings yield a more gradual slope. Higher settings produce a steeper slope. The range of the SLOPE parameter is from 3dB/Octave-15dB/Octave.

AutoEQ (AEQ) Module

The AEQ modules are 14-band parametric EQs which reside in the mid processing section of the VENU360 (pre crossover). These modules are automatically adjusted by the built-in AutoEQ Wizard. When running the AutoEQ Wizard, the first 10 AEQ bands will be set. The remaining 4 bands (11-14) are “user” bands and allow you to add to the AutoEQ’ed response without affecting the 10 bands set by AutoEQ. Note that “user” bands 11-14 will not be reset if you run AutoEQ again. If you wish to remove these “user” band settings, you should “Flatten” the AEQ before re-running AutoEQ. AEQ bands, like input PEQ bands, support narrower “Q” settings of up to 128, for applications requiring system-wide notch filtering.

TIP: Using the AutoEQ “user” bands (11-14) to tailor the AutoEQ response to your liking allows the settings to be retained even after subsequent runs of the AutoEQ Wizard. This means that each time you run the AutoEQ Wizard, your manual “user” adjustments will automatically be applied on top of the AutoEQ’ed response curve. If you decide to manually adjust AutoEQ bands 1-10, such manual settings will be wiped out each time the AutoEQ Wizard is run.

AutoEQ modules are fixed pre crossover. The following section provides a description of each of the AEQ module parameters and how to edit them.

To edit an AEQ module:

1. Press the EDIT button.

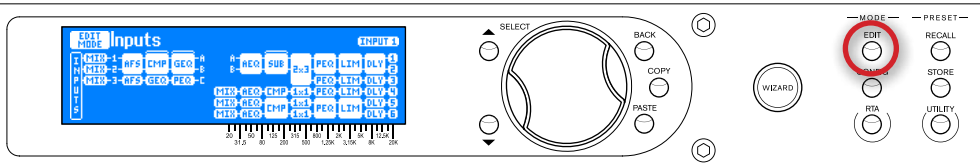

2. Select an AutoEQ module using the SELECT wheel and UP/DOWN buttons. Press the SELECT wheel to enter the module’s menu.

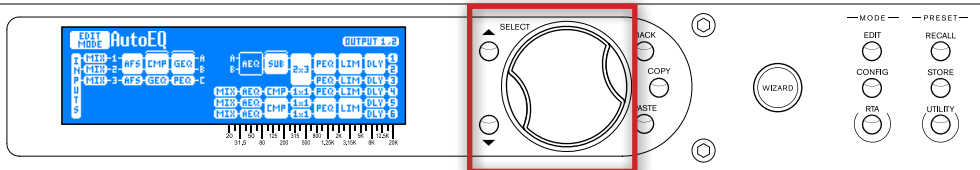

3. Use the SELECT wheel and UP/DOWN buttons to navigate the menu and edit parameters.

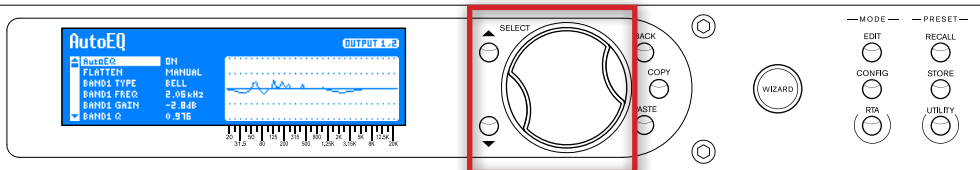

TIP: When in a menu, pressing and holding the **EDIT** button for approximately 2 seconds will advance to the next module below in the configuration map, wrapping around through the available modules. This allows quick navigation between menus of a column and improves efficiency when performing repetitive tasks within like modules.

AEQ Parameters

- **AutoEQ [OFF, ON]**

Turns the selected AEQ module on and off.

- **FLATTEN [FLAT, MANUAL, AUTOEQ]**

Select the FLAT option to zero out the AEQ (set all bands to 0 dB). If any manual changes are made to AEQ settings, the MANUAL option will automatically be selected to indicate this. If the AutoEQ Wizard was run and any manual changes were made to bands 1-10, selecting the AUTOEQ option will revert these bands back to the settings that were set by the AutoEQ Wizard (“user” bands 11-14 will not be affected when selecting the AUTOEQ option).

- **BAND(1-14) TYPE [BELL, LOW SHELF, HIGH SHELF]**

Selects the parametric EQ filter type. Use the BELL type to edit a range of frequencies, the LOW SHELF type to edit all frequencies below a specified frequency, or the HIGH SHELF type to edit all frequencies above a specified frequency. Each band allows you to select between these three band types, so any band can be a bell or shelving type filter.

- **BAND(1-14) FREQUENCY [20Hz - 20kHz]**

This parameter adjusts the center/cutoff frequency of the selected EQ band.

- **BAND(1-14) GAIN [-20dB - +20dB]**

Adjusts the gain of the selected EQ band.

- **BAND(1-14) Q [0.1 - 128]**

This parameter is only available with BELL type filters and adjusts the width of the selected filter. Lower Q settings provide wider filters, affecting a wider range of frequencies when adjusted. Higher Q settings provide narrower filters, which affect fewer frequencies when adjusted. The AEQs provide Q settings of up to 128 for applications requiring manual notch filtering capabilities.

- **BAND(1-14) SLOPE [3 - 15]**

This parameter is only available with LOW SHELF or HIGH SHELF type filters and adjusts the slope rate of the filter beyond the cutoff frequency. Lower settings yield a more gradual slope. Higher settings produce a steeper slope. The range of the SLOPE parameter is from 3dB/Octave-15dB/Octave.

Subharmonic Synth (SUB) Module

dbx's subharmonic synthesis (or sub-synth) processing has been specifically optimized to enhance the low frequencies in audio material and was designed for use in a variety of professional audio applications, including nightclub and dance DJ mixing, theatre and film sound, music recording, live music performance, and broadcasting. Using traditional EQ to enhance this extremely low frequency region can increase noise potential and stage rumble (low-frequency feedback) in live PA systems. Another problem is that the audio source may not have sufficient low end in this region to boost or the mic used to capture the sound may not capture these extremely low frequencies.

Subharmonic synthesis creates synthesized low frequencies based on some of the higher frequencies in the audio program (around 100Hz) and gives you noise free low-end enhancement. The LEVEL control sets the overall amount of processing applied and the two separate bands of subharmonic synthesis level provide additional control for creating a deep, smooth low-end response.

The level meters available in the Subharmonic Synth menu show overall effect level, 35-56 Hz effect level, and 24-36 Hz effect level. Use these meters while adjusting the Subharmonic Synthesizer's parameters to see how much of the effect you are adding to the mix.



Subharmonic Synthesis Level Meters

When using an aux-fed subwoofer configuration, the VENU360 allows the sub-synth effect to be applied only to the aux-fed-sub processing chain, completely eliminating processing artifacts on other instruments and vocals. See **'Application 3: Bi-Amplified Mains + Aux-Fed Subs'** on page 101 for more information on using aux-fed subwoofer configurations.

Subharmonic Synth modules can be inserted in either the input or mid processing insert slots, see **'Configuring Processing Module Insert Types'** on page 30 for more information on configuring inserts. The following section provides a description of each of the Subharmonic Synth module parameters and how to edit them.

To edit a Subharmonic Synth module:

1. Press the EDIT button.

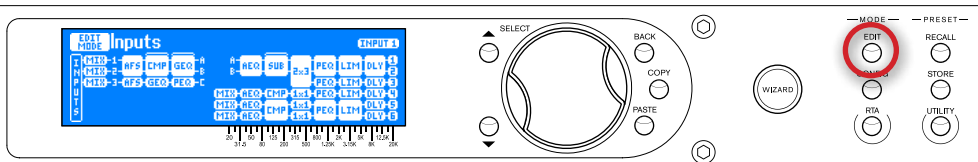

2. Select a Subharmonic Synth module using the SELECT wheel and UP/DOWN buttons. Press the SELECT wheel to enter the module's menu.

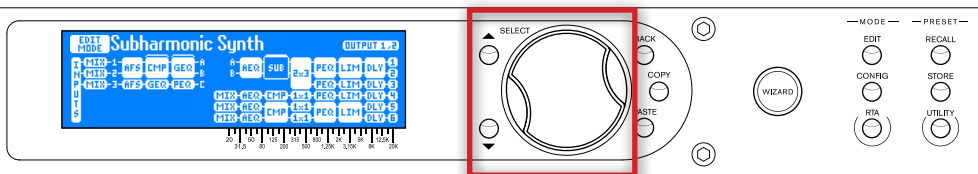

3. Use the SELECT wheel and UP/DOWN buttons to navigate the menu and edit parameters.

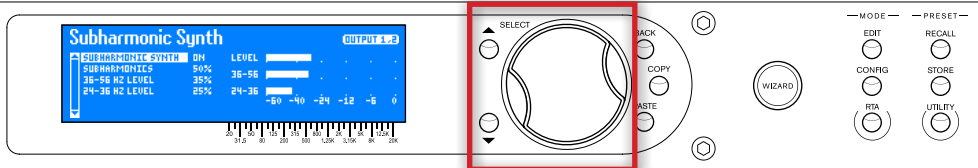

TIP: When in a menu, pressing and holding the **EDIT** button for approximately 2 seconds will advance to the next module below in the configuration map, wrapping around through the available modules. This allows quick navigation between menus of a column and improves efficiency when performing repetitive tasks within like modules.

Subharmonic Synth Parameters

- **SUBHARMONIC SYNTH [OFF, ON]**

Turns the Subharmonic Synth module on and off.

- **SUBHARMONICS [0% - 100%]**

Sets the overall level of the sub-synth effect.

- **36-56 HZ LEVEL [0% - 100%]**

Adjusts how much of the sub-synth effect is added between the 36 Hz to 56 Hz region. If the sound becomes too “woofy” or “growly”, try turning this parameter down. You may find that a certain setting produces fine results in one room, but produces too much “boominess” in another. If this occurs, adjust the parameter as needed.

- **24-36 HZ LEVEL [0% - 100%]**

Adjusts how much of the sub-synth effect is added between the 24 Hz to 36 Hz region. If your woofers are bottoming out (making a ticking or popping sound), turn this parameter down. Enhance this frequency region less than the 36-56 Hz region (as shown in the level meter screenshot on the previous page) for more natural bass roll-off. Experimentation will pay off with smooth, full, deeply extended bass.

IMPORTANT! The subharmonic synthesis process produces low-frequency audio signals that some speakers may not be designed to reproduce. Attempting to achieve enhanced bottom end with these systems may not be possible and may result in over-stressing or even damaging your loudspeakers. It is generally not a good idea to use this feature without a subwoofer. In any case, please refer to your speakers' frequency response specification, and avoid forcing them to reproduce low frequencies that they are not designed to reproduce.

TIP: If you experience low-frequency artifacts on a voice when using subharmonic synthesis, try engaging a high-pass filter on the mixer's vocal channel, adjusting the vocal channel's EQ, or a combination thereof to reduce the artifacts. If a high-pass filter and EQ are not enough, try lowering the overall amount of Subharmonic Synthesis applied to the signal by adjusting the SUBHARMONICS parameter. Such artifacts can be completely eliminated by using an aux-fed sub configuration and processing the aux-fed-sub chain independently with subharmonic synthesis. For more information on aux-fed sub configurations, see **'Application 3: Bi-Amplified Mains + Aux-Fed Subs' on page 101.**

Crossover Module

A crossover is used to divide the broadband signal into separate frequency bands. This allows each loudspeaker or driver in a sound system to operate within its optimal frequency range. Using an active crossover, like that in the VENU360, has the additional benefits of increasing the efficiency of your power amplifiers, lowering intermodulation distortion, and in some cases, improving the drivers' transient response.

The Crossover module in the VENU360 can be configured for full range up to mono 6-way operation. All outputs provide a band-pass filter (a combination of high-pass and low-pass filters) with selectable filter types and slope rates – ranging from 6 dB/octave to 48 dB/octave.

When you select your speakers in the Setup Wizard, the VENU360 will automatically configure the crossover for your system. If tunings aren't listed for your speakers, check the ever-growing online database using the VENU360 control app to see if they've been added. If tunings cannot be found for your speakers, selecting the "Not Listed??" option for any such components will set safe and usable crossover settings. These settings may work perfectly fine for you, but if you would like to dig your heels in, know that you can likely improve system performance by fine-tuning the crossover parameters. See **'Manually Optimizing A System Using The VENU360' on page 49** for more information.

Different Crossover types can be configured in Configuration mode, see **'Configuring Crossover Types' on page 32** for more information on configuring Crossovers and to see the available Crossover types. The following section provides a description of each of the Crossover module parameters and how to edit them.

To edit a Crossover module:

1. Press the EDIT button.

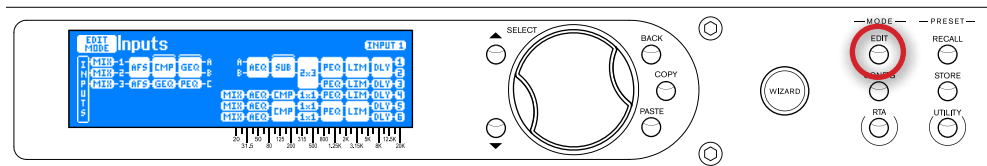

2. Select a Crossover module using the SELECT wheel and UP/DOWN buttons. Press the SELECT wheel to enter the module's menu.

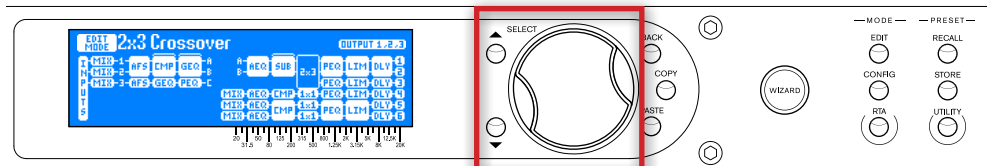

3. Use the SELECT wheel and UP/DOWN buttons to navigate the menu and edit parameters.

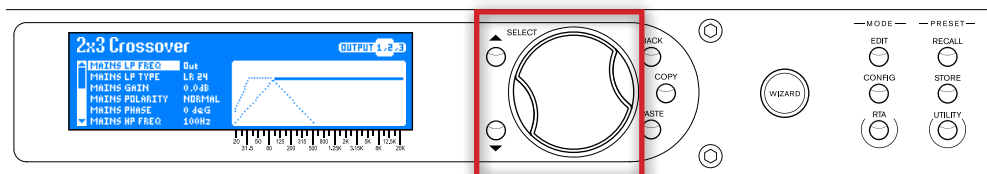

TIP: When in a menu, pressing and holding the **EDIT** button for approximately 2 seconds will advance to the next module below in the configuration map, wrapping around through the available modules. This allows quick navigation between menus of a column and improves efficiency when performing repetitive tasks within like modules.

Crossover Parameters

- **“BAND NAME” LP FREQUENCY [16 Hz - 20 kHz, OUT]**
Adjusts the cutoff frequency of the low-pass filter.
- **“BAND NAME” LP TYPE [BW 6, BW 12, BW 18, BW 24, BW 30, BW 36, BW 42, BW 48, LR 12, LR 24, LR 36, LR 48]**
Selects the low-pass filter type and slope rate. BW stands for Butterworth. When two Butterworth filters are summed, a 3 dB increase in level will be created at the crossover frequency. LR stands for Linkwitz-Riley. When two Linkwitz-Riley filters are summed, there is no increase in level around the crossover frequency, which makes these type of filters very popular. The numbers next to each option represent the filter slope rate in decibels per octave.
- **“BAND NAME” GAIN [-60 dB to +20 dB]**
Adjusts the output gain for the selected band.
- **“BAND NAME” POLARITY [NORMAL, INVERTED]**
Inverts the polarity of the selected band. Polarity inversion is used to match driver polarity in systems which require it. See **‘Manually Optimizing A System Using The VENU360’ on page 49** for more information on polarity inversion.
- **“BAND NAME” PHASE [-180 deg - 0 deg]**
This parameter utilizes an all-pass filter to adjust the phase of the signal at the LPF filter frequency by the number of degrees indicated. This parameter only needs to be adjusted when utilizing bands containing both a high and low-pass filter, such as a mid band in a 3-way crossover, or when a high-pass filter is engaged on a subwoofer crossover band to filter out subsonic frequencies. This adjustment is useful for correcting the positive phase shift caused by the band’s high-pass filter and allows the phase of the signal to be realigned at the crossover point (the low-pass filter frequency). Correcting for this phase anomaly will improve coherence within the crossover overlap regions. See **‘Manually Optimizing A System Using The VENU360’ on page 49** for more information on using this parameter.
- **“BAND NAME” HP FREQUENCY [OUT, 16 Hz - 20 kHz]**
Adjusts the cutoff frequency of the high-pass filter.
- **“BAND NAME” HP TYPE [BW 6, BW 12, BW 18, BW 24, BW 30, BW 36, BW 42, BW 48, LR 12, LR 24, LR 36, LR 48]**
Selects the high-pass filter type and slope rate. BW stands for Butterworth. When two Butterworth filters are summed, a 3 dB increase in level will be created at the crossover frequency. LR stands for Linkwitz-Riley. When two Linkwitz-Riley filters are summed, there is no increase in level around the crossover frequency, which makes these type of filters very popular. The numbers next to each option represent the filter slope rate in decibels per octave.

Limiters (LIM) Module

Limiters are used to set a ceiling on the signal level, preventing the signal from exceeding a predetermined threshold. For this reason, they are used to prevent the overdriving of equipment. Limiters are compressors with high ratios (typically, a ratio of around 10:1 or higher is generally considered limiting). The ratio settings in the VENU360 Limiter modules are fixed at infinity:1, meaning they provide a “rigid ceiling” or “hard limiting”. In live PA sound systems, limiters can be used just before the amplifiers to squeeze the last bit of level out of the system and protect the loudspeakers by preventing the amplifiers from clipping.

The Limiter modules in the VENU360 are post crossover, meaning they can function as band-limited limiters. This allows for independent limiting of multi-way system drivers. For example, you could apply limiting on the signal feeding the subwoofer amplifier without affecting any of the higher frequencies being sent to the main speakers. This has the additional benefit of making any such limiting less noticeable.

The Limiter thresholds will automatically be set for you when you run the Setup Wizard and select your amplifiers from the tuning list. If tunings aren't listed for your amplifiers, check the ever-growing online database using the VENU360 control app to see if they've been added. If tunings cannot be found for your amps, select the “Not Listed??” option. Note that the Limiters will not be set for your amps when selecting the “Not Listed??” option. Therefore, the Limiters will need to be calibrated manually if you wish to use them to protect the system. See **‘Manually Optimizing A System Using The VENU360’ on page 49** for more information on manually calibrating the Limiters.

Limiter modules are fixed in the output processing stage. The following section provides a description of each of the Limiter module parameters and how to edit them.

To edit a Limiter module:

1. Press the **EDIT** button.

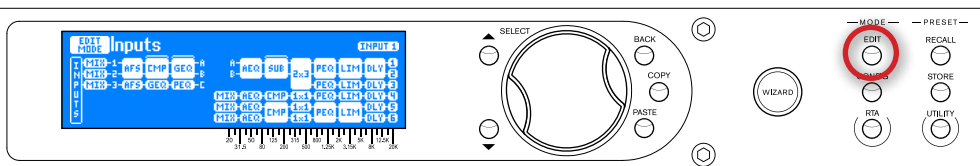

2. Select a Limiter module using the **SELECT** wheel and **UP/DOWN** buttons. Press the **SELECT** wheel to enter the module's menu.

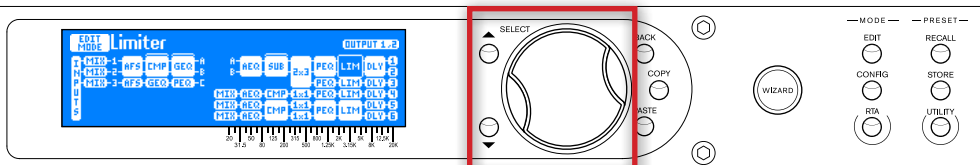

3. Use the **SELECT** wheel and **UP/DOWN** buttons to navigate the menu and edit parameters.

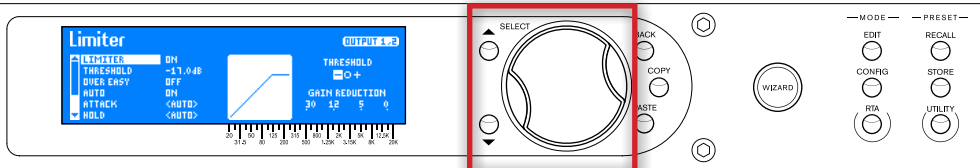

TIP: When in a menu, pressing and holding the **EDIT** button for approximately 2 seconds will advance to the next module below in the configuration map, wrapping around through the available modules. This allows quick navigation between menus of a column and improves efficiency when performing repetitive tasks within like modules.

Limiter Parameters

- **LIMITER [OFF, ON]**

Turns the selected Limiter module on and off.

- **THRESHOLD [-60 dB to 0 dB]**

Sets the level at which the limiter will begin limiting the signal. The Limiter Threshold Indicators (shown to the right) indicate when signal is below threshold, above threshold, or in the OverEasy region.

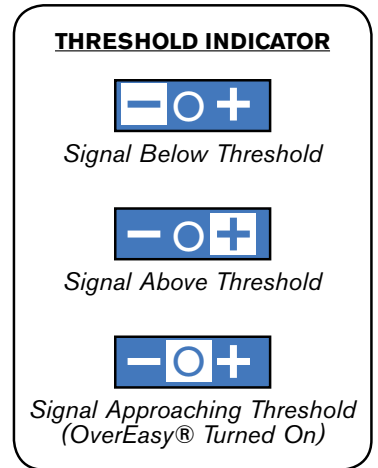

- **OVER EASY [OFF, 1-10]**

One criterion that determines how a limiter will function is called the “knee”. The knee region exists at or around the limiter’s threshold setting and determines how gradual or abrupt the limiting will be. A limiter with hard-knee characteristics won’t limit the signal until it exceeds threshold and will provide a more abrupt and aggressively limited sound, as well as retain more of the attack and level of the original sound. Conversely, a limiter with soft-knee characteristics will begin limiting the signal lightly before it has actually exceeded threshold then apply full limiting once the signal does exceed threshold. This can generate smoother, more musical limiting.

The OVER EASY parameter in the VENU360’s Limiter module varies the knee characteristics of the limiter. When set to OFF, the limiter will function as a hard-knee limiter, making it sound more aggressive as described above. Setting this parameter to a setting between 1-10 will cause the limiter to act as a soft-knee limiter, yielding more gradual, smooth, and natural limiting. The OVER EASY parameter’s 1-10 range is referred to as VariKnee™. Lower values provide a slightly softer knee than a hard-knee limiter. As you increase the OVER EASY setting, the knee softens, rounding out the sound. This lets you choose the exact knee that is needed for the dynamic effect you are looking for.

Generally, a hard-knee limiter will sound louder, more aggressive, and more audible when limiting – although when the VENU360 is configured for 2-way or 3-way operation, the output limiters become “band-limited”, making these artifacts less audible. The softer the knee, the lower in level the source will sound, but the smoother and less noticeable the limiting will be. Use proper judgement, depending upon the application and/or genre of music being reproduced through the sound system, and experiment to find the best setting that works for your application.

- **AUTO [OFF, ON]**

Turns Auto mode on and off. When turned off, attack, hold, and release times will be determined by the ATTACK, HOLD, and RELEASE parameters. When turned on, attack, hold, and release times will be program-dependent, meaning they will adjust automatically and dynamically based on input signal characteristics. Note that when AUTO is on, manual ATTACK, HOLD, and RELEASE settings will be ignored.

- **ATTACK [100µs - 200ms]**

Sets the speed at which the limiter starts to reduce the signal level once it has exceeded threshold. When AUTO is on, this parameter is ignored and set dynamically.

- **HOLD [0s - 500ms]**

Sets a timer which starts when the signal falls back below threshold and, once the time has elapsed, allows the limiter to release, thereby preventing the limiter from releasing prematurely. When AUTO is on, this parameter is ignored and set dynamically.

- **RELEASE [360dB/s - 5dB/s]**

Sets the rate at which the limiter will come out of gain reduction once the signal level drops back below threshold and the hold time has elapsed. Release is measured in dB per second. For example, if RELEASE is set to 5 dB/Sec, and the signal has 10dB of gain reduction, the release time is 2 Seconds. The release range is from 360 dB/Sec to 5 dB/Sec. When AUTO is on, this parameter is ignored and set dynamically.

- **PEAK STOP PLUS [OFF, ON]**

Enables PeakStopPlus™ and changes the limiter from an RMS (Root Mean Squared), or averaging limiter, to a peak limiter. The difference between these two types of limiters is in the signal that is being fed to the detection circuit of the algorithm. The detector of an RMS limiter is “looking” at an average signal, while a peak limiter “looks” at the instantaneous (peak) signal. An averaging limiter will be less responsive and will not actually limit every peak, where a peak limiter will.

PeakStopPlus involves a two-stage process of dynamic limiting. The first stage of PeakStopPlus is the Instantaneous Transient Clamp which clamps the signal with a soft logarithmic clamp function. This logarithmic function ensures that the signal will not exceed the level set by the PeakStopPlus OVERSHOOT control by more than the overshoot amount, and that it will not introduce harsh artifacts. The second stage is a unique program limiter featuring Intelligent Predictive Limiting. Its function is to monitor the input signal and intelligently predict the amount of gain reduction needed to keep the output signal below the ceiling set by the Instantaneous Transient Clamp. The OVERSHOOT parameter sets the amount of overshoot for the Instantaneous Transient Clamp.

- **OVERSHOOT [2dB - 6dB]**

Sets the amount of transient overshoot allowed when PEAK STOP PLUS is turned on. Lowering this parameter will provide additional protection, but may subtly affect the sound as transients become softened.

RTA

The 31-band RTA (Real-Time Analyzer) allows you to monitor the sound system's frequency response. A built-in signal generator is also available in the RTA menu. The signal generator and RTA can be used to manually fine-tune and troubleshoot the system or to help identify system feedback and resonant frequencies. Since the signal generator can be steered to each of the direct inputs, it can also be used to verify signal routing in a preset configuration.

The following section provides a description of each of the RTA parameters and how to edit them.

To access and use the RTA and signal generator:

1. Press the RTA button.

2. Use the SELECT wheel and UP/DOWN buttons to navigate the menu and edit parameters.

The image shows two screenshots of the RTA menu on a control panel. The top screenshot shows the RTA button circled in red. The bottom screenshot shows the SELECT wheel and UP/DOWN buttons circled in red.

RTA Parameters

- RTA SOURCE [RTA MIC, A, B, C, A+B, B+C, A+B+C, 1, 2, 3, 1+2, 2+3, 1+2+3, IN1-IN7, SIGNAL GENERATOR]**
 Selects the source signal to route to the RTA. Signals can be routed from the RTA MIC INPUT jack, the 1/2/3 bus points, the A/B/C bus points, the built-in signal generator, or directly from the inputs. The source selected here will be reflected in the graphic displayed when viewing the RTA home screen (see examples in the following table). See **'The Home Screens'** on page 14 for more information on the RTA home screen.

RTA Source Routing Options

| Description | Routing Diagram | Description | Routing Diagram | Description | Routing Diagram |
|-----------------------|-----------------|--------------------|-----------------|------------------------|-----------------|
| Route RTA MIC | | Route IN7 (*AES 4) | | Route Bus A | |
| Route IN1 (*Analog 1) | | Route Bus 1 | | Route Bus B | |
| Route IN2 (*Analog 2) | | Route Bus 2 | | Route Bus C | |
| Route IN3 (*Analog 3) | | Route Bus 3 | | Route Bus A+B | |
| Route IN4 (*AES 1) | | Route Bus 1+2 | | Route Bus B+C | |
| Route IN5 (*AES 2) | | Route Bus 2+3 | | Route Bus A+B+C | |
| Route IN6 (*AES 3) | | Route Bus 1+2+3 | | Route Signal Generator | |

*Fixed input channel configuration in standard VENU360 model. When using a VENU360-D (Dante) or VENU360-B (BLU link) model, input channel configuration can be modified to include Dante or BLU link channels depending on model. See **'Configuring BLU Link / Dante Inputs'** on page 26 for information on configuring input channels.

- **RATE [SLOW, FAST]**

Adjusts how quickly the RTA will sample the audio and update its display. When set to FAST, instantaneous peaks can be seen, but the RTA will react very quickly, making it difficult to use for some tasks. When set to SLOW, the RTA will update at a slower rate, making it easier to read the amplitude levels of all frequencies.

- **GRAPH OFFSET [0 dB - 40 dB]**

Adjusts the signal level entering the RTA. Adjust this parameter so that the full frequency spectrum of the monitored signal can be displayed within the RTA graph.

- **GRAPH TYPE [OPT1 - OPT6]**

Selects between six different RTA graph view types. Select the type which looks best to you.

- **GRAPH HOLD [0.5s - 5.0s]**

Sets the length of time the RTA will "hold" peaks in the display, providing an easy-to-read visual indication of peak levels, even after they've already passed. Time units are in seconds.

- **SIGNAL GEN [OFF, ON]**

Turns the built-in signal generator on or off. The Signal Generator can be used for signal routing verification, system troubleshooting, or manual system calibration.

NOTE: The Signal Generator will automatically default to off whenever a new configuration is applied, a different preset is loaded, or the Setup Wizard is completed. This is a safety feature to prevent accidental damage to system components.

- **SIGNAL TYPE [PINK, WHITE, SINE]**

There are three signal type options to select from, they are: PINK, WHITE, and SINE. Some analyzers are calibrated to read "flat" across the frequency spectrum when white noise is used, others are calibrated to read flat when pink noise is used, and some allow you to select between the two. The VENU360's built-in RTA is calibrated to read flat when pink noise is used. Selecting the SINE option enables the SINE FREQ parameter, which allows you to select the frequency of the tone being generated.

TIP: Before enabling the Signal Generator and playing sine tones through the system, ensure that any enabled AFS modules are turned off. Failing to do so can cause AFS filters to be set. If this happens when AFS is in Live mode, simply clear the Live filters in the AFS menu. See '**Advanced Feedback Suppression (AFS) Module**' on page 62 for further information on turning AFS modules off and clearing Live filters.

- **SIGNAL ROUTE [IN1-IN7, ALL]**

Selects where to inject the Signal Generator signal. The options are "IN1"- "IN7" or "ALL" (inputs). When the Signal Generator is enabled, the signal will be routed to the selected SIGNAL ROUTE, muting the signal that normally feeds the configured input and replacing it with the Signal Generator's signal. This allows the Signal Generator to be used not only for identifying system issues, but also for verifying signal routing within a loaded preset configuration, by enabling and steering the Signal Generator then looking at the front-panel LED meters to see where each signal is routed.

- **SIGNAL LEVEL [-60dB - 0dB]**

Adjusts the level of the Signal Generator.

- **SINE FREQ [20Hz - 20kHz]**

Adjusts the frequency of the generated tone when SIGNAL GEN is "ON" and the SIGNAL TYPE is set to "SINE".

TIP: When using the RTA from the front panel of the VENU360, you may want to disable the HOME SCREEN TIME OUT feature in the Utility menu to prevent the LCD display from timing out and returning to the home screen. For more information on the HOME SCREEN TIME OUT feature, see '**Utility Menu**' on page 92.

TIP: You can choose to make the RTA your home screen. For more information on changing the home screen, see '**The Home Screens**' on page 14.

Utility Menu

The Utility menu allows you to edit global system parameters and provides VENU360 system information.

To edit Utility parameters:

1. Press the **UTILITY** button.

2. Use the **SELECT** wheel and **UP/DOWN** buttons to navigate the menus and edit parameters.

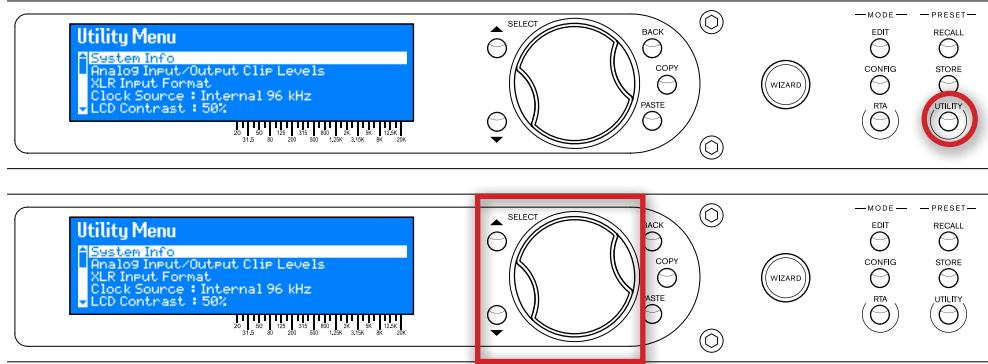

Utility Parameters

- **SYSTEM INFO**

Selecting this option displays important VENU360 system information, such as the currently installed firmware version, network IP address, and MAC address. You can also view some of this system information via the System Info home screen. See **'The Home Screens' on page 14** for more information on the System Info home screen.

- **BLU LINK**

The BLU link menu is only available in the VENU360-B model and includes the following submenus:

BLU LINK INFO

This submenu displays the BLU link protocol version, the BLU link ports' MAC address, and the MAC address and priority setting of the BLU link device providing master clock for the BLU link ring.

BLU LINK SETUP

This submenu allows you to configure the internal BLU link card's Sample Rate and Priority settings. The Sample Rate setting must be set to match the sample rate of all other devices on the BLU link ring. The Priority setting determines which BLU link device on the ring will provide master clock and can be set to any value between 0 and 254, with 0 being the lowest priority and 254 being the highest. The BLU link device on the BLU link ring with the highest priority setting will be the master for all other BLU link devices on the ring. See **'Configuring Inputs, Master Clock Source, & SRC' on page 20** for more information on configuring the BLU link Sample Rate and Priority settings.

BLU LINK INPUT NAMES

In this submenu, you can edit BLU link input channel names using the **SELECT** wheel. These input names can also be edited by running the BLU link Setup Wizard. For faster naming, a default input name list is also provided.

BLU LINK INPUT CHANNELS

This submenu allows you to assign BLU link (off-ramp) channels to the VENU360-B's inputs. These input channel assignments can also be configured by running the BLU link Setup Wizard, see **'Using The Wizards (Wizard Mode)' on page 17** for more information. Assigning BLU link input channels is the first step in configuring BLU link inputs. The second step involves configuring the BLU link inputs in the preset, see **'Configuring BLU Link / Dante Inputs' on page 26** for more information on configuring BLU link inputs.

BLU LINK OUTPUT CHANNELS

This submenu allows you to configure which BLU link (on-ramp) channels the VENU360-B's outputs will be assigned to on the BLU link ring. These output channel assignments will mirror the analog XLR outputs and carry the signal post the VENU360-B's output processing chains. These output channel assignments can also be configured by running the BLU link Setup Wizard, see '**Using The Wizards (Wizard Mode)**' on page 17.

NOTE: A device's BLU link input and output channel assignments should be unique. For example, a device should not have BLU link channel 1 assigned to one of its inputs as well as one of its outputs – this could cause the signal to be fed out and back into itself. Also, no two BLU link devices should be assigned with matching BLU link output channels. See '**Application 8: BLU Link Application (VENU360-B)**' on page 106 to see an example of input/output channel assignments in a BLU link system.

BLU LINK INPUT STATUS

This submenu displays the current BLU link input port status and the number of errors and corrected errors detected on the BLU link input port. Under normal operation, the status should read "Connected". If it reads anything other than "Connected", go to Utility > BLU link > BLU link Setup and make sure you have properly configured the BLU link sample rate to match the sample rate of all other BLU link devices on the ring and that you are using straight-through CAT5e or CAT6 Ethernet cables. Pressing the **SELECT** wheel from this submenu will clear all error and corrected error counts.

BLU LINK OUTPUT STATUS

This submenu displays the current BLU link output port status and the number of errors and corrected errors detected on the BLU link output port. Under normal operation, the status should read "Connected". If it reads anything other than "Connected", go to Utility > BLU link > BLU link Setup and make sure you have properly configured the BLU link sample rate to match the sample rate of all other BLU link devices on the ring and that you are using straight-through CAT5e or CAT6 Ethernet cables. Pressing the **SELECT** wheel from this submenu will clear all error and corrected error counts.

- **DANTE**

The Dante menu is only available in the VENU360-D model and includes the following submenus:

DANTE INFO

This submenu displays the Dante card's device name on the Dante network, the Dante port's MAC addresses, and the Dante card's software and firmware versions.

DANTE VERSIONS

This submenu displays versions of the various components that make up the Dante protocol.

DANTE CLOCKING

This submenu displays Dante network settings, such as the Dante network's sample rate, clock source, the MAC address of the device providing master clock, and the clock status of the PRIMARY and SECONDARY Dante ports.

DANTE PRIMARY STATUS

This submenu displays the status of the PRIMARY Dante port.

DANTE PRIMARY INFO

This submenu displays additional information about the PRIMARY Dante connection.

DANTE SECONDARY STATUS

This submenu displays the status of the SECONDARY Dante port.

DANTE SECONDARY INFO

This submenu displays additional information about the SECONDARY Dante connection.

DANTE INPUT CHANNEL NAMES

This submenu displays the names given to the VENU360-D's Dante input channels.

DANTE INPUT CHANNEL STATUS

This submenu displays the status for the VENU360-D's Dante input channels.

DANTE OUTPUT CHANNEL NAMES

This submenu displays the names given to the VENU360-D's Dante output channels.

NOTE: Dante settings cannot be edited in the VENU360-D submenus. These settings must be edited using Audinate's Dante Controller software which is available on Audinate's website.

- **ANALOG INPUT/OUTPUT CLIP LEVELS [INPUTS: +14, +20, +24, +28 dBu / OUTPUTS: +4, +8, +12, +14, +17, +20, +22 dBu]**

Adjust these settings to optimize the analog gain structure between the VENU360 and the connected mixer and amplifiers or powered speakers. This provides optimal analog signal-to-noise performance and device operation. For example, if your mixer outputs a maximum level of 28 dBu, you can set the VENU360's Analog Input Clip Levels to +28 dBu to match. Conversely, if you had your amplifier attenuators maxed out, you could set the Analog Output Clip Levels to around +4 dBu to attenuate the analog output levels and prevent the amplifier from clipping.

WARNING! The Analog Output Clip Levels will be set for you automatically when selecting your amp models in the Setup Wizard. To prevent amplifier clipping and loudspeaker damage, use caution when manually changing these settings. If changing the Analog Output Clip Level settings, it's advisable to drastically lower your mixer output level before doing so and then recalibrate the gain structure and Limiter threshold's before running the system at performance level.

- **XLR INPUT FORMAT [XLR 1/XLR 2 FORMAT: ANALOG, AES 1&2/AES 3&4, SAMPLE RATE CONVERSION: OFF, ON]**

This menu allows you to set the input format for the XLR 1 and XLR 2 input jacks. Each jack can be configured for analog or digital AES connections. Note that 110 ohm balanced cable should be used for AES connections.

When the AES format is selected, sample rate conversion for each XLR jack can also be independently enabled/disabled in this menu. This allows the VENU360 to accommodate connections from multiple clocks or devices operating at sample rates other than 48 or 96 kHz. See '**Configuring Inputs, Master Clock Source, & SRC**' on page 20 for further information on clocking and using sample rate conversion.

- **CLOCK SOURCE [INTERNAL 48 kHz, INTERNAL 96 kHz, AES 1&2, AES 3&4, BLU LINK (VENU360-B model only), DANTE (VENU360-D model only)]**

Selects which clock the VENU360 will sync to and the sample rate of the internal clock. See '**Configuring Inputs, Master Clock Source, & SRC**' on page 20 for further information on clocking.

- **LCD CONTRAST [0% - 100%]**

Adjusts the contrast of the LCD display. Use it to make the LCD display more visible under different lighting conditions.

- **LCD BACKLIGHT [DIM, MEDIUM, BRIGHT]**

Adjusts the brightness of the LCD backlight.

- **HOME SCREEN TIME OUT [10s, 30s, 1min, 2min, 3min, 4min, 5min, 10min, DISABLED]**

Sets the time that it takes for the VENU360 to return to the Home screen after a period of inactivity or disables the Home Screen Time Out feature altogether.

NOTE: Home Screen Time Out will not time out when in certain modes/menus. For instance, it will not time out when in Configuration mode, any of the Wizards, the Preset Recall or Store menus, or the Utility menu. This prevents the accidental loss of changes made by the user, such as when naming a preset.

- **PRESET POWERUP [CURRENT, STORED]**

Determines whether the VENU360 will boot with the settings it had when it was last powered down (CURRENT) or if it will boot and reload the preset as it is stored in memory (STORED).

NOTE: It takes ~5 seconds for a parameter change to be auto-saved when PRESET POWERUP is set to CURRENT. If a parameter is changed and the VENU360 is immediately power cycled before the VENU360 has time to auto-save it, the parameter change will not be retained after a power cycle.

- **MUTES POWERUP [CURRENT, MUTE ALL]**

Determines whether the VENU360 will boot with the output mute settings last used when the device was powered down (CURRENT) or if it will always boot with all outputs muted (MUTE ALL).

- **NETWORK**

Here you can configure DHCP, assign a static IP address, and set subnet mask and gateway settings for communication with the control network. Use the on-screen instructions in each menu to adjust these network settings.

- **APP SECURITY**

Select this option to edit your administrative password. The default password is 'administrator'. Changing the password to anything other than the default password will enable the App Security feature. When enabled, the VENU360 will require a password before it can be controlled over a network using the VENU360 control app. Follow the on-screen instructions to edit the password. Changing the password back to 'administrator' will disable the App Security feature.

- **DEVICE NAME**

Allows you to change the name given to a VENU360 device. This is the name that appears for each VENU360 device when viewed on the network using the VENU360 control app.

- **SALES BANNER [OFF, ON]**

Turns the Sales Banner on or off. The Sales Banner is used for display purposes only.

- **MAP NAVIGATION [HORIZONTAL, VERTICAL]**

Determines whether navigation moves vertically or horizontally when turning the SELECT wheel to navigate the on-screen configuration map for selecting processing modules to edit or configure.

- **PRESET RECALL LIST**

Sets the range of presets accessible from the front panel. By default, the PRESET RECALL LIST is set to allow access to all 100 presets. Turning the SELECT wheel counter-clockwise will narrow the list of presets available for use. Turning the SELECT wheel clockwise will expand the list of presets available for use. For example, if you use only the first 5 presets, you can narrow the list size to the first 5 presets to hide all others. The preset recall list size is selectable from preset 1 up to 25, so when using this feature, make sure the presets you want access to reside in the lowermost numbered preset memory locations. If required, presets at memory locations higher than 25 can be copied to lower memory locations. See '**Managing Presets**' on page 45 for further information on copying presets.

Power-Up Functions

Power-up functions allow you to reset DriveRack VENU360 presets and settings, lock out the front-panel controls, and force the VENU360 to power up with the output mutes enabled. These power-up functions are accessed by pressing and holding certain buttons upon power up. The following section describes the power-up functions available in the VENU360 and how to use them.

Initialize With Mutes On

This power-up function forces the VENU360 to boot up with all outputs initially muted. This will prevent audio from passing through the VENU360's outputs until you're ready to manually unmute the output channels.

To initialize the VENU360 with mutes on:

1. Press and hold any **MUTE** button then power on the VENU360. Keep the button pressed until the LCD display reads, "*MUTE BUTTON HELD All outputs will be muted after initialization.*" then release the **MUTE** button.
2. The VENU360 will now initialize with all outputs muted regardless of the mutes' previous state when the VENU360 was last powered down.

NOTE: The INITIALIZE WITH MUTES ON option is a one-time operation. After performing this power-up function, the VENU360 will revert back to normal operation – meaning the VENU360 will power up with all mutes set to the state they were at when the processor was last powered down. The exception is if you have enabled the MUTES POWERUP option in the Utility menu, in which case the VENU360 will always power up with all output mutes enabled – see '**Utility Menu**' on **page 92** for further information on this feature.

System Lockout

This power-up function locks out the VENU360's front panel controls to prevent unauthorized tampering. The available options are:

- **Unlocked**
This is the default setting and allows access to all VENU360 functions from the front-panel controls.
- **Locked**
When this option is selected, all front-panel controls will be locked and a "LOCKED" message will appear in the LCD display whenever any button is pressed or the SELECT wheel is turned.
- **Locked with AFS Clear**
When this option is selected, all front-panel controls will be locked with the exception of the AFS Filter Clear function. To clear the AFS filters when this option is selected, press the **EDIT** button, select the AFS module to clear using the **SELECT** wheel or **UP/DOWN** buttons, press the **SELECT** wheel to enter the AFS module, then press the **SELECT** wheel one more time to clear the filters.
- **Locked with AFS Clear and Mutes**
This option is similar to the "System Locked with AFS Clear" option listed above. When this option is selected, all front-panel controls will be locked with the exception of the AFS Filter Clear function and output mutes. To clear the AFS filters when this option is selected, press the **EDIT** button, select the AFS module to clear using the **SELECT** wheel or **UP/DOWN** buttons, press the **SELECT** wheel to enter the AFS module, then press the **SELECT** wheel one more time to clear the filters.

TIP: Before enabling any of the above "lockout with AFS clear" options, make sure to enter the AFS modules and set the CLEAR MODE parameters to the desired setting. This will ensure the correct filter types can be cleared once the front panel has been locked. See '**Advanced Feedback Suppression (AFS) Module**' on page 62 for more information on editing the AFS CLEAR MODE parameter.

To change the System Lockout option:

1. Press and hold the **RTA** button then power on the VENU360. Keep the button held until the System Lockout menu prompt appears in the LCD display then release the button.
2. Turn the **SELECT** wheel to highlight the desired option.
3. Press the **SELECT** wheel to select the highlighted option.
4. When prompted, press the **RTA** button to confirm the selection. The VENU360 will boot up and operate according to the System Lockout option selected. Pressing any button other than the **RTA** button will abort the procedure and maintain the setting selected prior to entering the System Lockout menu.

Soft Reset

The Soft Reset function resets all Utility settings in the VENU360 back to their factory default state without resetting user presets.

WARNING! Performing the Soft Reset procedure will reset all analog input and output clip levels, clock source, and XLR input format settings in the Utility menu back to their factory default state. These settings are global but are also important for the correct operation of your presets. It is recommended that you take note of all these settings before performing the Soft Reset procedure. This allows you to easily set them back after the Soft Reset has been performed.

To perform a Soft Reset:

1. Power down the VENU360.
2. Press and hold the **UTILITY** button then apply power to the VENU360. Keep the button held until the “*SOFT RESET Release UTILITY button*” message appears in the LCD display then release the button.
3. Press the **WIZARD** button to perform the Soft Reset procedure. Pressing the **UTILITY** button will cancel the operation.

Factory Reset

The Factory Reset function resets all user presets and Utility settings in the VENU360 back to their factory default state.

WARNING! Performing the Factory Reset procedure will permanently reset all user presets and set all VENU360 settings back to their factory default state. This operation is irreversible.

To perform a Factory Reset:

1. Power down the VENU360.
2. Press and hold the **STORE** button then apply power to the VENU360. Keep the button held until the “*FACTORY RESET Release STORE button*” message appears in the LCD display then release the button.
3. Press the **WIZARD** button to perform the Factory Reset procedure. Pressing the **STORE** button will cancel the operation.

Application Guide

Use these diagrams and notes for reference when initially connecting and configuring the VENU360 for your application.

Application 1: Full Range Mains

This application is suited for full range systems which do not require an active crossover. In this type of configuration, the VENU360 will send full range signal through outputs 1&2. The four remaining available outputs can be configured for zone, delay fill, or stage monitor use if required. Note that a 50Hz high-pass filter is automatically set when configuring a full range crossover in the VENU360. This can help protect full range loudspeakers and improve system headroom since many full range loudspeakers can't reproduce much below this frequency range. This setting can be adjusted in the crossover if desired.

Application Notes:

- Make sure your mixer and amplifiers (or powered speakers) are turned off before making connections.
- Make connections as described in **'Making Connections' on page 4** then apply power to the system according to the instructions described in **'Applying Power' on page 4**.
- Press the **WIZARD** button then run the Setup Wizard and follow the on-screen instructions. Or, if you know your speakers and amps aren't listed in the Setup Wizard, you can simply load preset 76 and start from there.
- Note that some manual configuration changes may be necessary when using the remaining outputs for zone or delay fill use. See **'Using Configuration Mode' on page 24** for further information on making manual configuration changes in the VENU360.

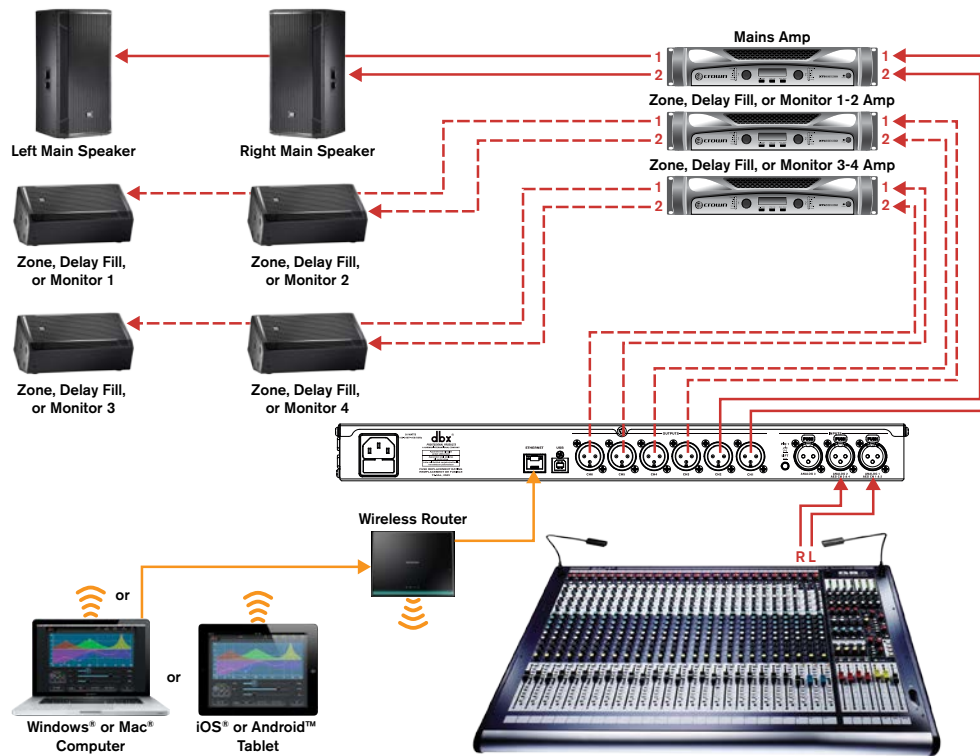

LEGEND

| | | | | |
|-------------------------|---------------------|-------------|-----------------|------------------|
| Analog Audio Connection | Ethernet Connection | 1 Channel 1 | L Left Channel | C Center Channel |
| Optional | Wi-Fi Signal | 2 Channel 2 | R Right Channel | A Aux Channel |

Application 2: Full Range Mains + Subs

This application is suited for use with a system consisting of two full range main speakers and subs. The last two available outputs can be configured for zone, delay fill, or stage monitor use if required.

Application Notes:

- Make sure your mixer and amplifiers (or powered speakers) are turned off before making connections.
- Make connections as described in **'Making Connections'** on page 4 then apply power to the system according to the instructions described in **'Applying Power'** on page 4.
- Press the **WIZARD** button then run the Setup Wizard and follow the on-screen instructions. Or, if you know your speakers and amps aren't listed in the Setup Wizard, you can simply load preset 78 and start from there.
- Note that some manual configuration changes may be necessary when using the remaining outputs for zone or delay fill use. See **'Using Configuration Mode'** on page 24 for further information on making manual configuration changes in the VENU360.

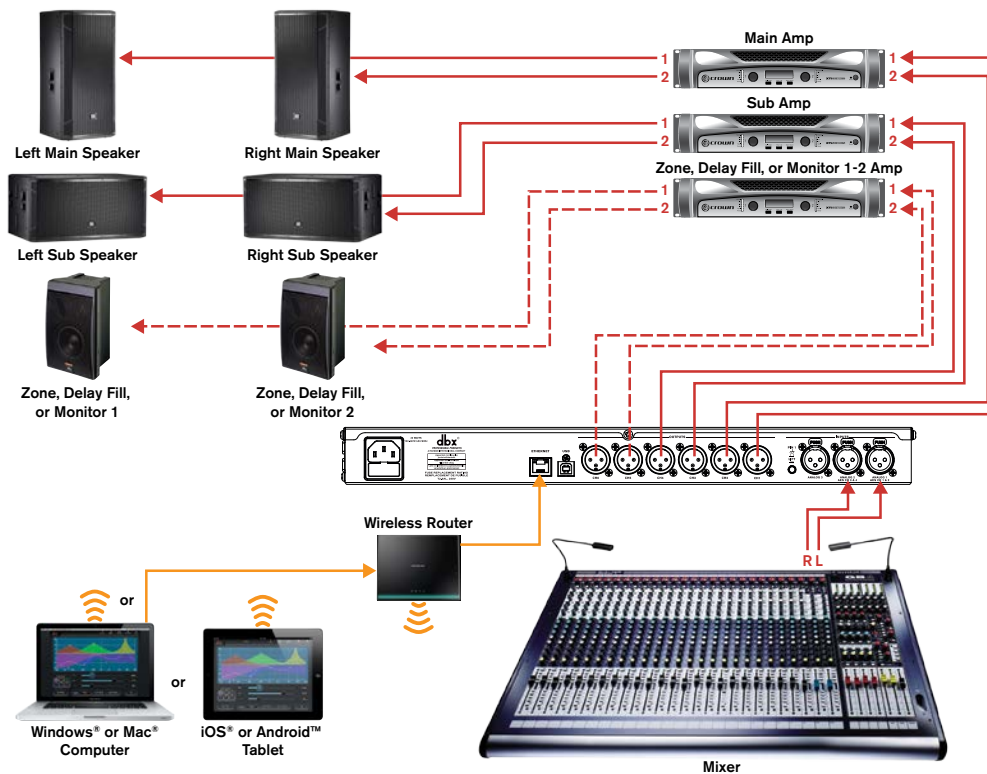

LEGEND

| | | | | |
|-------------------------|---------------------|-------------|-----------------|------------------|
| Analog Audio Connection | Ethernet Connection | 1 Channel 1 | L Left Channel | C Center Channel |
| Optional | Wi-Fi Signal | 2 Channel 2 | R Right Channel | A Aux Channel |

Application 3: Bi-Amplified Mains + Aux-Fed Subs

This application is suited for use with a system consisting of bi-ampable 2-way main speakers and aux-fed subs. If you're not familiar with the term "aux-fed subs", here's a brief explanation. The idea is to use an available post-fade/post-EQ aux send from the mixing console to feed only the channels which contain low-frequency information (e.g., bass guitar, kick drum, floor tom, etc.) to the subs. This is accomplished by simply raising the aux send for each mixer channel you wish to send to the subs, just as you would with stage monitors. Some of the benefits provided by an aux-fed sub configured system are: (a) ultra-clean and tight bass reproduction, beyond what can be accomplished using the mixer's channel high-pass filters alone, (b) significant reduction of low-frequency "stage rumble" and "mud" caused by microphone leakage, and (c) plosive consonants from vocals are no longer reproduced by the subs.

Keep in mind that using an aux-fed sub configuration can complicate other aspects of using the system. For example, the master faders will no longer control the subwoofer levels, so when altering master system level, both the master fader and aux-sub aux send master control will have to be altered equally to maintain the relative levels between the main and sub speakers. Note that care should be taken to prevent such alteration of the relative levels between the subwoofer and main speaker, as this can alter the frequency and phase response of the system.

Application Notes:

- Make sure your mixer and amplifiers (or powered speakers) are turned off before making connections.
- Make connections as described in **'Making Connections' on page 4** then apply power to the system according to the instructions described in **'Applying Power' on page 4**.
- Press the **WIZARD** button then run the Setup Wizard and follow the on-screen instructions. Or, if you know your speakers and amps aren't listed in the Setup Wizard, you can simply load preset 85 and start from there.

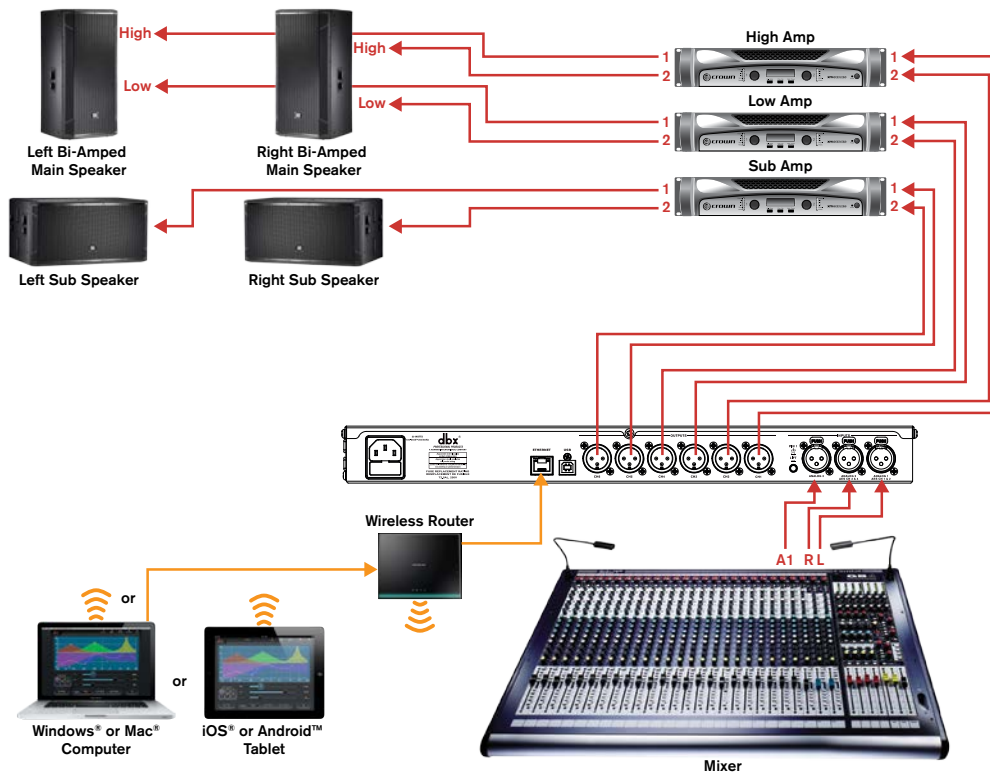

LEGEND

| | | | | |
|-------------------------|---------------------|-------------|-----------------|------------------|
| Analog Audio Connection | Ethernet Connection | 1 Channel 1 | L Left Channel | C Center Channel |
| Optional | Wi-Fi Signal | 2 Channel 2 | R Right Channel | A Aux Channel |

Application 4: LCR Full Range Powered Mains + Subs

This application is suited for use with an LCR system consisting of full range main speakers and subwoofers.

Application Notes:

- Make sure your mixer and amplifiers (or powered speakers) are turned off before making connections.
- Make connections as described in **'Making Connections' on page 4** then apply power to the system according to the instructions described in **'Applying Power' on page 4**.
- Press the **WIZARD** button then run the Setup Wizard and follow the on-screen instructions. Or, if you know your speakers and amps aren't listed in the Setup Wizard, you can simply load preset 97 and start from there.

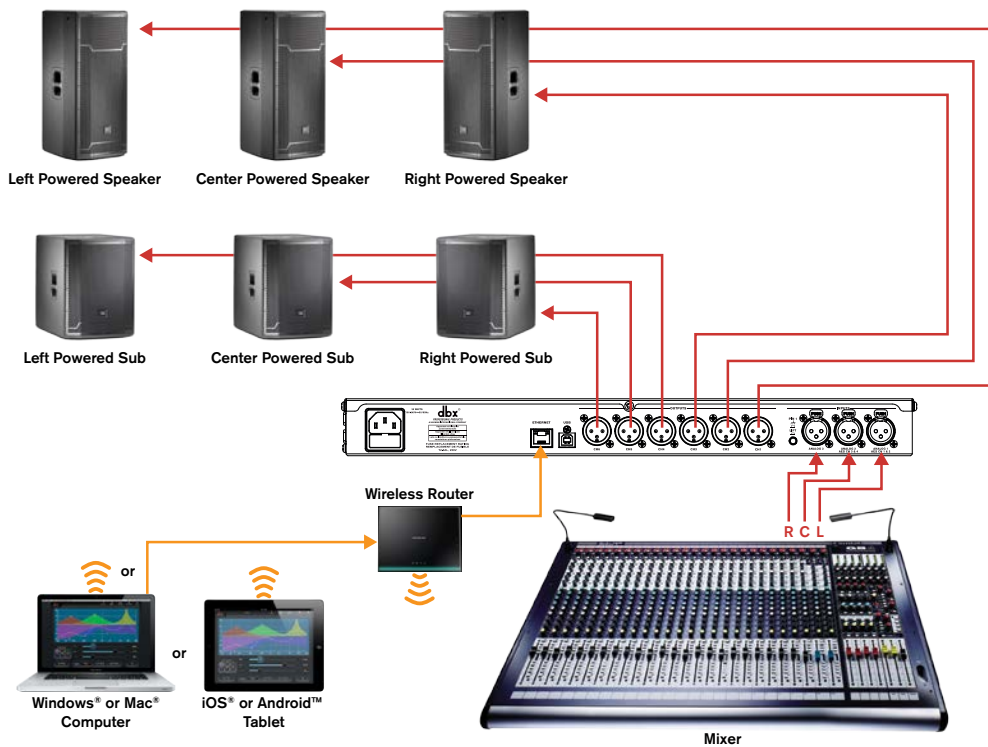

LEGEND

| | | | | |
|---------------------------|-----------------------|-------------|-----------------|------------------|
| → Analog Audio Connection | → Ethernet Connection | 1 Channel 1 | L Left Channel | C Center Channel |
| → Optional | Wi-Fi Signal | 2 Channel 2 | R Right Channel | A Aux Channel |

Application 5: Full Range Stage Monitors

This application is suited for use with up to 6 full range stage monitors.

Application Notes:

- Make sure your mixer and amplifiers (or powered speakers) are turned off before making connections.
- Make connections as described in **'Making Connections'** on page 4 then apply power to the system according to the instructions described in **'Applying Power'** on page 4.
- Press the **WIZARD** button then run the Setup Wizard and follow the on-screen instructions. Or, if you know your speakers and amps aren't listed in the Setup Wizard, you can simply load preset 99 and start from there.

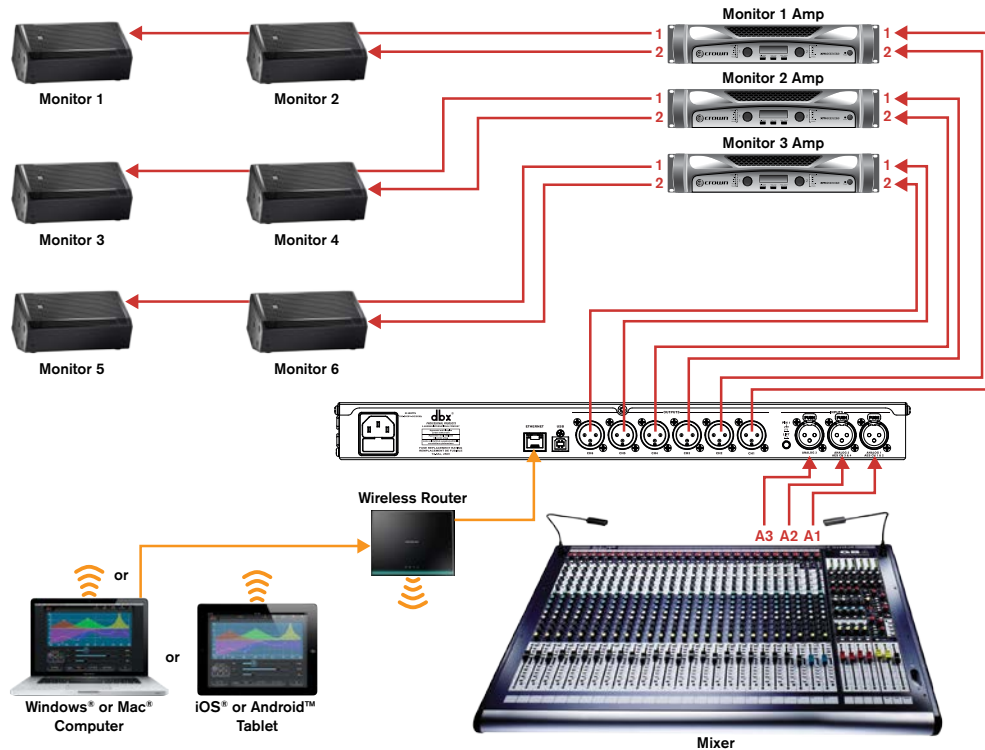

LEGEND

| | | | | |
|-------------------------|---------------------|-------------|-----------------|------------------|
| Analog Audio Connection | Ethernet Connection | 1 Channel 1 | L Left Channel | C Center Channel |
| Optional | Wi-Fi Signal | 2 Channel 2 | R Right Channel | A Aux Channel |

Application 6: Bi-Amplified Stage Monitors

This application is suited for use with up to 3 bi-ampable 2-way stage monitors.

Application Notes:

- Make sure your mixer and amplifiers (or powered speakers) are turned off before making connections.
- Make connections as described in **'Making Connections'** on page 4 then apply power to the system according to the instructions described in **'Applying Power'** on page 4.
- Press the **WIZARD** button then run the Setup Wizard and follow the on-screen instructions. Or, if you know your speakers and amps aren't listed in the Setup Wizard, you can simply load preset 100 and start from there.

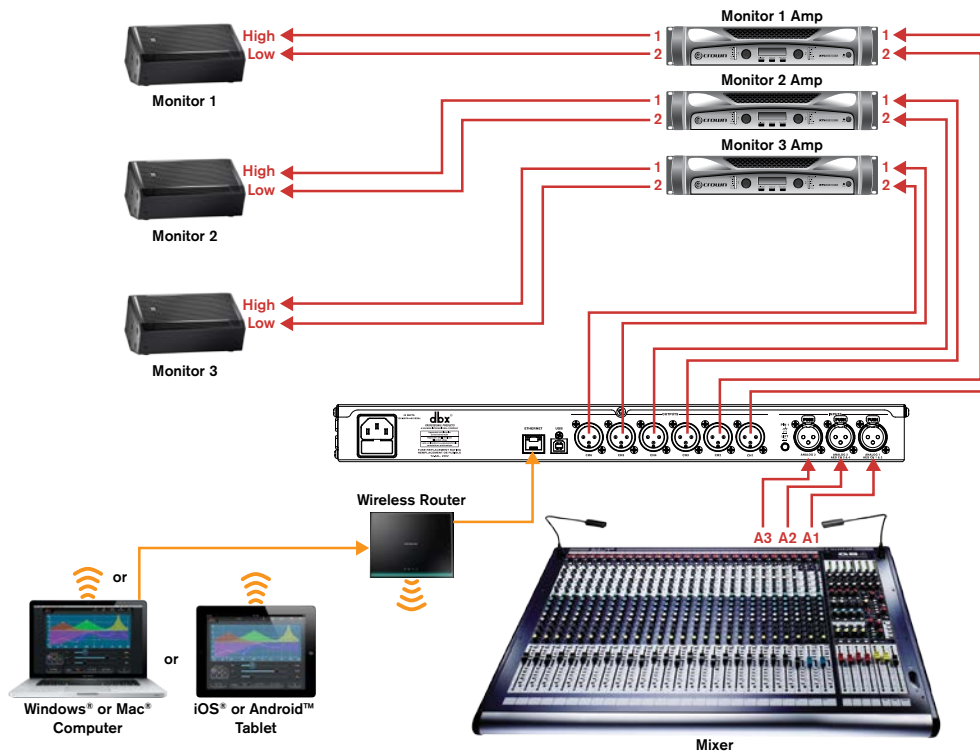

LEGEND

| | | | | |
|-------------------------|---------------------|-------------|-----------------|------------------|
| Analog Audio Connection | Ethernet Connection | 1 Channel 1 | L Left Channel | C Center Channel |
| Optional | Wi-Fi Signal | 2 Channel 2 | R Right Channel | A Aux Channel |

Application 7: Using The AES Digital Inputs

Any of the previous applications described can accommodate AES signals if you're using a digital mixer. This application illustrates the power and flexibility of the VENU360 and is suited for use with a digital console which has at least 2 AES outputs, a PA system up to 2-way, and up to 4 full range stage monitors.

When you use the first two XLR inputs in the VENU360 as AES digital inputs (which provides 4 channels of AES) along with the remaining analog input on the third XLR, the VENU360 is capable of taking in a total of 5 input signals. Although the VENU360 only has 3 input processing chains, it does allow you to route or mix input signals directly to output processing chains. This means that you could, for example, connect a mono FOH feed to the VENU360's analog 3 input and 4 aux-send monitor feeds to the AES inputs as shown in the below diagram. You would then need to determine which 3 of the 5 incoming signals will benefit most from the VENU360's input processing (specifically, Advanced Feedback Suppression).

In this application the FOH amplifier channels (main and sub amp channels) have been paralleled (or linked) – note that the amplifiers must have link/parallel jacks to do this. This frees up 2 outputs so that up to 4 stage monitors can be connected to the VENU360 outputs.

Application Notes:

- Make sure your mixer and amplifiers (or powered speakers) are turned off before making connections.
- Make connections as described in **'Making Connections' on page 4** then apply power to the system according to the instructions described in **'Applying Power' on page 4**.
- Press the **WIZARD** button then run the Setup Wizard and follow the on-screen instructions. Note that the Setup Wizard may not be able to fully configure the system depending on the application requirements. To complete the configuration, you may need to enter Configuration mode once the Setup Wizard is complete and re-route audio signals and/or change processing insert types, see **'Using Configuration Mode' on page 24** for information on manually configuring the VENU360.

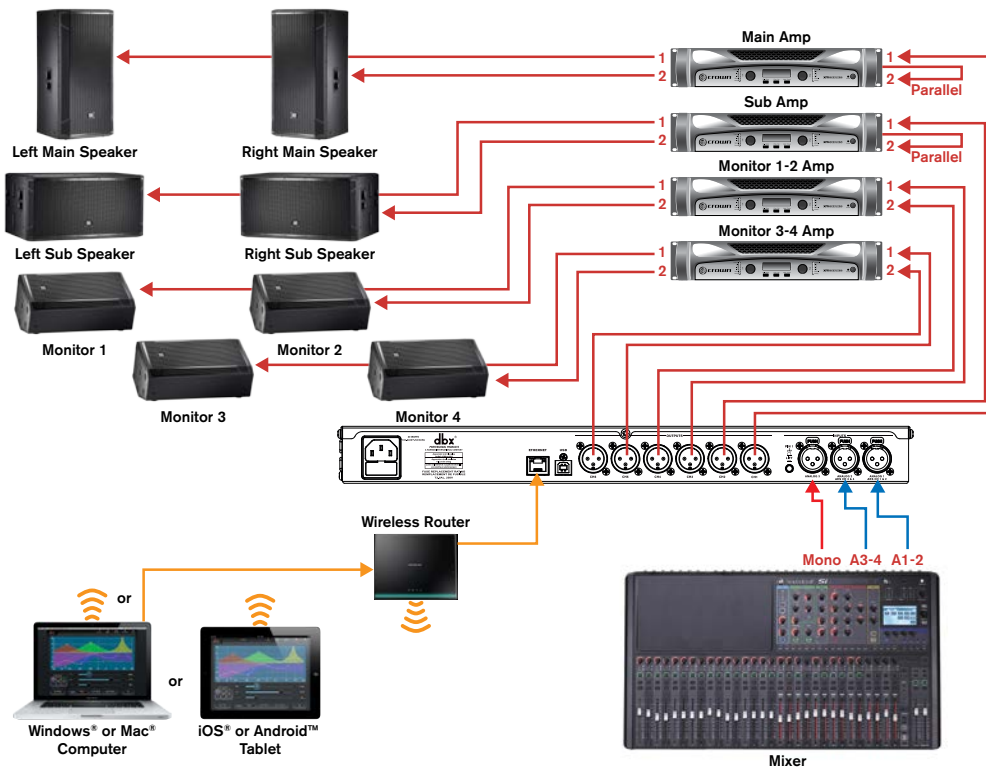

LEGEND

| | | | | |
|-------------------------|---------------------|-------------|-----------------|------------------|
| Analog Audio Connection | Ethernet Connection | 1 Channel 1 | L Left Channel | C Center Channel |
| AES Digital Connection | Wi-Fi Signal | 2 Channel 2 | R Right Channel | A Aux Channel |

Application 8: BLU Link Application (VENU360-B)

This application shows a BLU link ring comprised of a VENU360-B, a Soundcraft® Si Series mixer with the BLU link card option installed, and four dbx PMC16s for personal monitor control. This application would be well suited for house of worship.

The VENU360-B is being used to process the mains and subs for the FOH system as well as the two zones. The four PMC16s allow each of the musicians to tailor their own monitor mix. The last PMC16 in the BLU link chain is fed back to the mixer's BLU link input, which completes the BLU link ring and provides redundancy in the event one of the Ethernet cables in the ring is compromised.

Application Notes:

- Make sure your mixer and amplifiers (or powered speakers) are turned off before making connections.
- Make connections as described in **'Making Connections' on page 4** then apply power to the system according to the instructions described in **'Applying Power' on page 4**.
- Press the **WIZARD** button then run the BLU link and Setup Wizards and follow the on-screen instructions. Note that the Setup Wizard may not be able to fully configure the system depending on the application requirements. To complete the configuration, you may need to enter Configuration mode once the Setup Wizard is complete and re-route audio signals and/or change processing insert types, see **'Using Configuration Mode' on page 24** for information on manually configuring the VENU360-B.
- See the table on the following page for BLU link device channel assignment reference.

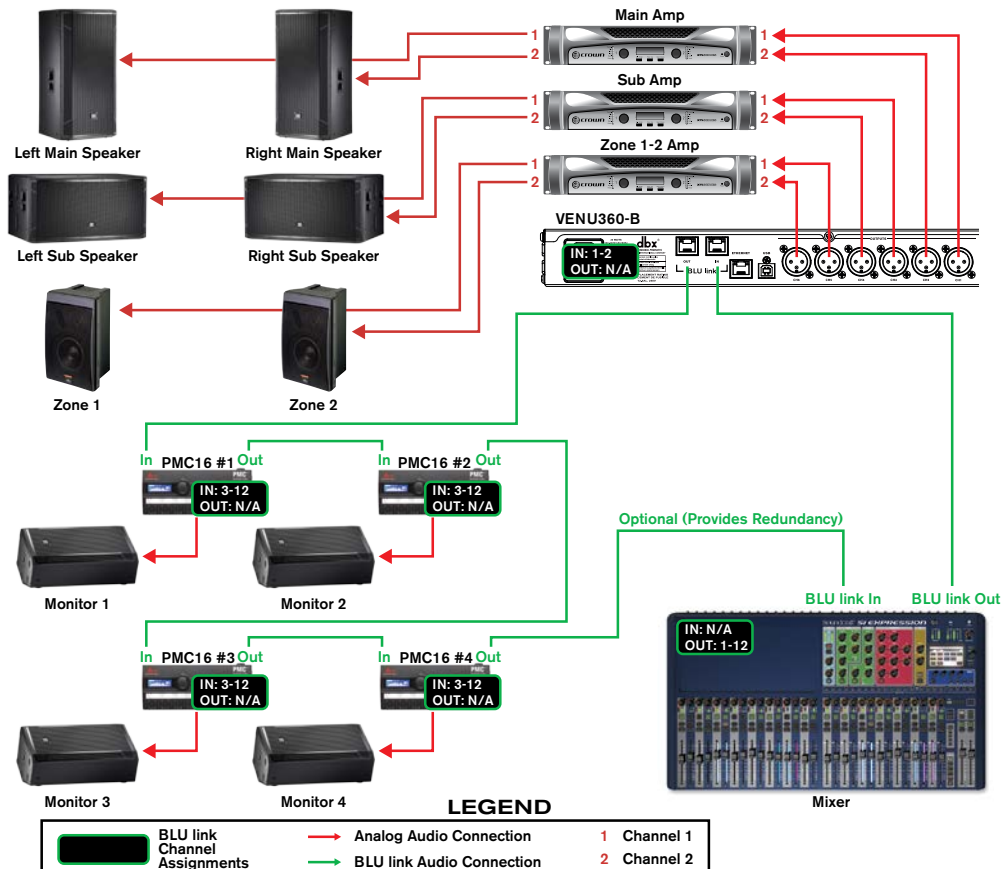

NOTE: Use CAT5e or higher straight-through cables for all BLU link connections.

BLU Link Channel Assignments

The below tables show the BLU link channel assignments for each of the devices shown in the BLU link application diagram on the previous page.

| Si Mixer Channel | BLU link Channel Assignment |
|-----------------------|-----------------------------|
| Left Master Out | 1 |
| Right Master Out | 2 |
| Drum Bus Out L | 3 |
| Drum Bus Out R | 4 |
| Guitar Bus Out L | 5 |
| Guitar Bus Out R | 6 |
| Keys Bus Out L | 7 |
| Keys Bus Out R | 8 |
| Backing Vox Bus Out L | 9 |
| Backing Vox Bus Out R | 10 |
| Lead Vox Bus Out | 11 |
| Bass Bus Out | 12 |

NOTE: See the Si Series Option Slot & Card User Guide for information on configuring the Si BLU Link Card's DIP switches.

| VENU360-B Channel | BLU link Channel Assignment |
|-------------------|-----------------------------|
| In 1 | 1 (Left Master Out) |
| In 2 | 2 (Right Master Out) |
| In 3 | N/A |
| In 4 | N/A |
| In 5 | N/A |
| In 6 | N/A |
| In 7 | N/A |
| In 8 | N/A |
| Out 1 | N/A |
| Out 2 | N/A |
| Out 3 | N/A |
| Out 4 | N/A |
| Out 5 | N/A |
| Out 6 | N/A |

| PMC16 Channel | BLU link Channel Assignment |
|---------------|-----------------------------|
| In 1 | 3 (Drums Bus Out L) |
| In 2 | 4 (Drum Bus Out R) |
| In 3 | 5 (Guitar Bus Out L) |
| In 4 | 6 (Guitar Bus Out R) |
| In 5 | 7 (Keys Bus Out L) |
| In 6 | 8 (Keys Bus Out R) |
| In 7 | 9 (Backing Vox Bus Out L) |
| In 8 | 10 (Backing Vox Bus Out R) |
| In 9 | 11 (Lead Vox Bus Out) |
| In 10 | 12 (Bass Bus Out) |
| In 11 | N/A |
| In 12 | N/A |
| In 13 | N/A |
| In 14 | N/A |
| In 15 | N/A |
| In 16 | N/A |

Application 9: Dante Application (VENU360-D)

This application shows a Dante network comprised of two VENU360-Ds and a Soundcraft® Si Series mixer with the Dante Card option installed.

The VENU360-D #1 device is being used to process the mains and subs for the FOH system as well as the 2 zones. The VENU360-D #2 device is being used to process the 6 stage monitors. The Secondary Dante ports from all devices have been connected to a second network switch to provide audio redundancy in the event any of the primary Ethernet cable connections are compromised.

Application Notes:

- Make sure your mixer and amplifiers (or powered speakers) are turned off before making connections.
- Make connections as described in **'Making Connections' on page 4** then apply power to the system according to the instructions described in **'Applying Power' on page 4**.
- Press the **WIZARD** button then run the Setup Wizard and follow the on-screen instructions. Note that the Setup Wizard may not be able to fully configure the system depending on the application requirements. To complete the configuration, you may need to enter Configuration mode once the Setup Wizard is complete and re-route audio signals and/or change processing insert types, see **'Using Configuration Mode' on page 24** for information on manually configuring the VENU360-D.
- Dante programming can be performed using Audinate's Dante Controller software.

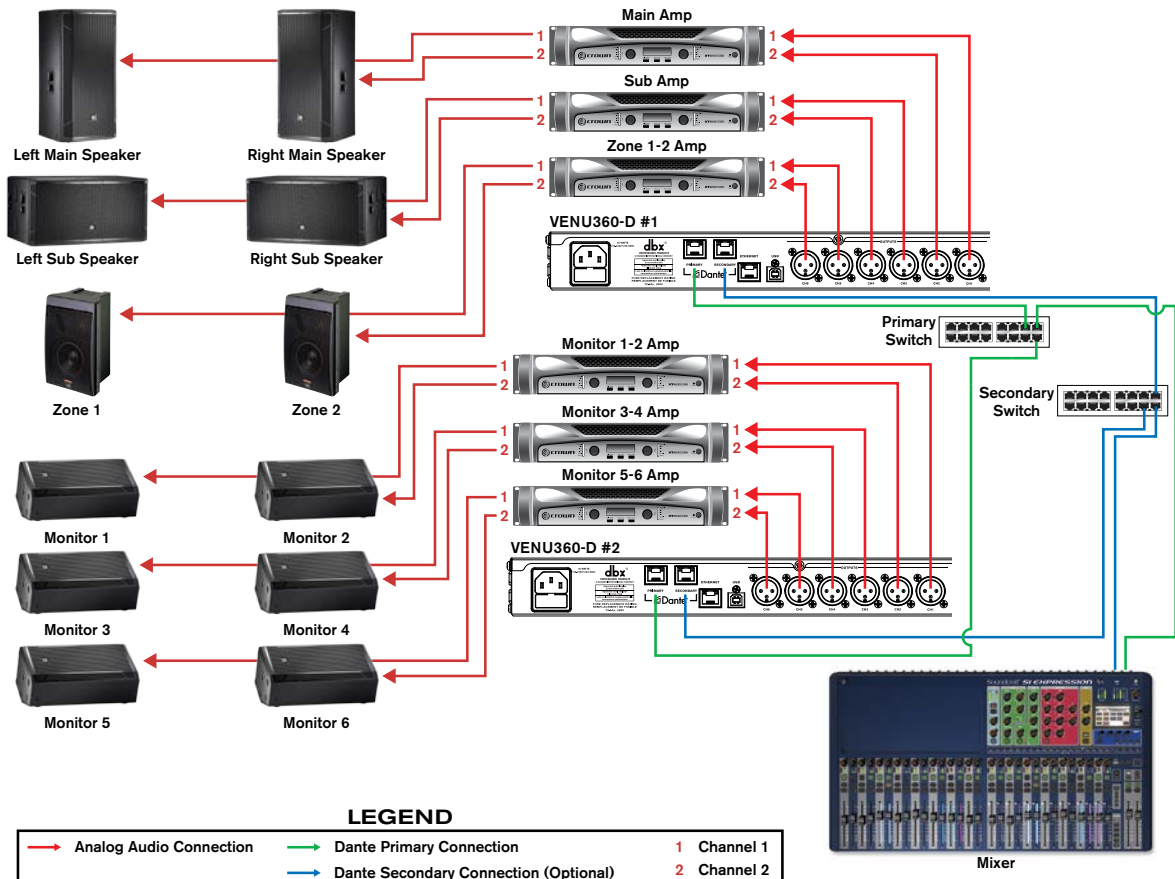

NOTE: For best performance and lowest latency, Gigabit network peripherals and CAT5e or higher cables are recommended for Dante connections. However, CAT5 Ethernet cables with 100Mbps network speeds may also be used in some applications, depending on Dante channel count, network size, network traffic, and sample rate.

Preset List

| User Preset # | Factory Preset # | Name | Crossover Configuration |
|---------------|------------------|---------------------------------|-------------------------|
| 1 | 76 | Stereo Full Range Mains | |
| 2 | 77 | Stereo Mains + Mono Sub | |
| 3 | 78 | Stereo Mains + Stereo Subs | |
| 4 | 79 | Stereo Mains + Aux Subs x2 | |
| 5 | 80 | Stereo Mains x4 + Mono Sub | |
| 6 | 81 | Stereo Mains x4 + Stereo Subs | |
| 7 | 82 | Stereo 2Way Mains | |
| 8 | 83 | Stereo 2Way Mains + Mono Sub | |
| 9 | 84 | Stereo 2Way Mains + Stereo Subs | |
| 10 | 85 | Stereo 2Way Mains + Aux Subs x2 | |
| 11 | 86 | Stereo 3Way Mains | |

| User Preset # | Factory Preset # | Name | Crossover Configuration |
|---------------|------------------|-----------------------------------|--|
| 12 | 87 | Mono Full Range Main | M-1:1-M FULL RANGE |
| 13 | 88 | Mono Mains x2 + Mono Sub | M-1:3-M MAIN 1 -M MAIN 2 -M SUB |
| 14 | 89 | Mono Mains x2 + Mono Subs x2 | M-1:4-M MAIN 1 -M MAIN 2 -M SUB 1 -M SUB 2 |
| 15 | 90 | Mono Mains x2 + Aux Subs x2 | M-2:4-M MAIN 1 A-M MAIN 2 -A SUB 1 -A SUB 2 |
| 16 | 91 | Mono 2Way Mains x2 | M-1:4-M HIGH 1 -M HIGH 2 -M LOW 1 -M LOW 2 |
| 17 | 92 | Mono 2Way Mains x2 + Mono Sub | M-1:5-M HIGH 1 -M HIGH 2 -M LOW 1 -M LOW 2 -M SUB |
| 18 | 93 | Mono 2Way Mains x2 + Mono Subs x2 | M-1:6-M HIGH 1 -M HIGH 2 -M LOW 1 -M LOW 2 -M SUB 1 -M SUB 2 |
| 19 | 94 | Mono 2Way Mains x2 + Aux Subs x2 | M-2:6-M HIGH 1 A-M HIGH 2 -M LOW 1 -M LOW 2 -A SUB 1 -A SUB 2 |
| 20 | 95 | Mono 3Way Mains x2 | M-1:6-M HIGH 1 -M HIGH 2 -M MID 1 -M MID 2 -M LOW 1 -M LOW 2 |
| 21 | 96 | LCR Full Range Mains | L-3:3-L FULL RANGE C-3:3-C FULL RANGE R-3:3-R FULL RANGE |
| 22 | 97 | LCR Mains + LCR Subs | L-3:6-L MAIN C-3:6-C MAIN R-3:6-R MAIN -L SUB -C SUB -R SUB |

| User Preset # | Factory Preset # | Name | Crossover Configuration |
|---------------|------------------|------------------------------|-------------------------|
| 23 | 98 | LCR 2Way Mains | |
| 24 | 99 | Full Range Stage Monitors x6 | |
| 25 | 100 | 2Way Stage Monitors x3 | |

TIP: All factory presets have 1x1 (full range) crossovers configured for any remaining available outputs. The signal feeding these outputs will be fully attenuated in the Mid Mixers for safety reasons. However, you can easily edit the settings in these Mid Mixers or quickly modify the configuration and change the mixing/routing options on these outputs for additional stage monitor, zone, or delay fill use.

Using The VENU360 Control Application

The DriveRack VENU360 control application is available for Android™, iOS®, Mac®, and Windows® compatible devices. This application is available for free and can be downloaded on the iTunes Store®, Google Play™, or from www.dbxpro.com.

The DriveRack VENU360 control application can be used to perform most of the same functions available from the VENU360's front panel, such as running all Wizards, changing configurations, viewing the RTA, editing processing parameters, and managing presets. The DriveRack VENU360 control app also adds the ability to connect directly to the online tuning database (Internet connection required), where you can download additional tunings from Crown®, JBL®, dbx®, and more!

NOTE: You can control one VENU360 device on the network at a time using the VENU360 control app. Multiple control devices can be connected to the VENU360 simultaneously, however, it is best to control the VENU360 from only one device at a time for best performance. For example, you may have the app running on a laptop that sits next to the mixing console and remains active during the entire performance and used for the RTA and occasional tweaks, and then use a tablet periodically when walking around the venue and making adjustments. Performance will be determined by the speed of the wired and/or wireless network. Generally speaking, connecting up to 3 apps simultaneously should work fine on standard 10/100 Mbps wired and 802.11n Wi-Fi networks.

Device Requirements

Visit dbxpro.com for the latest information on device requirements for the DriveRack VENU360 control application.

Networking

Networking Overview

The VENU360 can be connected to a network for control using the free VENU360 control app. The VENU360 supports DHCP and static IP addressing. The following section provides a brief description of the most common network settings.

- **IP address**

An identifier for a computer or device on a TCP/IP network. Each device in a network has its own IP address to identify it. Example: 126.126.17.42. Networks using the TCP/IP protocol route messages based on the IP address of the destination. An IP address is made of four numbers separated by periods. Each number can be zero to 255. The last number should not be a zero or 255. For example, 126.126.17.1 could be an IP address. 126.126.17.0 would not be a valid IP address.

A TCP/ IP or IP address has two parts: the NETWORK ID and the HOST ID. The NETWORK ID identifies the network, and the HOST ID identifies either the subnet and device, or just the device if there is no subnet. The subnet mask is a code that indicates which part of the TCP/IP address is the NETWORK ID and which part is the HOST ID. In subnet-mask code, 255 means "This part of the address is the NETWORK ID". Example: Suppose the IP ADDRESS of a device is 192.168.xx.yy and the SUBNET MASK is 255.255.x.y. That means, (192.168) is the NETWORK ID. The remaining set of numbers (xx.yy) is the HOST ID. If your network stands alone (it is not part of a larger network) then the HOST ID identifies each device in the network. If your network is part of a venue's larger network, your network is actually a sub-network or subnet.

- **Subnet**

A small network within a larger network. For example, a TCP/IP network might be a subnet of a venue's network, which could include computers throughout the building, or a network might be divided into subnets. For example, in a large installation, there may be one subnet per rack or room.

- **DHCP (Dynamic Host Configuration Protocol)**

This is a protocol for automatically assigning IP addresses to devices on a network. With dynamic (DHCP) addressing, a device might have a different IP address every time it connects to the network. DHCP relies on a DHCP server to assign and manage IP addresses.

- **Gateway**

A gateway is used to connect two different networks and allow packets to be passed between them. In a typical home network, the router provides the "gateway" connection between the local area network (LAN) and Internet so they can communicate. A gateway can translate between one network system or protocol and another.

Network Security

Careful planning should be made before placing a VENU360 on a network that provides any access to the public. Some examples of public access are direct access to the device using an unsecured or weakly secured wireless network, or a network jack in a public area that provides network access to the VENU360. It is highly recommended that the VENU360 be placed on a protected, isolated network that does not have any connection to the public to prevent unauthorized users from reconfiguring or controlling the device. Most routers and switches have built-in functions which help protect the network from unauthorized users, such as MAC address filtering, encryption, and disabling the SSID broadcast. Check the documentation for your network switch or router for information on configuring available security options.

Network Troubleshooting

The VENU360 ships with DHCP enabled. If you are connecting the VENU360 to a network which has a router or switch with an enabled DHCP server, connecting the VENU360 to the network should be as easy as plugging the VENU360 into the switch/router with the correct type of Ethernet cable. However, some additional configuration may be required if you're using static IP addressing, Auto-IP addressing, or network security features. If you are having difficulty connecting to the VENU360 over the network, try following the below steps to resolve the issue.

NOTE: If your computer has multiple Network Interface Cards (NICs) installed, the VENU360 control app will automatically use the first NIC configured in your computer. This means that only VENU360 devices connected to the first NIC will be auto-discovered and displayed in the VENU360 control app's device discovery window. To connect to a VENU360 connected to other NICs in the computer, the IP address of the VENU360 device must be manually entered in the VENU360 control app discovery screen in order to control the VENU360 device.

1. Ensure All Networked Devices Are Powered On

Ensure the networked control device, all network peripherals (i.e., switches, routers, or bridges), and the VENU360 are powered on and wait a few minutes to allow all devices to boot and get assigned IP addresses.

2. Check Ethernet Port LEDs, Cables, & Connections

Ensure the yellow and green LEDs are lighting on the VENU360's Ethernet port. If using a wired connection from a computer, ensure that these LED indicators are also lighting on your computer's Ethernet port. If connecting to a switch or router, ensure the activity LEDs for the connected ports are lighting on it as well. If any of these LEDs are not lighting, try disconnecting then reconnecting the corresponding Ethernet cables. If any of these LEDs are still not lighting, try swapping out the connected Ethernet cable for another known-working cable.

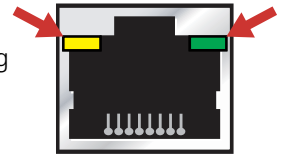

If an Ethernet port's LEDs begin lighting after reconnecting or swapping out cables, wait a few minutes then try reconnecting with the VENU360 control app. If you still can't connect, go to step 3.

3. Check IP Addresses & Network Settings

To check the VENU360's IP address, press the **UTILITY** button then select the "System Info" menu option using the **SELECT** wheel. Ensure the VENU360 has been assigned an IP address.

If the VENU360's IP address reads "Disconnected" when an Ethernet cable is connected, this indicates the connected computer, switch, or router is not powered on or the connected Ethernet cable may be faulty. Please verify all networked devices are powered on and that all connected cables are known-working.

If the VENU360's IP address reads "0.0.0.0", wait a few minutes to see if an IP address gets assigned. If no IP address is assigned, this indicates that the VENU360 is communicating with the network but cannot be assigned an IP address. This could indicate a problem with the DHCP server settings in the switch/router, an Ethernet cable, or that the wrong type of Ethernet cable is being used for the application (see step 4).

If using static IP or Auto-IP addressing, go into the VENU360's Utility menu by pressing the **UTILITY** button then select the "Network" menu option. Make sure DHCP is turned off and that the network settings are configured properly for connecting to the network, see '**Networking Overview**' on page 114 for further information on network settings.

If the VENU360 control app still won't connect, go to step 4.

4. Check The Type Of Ethernet Cables Used

Ensure you are using the correct type of Ethernet cables for the application. If you're connecting directly to the VENU360 using a Mac® or Windows® computer, you must use a crossover Ethernet cable. If connecting to a switch or router that does not support auto-MDI/MDIX, straight-through cables must be used, see '**Network Connections**' on page 5 and '**Ethernet Cable Recommendations & Diagrams**' on page 119 for further information.

If you've verified you are using the correct type of Ethernet cables and all cables are known-working but you still can't connect, go to step 5.

5. Check Switch/Router Configuration Settings

Check the settings in your network switch or router (consult the documentation which came with your network switch or router to see how to enter the utility used for configuring it). If you wish to use DHCP, ensure the DHCP server is enabled and that the DHCP address range is properly configured.

If the VENU360 and control device have compatible network settings but still won't communicate, traffic is likely being prohibited by a software or hardware firewall. If connecting using a switch or router that has an enabled hardware firewall, try disabling the firewall and then relaunching the VENU360 control app. If this fixes the problem, refer to your switch/router documentation on how to reconfigure the firewall to allow the VENU360 control app, or ports 19272 (TCP and UDP) and port 21 (FTP), to pass through the firewall.

6. Software Firewall

If connecting using a Mac® or Windows® computer, check any enabled software firewalls in the computer. Try disabling the firewall and then relaunching the VENU360 control app. If this fixes the problem, refer to your firewall manufacturer's documentation on how to reconfigure your firewall to allow the VENU360 control app, or ports 19272 (TCP and UDP) and port 21 (FTP), to pass through the firewall.

Technical Information

Firmware Updates

The USB or Ethernet connector on the back panel of the VENU360 can be used to perform firmware updates. Connect the USB port to a compatible computer for performing firmware updates using the VENU360 Firmware Update Utility application. As firmware updates becomes available, the Firmware Update Utility application will be available on the VENU360 product page at dbxpro.com.

If using the DriveRack VENU360 control app, you can update the VENU360 via the Ethernet port straight from the application, regardless of the device you're using for control (i.e., iOS®, Android™, Mac®, or Windows® device). Follow the included instructions provided with each application to perform the update procedure.

DSP Block Diagram

OUTPUTS

INPUTS

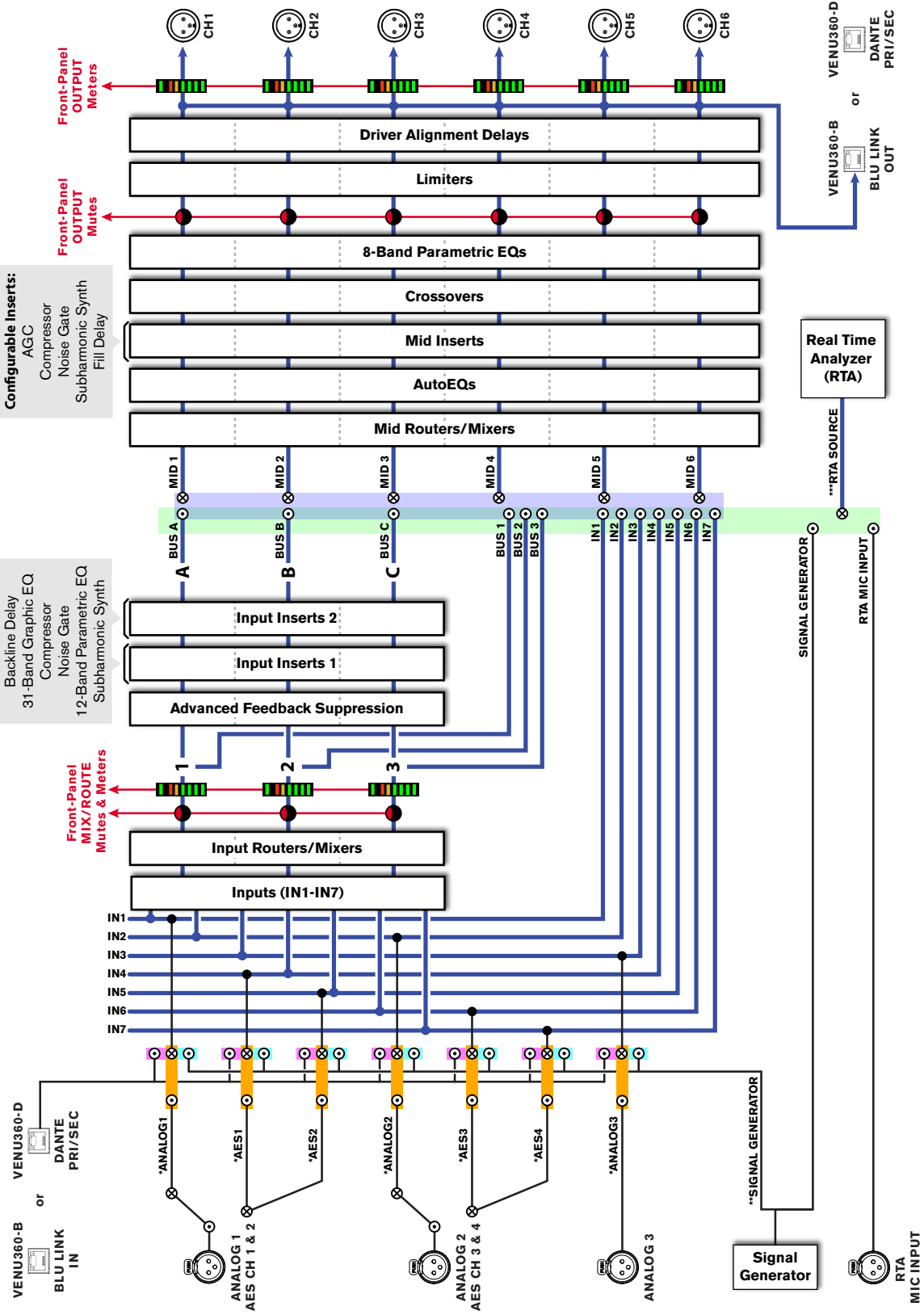

- *Default Input channel assignments. Input channel assignments can be edited in VENU360-B and VENU360-D models to include BLU link or Dante channels.
- **Signal Generator can be routed to any single input (IN1-IN7) or all inputs simultaneously (IN1-IN7). Input channels are "unrouted" when Signal Generator is routed to a channel.
- ***RTA source selections includes: RTA Mic Input, Signal Generator, IN1-IN7, or Buses (including bus summing options listed below).
- The following routing/mixing options are available for each output processing chain: IN1, IN2, IN3, IN4, IN5, IN6, IN7, mix all inputs (IN1-IN7), Bus 1, Bus 2, Bus 1+2 sum, Bus 2+3 sum, Bus 1+2+3 sum, mix Buses 1/2/3, Bus A, Bus B, Bus C, Bus A+B sum, Bus B+C sum, Bus A+B+C sum, mix Buses A/B/C.

Ethernet Cable Recommendations & Diagrams

Straight-Through

Use straight-through CAT5, CAT5e, or CAT6 Ethernet cables to connect the VENU360 to your network switch/router.

For Dante connections, Gigabit network peripherals and CAT5e or higher straight-through cables are recommended for best performance and lowest latency. However, CAT5 Ethernet cables with 100Mbps network speeds may also be used in some applications, depending on Dante channel count, network size, network traffic, and sample rate. CAT5e or higher straight-through cables should be used for all BLU link connections. The maximum Ethernet cable length between Dante or BLU link devices should not exceed 328ft (100m). The below diagrams show the pinout of straight-through Ethernet cables. These are the most common type of Ethernet cables available.

TIA/EIA 568A Straight-Through Cable Pinout

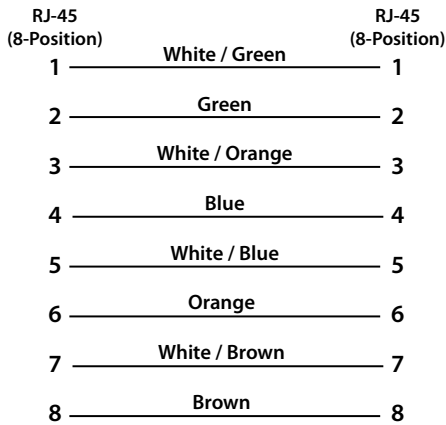

TIA/EIA 568B Straight-Through Cable Pinout

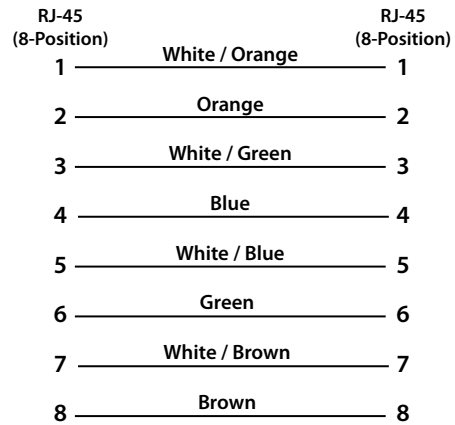

Crossover

For data network connections, CAT5, CAT5e, or CAT6 crossover Ethernet cables can be used with network switches or routers which support auto-MDI/MDIX sensing. This feature allows the switch/router to detect whether a straight-through or crossover cable is connected and re-configure itself accordingly. Crossover cables must be used when connecting a desktop or laptop computer directly to the VENU360 for network control. The below diagrams show the pinouts of crossover cables.

TIA/EIA 568A Crossover Cable Pinout

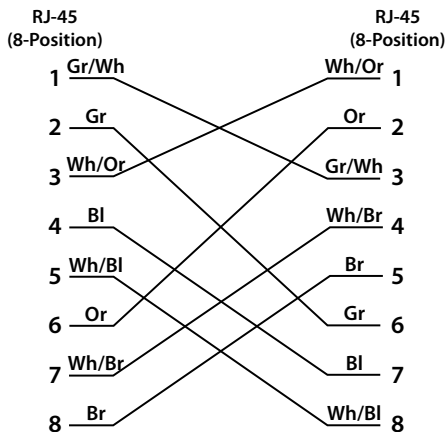

TIA/EIA 568B Crossover Cable Pinout

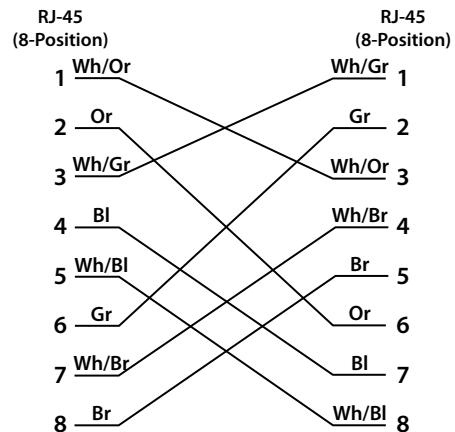

Audio Cable Diagrams

| | |
|--|---|
| <p>FROM SOURCE DEVICE (OUTPUT) TO NEXT DEVICE (INPUT)</p> <p>FEMALE XLR TO TRS PHONE</p> | <p>FROM SOURCE DEVICE (OUTPUT) TO NEXT DEVICE (INPUT)</p> <p>TRS PHONE TO MALE XLR</p> |
| <p>FROM SOURCE DEVICE (OUTPUT) TO NEXT DEVICE (INPUT)</p> <p>TRS PHONE TO TRS PHONE</p> | <p>FROM SOURCE DEVICE (OUTPUT) TO NEXT DEVICE (INPUT)</p> <p>FEMALE XLR TO MALE XLR</p> |
| <p>FROM SOURCE DEVICE (OUTPUT) TO NEXT DEVICE (INPUT)</p> <p>TS PHONE TO MALE XLR</p> | <p>FROM SOURCE DEVICE (OUTPUT) TO NEXT DEVICE (INPUT)</p> <p>TS PHONE TO TRS PHONE</p> |
| <p>FROM SOURCE DEVICE (OUTPUT) TO NEXT DEVICE (INPUT)</p> <p>RCA PHONO TO MALE XLR</p> | <p>FROM SOURCE DEVICE (OUTPUT) TO NEXT DEVICE (INPUT)</p> <p>RCA PHONO TO TRS PHONE</p> |
| <p>FROM SOURCE DEVICE (OUTPUT) TO NEXT DEVICE (INPUT)</p> <p>TS PHONE TO TS PHONE</p> | <p>FROM SOURCE DEVICE (OUTPUT) TO NEXT DEVICE (INPUT)</p> <p>RCA PHONO TO TS PHONE</p> |
| <p>FROM SOURCE DEVICE (OUTPUT) TO NEXT DEVICE (INPUT)</p> <p>TRS PHONE TO TS PHONE</p> | <p>FROM SOURCE DEVICE (OUTPUT) TO NEXT DEVICE (INPUT)</p> <p>TS PHONE TO RCA PHONO</p> |
| <p>FROM SOURCE DEVICE (OUTPUT) TO NEXT DEVICE (INPUT)</p> <p>TRS PHONE TO RCA PHONO</p> | |

Dimensions

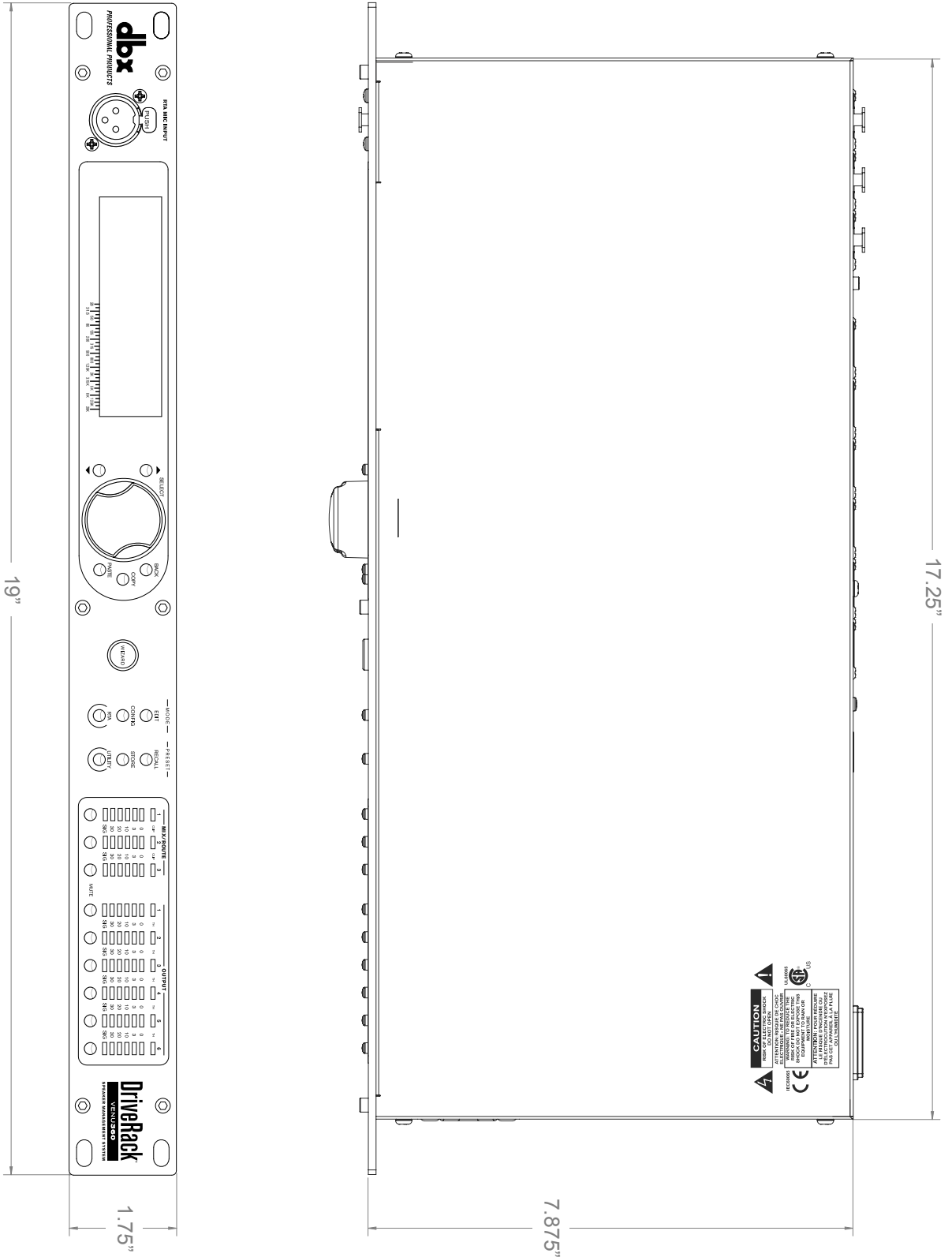

Specifications

ANALOG INPUTS

| | |
|--------------------------------|---|
| Number of Inputs: | 3 analog line inputs/2 AES digital inputs (shared connectors), 1 RTA mic input |
| Connectors: | 3 female XLRs (2 selectable between analog/AES digital audio formats), 1 female XLR RTA mic input |
| Type: | Electronically balanced/RF filtered |
| Impedance: | > 30 k Ω , balanced line to line |
| Max Input Level (line inputs): | > +28 dBu, balanced, \leq 1% THD |
| CMRR: | > 50 dB @ 1 kHz |
| RTA Mic Preamp Phantom Power: | +48 VDC |

ANALOG OUTPUTS

| | |
|--------------------|--------------------------------------|
| Number of Outputs: | 6 line outputs |
| Connectors: | Male XLR |
| Type: | Electronically balanced, RF filtered |
| Impedance: | 120 Ω , balanced line to line |
| Max Output Level: | +22 dBu, balanced, \leq 1% THD |
| Alignment Delay: | Up to 1000 ms per output channel |

A/D PERFORMANCE

| | |
|------------------------|---|
| A/D Converter: | 24-bit with dbx Type IV™ Conversion System |
| A/D Dynamic Range: | 117 dB A-weighted, 114 dB unweighted, 22 kHz BW |
| Type IV Dynamic Range: | 129 dB with transient material, A-weighted, 22 kHz BW; 126 dB with transient material, unweighted, 22 kHz BW; 121 dB typical with program material, A-weighted, 22 kHz BW |

D/A PERFORMANCE

| | |
|--------------------|---|
| D/A Converter: | 24-bit |
| D/A Dynamic Range: | 116 dB A-weighted, 113 dB unweighted, 22 kHz BW |

SYSTEM PERFORMANCE

| | |
|---------------------------------|---|
| Internal Processing Wordlength: | 32-bit floating point |
| Supported Sample Rates: | 48/96 kHz (32-192 kHz using sample rate conversion) |
| Dynamic Range: | 114 dB A-weighted 110 dB unweighted |
| THD+Noise: | 0.0025% typical at +4 dBu, 1 kHz, 0 dB input gain |
| Frequency Response: | 20 Hz – 20 kHz, +0 /- 0.5 dB |
| Interchannel Crosstalk: | < -97 dB, -105 dB typical 20-20 kHz, +4 dBu, all channels measured |
| Latency: | Analog input to output: 2.57 ms (48 kHz), 2.28 ms (96 kHz) Digital AES input to output: 2.31 ms (48 kHz), 2.15 ms (96 kHz) |

BLU LINK AUDIO

| | |
|-----------------------|---|
| Connectors: | 2 x RJ-45 Ethernet connectors |
| Maximum Nodes: | Up to 60 devices |
| Maximum Cable Length: | 100m/328ft on Category 5e or higher cable between devices |
| Latency: | 11/Fs [0.23ms@48k, 0.11ms@96k] |
| Pass Through Latency: | 4/Fs [0.08ms@48k, 0.04ms@96k] |

DANTE™ AUDIO

Connectors: 2 x RJ-45 connectors
Maximum Cable Length: 100m/328ft on Category 5 (100Mbps) or Category 5e/Category 6 (Gigabit) cable between devices
Latency: 0.15ms-5.0ms

POWER SUPPLY

Operating Voltage: 100-240 VAC 50/60 Hz
Power Consumption: 30 Watts

PHYSICAL

Unit Weight: VENU360: 5.48 lbs. (2.49 kg)
VENU360-B: 5.58 lbs. (2.53 kg)
VENU360-D: 5.58 lbs. (2.53 kg)

Shipping Weight: VENU360: 7.10 lbs. (3.22 kg)
VENU360-B: 7.2 lbs (3.27 kg)
VENU360-D: 7.2 lbs (3.27 kg)

Dimensions: 1.75" (H) x 8.0" (D) x 19.0" (W)

Specifications are subject to change without notice.

Additional Resources

dbx Website

<http://dbxpro.com>

DriveRack VENU360 Product Pages

<http://dbxpro.com/en-US/products/driverack-VENU360>

<http://dbxpro.com/en-US/products/driverack-venu360-b>

<http://dbxpro.com/en-US/products/driverack-VENU360-d>

dbx Support

<http://dbxpro.com/en-US/support>

dbx User's Forum

<http://dbxpro.com/forum>

Dante Controller Software

<https://www.audinate.com/products/software/dante-controller>



Phone: (801) 566-8800

Website: dbxpro.com

Support: dbxpro.com/en-US/support

dbx Professional Products
is a registered trademark of Harman

© 2015 Harman

All rights reserved

DriverRack® VENU360 Owner's Manual

PN: 5058681-B

