

# **SHURE**<sup>®</sup>

LEGENDARY  
PERFORMANCE™

WIRED MICROPHONE

# MX395 USER GUIDE

Le Guide de l'Utilisateur

Bedienungsanleitung

Guia del Usuario

Guida dell'Utente

Manual do Usuário

Руководство пользователя

日本語

사용자 가이드

繁體中文



© 2015 Shure Incorporated  
27A3237 (Rev. 7)  
Printed in U.S.A.



# Low-Profile Boundary Microphone

## General Description

Shure® MX395 low-profile microphones are for use in boardrooms and other sites where aesthetics are important. The MX395 is only 2.5 cm (1 in.) in diameter, and extends just 2 cm above the mounting surface when installed. Despite its small size, the MX395 delivers clear, high quality sound.

## Features

- Low profile, aesthetic design
- Wide dynamic range and smooth frequency response
- RF filtering with CommShield® technology
- Available with logic-controlled bi-color status indicator

## Model Variations

The MX395 is available in cardioid, omnidirectional, and bidirectional polar patterns, with or without an LED status indicator, with a black, white, or aluminum finish.

## Furnished Accessories

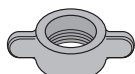

Wing Nut  
65A2190



Rubber Isolation Ring  
66A405



5-pin XLR, Female  
(MX395-LED variations)  
95A2529

## Polar Patterns

The polar pattern is indicated by the molded grille.

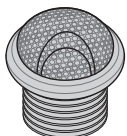

Cardioid

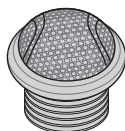

Bidirectional

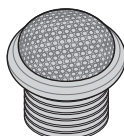

Omnidirectional

## Microphone Placement

For best low-frequency response and rejection of background noise, place the microphone on a large, flat surface, such as a floor, table, or lectern.

To reduce reverberance, avoid reflective surfaces above or to the side of the microphone, such as beveled sides of pulpits or overhanging shelves.

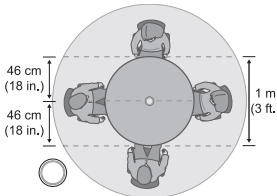
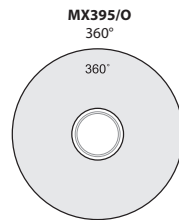
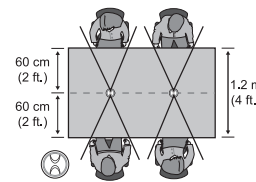
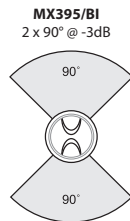
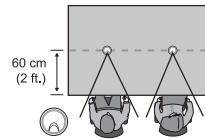
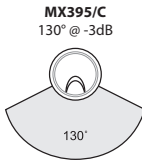

## DIP Switches

Set DIP Switch 1 up to engage the low cut filter, which attenuates frequencies by 6 dB per octave below 150 Hz.

Switch	Down (default)	Up
1	Full frequency response	Low cut filter
2	--	--

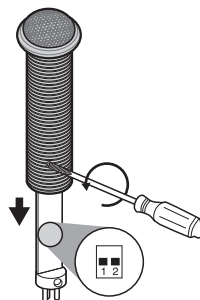

## Installation

Install the microphone into a tabletop as shown.

### Important:

- Align indentation toward talker
- Do not over tighten the wing nut, as this reduces shock isolation

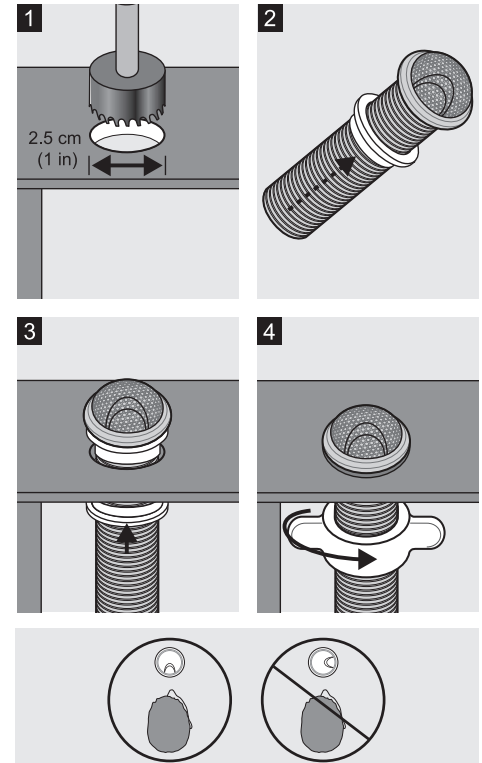

## LED Logic

For models equipped with an LED, use the included 5-pin XLR connector to wire the microphone to an automatic mixer or other logic device.

**Note:** Connect the LED IN to the gate output to illuminate the LED when the channel is gated on.

Do not use the relay ports on Crestron and AMX devices. Use the I/O logic ports instead.

The LED logic may not function when connecting to devices that do not have internal "pull-up resistor" logic circuits, such as ClearOne DSP products. External pull-up resistor circuits can be added for each microphone. Visit [www.shure.com/FAQ](http://www.shure.com/FAQ) for detailed instructions.

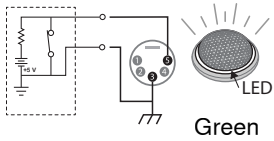

0 V c.c.

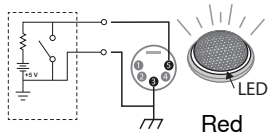

5 V c.c.

## Pin Assignments

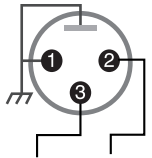

Audio - Audio +

3-Pin XLR

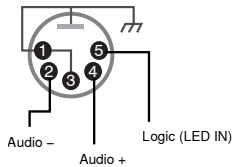

5-Pin XLR

## Specifications

All measurements taken with microphone mounted on a wooden surface (76 x 76 cm)

### Cartridge Type

Electret Condenser

### Frequency Response

50–17000 Hz

### Polar Pattern

MX395/O	Omnidirectional
MX395/C	Cardioid
MX395/BI	Bidirectional

### Output Impedance

170  $\Omega$

### Output Configuration

Active Balanced

### Sensitivity

@ 1 kHz, open circuit voltage

Cardioid	–35 dBV/Pa (18 mV)
Omnidirectional	–28 dBV/Pa (42 mV)
Bidirectional	–37 dBV/Pa (14 mV)

1 Pa=94 dB SPL

### Maximum SPL

1 kHz at 1% THD, 1 k $\Omega$  load

Cardioid	121 dB
Omnidirectional	114 dB
Bidirectional	123 dB

### Equivalent Output Noise

A-weighted

Cardioid	28 dB SPL
Omnidirectional	21 dB SPL
Bidirectional	29 dB SPL

### Signal-to-Noise Ratio

Ref. 94 dB SPL at 1 kHz

Cardioid	66 dB
Omnidirectional	73 dB
Bidirectional	65 dB

### Dynamic Range

1 k $\Omega$  load, @ 1 kHz

Cardioid	93 dB
Omnidirectional	93 dB
Bidirectional	94 dB

### Common Mode Rejection

10 to 100,000 kHz

45 dB, minimum

### Preamplifier Output Clipping Level

at 1% THD

–8 dBV (0.4 V)

### Logic Connections

LED IN	Active low ( $\leq 1.0V$ ), TTL compatible. Absolute maximum voltage: -0.7V to 50V.
--------	---

### Net Weight

136 g (0.30 lbs)

### Environmental Conditions

Operating Temperature	–18–57°C (0–135°F)
Storage Temperature	–29–74°C (–20–165°F)
Relative Humidity	0–95%

### Power Requirements

MX395	11–52 V DC, 2.0 mA
MX395-LED	48–52 V DC, 8.0 mA

## MX395/C

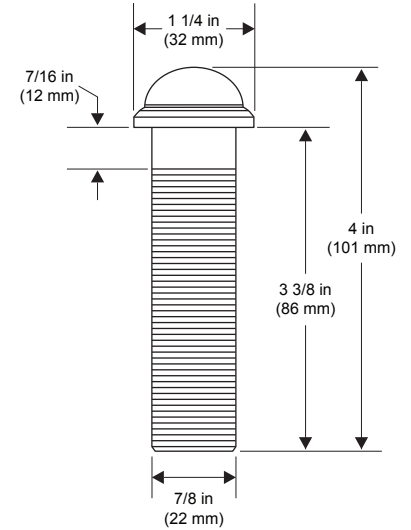
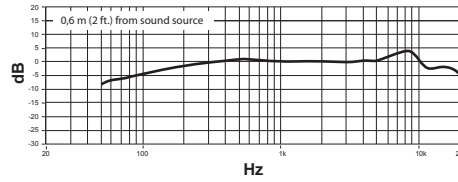
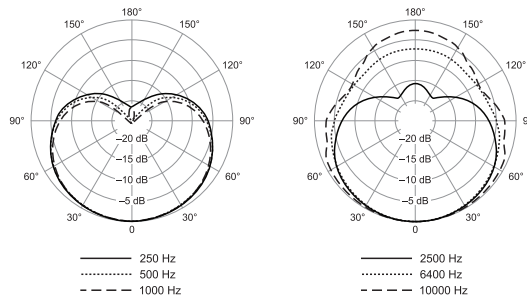

## MX395/BI

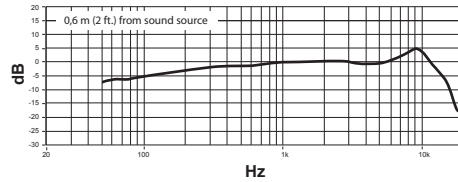
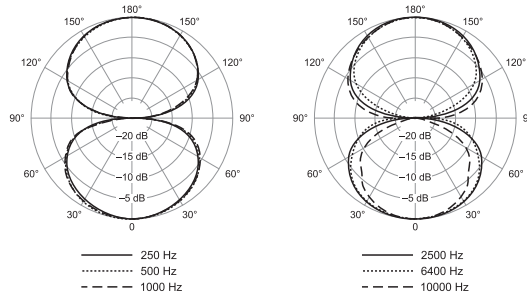

## MX395/O

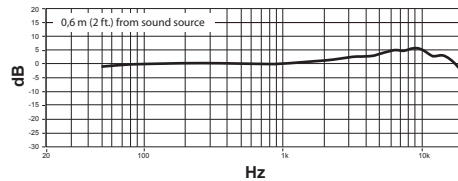
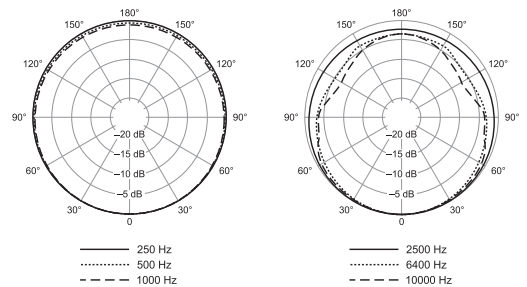

### Preamp Gain

If necessary, the preamplifier gain can be reduced by 12 dB. Contact an authorized Shure service center for information.

### Gain du préampli

Si nécessaire, il est possible de réduire de 12 dB le gain du préamplificateur. Contacter un centre de réparations Shure agréé pour plus de détails.

### Verstärkung des Vorverstärkers

Bei Bedarf kann die Vorverstärkung um 12 dB verringert werden. Informationen sind vom Shure-Vertragskundendienst zu erhalten.

### Ganancia del preamplificador

De ser necesario, la ganancia del preamplificador puede reducirse por 12 dB. Comuníquese con un centro de servicio autorizado de Shure para más información.

### Guadagno del preamplificatore

Se necessario, il guadagno del preamplificatore può essere ridotto di 12 dB. Per ulteriori informazioni, rivolgetevi a un centro di assistenza Shure autorizzato.

### Ganho do Pré-amplificador

Se necessário, o ganho do pré-amplificador pode ser reduzido em 12 dB. Entre em contato com um centro de serviços autorizados Shure para informações.

### Кoeffициент усиления предусилителя

Если потребуется, коэффициент усиления предусилителя можно снизить на 12 дБ. За информацией обращайтесь в официальный сервис-центр компании Shure.

### プリアンプゲイン

必要であれば、プリアンプのゲインを12 dB下げることができます。詳しくは、Shure認可サービスセンターまでお問い合わせください。

### 프리앰프 게인

필요하면, 프리앰프 게인을 12 dB만큼 줄일 수 있습니다. 안내를 원하시면 Shure 공인 서비스 센터에 연락하십시오.

### 前置放大器增益

可以根据需要, 将前置放大器增益降低 12 dB。有关详细信息, 请与 Shure 的授权服务中心联系。

**SHURE**<sup>®</sup>  
LEGENDARY  
PERFORMANCE™