



BEDIENUNGSANLEITUNG

OPERATING INSTRUCTIONS

NOTICE D'UTILISATION

MANUAL DEL USUARIO

Opus 600

Drahtloses Mikrofonsystem

Wireless Microphone System

Système de microphone sans fil

Sistema inalámbrico

1.	Safety and environment	34
1.1	NE 600 diversity receiver	34
1.2	S 600 / TS 600 transmitters.	36
1.3	Disposal	36
2.	NE 600 diversity receiver	38
2.1	Controls and indicators.	38
2.2	How to connect the antennae	40
2.3	Where to place the receiver	40
2.4	Connections	40
2.5	How to operate the receiver	41
2.6	How to adjust the squelch	41
2.7	Channel / frequency selection	42
2.8	How to transmit the frequency to the transmitter / ACT function	42
2.9	How to install the receiver into a 19" rack	42
2.10	How to connect and position remote antennae	43
2.11	ZAS 800 antenna splitter	44
2.11.1	Controls and indicators	44
2.11.2	Installation	44
2.11.3	General information	45
3.	S 600 handheld transmitter	46
3.1	Controls and indicators.	46
3.2	How to insert the batteries / rechargeable batteries	46
3.3	How to operate the handheld transmitter.	47
3.4	How to change the microphone capsule.	47
3.5	How to set the low-cut filter	48
3.6	Maintenance	48
4.	TS 600 beltpack transmitter	50
4.1	Controls and indicators.	50
4.2	How to insert the batteries / rechargeable batteries	51
4.3	How to operate the beltpack transmitter	52
4.4	Adjusting the input gain	52
4.5	AF connection	53
5.	General instructions for all transmitters	54
5.1	Battery change	54
5.2	Before the soundcheck	54
5.3	Positioning of transmitters if interference occurs.	54
5.4	What to do to avoid feedback	54
6.	Trouble shooting	55
6.1	NE 600 diversity receiver	55
6.2	Handheld and beltpack transmitter.	55
7.	Maintenance	56
8.	Licensing	56
9.	Components	56
10.	Optional accessories.	57
11.	Technical specifications.	58
	EC Declaration of Conformity	121

Thank you for selecting the Opus 600 wireless system. Please take some time to read carefully through this manual before setting up the equipment.

Important:

- When you unpack the product, inspect it for transport damage. If you do find transport damage, notify the transportation company without delay. Delay in reporting transport damage could result in the loss of your rights to compensation.

1. Safety and environment

1.1 NE 600 diversity receiver



The lightning flash within an equilateral triangle is intended to alert the user to the presence of uninsulated dangerous voltage within the device that may be sufficient enough to constitute a risk of electric shock to users.



The exclamation mark within an equilateral triangle is intended to alert the user to the presence of important operating and maintenance instructions in the literature accompanying the product.

1. Read these instructions.
2. Keep these instructions.
3. Heed all warnings.
4. Follow all instructions.
5. Do not use this apparatus near water.
6. Clean only with dry cloth.
7. Do not block any ventilation openings. Install in accordance with the manufacturer's instructions.
8. Do not install near any heat sources such as radiators, heat registers, stoves, or other apparatus (including amplifiers) that produce heat.
9. Do not defeat the safety purpose of the polarized or grounding-type plug. A polarized plug has two blades with one wider than the other. A grounding type plug has two blades and a third grounding prong. The wide blade or the third prong are provided for your safety. If the provided plug does not fit into your outlet, consult an electrician for replacement of the obsolete outlet.
10. Protect the power cord from being walked on or pinched particularly at plugs, convenience receptacles, and the point where they exit from the apparatus.
11. Only use attachments/accessories specified by the manufacturer.
12. Use only with the cart, stand, tripod, bracket, or table specified by the manufacturer, or sold with the apparatus. When a cart is used, use caution when moving the cart/apparatus combination to avoid injury from tip-over.
13. Unplug this apparatus during lightning storms or when unused for long periods of time.
14. Refer all servicing to qualified service personnel. Servicing is required when the apparatus has been damaged in any way, such as power supply cord or plug is damaged, liquid has been spilled or objects have fallen into the apparatus, the apparatus has been exposed to rain or moisture, does not operate normally, or has been dropped.

Exemption from liability

- beyerdynamic GmbH & Co. KG will not be liable if any damage, injury or accident occurs due to negligent, incorrect or inappropriate operation of the product.

Location

- The equipment must be set up so that the mains switch, mains plug and all connections on the rear of the device are easily accessible.
- If you transport the equipment to another location take care to ensure that it is adequately secured and can never be damaged by being dropped or by impacts on the equipment.

Fire hazard

- Never place naked flames (e.g. candles) near the equipment.

Humidity / heat sources

- Never expose the equipment to rain or a high level of humidity. For this reason do not install it in the immediate vicinity of swimming pools, showers, damp basement rooms or other areas with unusually high atmospheric humidity.
- Never place objects containing liquid (e.g. vases or drinking glasses) on the equipment. Liquids in the equipment could cause a short circuit.
- Do not install near any heat sources such as radiators, heat registers, stoves or other apparatus (including amplifiers) that produce heat.

Ventilation

- This equipment needs adequate ventilation. Do not cover ventilation grilles. If the heat it generates cannot be dissipated, the equipment could be damaged or flammable materials in its immediate vicinity could be ignited. Take care to ensure that the air can circulate freely through the ventilation grilles and keep flammable materials away.
- Do not insert objects into the ventilation grilles or other openings. You could damage the equipment and/or injure yourself.

Connection

- The equipment must be connected to a mains socket that has an earth contact.
- Protect the power cord from being walked on or pinched particularly at plugs, convenience receptacles, and the point where they exit from the apparatus.
- Lay all connection cables so that they do not present a trip hazard.
- Whenever working on the equipment switch off all inputs and outputs to the power supply.
- Check whether the connection figures comply with the existing mains supply. Serious damage could occur due to connecting the system to the wrong power supply. An incorrect mains voltage could damage the equipment or cause an electric shock.
- Please note that different operating voltages require the use of different types of power cable and plugs.

Please refer to the following table:

Voltage	Power plug according to standard
110 - 125 V	UL817 and CSA C 22.2 no 42.
220 - 230 V	CEE 7 page VII, SR section 107-2-D1/IEC 83 page C4.
240 V	BS 1363 (1984): "Specification for 13A fused plugs and switched and un-switched socket outlets."

- If the equipment causes a blown fuse or a short circuit, disconnect it from the mains and have it checked and repaired.
- Do not hold the mains cable with wet hands. There must be no water or dust on the contact pins. In both cases you could receive an electric shock.

- The mains cable must be firmly connected. If it is loose there is a fire hazard.
- Always pull out the mains cable from the mains and/or from the equipment by the plug – never by the cable. The cable could be damaged and cause an electric shock or fire.
- Do not use the equipment if the mains plug is damaged.
- If you connect defective or unsuitable accessories, the equipment could be damaged. Only use connection cables available from or recommended by beyerdynamic. If you use cables you have made up yourself, all claim to warranty is null and void.

Maintenance

- Only clean the equipment with a slightly damp or dry cloth. Never use solvents as these damage the surface.

Troubleshooting and servicing

- Do not open the equipment without authorisation. You could receive an electric shock. There are no user-serviceable parts inside.
- Leave all service work to authorised expert personnel.

1.2 S 600 / TS 600 transmitters

- Protect the transmitter from moisture and sudden impacts. You could either injure yourself or others or damage the transmitter.
- Do not blow into the microphone. In a condenser microphone this could damage the transformer. It is preferable to carry out a speech trial.
- Clip-on microphones are often very compact. If they are accidentally swallowed there is a risk of choking. Always keep this type of microphone away from small children.
- Always switch off the transmitter before charging or changing the battery.
- The normal commercial alkaline batteries can have a length tolerance of 2 - 3 mm. When changing the battery always ensure good contact.
- From time to time the battery contacts should be cleaned with a soft cloth moistened with spirits or alcohol.
- If the transmitter is not being used for weeks or months, please remove the batteries. Batteries can leak when not being used for a long time and corrode the conductor strips and components. Repair is not then possible. In this case all warranty claims are null and void. The description "leak proof" on batteries is no guarantee that they will not run out.
- Never take batteries apart yourself. The battery acid contained will damage skin and clothing.

1.3 Disposal

- This symbol on the product, in the instructions or on the packaging means that your electrical and electronic equipment should be disposed at the end of its life separately from your household waste. There are separate collection systems for recycling in the EU. For more information, please contact the local authority or your retailer where you purchased the product.
- Make sure to dispose of used batteries as required by local waste disposal rules. Never throw batteries into a fire (risk of explosion) or dustbin.
- When scrapping the equipment, remove the batteries, separate the case, circuit boards, and cables, and dispose of all components in accordance with local waste disposal rules.



FCC ID: OSDS600 for S 600

FCC ID: OSDTS600 for TS 600

Canada: IC: 3628A-S600 for S 600

Canada: IC: 3628A-TS600 for TS 600

Canada: IC: 3628A-OPUS600 for NE 600 S and NE 600 D

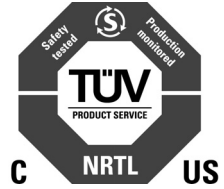

NOTE: This equipment has been tested and found to comply with the limits for a Class B digital device, pursuant to Part 15 of the FCC Rules. These limits are designed to provide reasonable protection against harmful interference in a residential installation. This equipment generates, uses and can radiate radio frequency energy and, if not installed and used in accordance with the instructions, may cause harmful interference to radio communications. However, there is no guarantee that interference will not occur in a particular installation. If this equipment does cause harmful interference to radio or television reception, which can be determined by turning the equipment off and on, the user is encouraged to try to correct the interference by one or more of the following measures:

- Reorient or relocate the receiving antenna.
- Increase the separation between the equipment and receiver.
- Connect the equipment into an outlet on a circuit different from that to which the receiver is connected.
- Consult the dealer or an experienced radio/TV technician for help.

NOTICE:

Changes or modifications made to this equipment not expressly approved by beyerdynamic GmbH & Co. KG may void the FCC authorization to operate this equipment.

NOTICE:

This device complies with Part 15 of the FCC Rules and with RSS-210 of Industry Canada.

Operation is subject to the following two conditions:

- (1) this device may not cause harmful interference, and
- (2) this device must accept any interference received, including interference that may cause undesired operation.

NOTICE:

This Class B digital apparatus complies with Canadian ICES-003.

Cet appareil numérique de la classe B est conforme à la norme NMB-003 du Canada.

2. NE 600 diversity receiver

2.1 Controls and indicators

Front view – NE 600 S

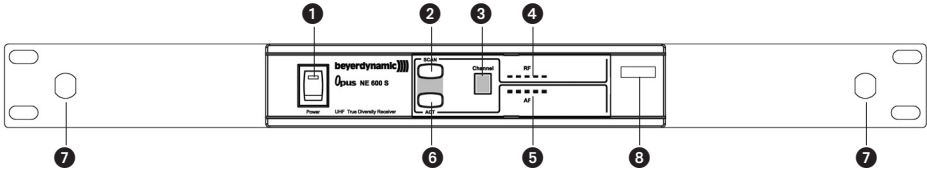

Front view – NE 600 D

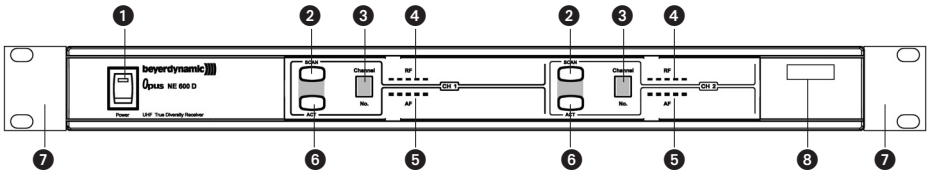

- ❶ On-off switch with LED indicator
- ❷ Scan button
- ❸ Channel indicator
- ❹ RF level indicator
- ❺ AF level indicator
- ❻ ACT button
- ❼ 19" rack mounting bracket (optional accessory)
NE 600 S only: with holes to mount the antennae on the front
- ❽ Sticker indicating the frequency range

Rear view – NE 600 S

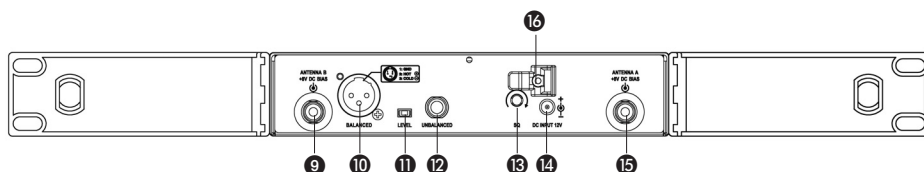

Rear view – NE 600 D

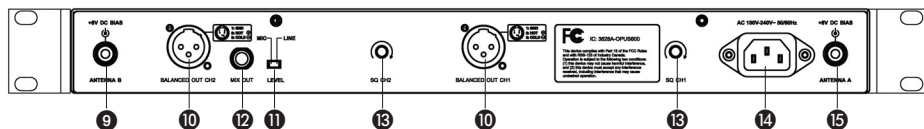

- 9 Antenna input B. TNC socket. With power supply for antenna amplifier.
- 10 Audio output, 3-pin XLR, balanced
- 11 Mic/Line level switch for audio output 10 and 12. "Mic" for microphone level, "Line" for Line out level
- 12 Audio output, 1/4" jack (6.35 mm), unbalanced
- 13 Variable squelch control
- 14 **NE 600 S:** DC connection for power supply unit, 12 V DC
NE 600 D: Power connection, 100 - 240 volts AC
- 15 Antenna input A. TNC socket. With power supply for antenna amplifier.
- 16 Cable holder for strain relief of the power cable

2.2 How to connect the antennae

Connect the antennae to the TNC sockets 9 and 15 and set them at an angle (60°).

Please note that for diversity operation both antennae have to be connected. A weighting circuit silently switches the signal with the better S/N ratio to the output.

Important:

Avoid obstacles between antennae and transmitter; otherwise the reception could be disturbed.

2.3 Where to place the receiver

- Place the diversity receiver in the same room or area as the transmitters. Make sure the diversity receiver is placed as close as possible to the transmitter.
- Ensure that the NE 600 is installed as close as possible to the mixing console or amplifier so that the display can be seen at all times.
- Do not place the diversity receiver near digitally controlled equipment.

2.4 Connections

- Connect the Audio output to the corresponding input of the mixing console or amplifier. Use the **balanced Audio output 10**, when you connect the receiver to a mixer/amplifier with a balanced input.
- Use the **unbalanced Audio output 12**, when you connect the receiver to the "LINE" input of an instrument amplifier.
- Make sure the Mic/Line level switch 11 is switched to the correct position. Switch to **"LINE"**, when you connect the receiver to a mixer/amplifier. When connecting to a guitar amplifier you should choose "LINE", or the volume may be too low. Switch to **"MIC-IN"**, when you connect the receiver to a microphone input. Incorrect positioning of the Mic/Line level switch 11 can cause distortion.
- Make sure the mains voltage shown on the power supply unit corresponds to the local mains voltage.
- Connect the power supply unit 14 to the receiver or the power cable to the power connection 14 and to AC mains power.

NE 600 S

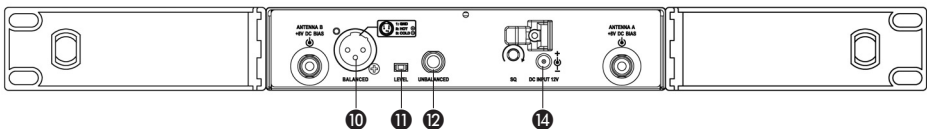

NE 600 D

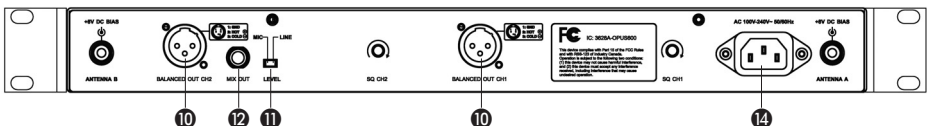

- Thread the power cable through the cable grip as shown on the illustration. The cable grip prevents the connector from being pulled off by accident.

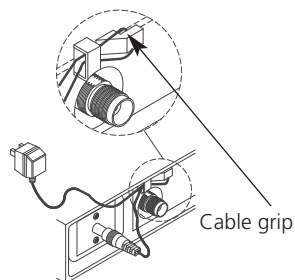

2.5 How to operate the receiver

- Switch on the receiver ❶. The red LED will illuminate.
- As soon as you switch on the transmitter, the RF indicator ❷ will illuminate. When you speak into the microphone, the AF indicator ❸ will illuminate according to the strength of the sound level. If the LED does not illuminate or there is no sound, the system should be rechecked.
- The microphone output level has to be adjusted at the amplifier or mixer.

2.6 How to adjust the squelch

- Due to the Pilotone and NoiseLock features static noise should not occur.
- If the RF indicator ❷ illuminates before the transmitter is switched on, noise will occur. The more LEDs illuminate, the stronger the interference.
- In this case the interference can be suppressed with the squelch control ❶ by rotating it clockwise to the right.
- Please note, adjusting the squelch can affect the sensitivity of the receiver and the distance between transmitter and receiver antenna may need to be reduced.
- If the interferences cannot be suppressed with the squelch control, you should select a different frequency (refer also to chapter 2.7 *Channel / frequency selection*).

NE 600 S / D

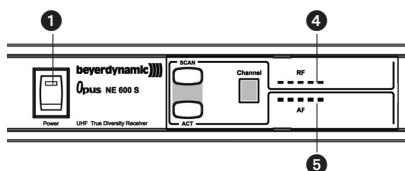

NE 600 S / D

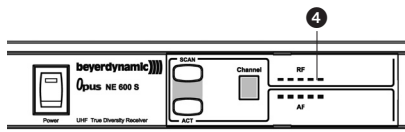

NE 600 S

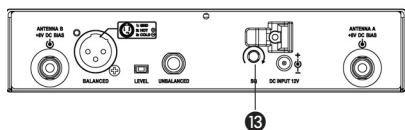

NE 600 D

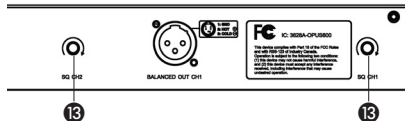

2.7 Channel / frequency selection

- The NE 600 provides 16 adjustable frequencies.
- If you want to change the selected frequency, press the Scan button **2** until the channel indicator **3** will flash. Press the "Scan" button **2** once again so that the receiver will search for an interference-free frequency automatically.
- The frequency will be displayed as number or letter **3**.

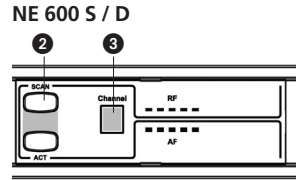

2.8 How to transmit the frequency to the transmitter / ACT function

- Using the "ACT" button **6** the frequency of the receiver will be transmitted to the transmitter.
- Press the "ACT" button **6** and hold the switched on transmitter with the "ACT" mark or infra red point in front of the infrared diode between the "ACT" and "Scan" button.
- As soon as the frequency has been transmitted to the transmitter, the "ACT" function will be finished automatically.

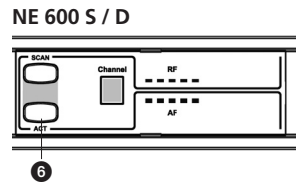

2.9 How to install the receiver into a 19" rack

NE 600 S one channel receiver

- To install the receiver into a 19" rack mount the optional FB 71 mounting bracket to the right and left hand side of the receiver.
- If you would like to install two NE 600 S receivers into a 19" rack, mount connecting plates between the top and bottom of the two receivers and the FB 72 mounting bracket to the right and left hand side of the receiver.

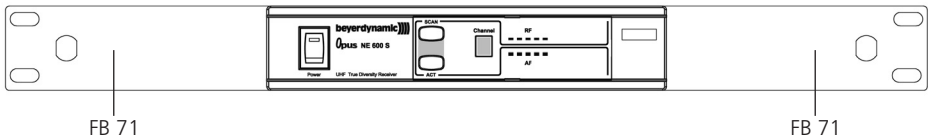

NE 600 D dual channel receiver

- To install the receiver into a 19" rack mount the optional FB 72 mounting bracket to the right and left hand side of the receiver.

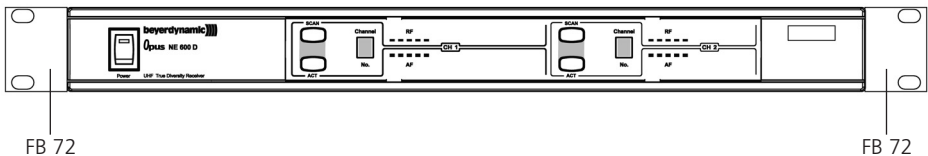

2.10 How to connect and position remote antennae

In multichannel systems we recommend the use of the AT 70 A/B UHF antenna set consisting of antennae, cables, antenna boosters and mounting kit.

1. Connect the receiving antennae to the corresponding antenna inputs and place the antennae to the right and left of the receiver. Diversity reception is improved when the antennae are vertical or slightly tilted.
2. The distance between the two receiving antennae should be at least 1 m.

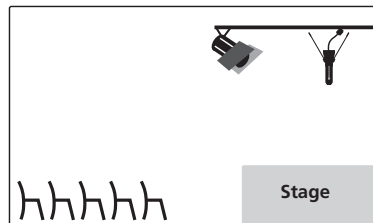
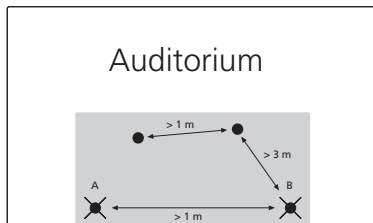

3. The distance between transmitting and receiving antennae should be at least 3 m to avoid overloading and interference between different channels. We therefore recommend installing the antennae in a high position, especially in multi-channel systems.

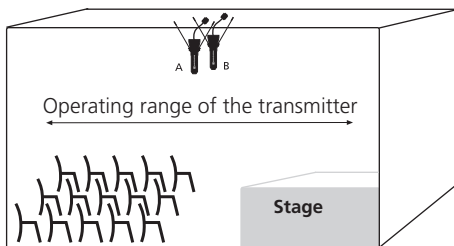

4. If the operating range of the transmitters is greater than the stage, the antennae can be mounted vertically on the ceiling. The distance between the two receiving antennae should be approximately half the total operating range.

Please note:

1. Install the receiving antennae in the same area as the transmitter.
2. To avoid interference do not install the antennae near digitally controlled components.
3. Keep a minimum distance of 0.5 m from metallic objects, including reinforced concrete walls or pillars.
4. Do not bend the antenna cables at the antenna input, and ensure that they are not subjected to undue stress.

2.11 ZAS 800 antenna splitter

2.11.1 Controls and indicators

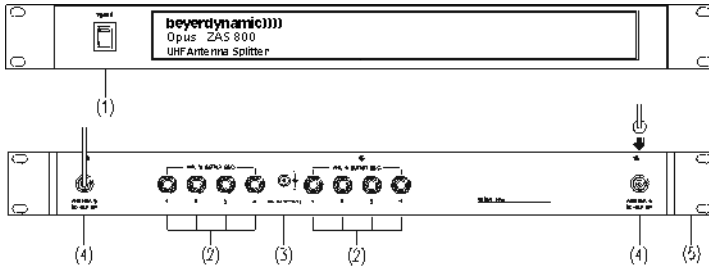

- ❶ On-off switch and power on LED. When the antenna splitter is switched on, the red LED will illuminate.
- ❷ Outputs to connect the receivers
- ❸ DC-connection to connect the DC power supply unit (12 V)
- ❹ Antenna sockets A/B. DC-Out: 8 V / 170 mA
- ❺ Mounting brackets for 19" rack mounting

2.11.2 Installation

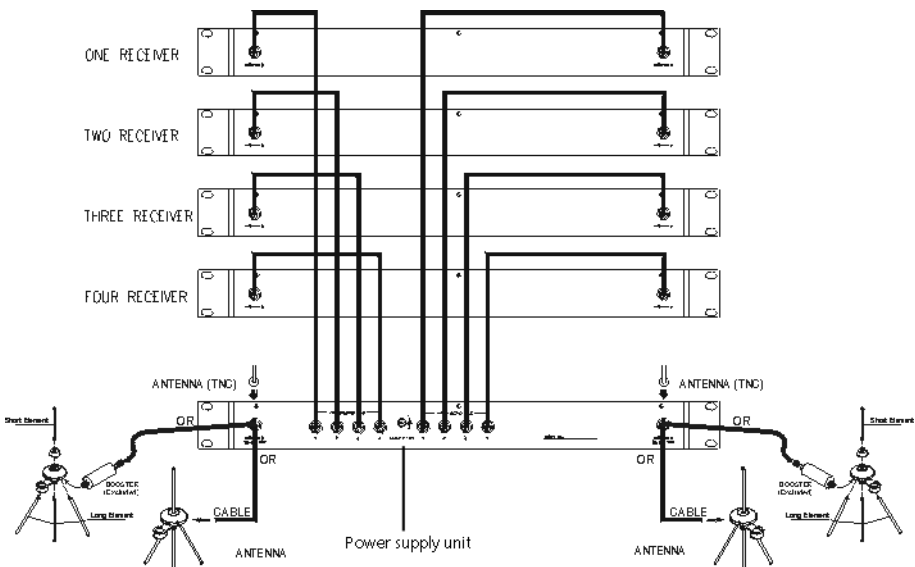

1. Mount the ZAS 800 antenna splitter and the NE 600 receivers into a 19" rack by using the mounting brackets.
2. Connect the supplied antennae to the antenna sockets A/B **4**. You can also use optional remote antennae. For mounting the antennae on the front use the optional FB 30 mounting bracket.
3. Connect the NE 600 receivers to the ZAS 800 antenna splitter with the supplied cables.
4. Connect the power supply unit to the DC-connection **3** and to AC power. (**Caution:** Make sure that the indicated voltage corresponds to the local voltage.)
5. Switch on the ZAS 800 antenna splitter **1**.

2.11.3 General information

1. The antenna sockets **4** have a voltage of 8 V DC. To avoid a short circuit the sockets must not touch the rack housing.
2. For the connection of remote antennae use usual 50 Ω coaxial cables. The longer the cable, the higher the RF signal loss. Therefore, the cable length should not exceed 6 m.
The larger the diameter of cable, the lower the signal loss. If you need cables longer than 6 m you should therefore use cables with a larger diameter to reduce the loss of signal.
3. Use 50 Ω coaxial cables to connect the NE 600 receivers to the ZAS 800 antenna splitter. The distance between these devices should be as short as possible. We recommend using the supplied cables.
4. Supplied accessories:
8 x RG 58 AU cables, 40 cm (TNC)
1 pair FB 30 rack mount brackets (incl. front mounting option)
1 x power supply unit

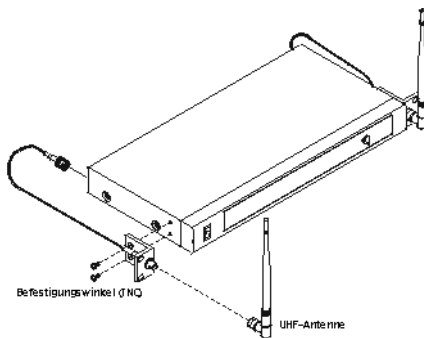

3. S 600 handheld transmitter

3.1 Controls and indicators

There are different condenser and dynamic microphone capsules for the handheld transmitter (refer to chapter 10. *Optional accessories*).

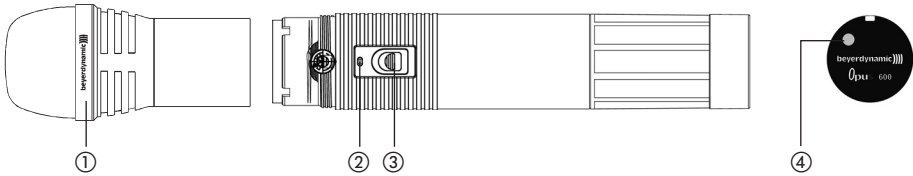

- ① Microphone capsule (can be unscrewed)
- ② Battery status indicator
- ③ On-off switch
- ④ Infrared diode (at the bottom of the transmitter)

3.2 How to insert the batteries / rechargeable batteries

1. Unscrew the battery cap counter-clockwise.
2. Insert two 1.5 V batteries (AA) or fully charged NiMH batteries into the battery compartment observing the polarity markings.
3. The battery status indicator ② should flash for a moment. If the battery status indicator ② does not flash, the battery is not inserted correctly or empty. Insert the battery correctly or replace it.

S 600

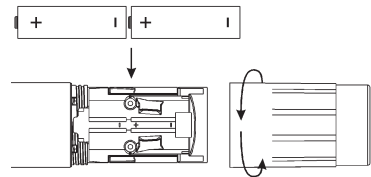

3.3 How to operate the handheld transmitter

1. When the microphone is switched on, the battery status indicator ② will flash for a moment.
2. As soon as an audio signal is transmitted, the AF meter on the receiver will display a signal.
3. When you do not use the microphone, make sure it is switched off. If you do not use the microphone for several weeks or months, please remove the battery as it can leak after some time and damage parts of the transmitter.
4. The battery status indicator ② will not illuminate, when the frequency is transmitted via the ACT function to the transmitter. If the battery status indicator ② will flash, transmitter and receiver do not operate with the same frequency. Make sure that transmitter and receiver operate with the same frequency (refer to type plate).

3.4 How to change the microphone capsule

There are different microphone capsules available for the handheld transmitter. If you want to change the microphone capsule, turn it anti-clockwise to unscrew it from the transmitter. Put the selected microphone capsule onto the transmitter and turn it clockwise to tighten.

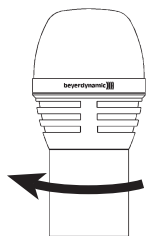

DM 960

Hypercardioid dynamic microphone capsule. Suitable for vocal and broadcasting applications. Weight 191 g.

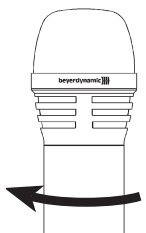

DM 969

Supercardioid dynamic microphone capsule. Suitable for vocals. Weight 131 g.

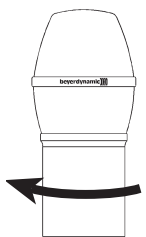

EM 981

Cardioid electret condenser microphone capsule for solo vocals, conferences and speech. Weight 191 g.

3.5 How to set the low-cut filter

- The EM 981 microphone capsule features a low-cut filter to compensate the close-miking effect which usually occurs with directional microphones. To set the low-cut filter unscrew the complete microphone head with the upper shaft as indicated by the arrows.
- At the bottom of the microphone head you can set the low-cut filter.
- **Standard setting: linear (position Lin)**

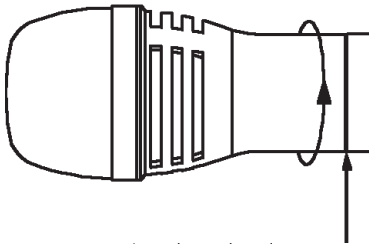

Unscrew microphone head

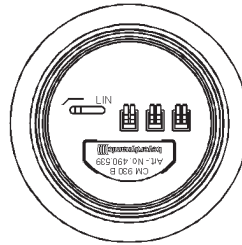

Set low-cut filter

3.6 Maintenance

- Protect the handheld transmitter from humidity, knocks and shock. Avoid dropping the transmitter at all times.
- For cleaning metal surfaces, use a soft cloth moistened with methylated spirits or alcohol.
- As soon as your microphone sounds dull, you should clean the integrated pop shield. Proceed as described in the following.



DM 960

- Unscrew the upper part of the microphone basket (turn anti-clockwise).
- Clean it under clear water.
- Let the pop shield dry overnight before you replace it.
- The upper part of the microphone basket **cannot** be cleaned in a dishwasher.

**DM 969**

- Unscrew the upper part of the microphone basket (turn anti-clockwise).
- Pull out the foam pop shield and clean it under clear running water.
- If necessary, use a mild washing-up liquid.
- Dry it afterwards with a hairdryer or allow it to dry overnight.
- Place the dry pop shield inside the microphone basket and replace the microphone basket by screwing it on clockwise.

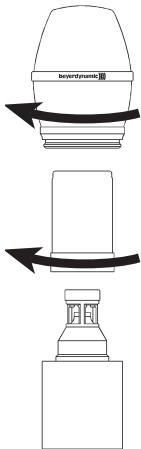
**EM 981**

- Unscrew the microphone capsule (turn anti-clockwise).
- Unscrew the wire mesh pop shield (turn anti-clockwise).
- Clean the pop shield under clear running water.
- Allow the pop shield to dry overnight before you replace it.
- The wire mesh pop shield **cannot** be cleaned in a dishwasher.

4. TS 600 beltpack transmitter

4.1 Controls and indicators

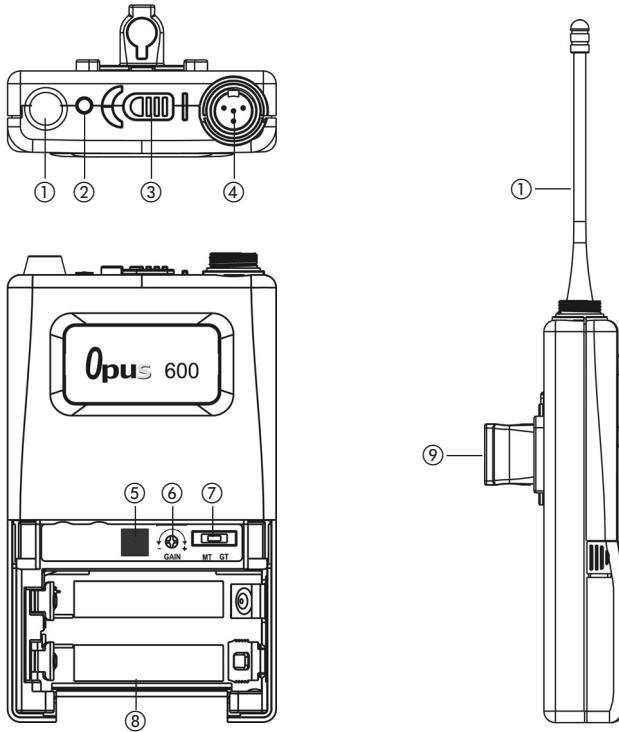

- ① Transmitting antenna.
- ② Battery status LED to indicate the power on-off and battery status.
 - (a) When the beltpack transmitter is switched on this LED will flash for a moment to indicate the normal battery status.
 - (b) When the LED stays red after having switched on the transmitter the battery is too weak and must be replaced.
- ③ On-off switch (ON = switch to "ON"-position; OFF = switch to "OFF"-position). Switch off the transmitter when not in use.
- ④ AF input, 4-pin mini XLR for microphones (lavalier, neckworn mics). For connection please refer to chapter 4.5 *AF Connection*.
- ⑤ Infrared receiving diode for ACT function.
- ⑥ Gain control to adjust input gain.

- ⑦ GT/MT switch: When you use electric guitars this switch must be in the "GT" position. In the GT mode the gain control is deactivated. Switch to the "MT" position when you use condenser and wired microphones. In the MT mode the gain control is activated.
- ⑧ Battery compartment and cover for two 1.5 V batteries (AA) or rechargeable NiMH batteries.
- ⑨ Removable belt clip. To remove use a screwdriver at a 45° angle.

This is how to remove the belt clip

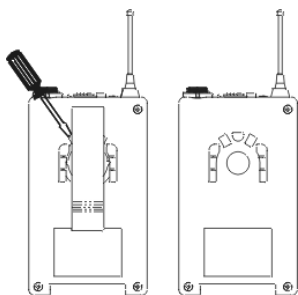

4.2 How to insert the batteries / rechargeable batteries

1. Push down the two snap locks on the right and left of the battery compartment and open it. Remove the batteries. Refer to Fig. 1.
2. Insert two 1.5 V batteries (AA) or rechargeable NiMH batteries into the battery compartment observing the polarity markings. Refer to Fig. 2. Then close the battery compartment again.

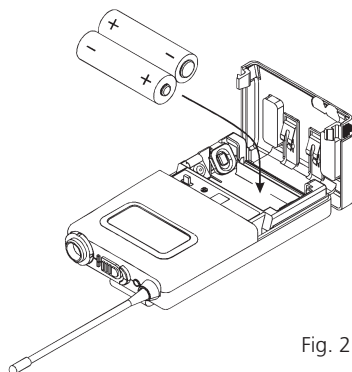
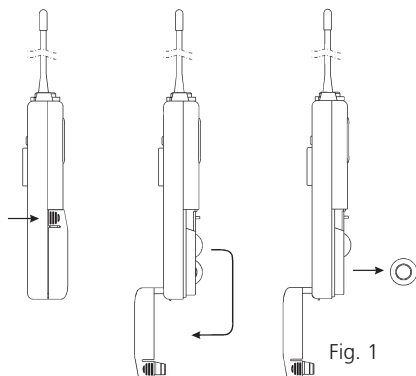

4.3 How to operate the beltpack transmitter

1. Push down the two snap locks on the right and left of the battery compartment and open it. Now you can adjust the GT/MT switch ⑦ and the gain control ⑥.
2. Make sure that the transmitter and receiver are on the same frequency.
3. The battery status LED ② will flash for a moment when the transmitter is switched on and indicates the normal battery status. When the LED fails to flash, there is no battery inserted, the battery is leaking or inserted incorrectly.
4. Connect the microphone or instrument to the input socket ④ and fasten the plug by turning clockwise. Refer to illustration below.

Important:

The LED ② does not illuminate when the frequency is transmitted to the transmitter via ACT function. If the LED ② illuminates, however, the frequency bands of transmitter and receiver do not correspond to each other. Please check, if transmitter and receiver work in the same frequency band (see type plate).

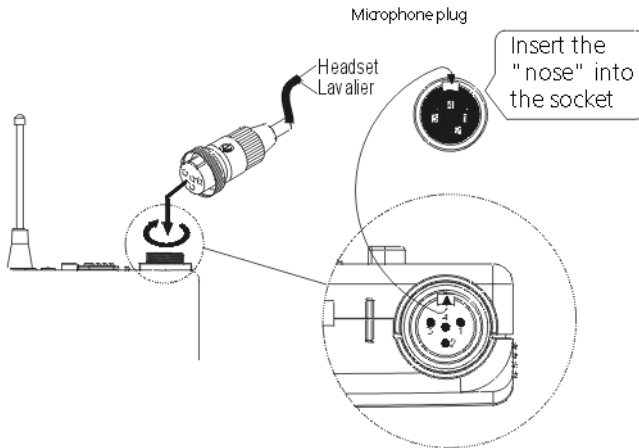

4.4 Adjusting the input gain

1. Switch on the TS 600 beltpack transmitter with the on-off switch ③. Turn the gain control ⑥ fully anti-clockwise to minimum gain.
2. Speak into the microphone at the maximum level you expect to use. We recommend you use the letter "U" as a spoken "U" has a relatively good sine wave shape. Adjust the gain control ⑥ to the desired gain. On the NE 600 receiver the AF level must not show any clipping. When miking instruments, play at the maximum level you expect to use.

4.5 AF connection

- (1) 2-wire electret condenser microphone capsule

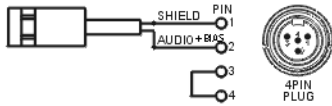

e.g. MCE 5.18,
MCE 10.18,
MCE 60.18

- (2) 3-wire electret condenser microphone capsule

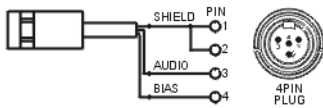

e.g. Opus 54.18,
Opus 55.18 Mk II

- (3) Dynamic microphone

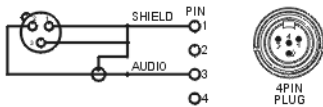

- (4) Electric guitar

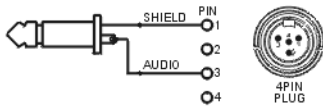

- (5) Line-in (impedance $8\ \Omega$, attenuation 10 dB)

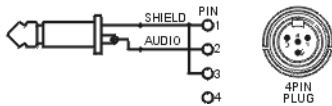

5. General instructions for all transmitters

5.1 Battery change

- Switch the transmitter off before changing the battery.
- If you do not use the transmitter for several weeks or months, please remove the battery as it can leak after some time and damage parts of the transmitter. Even "leak proof" may leak after some time. Damage caused by leaking batteries is not covered under warranty.
- Clean the battery contacts from time to time.
- Please do not throw used battery packs away with your household rubbish, but take them to your local collection points.
- When using rechargeable batteries use conventional chargers.

5.2 Before the soundcheck

1. Check the transmitter battery and replace or recharge it if necessary. Use fresh alkaline batteries only.
2. When the transmitter is switched off and immediately switched on again, it is possible that the transmitter remains switched off. The cause is the function that allows to switch the transmitter on / off silently. Should this problem occur during operation, the battery might have contact problems. After switching off the transmitter you should wait at least 1 second, until you switch the transmitter on again.
3. Check the performance area for dropouts. If you find any dropouts, try to eliminate them by repositioning the antennae or the receiver.
4. The receiving antennae should be placed so that the distance between receiving antennae and transmitter is at least 3 m. If necessary, use remote antennae (AT 707 A/B).
5. To avoid popping try holding the microphone at a slight angle below the mouth.

5.3 Positioning of transmitters if interference occurs

Put all transmitters in their position and switch them on. Switch each transmitter off one at a time and check the receiver for interference in the corresponding channel.

The interference is possibly eliminated by changing the squelch (refer also to chapter 2.6 *How to adjust the squelch*).

When using multi-channel-systems, please contact beyerdynamic. Interferences can also be caused by DVB-T / DVB-H signals or signals of other applications in the UHF range in the neighbourhood.

5.4 What to do to avoid feedback

Feedback is caused by your microphone getting too close to a loudspeaker.

We recommend:

- Move away from the loudspeaker.
- Turn the microphone away from the loudspeaker.

6. Trouble shooting

6.1 NE 600 diversity receiver

Problem	Possible Cause	Solution
No function	<ul style="list-style-type: none"> Power supply is interrupted, receiver is not connected to the mains 	<ul style="list-style-type: none"> Connect the receiver to AC power
No reception	<ul style="list-style-type: none"> Transmitter is not switched on Transmitter works on a different frequency Defect in the antenna cables with remote antennae 	<ul style="list-style-type: none"> Switch on the transmitter Adjust the correct frequency with the ACT function Check the antenna cables
Distorted sound	<ul style="list-style-type: none"> Input amplifier of the connected mixer is overloaded 	<ul style="list-style-type: none"> Use the gain control of the mixer or adjust the volume
No sound, RF indication is okay, AF indication is missing during modulation	<ul style="list-style-type: none"> Wrong indication caused by strong interference signals No microphone connected to TS 600 beltpack transmitter 	<ul style="list-style-type: none"> Select another frequency Connect a suitable microphone

6.2 Handheld and beltpack transmitter

Problem	Possible Cause	Solution
No function	<ul style="list-style-type: none"> Transmitter and receiver have different frequencies Insufficient battery voltage Poor battery contact, batteries inserted incorrectly 	<ul style="list-style-type: none"> Check if transmitter and receiver have the same frequency Replace the batteries or recharge them, if you use rechargeable batteries Check the batteries and insert them again
No RF indication at the receiver	<ul style="list-style-type: none"> Transmission distance between transmitter and receiver is too great 	<ul style="list-style-type: none"> Reduce the distance between transmitter and receiver
Noise/chirping	<ul style="list-style-type: none"> Interference from other transmitters Two transmitters are on the same frequency Battery of the transmitter is too weak 	<ul style="list-style-type: none"> Switch off the other transmitters Change the frequency of one transmitter Replace the batteries or recharge them

7. Maintenance

In the unlikely event of equipment failure, the product should be returned to your beyerdynamic dealer. Unauthorised attempts at repair may invalidate the warranty.

8. Licensing

In most countries around the world, wireless systems must be approved for use by the authorities and it may be necessary to obtain a licence to use it legally. Your local beyerdynamic dealer will be able to give you details on wireless system regulations for your area.

The components of the Opus 600 system are approved according to the directive R&TTE 99/5/EEC:
TS 600
SDM 660, SDM 669, SEM 681

under the CE 0682 ⓘ identification

Licensing Information for the USA

Licensing: A ministerial license to operate this equipment may be required in certain areas. Consult your national authority for possible requirements. Changes or modifications not expressly approved could void your authority to operate the equipment. Licensing of wireless microphone equipment is the user's responsibility, and licensability depends on the user's classification and application, and on the selected frequency. The user is strongly urged to contact the appropriate telecommunications authority concerning proper licensing, and before choosing and ordering frequencies.

9. Components

The following components are available as sets or individual components in the frequency range 506 - 530 MHz, 668 - 692 MHz, 774 - 798 MHz*, 790 - 814 MHz** or 841 - 865 MHz**:

NE 600 S	UHF true diversity receiver, one channel, 9.5" metal housing, 1 HU, PLL synthesizer, Pilotone, LED indicators, ACT and SCAN functions, 16 pre-programmed frequencies, incl. mounting brackets, external power supply unit
NE 600 D	UHF true diversity receiver, dual channel, 19" metal housing, 1 HU, PLL synthesizer, Pilotone, LED indicators, ACT and SCAN functions, 16 pre-programmed frequencies, incl. mounting brackets, and cables to mount the antennae on the front
S 600	UHF handheld transmitter, without microphone capsule, plastic housing, battery low LED, ACT function, incl. 2 x AA batteries
TS 600	UHF beltpack transmitter, without microphone, plastic housing, battery low LED, ACT function, incl. 2 x AA batteries

***NOT for use in the USA **NOT for use in the USA or Canada**

10. Optional accessories

NE 600 diversity receiver

Antenna splitter

ZAS 800	Antenna splitter, active, 19" housing, incl. connecting cables, 506 - 530 MHz.	Order # 497.045
ZAS 800	same as above, but 668 - 692 MHz.	Order # 491.551
ZAS 800	same as above, but 774 - 798 MHz*.	Order # 473.081
ZAS 800	same as above, but 790 - 814 MHz**.	Order # 491.667
ZAS 800	same as above, but 841 - 865 MHz**.	Order # 491.675

Antennae

AT 70 A/B Set	UHF antenna set for NE 600, incl. 2 x AT 70 B TNC booster, 2 x AT 70 TNC antenna and 2 x MS 10 mounting kit.	Order # 459.976
FBC 71	Cable rear-to-front for NE 600 and ZAS 800	Order # 469.823
FB 71	Mounting bracket, metal, for mounting one NE 600 S receiver into a 19" rack, 1 HU	Order # 469.793
FB 72	Mounting bracket, metal, for mounting two NE 600 S receivers or one NE 600 D receiver into a 19" rack, 1 HU	Order # 469.807

S 600 handheld transmitter

Microphone capsules

DM 960 B	Dynamic, hypercardioid, black	Order # 490.490
DM 960 S	Dynamic, hypercardioid, silver	Order # 490.504
DM 969 S	Dynamic, supercardioid, silver	Order # 490.512
EM 981 S	Electret condenser, cardioid, silver.	Order # 490.520

TS 600 beltpack transmitter

Microphones

MCE 5.18	Condenser clip-on microphone, omnidirectional, black.	Order # 471.879
MCE 10.18	Condenser clip-on microphone, cardioid, black.	Order # 471.895
MCE 60.18	Condenser clip-on microphone, omnidirectional, black.	Order # 469.548
Opus 54.18 BLK	Neckworn microphone, condenser, cardioid, black	Order # 464.945
Opus 54.18 SC	Neckworn microphone, condenser, cardioid, beige	Order # 474.223
Opus 55.18 MkII BLK	Neckworn microphone, condenser, omnidirectional, black	Order # 475.394
Opus 55.18 MkII SC	Neckworn microphone, condenser, omnidirectional, beige	Order # 475.386
TG-X 54.18 BLK	Neckworn microphone, condenser, cardioid, black	Order # 700.061
TG-X 54.18 SC	Neckworn microphone, condenser, cardioid, beige	Order # 700.053
TG-X 55.18 BLK	Neckworn microphone, condenser, omnidirectional, black	Order # 700.069
TG-X 55.18 SC	Neckworn microphone, condenser, omnidirectional, beige	Order # 700.088

Cable

MJ 41 G	Instrument cable, 1/4" jack (6.35 mm) for TS 600.	Order # 460.087
---------	---	-----------------

***NOT for use in the USA **NOT for use in the USA or Canada**

11. Technical specifications

NE 600 diversity receiver

Operating principle	True diversity receiver (UHF)
Frequency range	506 - 530 MHz 668 - 692 MHz 774 - 798 MHz* 790 - 814 MHz** 841 - 865 MHz**
Power consumption	NE 600 S: 6 W NE 600 D: 15 W
Power consumption in stand-by mode	NE 600 S: 1.5 W NE 600 D: 2.5 W
Switching bandwidth	24 MHz
Sensitivity	2 μ V
Antenna connection	2 x TNC
Nominal deviation	\pm 40 kHz
Output level	1.2 V
Comander system	NE572
Signal-to-noise ratio	> 110 dB(A)
T.H.D.	< 0.5% at 1 kHz
Squelch	2 μ V - 1 mV, adjustable
Power supply	12 V - 15 V DC
Mains	100 V - 240 V AC
Dimensions	NE 600 S (L x B x H) 210 x 235 x 43 mm NE 600 D (L x B x H) 420 x 204 x 44 mm
Weight	NE 600 S 1.1 kg (without power supply unit) NE 600 D 2.2 kg
Minimum distance of the profiles when mounting into a 19" rack	446 mm

SDM 660 / SDM 669 / SEM 681 handheld transmitter

Polar pattern	Hypercardioid (SDM 660) Supercardioid (SDM 669) Cardioid (SEM 681)
Transducer type	Dynamic (SDM 660, SDM 669) Electret condenser (SEM 681)
Frequency range	506 - 530 MHz 668 - 692 MHz 774 - 798 MHz* 790 - 814 MHz** 841 - 865 MHz**
Modulation	FM
Nominal deviation	\pm 40 kHz
Radiated transmitter power	10 mW
Comander system	NE572

***NOT for use in the USA **NOT for use in the USA or Canada**

Max. SPL	146 dB
AF transmission range	
SDM 660	55 - 18,000 Hz (close miking 2 cm) at 80 dB SPL
SDM 669	65 - 16,000 Hz (close miking 2 cm) at 80 dB SPL
SEM 681	50 - 18,000 Hz (close miking 2 cm) at 80 dB SPL
Rear attenuation	-20 dB at 1 kHz / 120° (SDM 660) -15 dB at 1 kHz / 145° (SDM 669) -15 dB at 1 kHz / 180° (SEM 681)
Signal-to-noise ratio	> 110 dB
T.H.D.	< 0.5% at 1 kHz
Transmission range	100 m
Power supply	2 x 1.5 V batteries (AA)
Current consumption	approx. 85 mA
Operating time	> 20 hours with alkaline batteries
Dimensions	
Length S 600	188 mm
Shaftø S 600	38 mm
Weight with batteries	163 g

TS 600 beltpack transmitter

Frequency range	506 - 530 MHz 668 - 692 MHz 774 - 798 MHz* 790 - 814 MHz** 841 - 865 MHz**
Modulation	FM
Nominal deviation	± 40 kHz
Radiated transmitter power	20 mW
Companion system	NE572
Signal-to-noise ratio	> 110 dB
T.H.D.	< 0.5% at 1 kHz
Frequency response	50 Hz - 18,000 Hz
Gain	10 mV - 0.3 V adjustable, at nominal deviation
Power supply	2 x 1.5 V batteries (AA)
Current consumption	approx. 85 mA
Operating time	> 20 hours with alkaline batteries
Dimensions (L x W x D)	110 x 63 x 21.5 mm
Weight with batteries	145 g
4-pin connection	Pin 1 = Ground, Pin 2 = IN1, Pin 3 = IN2, Pin 4 = +5 V; refer also to chapter 4.5 <i>AF connection</i>

ZAS 800 antenna splitter

Inputs	2 x 50 Ω (TNC)
Outputs	8 x 50 Ω (TNC)
Frequency range	depending on the version
Amplification	0 dB \pm 3 dB
Decoupling attenuation	> 15 dB
Power supply	12 V - 15 V DC, 1A current min.
Mains	110 - 240 V AC
Current consumption	approx. 170 mA
Dimensions (L x W x H)	482 x 190 x 44 mm
Weight	approx. 1547 g

EC-DECLARATION OF CONFORMITY

**Application of
Council Directive:**

99/5/EEC
R&TTE Directive

89/336/EEC, 93/68/EEC
Electromagnetic Compatibility

2006/95/EC
Low Voltage Directive

**Standards to which
Conformity is declared:**

EN 301 489-1/-9: 2000
EN 300 422-1/-2: 2000
EN 60 065 (Safety)

Manufacturer's Name:

beyerdynamic GmbH & Co. KG

Manufacturer's Address:

Theresienstrasse 8, 74072 Heilbronn, Germany

Type of Equipment:

Receiver for Wireless Microphone System
"Opus 600"

Model Number/s:

NE 600 S, NE 600 D

I, the undersigned, as an employee of beyerdynamic, hereby declare that the equipment specified conforms to the above Directive and Standards.

Manufacturer's Signature:



Date:



January 21, 2009

Full Name:

Ulrich Roth

Position:

Director of R&D

 0682 

EC-DECLARATION OF CONFORMITY

**Application of
Council Directive:**

99/5/EEC
R&TTE Directive

89/336/EEC, 93/68/EEC
Electromagnetic Compatibility

2006/95/EC
Low Voltage Directive

**Standards to which
Conformity is declared:**

EN 301 489-1/-9: 2000
EN 300 422-1/-2: 2000
EN 60 065 (Safety)

Manufacturer's Name:

beyerdynamic GmbH & Co. KG

Manufacturer's Address:

Theresienstrasse 8, 74072 Heilbronn, Germany

Type of Equipment:

Receiver for Wireless Microphone System
"Opus 600"

Model Number/s:

S 600, SDM 660, SDM 669, SEM 681, TS 600

I, the undersigned, as an employee of beyerdynamic, hereby declare that the equipment specified conforms to the above Directive and Standards.

Manufacturer's Signature:



Date:



February 21, 2009

Full Name:

Ulrich Roth

Position:

Director of R&D

 0682 

beyerdynamic))))

beyerdynamic GmbH & Co. KG
Theresienstr. 8 | 74072 Heilbronn – Germany
Tel. +49 (0) 7131 / 617 - 0 | Fax +49 (0) 7131 / 617 - 224
info@beyerdynamic.de | www.beyerdynamic.de

Weitere Vertriebspartner weltweit finden Sie unter www.beyerdynamic.de
For further distributors worldwide, please go to www.beyerdynamic.com

