

HAMMOND

Model: *Skx*
STAGE KEYBOARD

Thank you, and congratulations on your choice of the Hammond SKX Stage Keyboard.

The Hammond SKX features authentic Hammond Organ Sound along with high-quality keyboard and orchestral voices to make it the perfect instrument for all musical occasions.

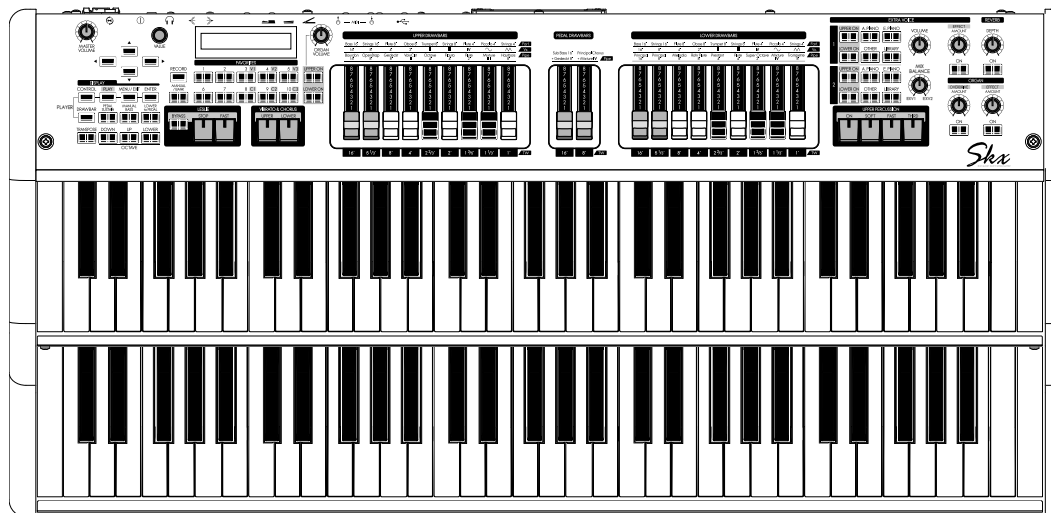

Please take the time to read this Manual completely in order to full advantage of the many features of your SKX, and please retain it for future reference.



Owner's Manual

IMPORTANT SAFETY INSTRUCTIONS

- ◆ Before using this unit, please read the following Safety instructions, and adhere to them.
- ◆ Keep this manual close by for easy reference.
- ◆ In this manual, the degrees of danger are classified and explained as follows:

	WARNING	This sign shows there is a risk of death or severe injury if this unit is not properly used as instructed.
	CAUTION	This sign shows there is a risk of injury or material damage if this unit is not properly used as instructed.

*Material damage here means a damage to the room, furniture or animals or pets.

WARNING



- ◆ Do not open (or modify in any way) the unit or its AC adaptor.



- ◆ Do not attempt to repair the unit, or replace parts in it. Refer all servicing to your retailer, the nearest Hammond Dealer, or an authorized Hammond distributor, as listed on the "Service" page.



- ◆ Never use or store the unit in places that are:
 - ◆ Subject to temperature extremes (e.g., direct sunlight in an enclosed vehicle, near a heating duct, on top of heat generating equipment)
 - ◆ Damp (e.g., baths, washrooms, on wet floors)
 - ◆ Humid
 - ◆ Exposed to rain
 - ◆ Dusty
 - ◆ Subject to high levels of vibration.



- ◆ Be sure to use only the AC adaptor supplied with the unit. And, make sure the line voltage at the installation matches the input voltage specified on the AC adaptor's case. Other AC adaptors may use a different polarity, or be designed for a different voltage, their use could result in damage, malfunction, or electric shock.



- ◆ Do not excessively twist or bend the power cord, or place heavy objects on it. Doing so can damage the cord, producing severed elements and short circuits. Damaged cords are fire and shock hazards!



- ◆ This unit, either alone or in combination with an amplifier and headphones or speakers, may be capable of producing sound levels that could cause permanent hearing loss. Do not operate for extended periods of time at a high volume level, or at a level that is uncomfortable. If you experience any hearing loss or ringing in the ears, you should immediately stop using the unit, and consult a physician.



- ◆ Do not allow any objects (e.g., flammable material, coins, pins); or liquids of any kind (water, soft drinks, etc.) to penetrate the unit.



- ◆ Immediately turn the power off, remove the AC adaptor from the outlet, and request servicing by your retailer, the nearest Hammond Dealer, or an authorized Hammond distributor, as listed on the "Service" page when:



- ◆ The AC adaptor, the power-supply cord, or the plug has been damaged; or
- ◆ If smoke or unusual odor occurs
- ◆ Objects have fallen into, or liquid has been spilled onto the unit; or
- ◆ The unit has been exposed to rain (or otherwise has become wet); or
- ◆ The unit does not appear to operate normally or exhibits a marked change in performance.



- ◆ In households with small children, an adult should provide supervision until the child is capable of following all the rules essential for the safe operation of the unit.



- ◆ Protect the unit from strong impact. (Do not drop it!)



- ◆ Do not force the unit's power-supply cord to share an outlet with an unreasonable number of other devices. Be especially careful when using extension cords - the total power used by all devices you have connected to the extension cord's outlet must never exceed the power rating (watts/amperes) for the extension cord. Excessive loads can cause the insulation on the cord to heat up and eventually melt through.



- ◆ Before using the unit in a foreign country, consult with your retailer, the nearest Hammond Dealer, or an authorized Hammond distributor, as listed on the "Service" page.



- ◆ Do not put anything that contains water (e.g., flower vases) on this unit. Also, avoid the use of insecticides, perfumes, alcohol, nail polish, spray cans, etc., near the unit. Swiftly wipe away any liquid that spills on the unit using a dry, soft cloth.



CAUTION



- ◆ The unit and the AC adaptor should be located so their location or position does not interfere with their proper ventilation.



- ◆ Always handle the AC adaptor by the plug when plugging into, or unplugging from, an outlet or this unit.



- ◆ At regular intervals, you should unplug the AC adaptor and clean it by using a dry cloth to wipe all dust and other accumulations away from its prongs. Also, disconnect the power plug from the power outlet whenever the unit is to remain unused for an extended period of time. Any accumulation of dust between the power plug and the power outlet can result in poor insulation and lead to fire.



- ◆ Try to prevent cords and cables from becoming entangled. Also, all cords and cables should be placed so they are out of the reach of children.



- ◆ Never climb on top of or place heavy objects on the unit.



- ◆ Never handle the AC adaptor or its plugs with wet hands when plugging into, or unplugging from, an outlet of this unit.



- ◆ Before moving the unit, disconnect the AC adaptor and all cords coming from external devices.



- ◆ Before cleaning the unit, turn off the power and unplug the AC adaptor from the outlet.



- ◆ Whenever you suspect the possibility of lightning in your area, disconnect the AC adaptor from the outlet.

FOR UNITED KINGDOM:

FOR YOUR SAFETY, PLEASE READ THE FOLLOWING TEXT CAREFULLY

This appliance is supplied with a molded 3-pin mains plug for your safety and convenience.

The plug contains a 13 amp fuse.

Should the fuse need to be replaced, please ensure that the replacement fuse has a rating of 13 amps and that it is approved by ASTA or BSI to BSI1362.

Check for the ASTA mark  or the BSI mark  on the body of the fuse.

If the fuse cover is lost, the plug must not be used until a replacement cover is obtained.

A replacement fuse cover can be obtained from your local Hammond Dealer.

If the fitted moulded plug is unsuitable for the socket outlet in your home, then the fuse should be removed and the plug cut off and disposed of safely.

There is a danger of severe electrical shock if the cut-off plug is inserted into any 13 amp socket.

To replace the fuse, open the fuse compartment with a screwdriver and replace the fuse and fuse cover.

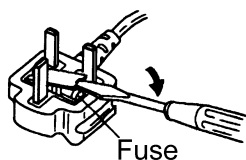

Note: This equipment has been tested and found to comply with the limits for a Class B digital device, pursuant to part 15 of the FCC Rules. These limits are designed to provide reasonable protection against harmful interference in a residential installation.

This equipment generates, uses and can radiate radio frequency energy and, if not installed and used in accordance with the instructions, may cause harmful interference to radio communications.

However, there is no guarantee that interference will not occur in a particular installation.

If this equipment does cause harmful interference to radio or television reception, which can be determined by turning the equipment off and on, the user is encouraged to try to correct the interference by one or more of the following measures:

- ◆ Reorient or relocate the receiving antenna.
- ◆ Increase the separation between the equipment and receiver.
- ◆ Connect the equipment into an outlet on a circuit different from that to which the receiver is connected.
- ◆ Consult the dealer or an experienced radio/TV technician for help.

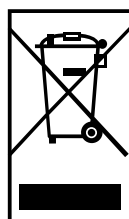

In the unlikely event that you need to dispose of this unit, be sure to contact your dealer or your nearest town or municipal office for its proper disposal.

IMPORTANT - PLEASE READ

◆ Power Supply

- ◆ Do not use this unit on the same power circuit with any device that will generate line noise (such as an electric motor or light dimming system).
- ◆ The AC adaptor will begin to generate heat after long hours of consecutive use. This is normal, and is not a cause for concern.
- ◆ Before connecting this unit to other devices, turn off the power to all units. This will help prevent malfunctions and/or damage to speakers or other devices.

◆ Placement

- ◆ Using the unit near power amplifiers (or other equipment containing large power transformers) may induce hum. To alleviate the problem, change the orientation of this unit, or move it farther away from the source of interference.
- ◆ This device may interfere with radio and television reception. Do not use this device in the vicinity of such receivers.
- ◆ Noise may be produced if wireless communications devices, such as cell phones, are operated in the vicinity of this unit. Such noise could occur when receiving or initiating a call, or while conversing. Should you experience such problems, you should relocate such wireless devices so they are at a greater distance from this unit, or switch them off.
- ◆ Do not expose the unit to direct sunlight, place it near devices that radiate heat, leave it inside an enclosed vehicle, or otherwise subject it to temperature extremes. Also, do not allow lighting devices that normally are used while their light source is very close to the unit (such as a piano light), or powerful spotlights to shine upon the same area of the unit for extended periods of time. Excessive heat can deform or discolor the unit.
- ◆ When moved from one location to another where the temperature and/or humidity is very different, water droplets (condensation) may form inside the unit. Damage or malfunction may result if you attempt to use the unit in this condition. Therefore, before using the unit, you must allow it to stand for several hours, until the condensation has completely evaporated.
- ◆ Do not allow rubber, vinyl, or similar materials to remain on the unit for long periods of time. Such objects can discolor or otherwise harmfully affect the finish.
- ◆ Do not paste stickers, decals, or the like on the SKX. Peeling such matter off the SKX may damage the exterior finish.

◆ Maintenance

- ◆ To clean the unit, use a dry, soft cloth; or one that is slightly dampened.
- ◆ To remove stubborn dirt off plastic parts, use a cloth impregnated with a mild, non-abrasive detergent. Afterwards, be sure to wipe the unit thoroughly with a soft, dry cloth. Try to wipe the entire surface using an equal amount of strength, moving the cloth along with the grain of the wood. Rubbing too hard in the same area can damage the finish.
- ◆ Never use benzine, thinners, alcohol or solvents of any kind, to avoid the possibility of discoloration and/or deformation.

◆ Additional Precautions

- ◆ Please be aware that the contents of memory can be irretrievably lost as a result of a malfunction, or the improper operation of the unit. To protect yourself against the risk of losing important data, we recommend that you periodically save a backup copy of important data you have stored in the unit's memory in another MIDI device (to another storage medium (such as a USB Flash Drive or an external hard drive).
- ◆ Unfortunately, it may be impossible to restore the contents of data once it has been lost. Hammond assumes no liability concerning such loss of data.
- ◆ Use a reasonable amount of care when using the unit's buttons, sliders, or other controls, and when using its jacks and connectors. Rough handling can lead to malfunctions.
- ◆ When connecting / disconnecting all cables, grasp the connector itself - never pull on the cable. This will avoid causing short circuits, or damage to the cable's internal elements.
- ◆ To avoid disturbing your neighbors, try to keep the unit's volume at reasonable levels. You may prefer to use headphones, so you do not need to be concerned about those around you (especially when it is late at night).
- ◆ When you need to transport the unit, package it in the box (including padding) that it came in, if possible. Otherwise, you will need to use equivalent packaging materials.

◆ Disclaimer

All trademarks and brand names mentioned in this manual are the property of their respective owners and not in any way affiliated or associated with Hammond Suzuki. The trademarks are only mentioned for explanation purposes.

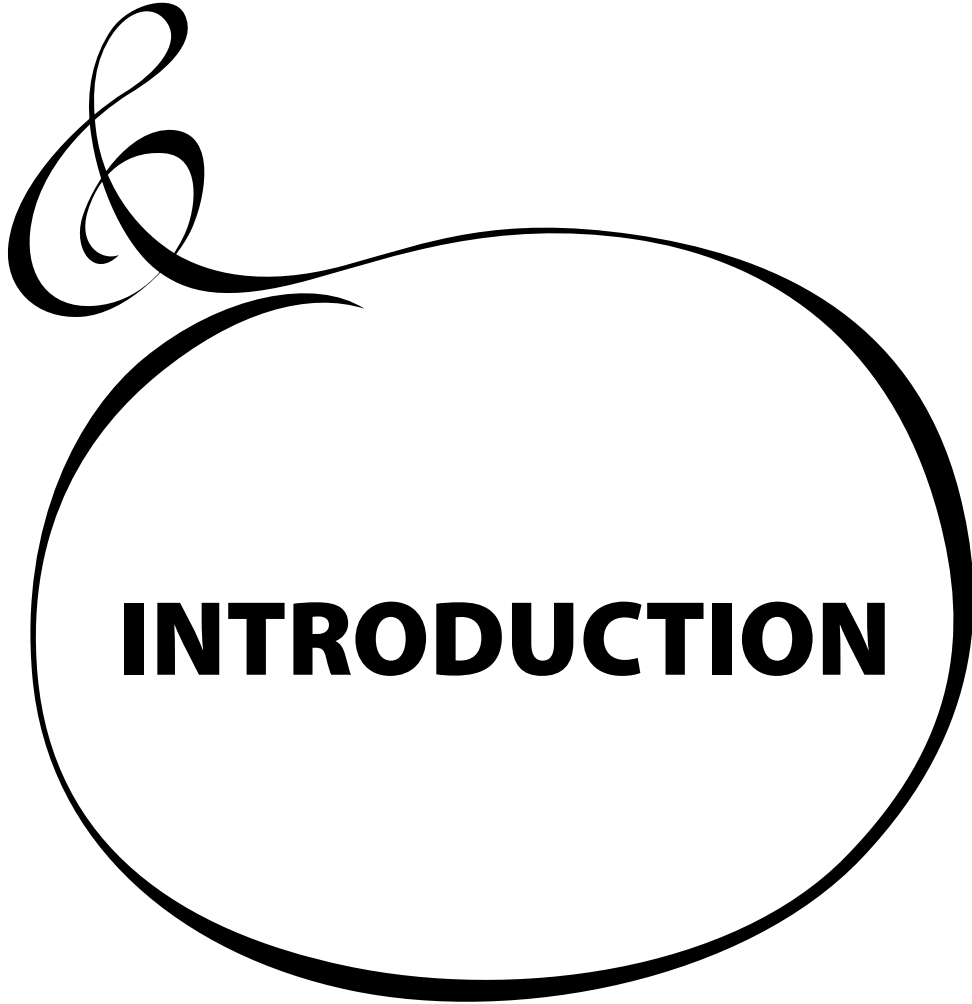
A decorative graphic featuring a treble clef on the left, with a thick black line extending from its base to form a large, rounded circle. The word "INTRODUCTION" is centered within this circle in a bold, black, sans-serif font.

INTRODUCTION

Table Of Contents

IMPORTANT SAFETY INSTRUCTIONS.....	2
IMPORTANT - PLEASE READ.....	4

INTRODUCTION 5

MAIN FEATURES	9
NAMES AND FUNCTIONS	10
TOP PANEL.....	10
REAR PANEL	13
KEYBOARD.....	14
ACCESSORIES.....	14

HOOK-UP 15

BASIC HOOK-UP	16
CONNECTING THE LESLIE SPEAKER	17
BASIC CONNECTION	17
USING 3 CHANNEL TYPE (SUCH AS 2101/mk2)	17
USING SINGLE CHANNEL TYPE (SUCH AS 122XB, 3300/W).....	17
MIDI CONTROL OF THE LESLIE SPEAKER	17
EXPAND THE KEYBOARD.....	18
PEDALBOARD (13 OR 20 KEYS)	18
PEDALBOARD (25 KEYS)	19

GETTING READY TO PLAY 21

SWITCH ON	22
HOW TO POWER ON	22
BACK UP	22
AUTO POWER OFF	22
RESET TO THE FACTORY SETTINGS	22
PLAY WITH THE PATCHES	23
"USER" AND "PRESET"	23
HOW TO CALL A PATCH.....	23
Example: Select U041.....	23
REGISTER FAVORITE PATCHES (FAVORITES)	24
Register PATCHES to FAVORITES	24
Ex. Register U041 to "3-2".....	24
How to recall FAVORITES.....	24
Ex. Call the "3-2".....	24
BANK and NUMBER	24
Column: RECORD FAVORITES LIKE PRESET BUTTONS.....	25
USE THE FOOT CONTROLLERS	26
EXPRESSION PEDAL	26
FOOT SWITCH.....	26
DAMPER PEDAL	26
TRY CREATING YOUR OWN SOUND.....	27
SELECT [MANUAL]	27
Column: INITIALIZE THE INTERNAL SETTINGS [MANUAL].....	27
SWITCH THE ORGAN SECTION ON.....	28
PULL OUT DRAWBARS.....	28
ADD THE TOUCH-RESPONSE PERCUSSION.....	28
ADD EFFECTS TO THE ORGAN SECTION	29
VIBRATO & CHORUS.....	29
LESLIE.....	29
OVERDRIVE	29

MULTI-EFFECTS	29
ALLOCATING THE EXTRA VOICES.....	30
SELECT AN INSTRUMENT	30
ADJUST THE VOLUME BALANCE.....	30
Column: To select the other group (e.g."Wind").....	30
ADD EFFECTS TO THE EXTRA VOICE SECTION	31
MULTI-EFFECTS	31
ADD REVERB TO BOTH SECTIONS	31
REVERB	31
WHAT IS A "PART" ?.....	32
MANUAL BASS	32
LOWER TO PEDAL.....	33
PEDAL SUSTAIN	33
RECORD THE PATCH TO MEMORY	34
Example: RECORD TO U032	34

SETTING UP 35

SOUND ENGINE STRUCTURE	36
ORGAN SECTION	37
EXTRA VOICE SECTION.....	37
MASTER EQUALIZER.....	37
ORGAN SECTION.....	38
ORGAN TYPE.....	38
TONE-WHEELS (BType1, BType2, Mellow)	38
TRANSISTOR (Vx, Farf)	38
PIPE.....	38
Column: SELECTING THE ORGAN TYPES.....	39
Example: Switching the Organ Type to "Pipe".....	39
HARMONIC DRAWBARS™	40
DRAWBARS (ON TONE-WHEEL: BType1, BType2, Mellow).....	40
DRAWBARS FOR THE UPPER AND LOWER PARTS	41
DRAWBARS TO USE ON THE PEDAL	41
DRAWBAR REGISTRATION PATTERNS.....	42
MODERN DRAWBAR REGISTRATIONS.....	43
DRAWBARS (Vx).....	44
DRAWBARS (Farf).....	45
DRAWBARS (PIPE)	46
OPERATING ORGAN SECTION	47
ON / OFF AND VOLUME CONTROL.....	47
MATCH THE REGISTRATION TO DRAWBARS.....	47
PERCUSSION.....	48
1' DRAWBAR CANCEL	48
VIBRATO & CHORUS	49
TO SELECT THE VIBRATO & CHORUS MODE.....	49
OVERDRIVE.....	50
LESLIE.....	51
MULTI-EFFECTS, REVERB	52
PEDAL SUSTAIN, COUPLER	53
OCTAVE SHIFT	54
TRANPOSE	55
EXTRA VOICE SECTION	56
ALLOCATE	56
BUILT IN SOUNDS AND LIBRARY	56
MULTI-EFFECTS, REVERB	57
PATCH.....	58
"USER" AND "PRESET"	58
NAME THE PATCH.....	59

RECORD TO THE PATCH.....60	MULTI-EFFECTS.....97
Example: RECORD TO "U032".....60	EQUALIZ (Equalizer).....98
USING THE CONTROL PANEL..61	◆ ORGAN SECTION.....98
WHAT YOU CAN DO ON THE CONTROL PANEL.....62	◆ ORGAN SECTION, EXTRA VOICE SECTION, MASTER.....98
PLAY MODE.....63	REVERB.....99
HOW TO READ THE DISPLAY.....63	TUNE.....100
BUTTON OPERATION IN THIS MODE.....63	◆ MASTER TUNE.....100
MENU MODE.....64	DEFAULT.....101
HOW TO READ THE DISPLAY.....64	SYSTEM.....102
BUTTON OPERATION IN THIS MODE.....64	MIDI103
MENU AND THE CONTENTS.....65	ABOUT MIDI.....104
FUNCTION MODE.....66	WHAT IS "MIDI"?.....104
HOW TO READ THE DISPLAY.....66	MIDI JACKS ON THE SKX.....104
BUTTON OPERATION IN THIS MODE.....66	WHAT THE MIDI CAN DO ON THE SKX.....104
PARAMETER OPERATION EXAMPLE.....67	WHAT IS A "MIDI TEMPLATE?".....104
SHORT CUT TO FUNCTION MODE.....69	MIDI CHANNEL.....105
EXAMPLE OF OPERATION.....69	MAIN MIDI MESSAGE.....105
REGISTER THE PAGES YOU FREQUENTLY USE.....69	CHANNEL MESSAGE.....105
EXAMPLE OF OPERATION.....69	SYSTEM MESSAGE.....105
LOCKING THE DISPLAY.....70	MIDI STRUCTURE.....106
SETTING THE PARAMETERS ...71	◆ KEYBOARD CHANNELS.....107
DRAWBAR.....72	◆ EXTERNAL ZONE CHANNELS.....107
◆ SETTING FOR MANUAL (LOWER & UPPER) DRAWBARS.....72	◆ EXPANDED KEYBOARDS.....107
◆ SETTING THE PEDAL PART.....73	USING AN EXTERNAL SEQUENCER.....108
PATCH.....74	◆ Recording a performance to an external sequencer.....108
◆ PATCH NAME.....74	◆ Sequencer playback.....108
◆ PATCH LOAD.....74	USING A MIDI SOUND MODULE.....109
◆ FAVORITES.....74	ZONES.....110
EXVOICE (Extra Voices).....75	◆ WHAT IS DISPLAYED ON THE UPPER LEFT?.....110
CONTROL.....76	◆ INTERNAL ZONE.....110
◆ FOOT SWITCH.....76	◆ EXTERNAL ZONE.....110
◆ EXPRESSION.....77	PANIC FUNCTION AND PARAMETER RE-LOAD.....111
◆ GLIDE.....78	MIDI.....112
◆ DAMPER.....78	◆ MIDI TEMPLATE.....112
◆ ASSIGN.....78	◆ MASTER.....112
◆ DISPLAY.....79	◆ KEYBOARD CHANNELS.....113
◆ KEYBOARD.....79	SAVE THE SETUP115
◆ PART.....79	SAVE YOUR SETUP.....116
PERCUSS (Percussion).....80	WHAT YOU CAN DO WITH THE USB FLASH DRIVE.....116
VIB&CHO (Vibrato & Chorus).....81	ABOUT USB FLASH DRIVE.....116
LESLIE.....82	USABLE USB FLASH DRIVE.....116
◆ CABINET NUMBER.....82	USB FLASH DRIVE CONNECTOR.....116
◆ LESLIE PARAMETERS.....82	FOLDER STRUCTURE.....116
◆ EXTERNAL LESLIE SPEAKER.....84	INITIALIZE THE USB FLASH DRIVE.....117
RECORD THE CABINET.....84	WORKING WITH SETUPS.....118
CUST. TW (Custom Tone Wheels).....85	HOW TO READ THE DISPLAY.....118
Record the CUSTOM virtual Tone Wheels.....87	SAVING THE SETUP.....118
PIPE.....88	CHANGING THE SETUP NAME.....119
OD / EFF (Overdrive / Effects).....90	LOADING THE SETUP.....120
◆ ORGAN SECTION EFFECTS.....90	DELETING THE SETUP.....120
OVERDRIVE.....90	WORKING WITH PATCHES.....121
MULTI-EFFECTS.....91	HOW TO READ THE DISPLAY.....121
◆ EFFECTS FOR THE EXTRA VOICE SECTION.....97	SAVING THE PATCH.....121
OVERDRIVE.....97	LOADING A PATCH.....122
	DELETING THE PATCH.....122

WORKING WITH CUSTOM TONE WHEEL.....	123
HOW TO READ THE DISPLAY	123
SAVE THE CUSTOM TONE WHEEL FILE.....	123
LOADING A CUSTOM TONE WHEEL	124
DELETING A CUSTOM TONE WHEEL.....	124

MUSIC PLAYER 125

BEFORE PLAYING BACK	126
FILE TYPE AND PLACING FOLDER	126
HOW TO READ THE DISPLAY	126
WORKING WITH THE MUSIC PLAYER.....	127
MUSIC PLAYER MODES	128

VOICE LIBRARY 129

WHAT IS VOICE LIBRARY?.....	130
FILE TYPE AND THE PLACING FOLDER.....	130
VOICE LIBRARY AND SETUPS	130
WORKING WITH VOICE LIBRARY	131
LOADING THE VOICE LIBRARY	131
DELETE A VOICE LIBRARY	132
CLEAR ALL VOICE LIBRARIES	132

Troubleshooting 133

TROUBLESHOOTING.....	134
----------------------	-----

APPENDIX..... 135

EXTRA VOICE INSTRUMENT LIST	136
PRESET PATCH LIST.....	138
MIDI TEMPLATES	139
MIDI TEMPLATES	139
MIDI INFORMATION	140
MIDI Implementation.....	140
Channel Voice Message	140
Channel Mode Message	140
Drawbar Data List 1	141
Control Number.....	141
Drawbar Data List 2.....	141
System Exclusive Message.....	142
Mode Setting Exclusive Message	142
NRPN Switch	142
Data Set (Rx. only).....	142
Identity Request (Rx. only)	142
Identity Reply (Tx. only)	142
Global Parameters	143
Patch Parameters	144
Leslie Parameters	148
System Parameters.....	148
Tone Wheel Parameters.....	148
Pipe Parameters.....	148
CUSTOM TONE-WHEELS LIST	149
MIDI IMPLEMENTATION CHART	150
MIDI CHANNELS AND MESSAGES.....	151
SPECIFICATIONS	152
SERVICE	155

◆ AUTHENTIC HAMMOND DRAWBAR ORGAN

The SKX is first and foremost a genuine Hammond Organ with “Virtual Tone Wheels” to provide the classic Hammond sound. Also available are the tones of vintage “combo” organs, and a variety of pipe organ ranks to provide church and classical organ voices.

◆ EXTRA VOICE SECTION

The EXTRA VOICE section provides high quality Acoustic and Electric Pianos, as well as other Keyboard and Orchestral voices. Additional Voice Libraries can be downloaded and installed using a USB Flash Drive.

The Organ and Extra Voice can be used together, and their outputs can be individually accessed, using the Leslie Speaker for the Organ section, and the LINE OUT jack(s) for the Extra Voice section.

◆ DIGITAL LESLIE/VIBRATO

A digital and programmable Leslie is available for the Drawbar voices, as well as the traditional “Vibrato/Chorus” as used on the legendary B-3/C-3. The Vibrato/Chorus may be selected for the Upper and Lower parts, independently.

◆ A WIDE VARIETY OF EFFECTS

Digital Multi-effects are available for the Organ and Extra Voice sections independently. A Master Equalizer allows you to tailor the total tonal response of the SKX.

◆ MUSIC PLAYER

The SKX is equipped to play MP3/WAV type audio files. This makes it very convenient for accompanying solo performances or practicing.

◆ MIDI MASTER KEYBOARD

External Zones are available to enable the SKX to be used as a master keyboard.

◆ PATCHES AND FAVORITES

In addition to the 100 available user-defined Patches, 10×10 “Favorite” quick-call Patches are available for on-stage ease.

◆ BUILT-IN USB PORT

This allows you to use a USB Flash Drive to save Patches, Setups, etc. as well as to use the built-in Music Player, install additional Voice Libraries and update the system software of the instrument.

◆ LESLIE SOCKET

An 11-pin Leslie receptacle is provided which allows you to use the SKX with a Leslie Speaker having an 11-pin interface.

◆ SMALL AND LIGHT WEIGHT

The SKX is small and light weight, making transport and setup easy.

TOP PANEL

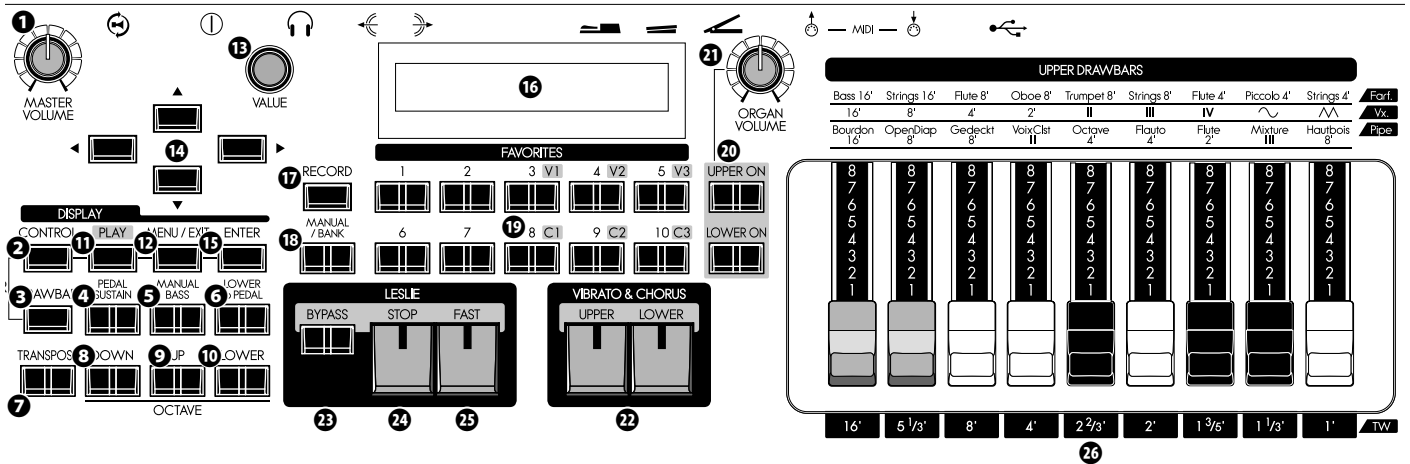

◆ UPPER LEFT

❶ MASTER VOLUME knob

Allows you to control the volume of the entire instrument. (P. 22)

❷ CONTROL button

Allows you to access a feature from the CONTROL Function mode. (P. 76)

❸ DRAWBAR button

Allows you to access the DRAWBAR Function mode to set the Organ Type etc. (P. 39)

◆ KEYBOARD CONTROL

❹ PEDAL SUSTAIN button

Allows you to add a smooth decay to the PEDAL tones similar to a string bass. (P. 33)

❺ MANUAL BASS button

Allows you to play the PEDAL tones from the LOWER keyboard. (P. 32)

❻ LOWER to PEDAL button

Allows you to play the tones from the LOWER part from a connected MIDI Pedalboard. (P. 33)

❼ TRANSPOSE button

Allows you to shift the musical key of the entire instrument. (P. 55)

❽ OCTAVE DOWN button

❾ OCTAVE UP button

These two buttons allow you to move the pitch of the UPPER part “UP” or “DOWN” by one octave. (P. 54)

❿ OCTAVE LOWER button

Allows you to move the pitch of the LOWER part “UP” or “DOWN” by octaves when used in conjunction with the OCTAVE DOWN/UP buttons. (P. 54)

◆ CONTROL PANEL

⓫ PLAY button

Allows you to return to the Play, or basic mode. (P. 63)

⓬ MENU/EXIT button

Allows you to access Menu mode in the display and return to the Menu mode from other Function modes. (P. 64)

⓭ VALUE knob

Allows you to increase/decrease Patch numbers while performing or adjusts values during editing.

⓮ DIRECTION buttons

Allows you to move the cursor in the display or locate other pages.

⓯ ENTER button

Allows you to confirm the current entry or procedure when editing sounds or features.

⓰ DISPLAY

◆ FAVORITES

⓱ RECORD button

Allows you to record user-definable features such as Patches, Favorites, etc. (P. 34)

⓲ MANUAL/BANK button

Allows you to override the current Patch setting in favor of the current Panel settings. (P. 27)

Also, allows you to select Favorite Banks by pressing this button with one of the numbered FAVORITE buttons. (P. 24)

⓳ NUMBER buttons

Allows you to recall Patches you frequently use quickly. (P. 24)

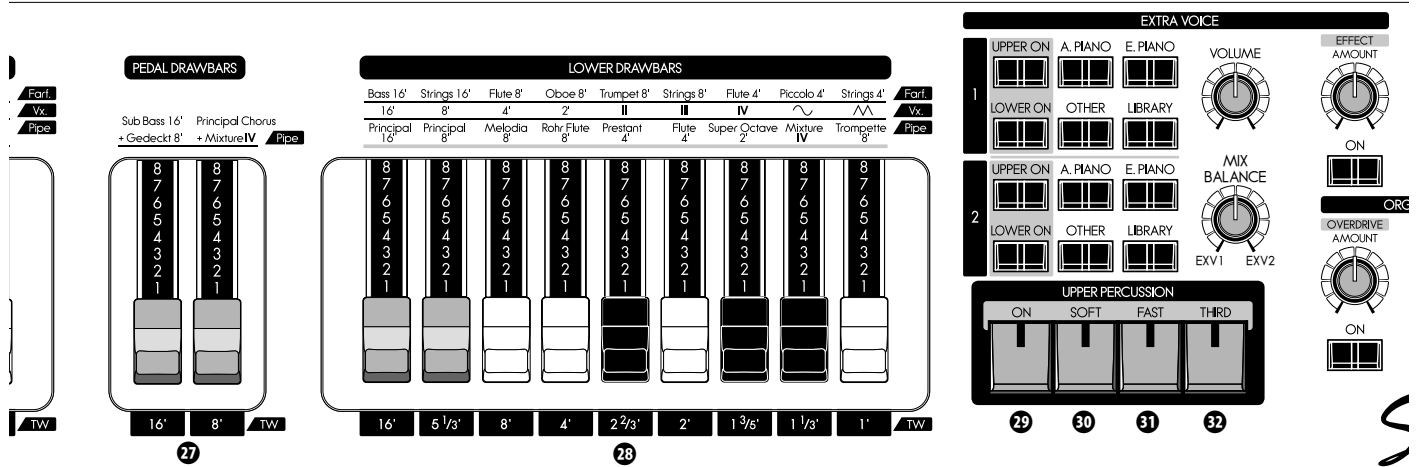

◆ ORGAN SECTION

20 UPPER ON, LOWER ON buttons

Allows you to “sound” or “mute” each part of the Organ section.

21 ORGAN VOLUME knob

Allows you to controls the volume of the entire Organ section. (P. 47)

◆ VIBRATO & CHORUS

22 UPPER, LOWER buttons

Allows you to select which part receives the Vibrato & Chorus Effect. (P. 49)

◆ LESLIE

23 BYPASS button

Allows you to direct the sounds produced by the Organ section from the Rotary channel to the Stationary channel. (P. 51)

24 STOP button

Allows you to stop the Leslie Rotors from turning when the [FAST] button is “OFF”. (P. 51)

25 FAST button

Toggles the modes of the Rotors FAST or not. When the light is ON, it is FAST. (P. 51)

◆ DRAWBARS

These are for adjusting the basic harmonics of the Organ section. The function of each drawbar is different depending on the type of Organ (Tone Wheel/Transistor/Pipe). (P. 40)

26 UPPER Drawbars

Allows you to adjust the UPPER part.

27 PEDAL Drawbars

Allows you to adjust the PEDAL part.

28 LOWER Drawbars

Allows you to adjust the LOWER part.

◆ PERCUSSION

29 ON button

Allows you to add the Percussion effect to the UPPER part. (P. 48)

30 SOFT button

Allows you to select “NORMAL” or “SOFT” Percussion volume. (P. 48)

31 FAST button

Allows you to select “SLOW” or “FAST” Percussion decay time. (P. 48)

32 THIRD button

Allows you to select “SECOND” (4’) or “THIRD” (2 2/3’) Percussion harmonic. (P. 48)

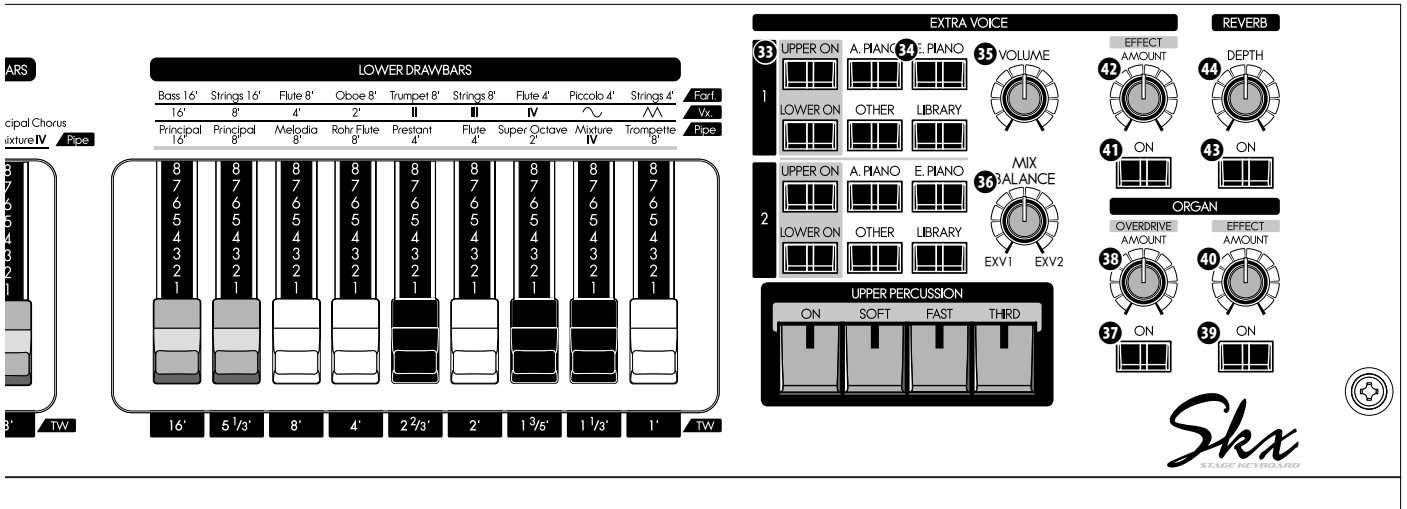

◆ EXTRA VOICES

33 ALLOCATE UPPER, LOWER button

Allows you to assign the Extra Voice sections to either the UPPER, and LOWER parts. (P. 56)

34 VOICE GROUP buttons

Allows you to select the Voice Group of the Extra Voice sections. (P. 30)

35 VOLUME knob

Allows you to adjust the entire volume of the Extra Voice sections. (P. 30)

36 BALANCE knob

Allows you to adjust the balance between Extra Voice sections 1 and 2. (P. 30)

◆ EFFECTS FOR THE ORGAN SECTION

37 DRAWBARS OVERDRIVE ON button

Allows you to turn the Organ Overdrive effect “ON” or “OFF”. (P. 50)

38 DRAWBARS OVERDRIVE AMOUNT knob

Allows you to adjust the amount of the Organ Overdrive effect. (P. 50)

39 DRAWBARS EFFECT ON button

Allows you to turn the selected Organ Multi-Effect “ON” or “OFF”. (P. 52)

40 DRAWBARS EFFECT AMOUNT knob

Allows you to adjust the amount of the Organ Multi-Effects. (P. 52)

◆ EFFECTS FOR THE EXTRA VOICE SECTION

41 EXTRA VOICE EFFECT ON button

Allows you to turn the selected Extra Voice Multi-Effect “ON” or “OFF”. (P. 57)

42 EXTRA VOICE EFFECT AMOUNT knob

Allows you to adjust the amount of the selected Extra Voice Multi-Effects. (P. 57)

◆ EFFECTS FOR ALL PARTS

43 REVERB ON button

Allows you to turn the Reverb effect “ON” or “OFF”. (P. 52)

44 REVERB DEPTH knob

Allows you to adjust the depth of the Reverb. (P. 52)

REAR PANEL

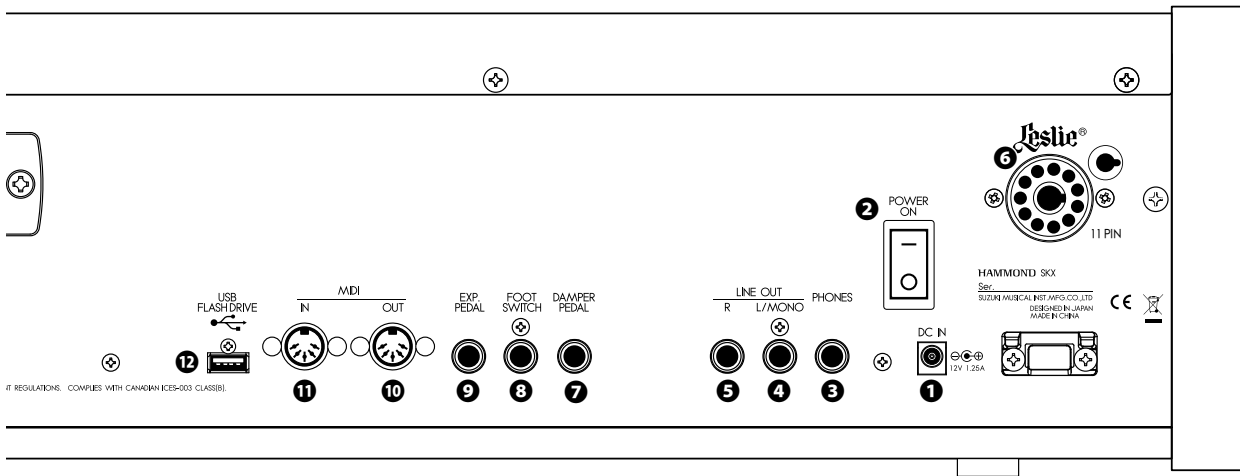

◆ POWER

① DC IN jack

Connect the AC adaptor AD3-1250-2P to this jack.
Use with strain relief to avoid accidentally disconnecting the power during performance. (P. 16)

② ① POWER switch

Turns the power to the SKX “ON” or “OFF.” (P. 22)

◆ AUDIO OUTPUT TERMINALS

③ PHONES jack

Connect a set of stereo headphones to this jack.

NOTE: Connecting Headphones does NOT mute the LINE OUT or LESLIE audio outputs.

④ LINE OUT L/MONO jack

⑤ LINE OUT R jack

Use these jacks to connect an external audio equipment.

If the connected mixer or monitor speaker is stereophonic, connect both L and R. If monaural, connect only to the L/MONO jack (P. 16) and set the Audio Mode at “MONO” (P. 102).

⑥ Leslie® LESLIE 11 PIN socket

Connect a Leslie Speaker equipped with an 11-pin interface here.

When the connection of a physical Leslie Speaker is detected, the on-board digital Leslie Simulator is disabled at the PHONES jack and the LINE OUT jacks. (P. 17)

◆ CONTROLLER TERMINALS

⑦ DAMPER PEDAL jack

Connect an optional Damper Pedal (optional VFP1 etc.) here.
If you press the connected Damper Pedal while holding down keys, the sound is sustained even after you release the key(s) similar to the damper pedal on an acoustic piano. (P. 78)

NOTE: Use ONLY a Damper Pedal equipped with a Monaural connecting plug. DO NOT use a pedal having a Stereo or “TRS-compatible” plug, as it will not function.

⑧ FOOT SWITCH jack

Connect the Foot Switch here.

Please see (P. 76) for information about the different functions available for the Foot Switch.

The following Foot Switches / Damper Pedals can be used with SKX:

HAMMOND	VFP1, FS-9H
BOSS	FS-5U
YAMAHA	FC4A, FC5

⑨ EXP. PEDAL jack

Connect an optional Expression Pedal here.

This allows you to control the volume while playing. (P. 77)

The following Expression/Volume Pedals can be used with the SKX:

HAMMOND	EXP-50J, EXP-20, V-20H, V-20R; NORM
KORG	XVP-10, XVP-20; REV
Roland	EV-5; NORM
YAMAHA	FC7; REV

◆ MIDI TERMINALS

⑩ MIDI OUT jack

MIDI data is transmitted from this jack. (P. 104)

⑪ MIDI IN jack

MIDI data is received via this jack.

NOTE: The SKX is factory-programmed to receive incoming MIDI data from a connected MIDI Pedalboard regardless of the current MIDI Channel setting. (P. 104)

◆ USB TERMINAL

⑫ USB FLASH DRIVE port

Use this port to connect a USB Flash drive. (P. 116)

KEYBOARD

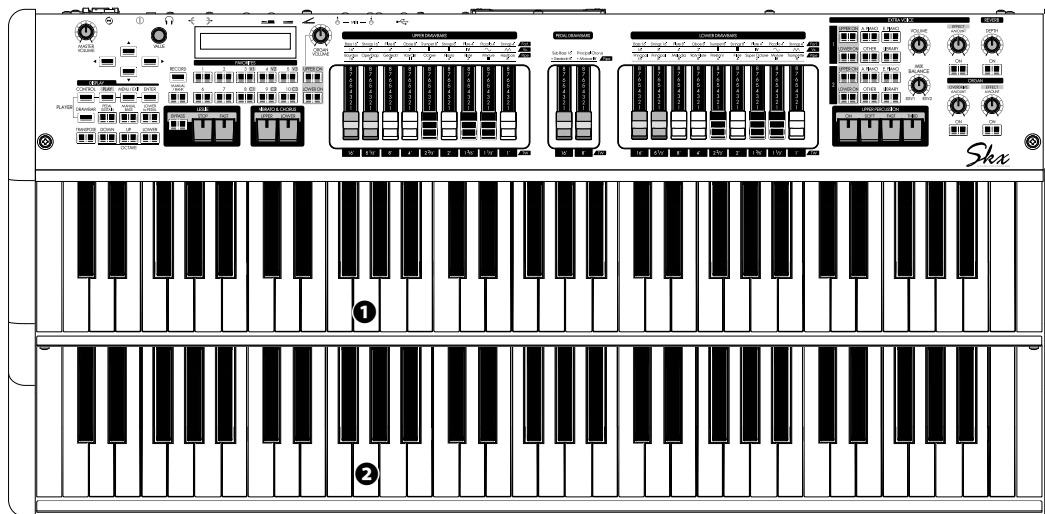

1 UPPER keyboard

61 Square-front (“waterfall”-style) keys, velocity sensitive.
This is for playing the UPPER part.

2 LOWER keyboard

61 Square-front (“waterfall”-style) keys, velocity sensitive.
This is for playing the LOWER part.

ACCESSORIES

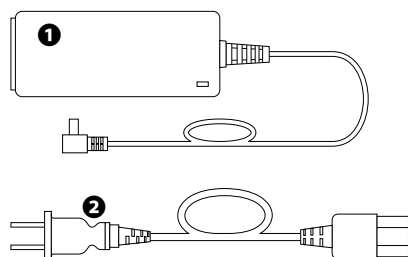

1 AC adaptor

Supplies power to the SKX.

**NOTE: Use only a Hammond-approved AC adaptor AD3-1250-2P,
DO NOT substitute another similar-looking AC adaptor.**

2 AC cord set

Plug one end into AC adaptor and the other end into an AC wall outlet.

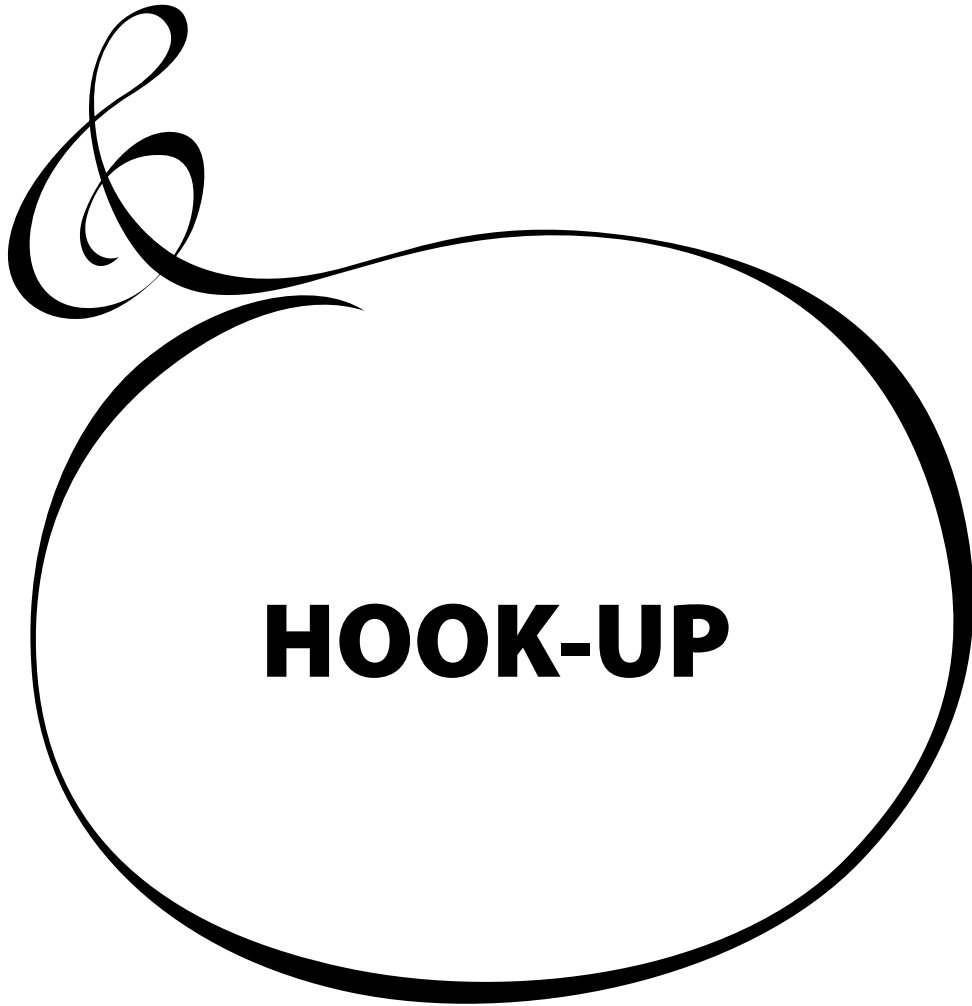

HOOK-UP

BASIC HOOK-UP

Connect audio cables and accessories as shown below.

The SKX is not self-contained - an external amplifier/speaker system is required in order to hear the sound. However, if you connect a set of stereo headphones to the PHONES jack, you can hear the sound through the headphones even if an external amplifier is not connected.

NOTE: Make sure both the instrument and amplifier are "OFF" before connecting amplifiers or headphones.

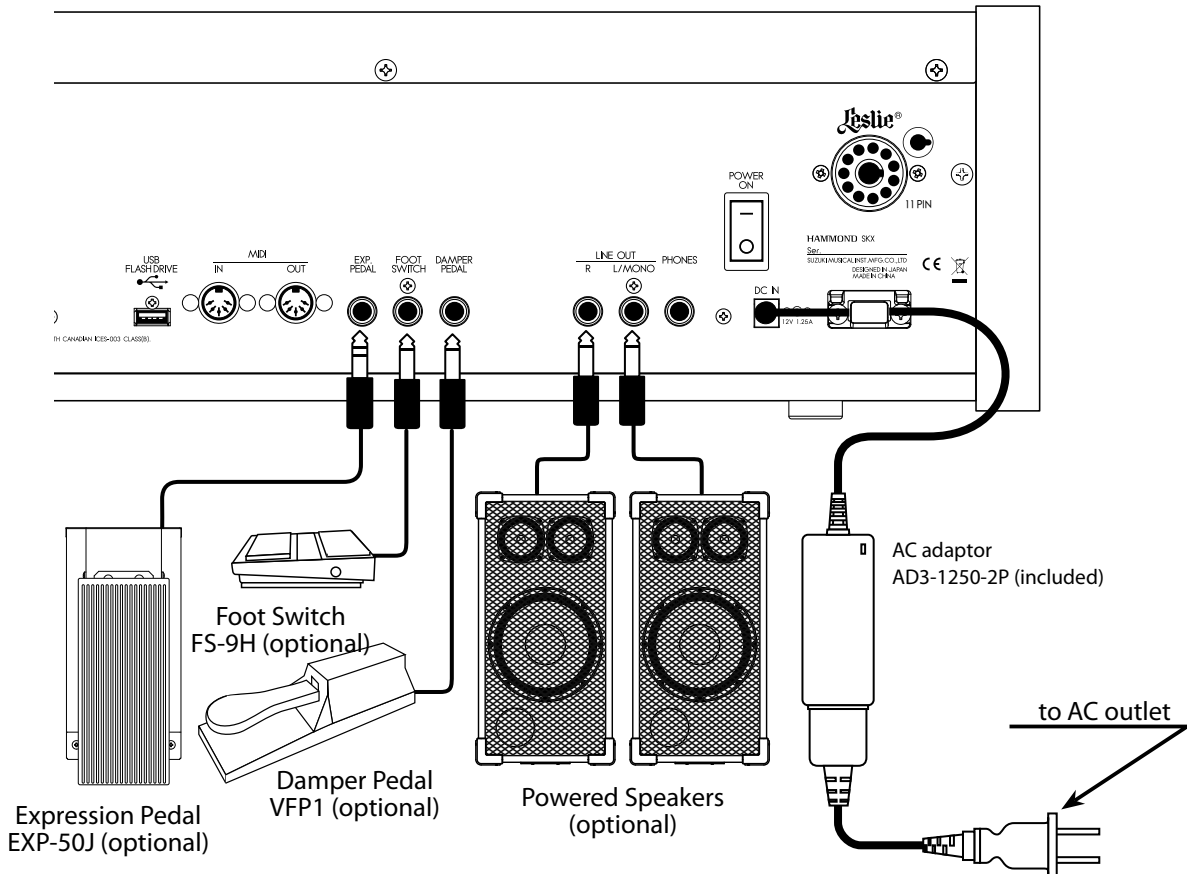

The Expression Pedal and Foot Switch parameters must be set properly. For details see [CONTROL]. (P. 76)

Set Audio Mode either stereo or mono connection. (P. 102)

⚠ CAUTION

Do not place this unit in direct sun light, near heat sources, or in a hot location.

An 11-pin type Leslie speaker can be directly connected to SKX.

NOTE: Switch OFF before connecting the Leslie speaker.

Connecting with single channel type

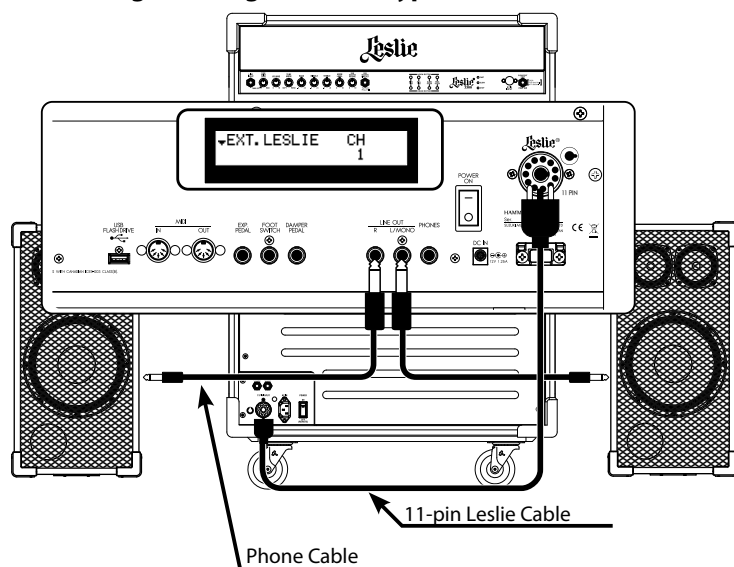

Connecting with 3 channel type

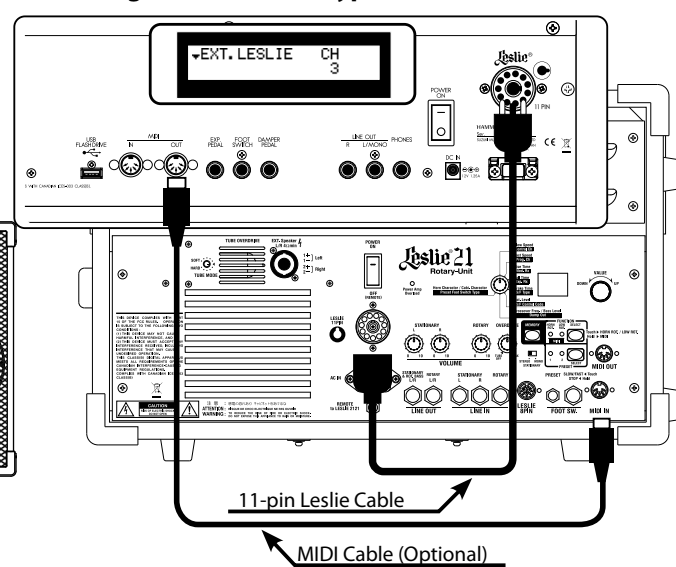

BASIC CONNECTION

USING 3 CHANNEL TYPE (SUCH AS 2101/mk2)

1. Connect the Leslie Speaker and the Leslie 11-PIN socket on the SKX with the exclusive 11-pin Leslie cable (optional LC-11-7M, not included).
2. Turn on the power, and set the EXT. LESLIE CH parameter at “3”. (P. 84)
3. Make the setting of Tone Wheel organ.
4. Switch “ON” the [BYPASS] button, set the [STATIONARY VOLUME] of the Leslie Speaker at desired volume.
5. Repeat “ON/OFF” the [BYPASS] button with playing the keyboard, set the [ROTARY VOLUME] of the Leslie Speaker at same volume which you can hear.

USING SINGLE CHANNEL TYPE (SUCH AS 122XB, 3300/W)

1. Connect the Leslie Speaker and the Leslie 11-PIN socket on the SKX with the exclusive 11-pin Leslie cable (optional LC-11-7M, not included).
2. Connect the audio equipment such as powered speakers and Line Out of the SKX with audio cable.
3. Turn on the power, and set the EXT. LESLIE CH parameter at “1”. (P. 84)
4. Make the setting of Tone Wheel organ.
5. Switch “ON” the [BYPASS] button, set the audio equipment at desired volume.
6. Repeat “ON/OFF” the [BYPASS] button with playing the keyboard, set the [VOLUME] of the Leslie Speaker at same volume which you can hear.

MIDI CONTROL OF THE LESLIE SPEAKER

To control the parameters of the Leslie Speaker 2101/mk2 (fine adjustment of the Rotor speed or the rise time, etc.):

1. Connect the MIDI OUT of the SKX with the MIDI IN of the Leslie Speaker with a MIDI cable.
2. Set the Keyboard channel - TX UPPER and the Leslie MIDI channel to the same channel. (P. 113)

When the SKX detects that the Leslie Speaker is connected, the Leslie parameters sent through MIDI from the SKX are switched from the SKX original to those for the Leslie Speaker.

tips LESLIE SPEAKERS TO BE CONNECTED

The SKX is designed to connect with 3 channel Leslie speakers such as 2101/mk2. However, it is also possible to connect 1 channel type Leslie speakers such as 122XB, 3300/W sending the stationary channels to the LINE OUT jacks independently. (P.84)

tips LESLIE CHANNEL

3 channel type Leslie speakers are equipped with a stereo speaker system, independent of the Rotor, to provide stereo sound for the Extra Voices and direct organ sounds.

A traditional single-channel Leslie speakers, such as a #122 or #147 has no stationary speaker system, thus requiring a separate amplifier/speaker for the Extra Voices or direct organ sounds.

EXPAND THE KEYBOARD

The SKX can be upgraded to dual keyboards by connecting an external MIDI Pedalboard.

PEDALBOARD (13 OR 20 KEYS)

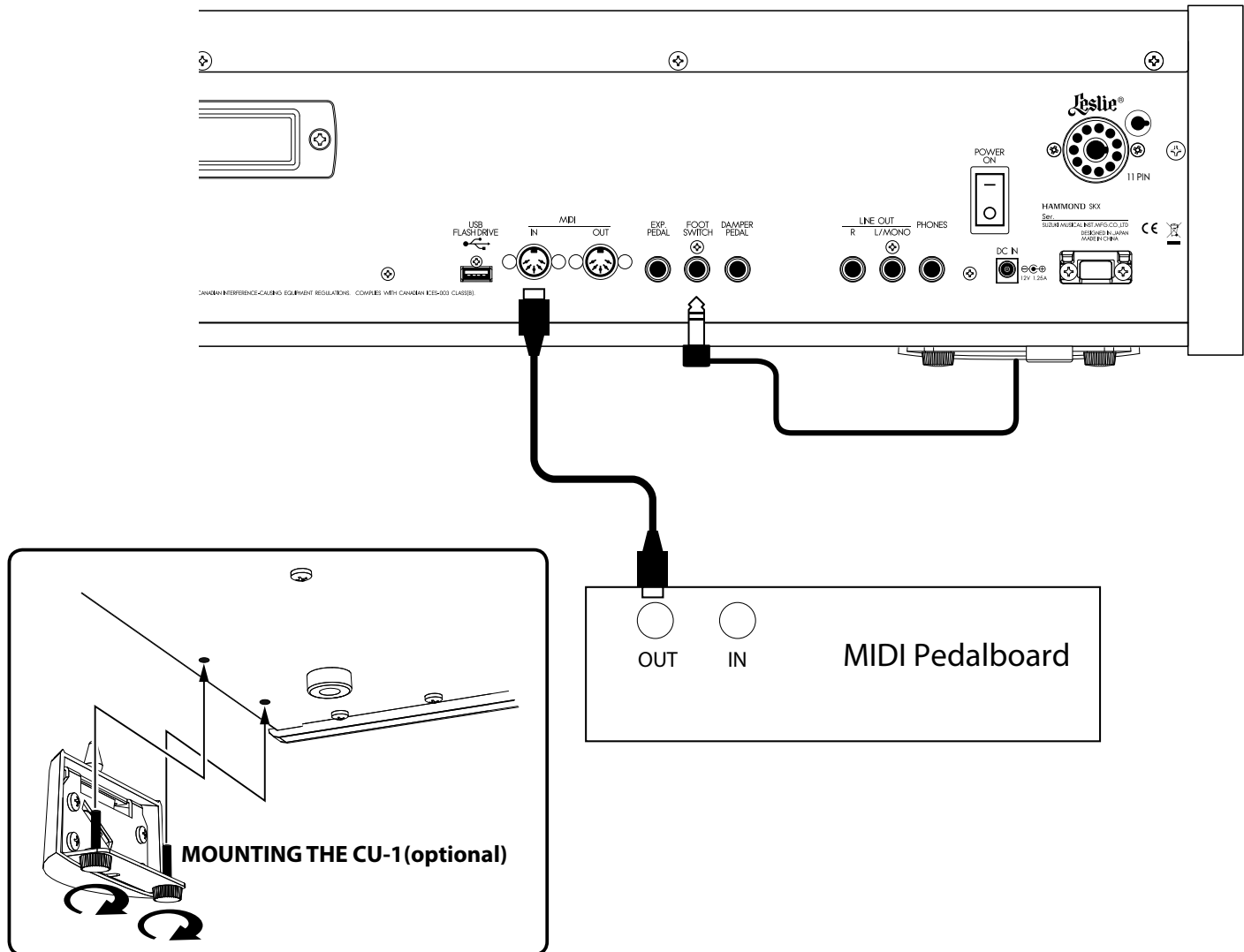

1. Connect the MIDI OUT of the MIDI pedalboard to the MIDI IN of the SKX with a MIDI cable.
 2. When using a Leslie Switch CU-1, connect the CU-1 to the FOOT SWITCH jack.
- NOTE:** This illustration shows only the Pedalboard expansion. See P.16 for the basic hook up of the power source, audio, etc.
3. Switch ON the power of the SKX and call the MIDI template “Pedal KBD”. (P. 112)
 4. When using the CU-1, set the CONTROL - FOOT DEVICE” at “CU-1”. (P. 76)

◆ RECOMMENDED MIDI PEDALBOARDS

The following MIDI pedalboards are recommended for use with SKX:

- ◆ MIDI sound pedalboard XPK-130G (13 keys)
- ◆ MIDI sound pedalboard XPK-200G (20 keys)
- ◆ MIDI sound pedalboard XPK-200GL (20 long keys)
- ◆ XPK-100, -200, -200L also can be used.

PEDALBOARD (25 KEYS)

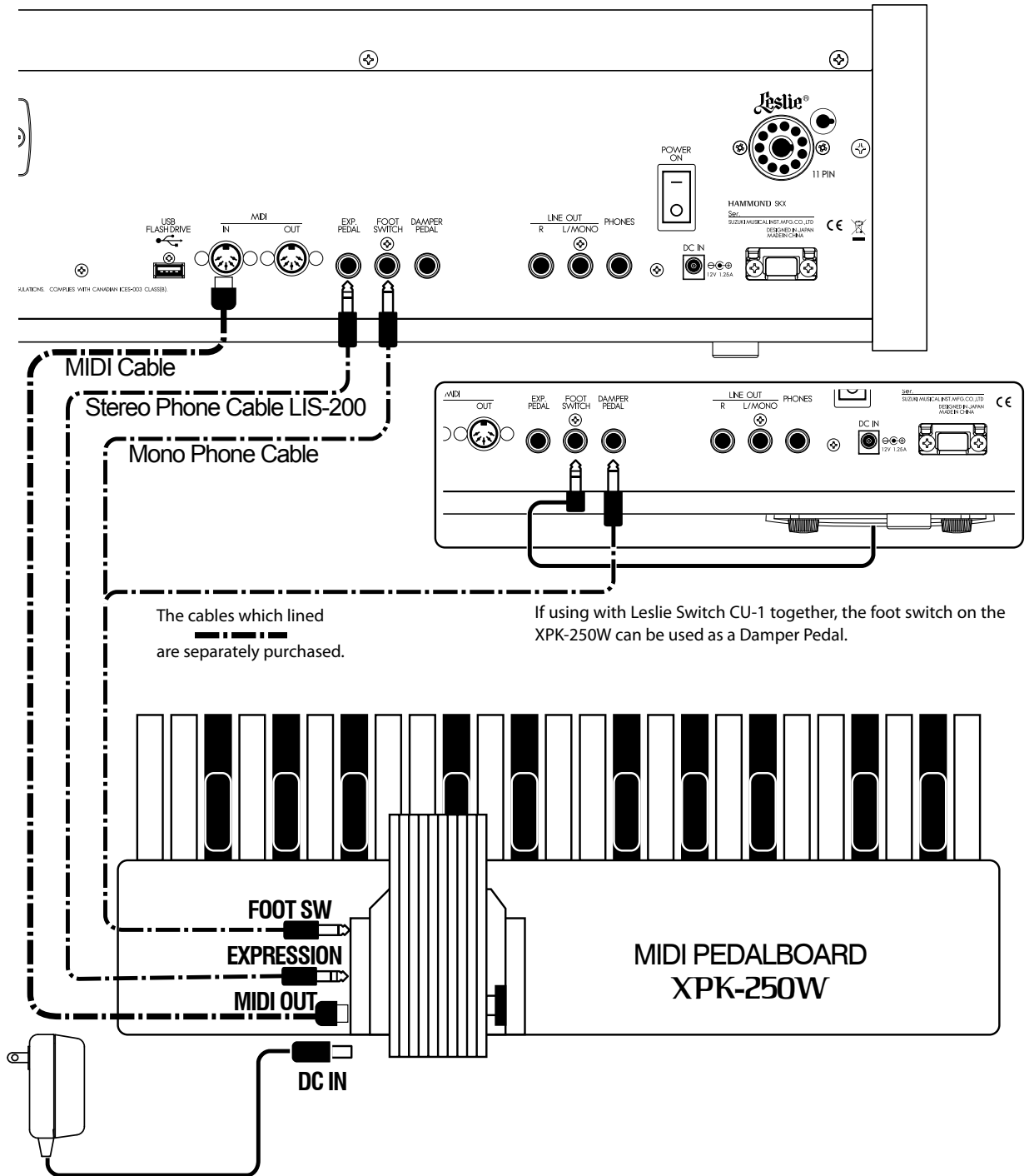

The cables which lined
are separately purchased.

If using with Leslie Switch CU-1 together, the foot switch on the
XPK-250W can be used as a Damper Pedal.

AC Adaptor:
AD1-1210 (100-120V region)
AD3-1210 (220-240V region)
Separately purchased

1. Hook up as illustrated above.
 2. When using a Leslie Switch CU-1, connect the CU-1 to the FOOT SWITCH jack.
- NOTE: This illustration shows only the Pedalboard expansion. See P.16 for the basic hook up of the power source, audio, etc.**
3. Switch ON the power of SKX and call the MIDI template “Pedal KBD”. (P. 112)
 4. If you are using the CU-1, set the CONTROL - FOOT DEVICE” at “CU-1”. (P. 76)



**GETTING READY
TO PLAY**

HOW TO POWER ON

After making the necessary connections, follow the procedures below for powering on your SKX. Please be sure to adhere to the procedure, to prevent malfunction or damage.

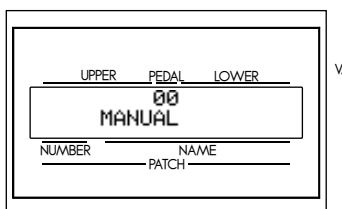
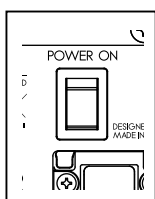
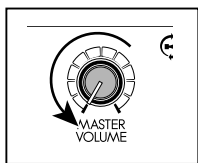

◆ PROCEDURES

1. Before turning the power ON, confirm the [MASTER VOLUME] knob is set to minimum.
2. Turn the [POWER] (on the rear of SKX) to the "ON". The Title mode and then the Play mode are displayed (as illustrated).

NOTE: For protecting the circuits, the SKX is designed not to play immediately at the power on (about 6 seconds).

3. Turn the power to the connected amplifier etc. "ON".
4. Play a bit, raising the [MASTER VOLUME] knob to adjust the volume to your needs.

NOTE: The [MANUAL] button does not sound in the default settings. Pull out the Drawbars or select any of the FAVORITE [1] to [10] buttons to get sound.

5. Adjust the volume of amplifier etc.

NOTE: To turn "OFF" the power, do the above steps in reverse. (Turn "OFF" the amplifier etc. first.)

BACK UP

The SKX "remembers" the unit's status immediately before the power is turned off, returning the unit to that status upon the next power-on.

The status of the default settings are the same as when the Favorite button [1] is depressed.

AUTO POWER OFF

The SKX has an "AUTO POWER OFF" feature which will automatically turn the power on the SKX "OFF" if no keys or buttons are pressed for 30 minutes.

To enable or disable the AUTO POWER OFF function, see "SYSTEM" P. 102.

NOTE: Depending on the status of SKX, while editing, for example, the power may not turn off, even if the set time of AUTO POWER OFF elapses. So make sure to turn the "POWER" switch OFF manually, after every use.

RESET TO THE FACTORY SETTINGS

To reset all parameters of SKX to its default settings, do the following:

◆ OPERATION PROCEDURES

1. Switch the [POWER] of SKX off.
2. Holding down the [RECORD] button, switch the [POWER] ON.
3. Keep holding down the button until "Loading Default..." is displayed.
4. When the Play mode is displayed, this operation is completed.

There are 100 Patches loaded in memory from the factory, allowing you to immediately start playing. You can also create 100 Patches of your own.

“USER” AND “PRESET”

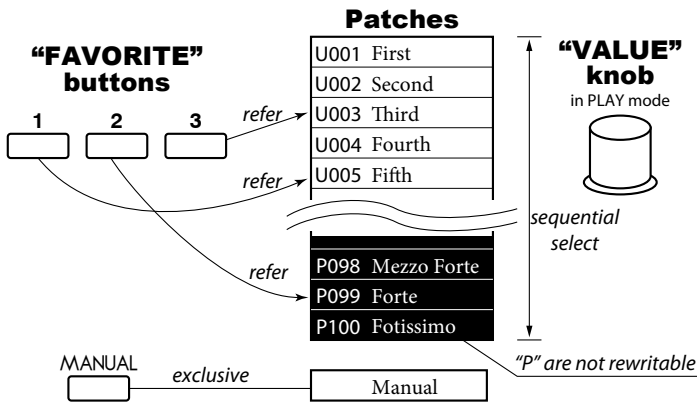

There are two domains: “USER” and “PRESET” in SKX’s Patch memory. You can freely overwrite in the “USER” domain, but you can not do so in the “PRESET” domain as it contains the factory settings.

“USER” and “PRESET” are indicated by “U” and “P” respectively.

HOW TO CALL A PATCH

Example: Select U041.

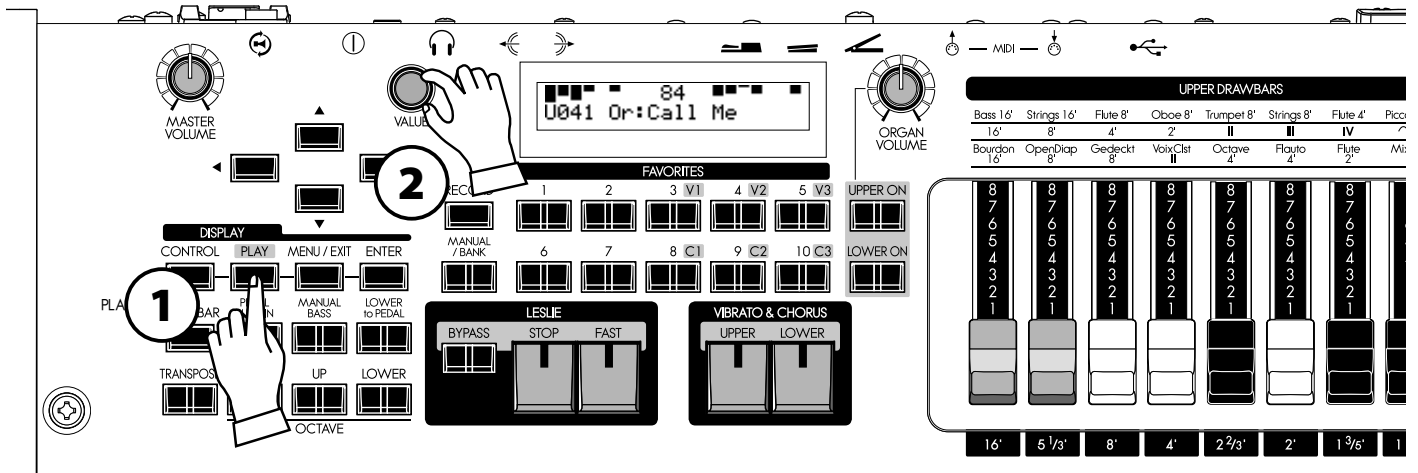

① GO TO THE PLAY MODE

Select the PLAY button, to enter PLAY mode.

② SELECT THE PATCH NUMBER

Select the Patch number U041 with the [VALUE] knob. Read the [PRESET PATCH LIST] (P. 138) in the Appendix for the Preset Patch details.

Call various Patches to play. When you call Patches, not only the Drawbar registrations but the effects such as Leslie, reverb, and Extra Voices also change.

NOTE: You can set the types of parameters to call (P. 74 #2 to 10).

NOTE: You can set the FAVORITE buttons to select a Patch with direct key-in (P. 74 #11)

REGISTER FAVORITE PATCHES (FAVORITES)

Patches are selected with the [VALUE] knob. On stage, it is convenient to have your favorite Patches available immediately. Here's how:

Register PATCHES to FAVORITES

Ex. Register U041 to "3-2"

1 SELECT THE PATCH

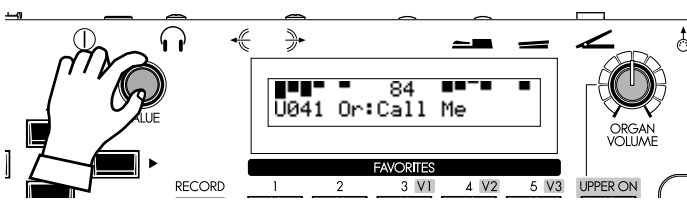

Select the Patch you want to register (in this example, U041) to a favorite button as shown on the previous page.

2 SELECT THE BANK TO REGISTER

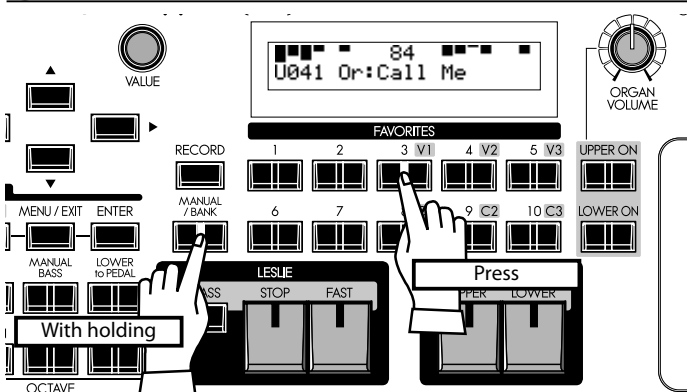

Press the Favorite button corresponds to "BANK" (in this example, [3]) with holding the [MANUAL/BANK] button.

NOTE: The Favorite button displays the Bank while the [MANUAL/BANK] button is held down.

NOTE: It is not necessary if you do not change the Bank.

3 SELECT THE NUMBER TO REGISTER

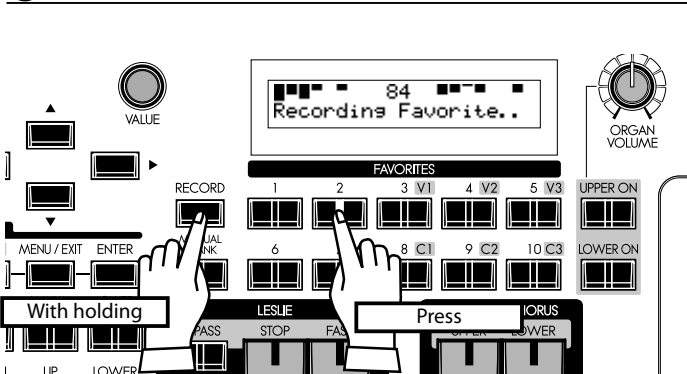

Finally, press the desired Favorite button corresponds to "NUMBER" (in this example, [2]), holding down the [RECORD] button.

The display will show "Recording Favorite.." for approximately 1/2 second, and the selected Favorite button will blink momentarily. Your Favorite is stored.

How to recall FAVORITES

Ex. Call the "3-2"

1 SELECT THE BANK

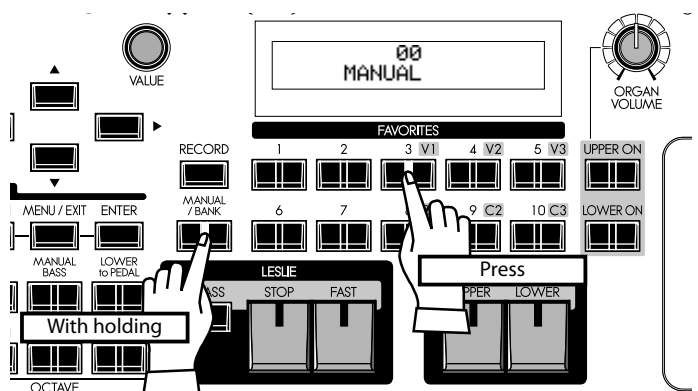

Press and hold the [MANUAL/BANK] button and select one of the numbered Favorite buttons corresponds to "BANK" (for this example, [3]).

NOTE: The Favorite button displays the Bank while the [MANUAL/BANK] button is holding.

NOTE: It is not necessary if you do not change the Bank.

2 SELECT THE NUMBER

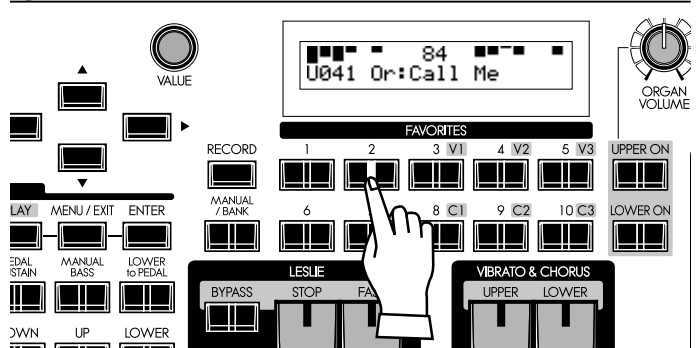

Press the Favorite button "NUMBER" (in this example, [2]) you wish to recall. The Favorite button lights and the corresponding Patch is called.

BANK and NUMBER

Number	1	2	3
Bank	1	2	3
1	U011 Born Verse	U012 Born Solo	U011 Born Verse
2	U024 MyLife Pf	U045 Lucy Org	U023 GetBack EP
3	P061 Classic	P062 Slow	P063 Contemp.

The "BANK" and "NUMBER" are method of managing number of Favorites efficient. They are used to be registered like the above chart according to song or show advance.

Column: RECORD FAVORITES LIKE PRESET BUTTONS

You can record a Favorite Patch with a procedure similar to the Hammond XB/XK series organs, by holding the [RECORD] button, and pressing the selected favorite button - after doing the following procedure.

1 LOCATE THE MENU MODE

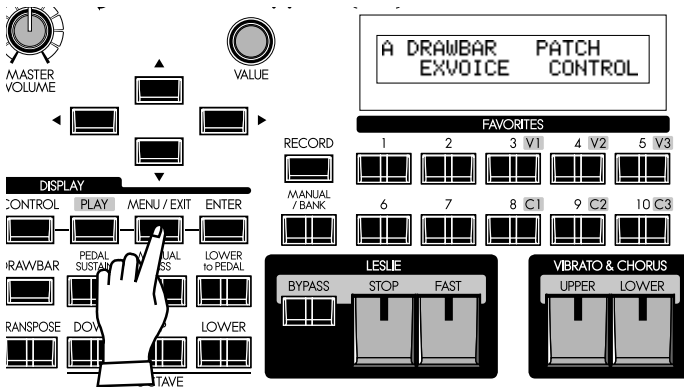

Press the [MENU/EXIT] button. The Menu mode appears. Repeat-press the menu button until the “A” menu appears (if necessary).

2 SELECT THE PATCH

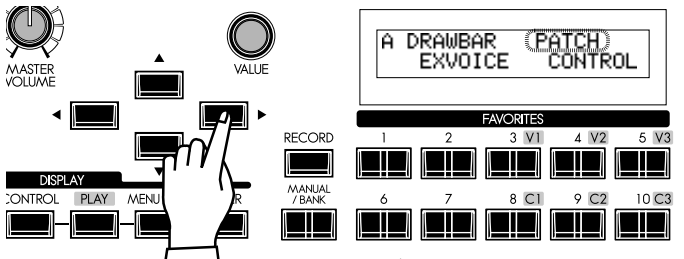

Press the [▶] buttons to select the PATCH option (it will blink).

3 ENTER

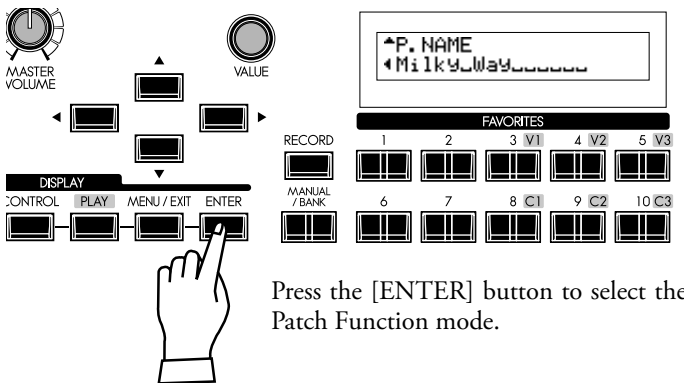

Press the [ENTER] button to select the Patch Function mode.

4 GO TO THE FAVORITE PAGE

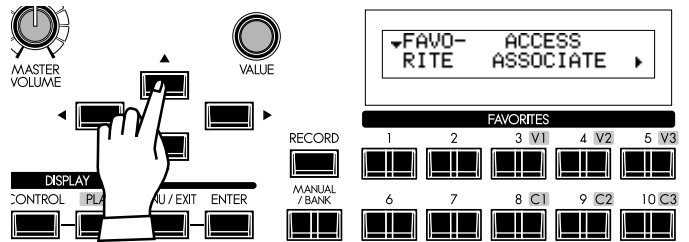

Press the [▲] button twice. The Favorite page appears.

5 SET VALUE TO LOCKED1-10

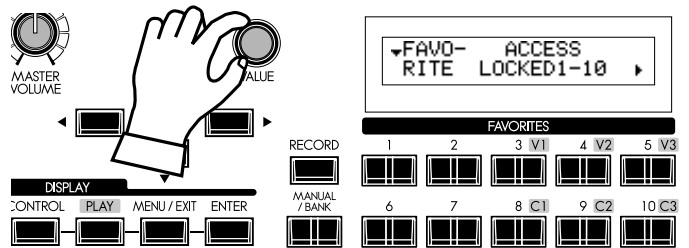

Turn the [VALUE] knob and set the value of the item ACCESS to “LOCKED1-10”.

6 RETURN TO THE PLAY MODE

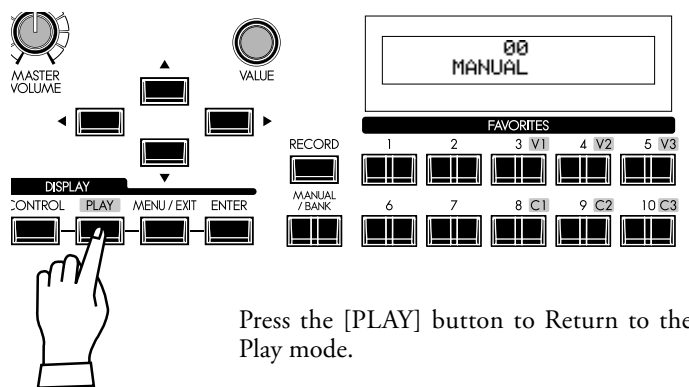

Press the [PLAY] button to Return to the Play mode.

USE THE FOOT CONTROLLERS

Expression and sustain are important elements in any performance. Here you'll learn how to connect these controllers.

EXPRESSION PEDAL

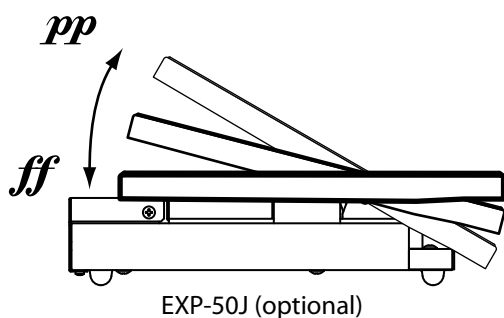

The Expression Pedal controls the overall volume or loudness of the SKX. Press forward with the front of your foot to increase the volume and back with your heel to decrease the volume.

NOTE: The performance of the Expression pedal can be tailored in various ways. (P. 77)

NOTE: You can control whether or not you want the Extra Voice sections to receive Expression. (P. 75)

FOOT SWITCH

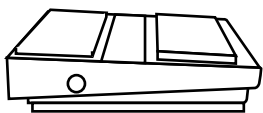

The Foot Switch can be programmed to various functions. The default setting is [LESLIE S/F ALTERNATE]. Every press toggles, the speed of the Leslie effect to fast or not.

NOTE: For information about how to set the Foot Switch function assignment. (P. 76)

DAMPER PEDAL

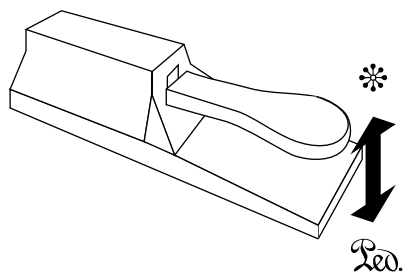

The Damper Pedal holds the played notes as same as acoustic piano.

You can hold the notes during change the chord without interrupt sound.

NOTE: You can change the part assignment of the Damper Pedal. (P. 76)

In this section you'll learn how to create your own sound. In this example, the Organ and Extra Voices are combined (Jazz Organ and Electric Piano).

SELECT [MANUAL]

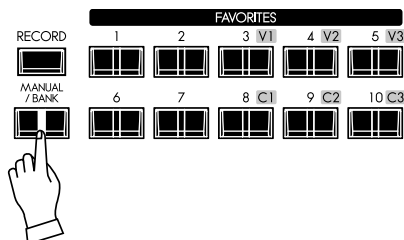

First, select the [MANUAL] button (LED lit).

The [MANUAL] button makes all the current top panel settings active, allowing for real-time registration, and the creation of new Patches.

NOTE: To return to the Patch, press the [MANUAL] button again (LED off).

Column: INITIALIZE THE INTERNAL SETTINGS [MANUAL]

When the [MANUAL] button is "ON", some parameters which does not on the panel (e.g. Organ Type) may set at undesired value. This is the procedure to return them to the DEFAULT status.

1 GO TO THE MENU MODE

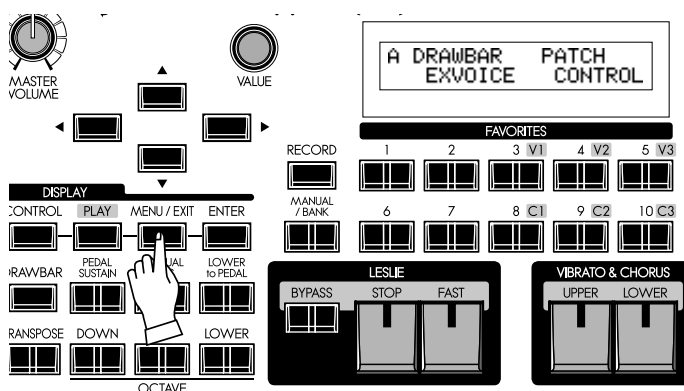

Press the [MENU/EXIT] button. The Menu mode appears. If the display is different from the above illustration, select the [MENU/EXIT] button again.

2 LOCATE PAGE E

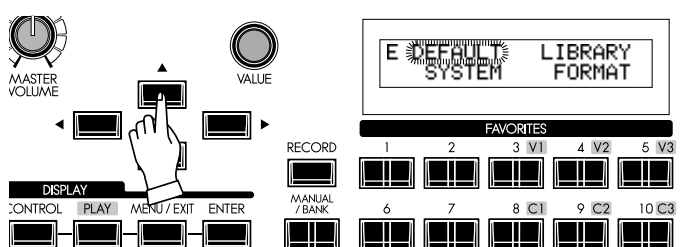

Press the [▲] button 4 times reaching Page E. The DEFAULT entry is blinking.

3 ENTER

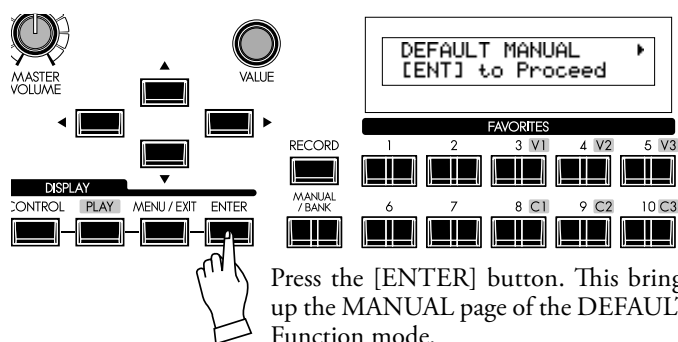

Press the [ENTER] button. This brings up the MANUAL page of the DEFAULT Function mode.

4 ENTER AGAIN

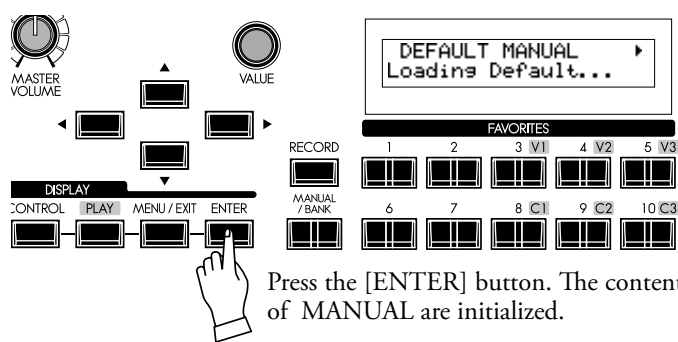

Press the [ENTER] button. The contents of MANUAL are initialized.

5 RETURN TO THE PLAY MODE

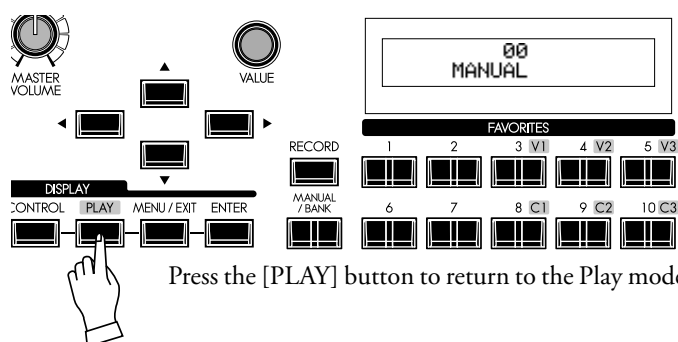

Press the [PLAY] button to return to the Play mode.

SWITCH THE ORGAN SECTION ON

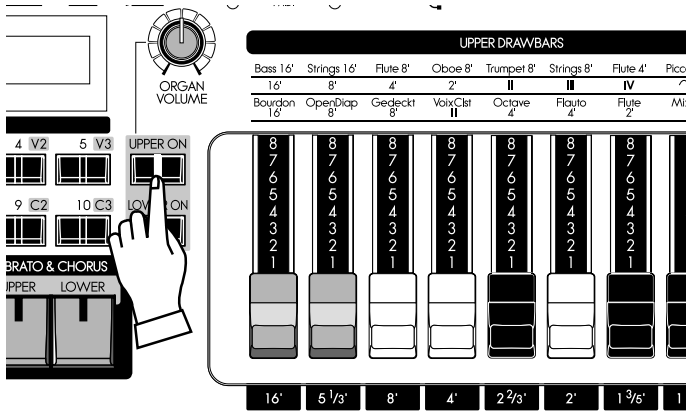

In this example, make sounds to begin with the Organ Section. The ON buttons switches sounds or does not at each part for the Organ Section.

NOTE: What is a "PART"? (P. 32)

Switch the [UPPER ON] button "ON". The UPPER part of the Organ Section will sound.

NOTE: You can set that the Extra Voice Section turns off automatically by the Organ Section is switched on. (P. 79)

Next, set the [ORGAN VOLUME] knob. It adjusts the overall volume for the Organ Section. Set this knob in the center position at this time.

PULL OUT DRAWBARS

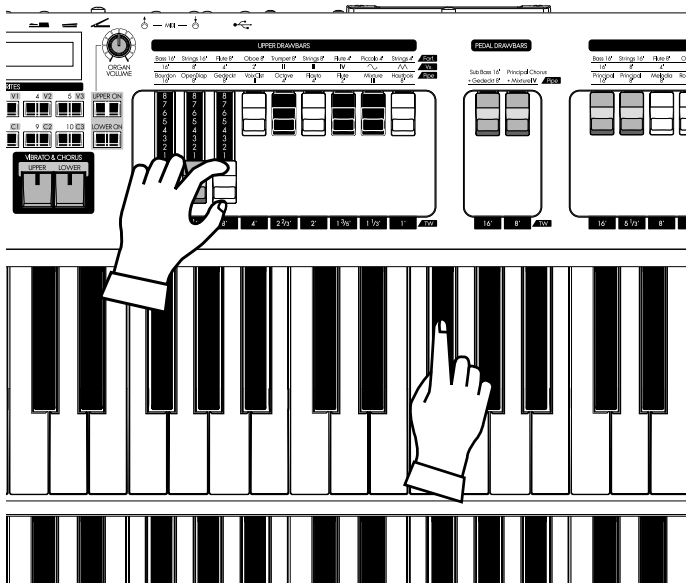

Pull out Upper Drawbars to your taste. You can monitor your selections easily while playing the keyboard.

The Drawbars make the fundamental organ sound of SKX. The tone changes depending on how far the Drawbars are pulled out.

The volume of each sound becomes maximum when the Drawbar is fully pulled out, and null when fully pushed back. The drawbars are arranged so that the pitch grows higher from left to right.

For this example, pull the first three Drawbars out all the way as shown in the illustrated on the left 16', 5 1/3' and 8'.

NOTE: You can change the sound character of the Drawbars. (P. 72)

NOTE: The present registration is displayed in the Play mode. (P. 63)

ADD THE TOUCH-RESPONSE PERCUSSION

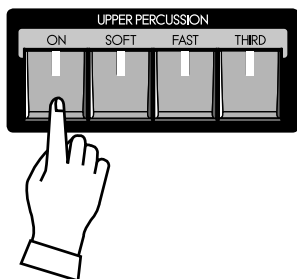

Hammond's Touch-Response Percussion adds a distinctive attack to the Tone Wheel/Drawbar tones. This Percussion is not like a drum or cymbal, but closer to an xylophone or marimba. [PERCUSSION] is available only on the UPPER part.

To enable the Percussion, turn the [ON] button "ON".

The [SOFT] button reduces the volume of the Percussion voice and [FAST] button quickens the decay of the Percussion voice.

There are two choices of pitch for Percussion. One sounds an octave above the note played ("Second"), and another sounds a "twelfth" above. ("Third") - When the [THIRD] light is off "Second" is selected.

For this example turn all of the Percussion buttons "ON" ([ON], [SOFT], [FAST], [THIRD]).

NOTE: You can fine-tune the Percussion parameters to your taste. (P. 80)

ADD EFFECTS TO THE ORGAN SECTION

VIBRATO & CHORUS

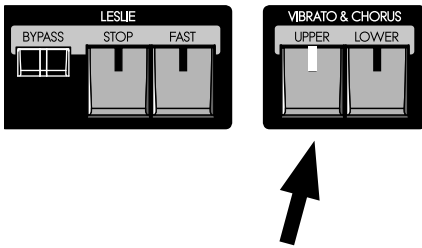

Adding a richness to the sound by changing pitch slightly with periodically.

[UPPER], [LOWER] buttons

Switches the Vibrato & Chorus effect ON/OFF. When “ON” the light illuminates.

NOTE: You can adjust the Vibrato & Chorus effect to your liking. (P. 81)

For this example, switch ON the [UPPER] button.

LESLIE

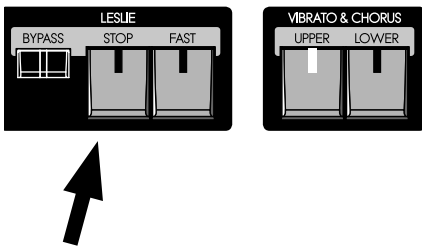

The LESLIE effect is the famous “Moving and Swirling” sound provided by rotating horns and speakers, but executed here in the Digital realm.

[FAST] button

This button toggles the mode of the Rotor to fast or not. When the light is “ON”, it is FAST, and when “OFF”, not.

[STOP] button

This button sets the mode when the [FAST] button is off. When the light is “ON”, it is STOP, and when “OFF”, it is SLOW.

[BYPASS] button

To engage the Leslie effect, press the [BYPASS] button turning the light “OFF”.

NOTE: These controls perform the same functions when a Physical Leslie is connected via the 11 pin socket.

NOTE: You can fine-tune the parameters of the Digital Leslie effect etc. (P. 82)

For this example, let's set the status of all lights “OFF”.

OVERDRIVE

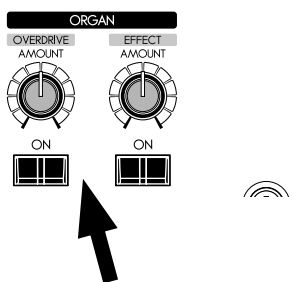

The Overdrive section adds warmth at low settings, and “grit” or distortion at higher.

[ON] button

Toggles the Overdrive “OFF” and “ON” (when on the light is illuminated).

[AMOUNT] knob

Adjusts the amount of Overdrive. The amount increases as you rotate the knob clockwise.

In this example, the Overdrive is not used. The Button light should be “OFF”.

MULTI-EFFECTS

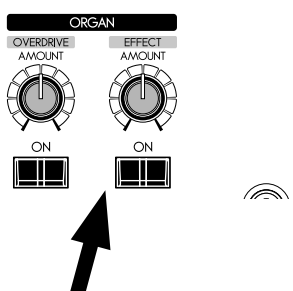

Adjusts the amount of the selected Multi-effect to be applied to the Organ section. The default settings: at “Tremolo”.

[ON] button

Toggles the Multi-Effects “OFF” and “ON” (when on the light is illuminated).

[AMOUNT] knob

Adjusts the amount of Multi-Effect to be applied. The amount increases as you rotate the knob clockwise.

In this example, the Multi-Effects are not used. The Button light should be “OFF”.

ALLOCATING THE EXTRA VOICES

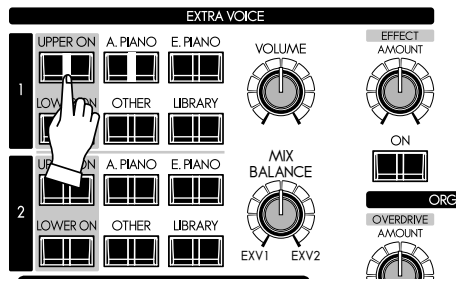

Choose which parts will play the Extra Voices.

[UPPER ON] button

The Extra Voices play on the UPPER part.

[LOWER ON] button

The Extra Voices play on the LOWER part.

There are two Extra Voice sections. You can assign these either for Upper or Lower parts.

For this example, switch the [UPPER ON] button for EXTRA VOICE 1 at "ON".

NOTE: You can set that the Organ Voice Section turns "OFF" automatically by the Extra Voice Section is switched "ON". (P. 79)

SELECT AN INSTRUMENT

To choose the Extra Voice instruments, press the desired Voice Group button on the top panel, then select your specific instrument in the display.

Select the "EPiano Rd2" as follows.

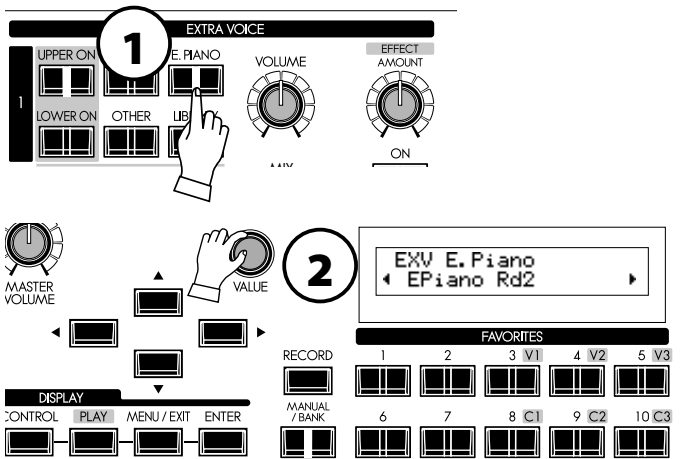

1 SELECT A VOICE GROUP

Press the [E.PIANO] button.

An instrument what used previously in the selected voice group will selected automatically.

2 SELECT AN INSTRUMENT

Select "EPiano Rd2" with the [VALUE] knob.

Now the "EPiano Rd2" is ready to play.

Column: To select the other group (e.g. "Wind")

The voice group "Wind" is hidden behind the [OTHER] button. To select this;

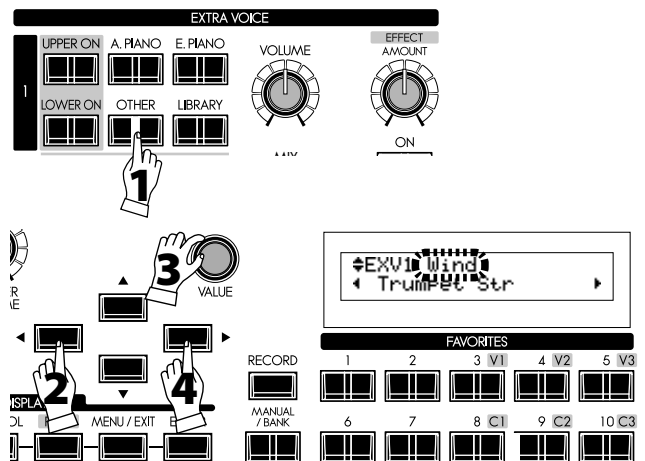

1. Press the [OTHER] button.
2. Locate the cursor at voice group with the [◀] button.
3. Select the "Wind" with the [VALUE] knob.
4. Locate the cursor at instrument with the [▶] button.
or, Press the [OTHER] button several times after step 1.

ADJUST THE VOLUME BALANCE

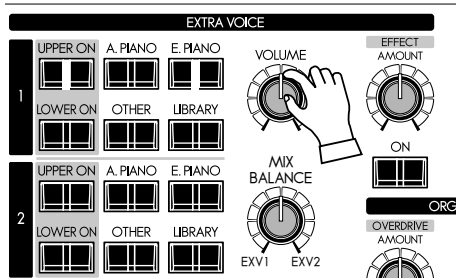

To achieve your desired blend of Organ and Extra Voice (In this example the E. Piano), adjust the Extra Voice volume knob accordingly.

The [VOLUME] knob adjusts entire volume of the Extra Voice sections.

The [BALANCE] knob adjusts the volume balance between Extra Voice sections 1 and 2.

ADD EFFECTS TO THE EXTRA VOICE SECTION

MULTI-EFFECTS

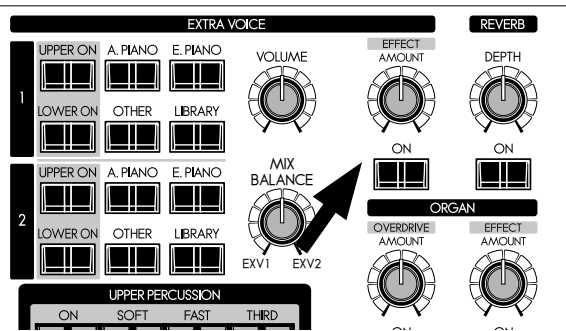

The most suitable effects for each Extra Voice are automatically called when selecting that voice.

[ON] button

Adds effects to the Extra Voices. When “ON” the light is illuminated.

[AMOUNT] knob

Adjusts the amount of effect added. Turning the knob clockwise increases the amount.

ADD REVERB TO BOTH SECTIONS

REVERB

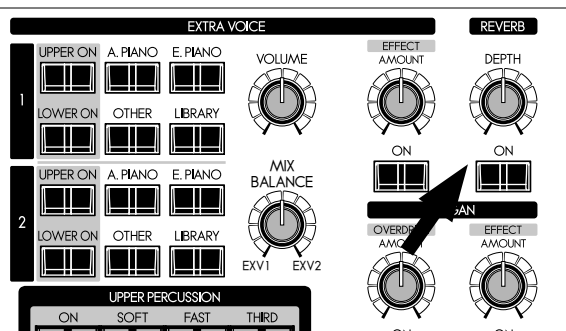

The SKX’s Digital Reverberation is common to both Organ and Extra Voice sections.

[ON] button

Turns the Reverb effect ON.

[DEPTH] knob

Adjusts the amount of Reverb added. Turning the knob clockwise increases the amount.

WHAT IS A "PART"?

Each "PART" is equivalent to a player in a band or an orchestra. The 3 Parts here are expressed in Organ terms: UPPER, LOWER, and PEDAL. These parts can be individually played with different sounds.

The SKX has 2 keyboards. All parts are available simultaneously, by expanding the MIDI Pedalboard.

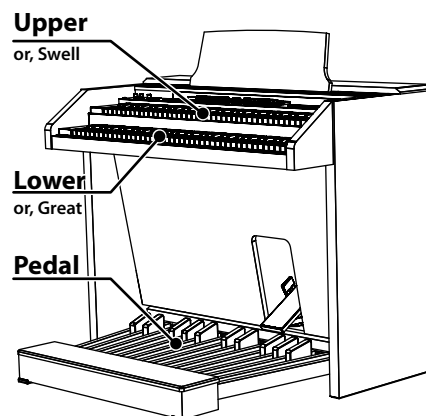

MANUAL BASS

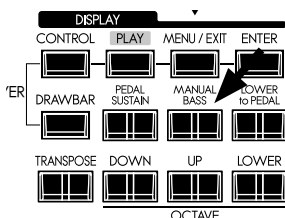

Manual Bass

You can play the PEDAL voices using the lowest notes of the LOWER keyboard.

[MANUAL BASS] button

To use the Manual Bass function, press the [MANUAL BASS] button and the light will go ON. The PEDAL/Bass sound is heard in conjunction with the lowest note being played, on the manual keyboard till that time.

In order to interface with the melody performance, the default Manual Bass upper limit point is set to sound up to, and including middle "B".

NOTE: The Manual Bass can be set to play in Lowest, Polyphonic, and Chord (P. 110). You can change the playing range of the Manual Bass (the upper limit) (P. 110).

The part obtained when the Manual Bass is selected is called PEDAL part and its sound is controlled by the Drawbars ([PEDAL] when selected in Drawbar Select). This is originated from the style of playing bass on the pedal keyboard of a 3 keyboard type organ.

You can use both the manual bass and the split at the same time. This makes it possible to play the bass + chord + melody only by yourself.

NOTE: You can triggering the Manual Bass by foot switch (P. 76).

LOWER TO PEDAL

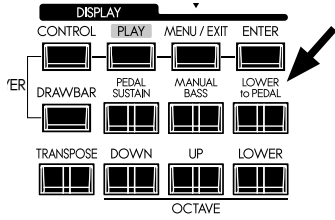

Lower to Pedal

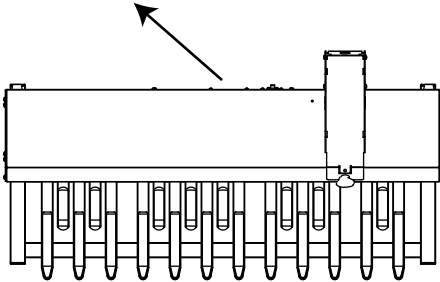

When a MIDI Pedalboard is connected to the SKX, you can play the LOWER part sound (or “registration”) with the Pedalboard using the “LOWER TO PEDAL”.

[LOWER to PEDAL] BUTTON

Turns the Lower To Pedal function “ON” (LED lit) and “OFF” (LED not lit).

The default upper limit for Lower to Pedal is below Middle “B”.

NOTE: You can change the playing range (the upper limit) of the ‘Lower to Pedal’. (P. 110)

PEDAL SUSTAIN

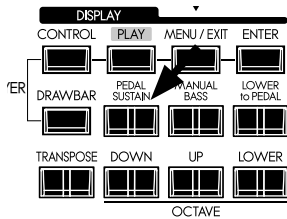

When the [PEDAL SUSTAIN] button is “ON”, the PEDAL tones will smoothly decay upon release, much in the manner of a string bass. This is a popular option for playing the PEDAL tones.

[PEDAL SUSTAIN]

Turns Pedal Sustain “ON” (LED lit) and “OFF” (LED not lit).

After releasing your foot from a Pedal note (or releasing your finger from the LOWER key when you are using Manual Bass, the sound will slowly fade, or decay.

NOTE: You can adjust the Pedal Sustain. (P. 73)

RECORD THE PATCH TO MEMORY

All the previous settings can be recorded to any Patch within the range of U001 to U100.

Example: RECORD TO U032

1 PRESS THE [RECORD] BUTTON

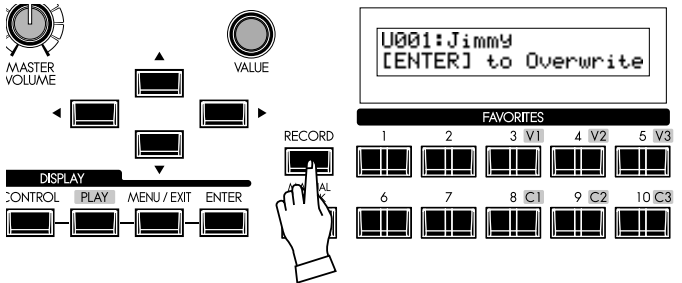

Press the [RECORD] button.

A prompt will appear in the display allowing you to select the Patch you want to record.

2 SELECT THE PATCH TO RECORD

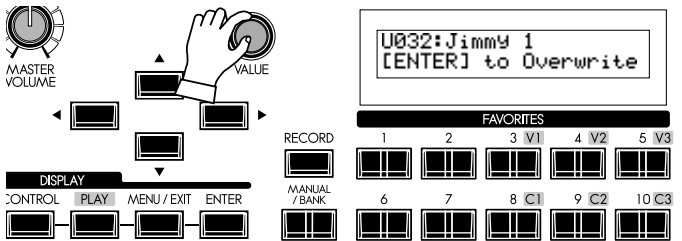

Select the Patch number, this time U032, to record, using the [VALUE] knob or type the buttons such as [3] [2].

3 PRESS THE [ENTER] TO DECIDE

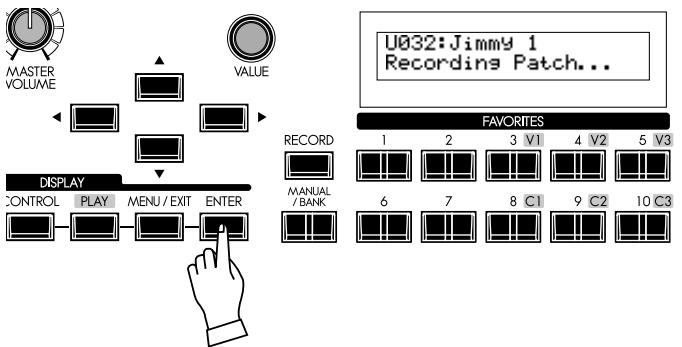

Press the [ENTER] button.

The Patch Number is decided and the display will show, "Recording Patch" for approximately 1/2 second, after which the previous mode will return.

The recorded Patch is automatically selected.

NOTE: The user created Patch data is not lost when the power is turned off and/or disconnected.



SOUND ENGINE STRUCTURE

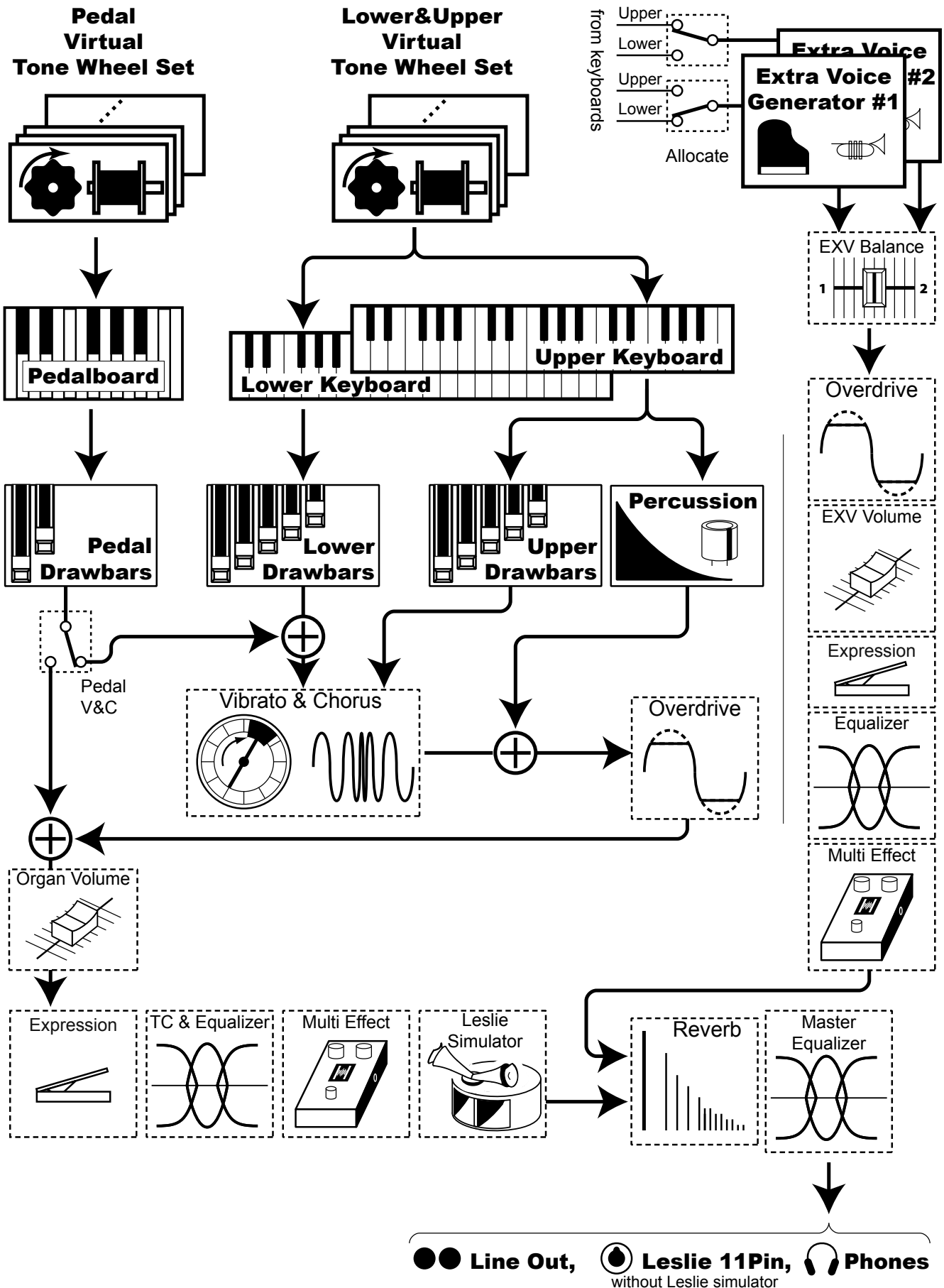

To fully utilizing SKX, read the following detailed explanations about the various functions for creating music.

ORGAN SECTION

TONE-WHEELS

The sound source or “engine” of the classic Hammond Organ are the electro-magnetic Tone Wheel Generators. On the SKX, the Tone Wheel engine is replicated digitally.

While the power is on, each of the 96 virtual Tone Wheels keeps oscillating as they did in the vintage Hammond Organs.

KEYS

The tone signals created with the 96 virtual Tone Wheels are “switched” at the keys.

To each key the signals corresponding to the pitch and harmonics (for example, 9 sets on the manual keyboard) are distributed, and when you touch or release a key, the switch connects or cuts the tone signals.

DRAWBARS

Each Drawbar represents a fundamental harmonic. Each bar adjusts the value of each harmonic. There are 9 drawbars corresponding to 9 different harmonics.

TOUCH-RESPONSE PERCUSSION

The Percussion creates a decaying sound on the UPPER manual.

VIBRATO & CHORUS

The Vibrato & Chorus gives depth and richness to the organ sound by slightly varying the pitch (Vibrato), or doubling the voice by mixing the original sound, with a duplicate, slightly detuned one (Chorus).

OVERDRIVE

The Overdrive creates distortion as if an amplifier was being driven beyond its limits.

MULTI-EFFECTS

The Multi-Effects create various effects such as tremolo and Wah.

EQUALIZER, LESLIE, REVERB

The built-in Effects are as follows: an Equalizer for sculpting the tonal response, a Leslie Effect for rotary speaker effects, and Reverb.

(The built-in Leslie Effect is disengaged when a physical Leslie is connected to the 11-pin terminal.)

EXTRA VOICE SECTION

SOUND ENGINE

The Extra Voice section is the sound engine for playing piano and other musical instruments. It is independent of the Organ Section.

EFFECTS

You can add Overdrive, Multi-Effects, Equalizer and Reverb to the Extra Voice Section.

MASTER EQUALIZER

The combined signal of Organ and Extra Voice is routed through the Master Equalizer. Allowing you to tailor your sound for the provided venue, amp, sound system or recording. The settings are not saved in Patch memory.

tips TONE-WHEEL SETS

The Tone Wheel Sets are divided into the Manuals and the Pedal Part. This is to give the Pedal Part the Decay (= the sound gradually fading out while pressing the key) or Sustain Effect. (= the sound gradually fading out after the key is released).

tips HARMONICS

Harmonic is a pitch of a different ratio to a certain pitch; for example, the one octave higher C to the middle C. The more Harmonics, the brighter and richer sound is obtained.

ORGAN TYPE

There are various "Organ" types: the Hammond Tone Wheel organs used in everywhere rock, jazz, and Gospel, the transistor organ frequently heard in pop music of 1960's. Classical pipe organ used in classical music or church services. All organs have characteristic sounds.

The SKX will sound like the types of organ you choose.

STONE-WHEELS (BType1, BType2, Mellow)

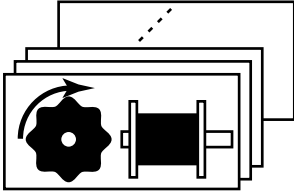

These are various types of Hammond Organs' characteristic Tone Wheels. The Hammond Organ's original purpose was to duplicate the pipe organ, however, they became famous for producing a unique sound of their own.

The BType1 and BType2 have the B-3/C-3's traditional Tone Wheel sounds. The BType2 has more wow-flutter and leakage noise.

The Mellow is not a Tone Wheel, if strictly speaking. It replicates the first-generation non-mechanical Transistor Hammond Tone Generators like the GT-7 and Concord.

TRANSISTOR (Vx, Farf)

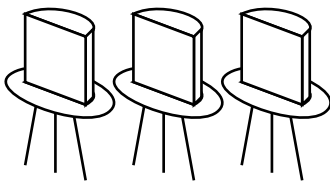

After the transistor became generally used, the light weight organs were introduced (such as Ace Tone TOP-6 etc.) using the transistor circuit instead of the Tone Wheels or tubes. The circuit system is different from maker to maker or model by model. We have replicated 2 representative types here.

The Vx is a type to combine the triangle wave and square wave with several footages. The Farf is one to combine the sound wave forms coming through plural filters with the tablet switch.

PIPE

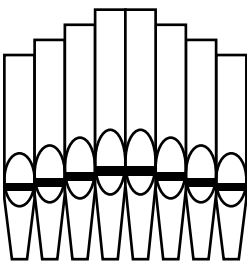

The pipe organ produces sounds by oscillating the air sent through the pipe. The name of Stops tells you which wind instruments that you are duplication.

You can create other sounds by combining different organ Stops, in the same way Drawbars are used on the SKX.

Column: SELECTING THE ORGAN TYPES

Use the control panel for switching the Organ Types.

Example: Switching the Organ Type to “Pipe”

1 PRESS THE [DRAWBAR]

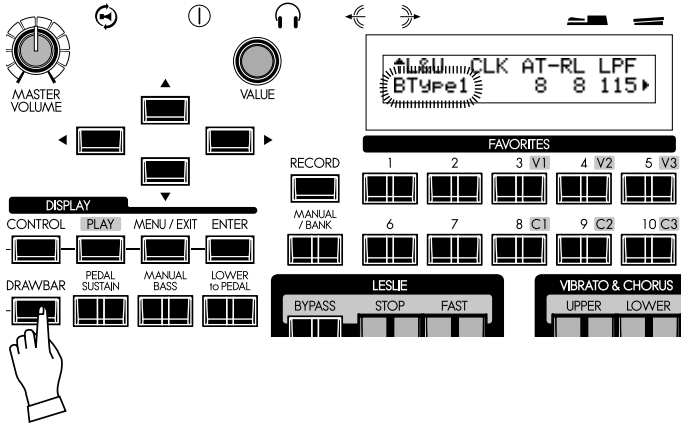

Press the [DRAWBAR] button. The DRAWBAR Function mode is displayed and the presently selected Organ Type (“BType1” etc.) of the manual keyboard will blink.

2 SELECT THE ORGAN TYPE

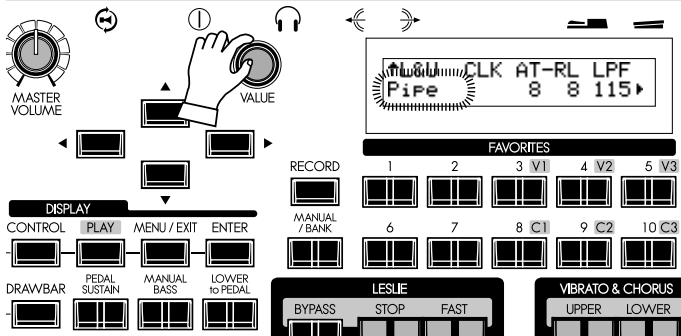

Select “Pipe” with the [VALUE] knob. The pipe organ sounds when you play the notes from the Organ section.

NOTE: Though this page is for Lower and Upper part, the Organ Type “Pipe” switches Pedal part also from other types to “Pipe” type.

3 RETURN TO THE PLAY MODE

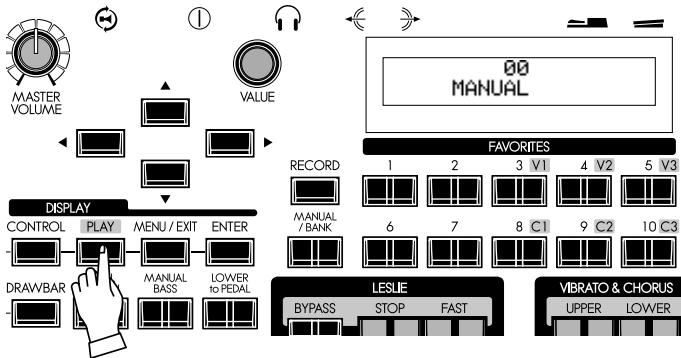

To return to the Play mode, press the [PLAY] button.

HARMONIC DRAWBARS™

The 9 Drawbars on the SKX are used to create the basic “Hammond” sounds. Each Drawbar is marked with the register numbers 1 - 8 along the flat part of the Drawbar. If you push back a Drawbar until you cannot see any number at all, the sound of the Drawbar is not heard. If you pull it out to the fullest position the sound level is maximum.

When recalling a Patch, the drawbars’ “positions” will change internally, but not physically. However, if you move a drawbar, the setting will “snap” to that drawbars current position. The [MANUAL] or [PRIO] keeps matched Drawbar registration.

DRAWBARS (ON TONE-WHEEL: BType1, BType2, Mellow)

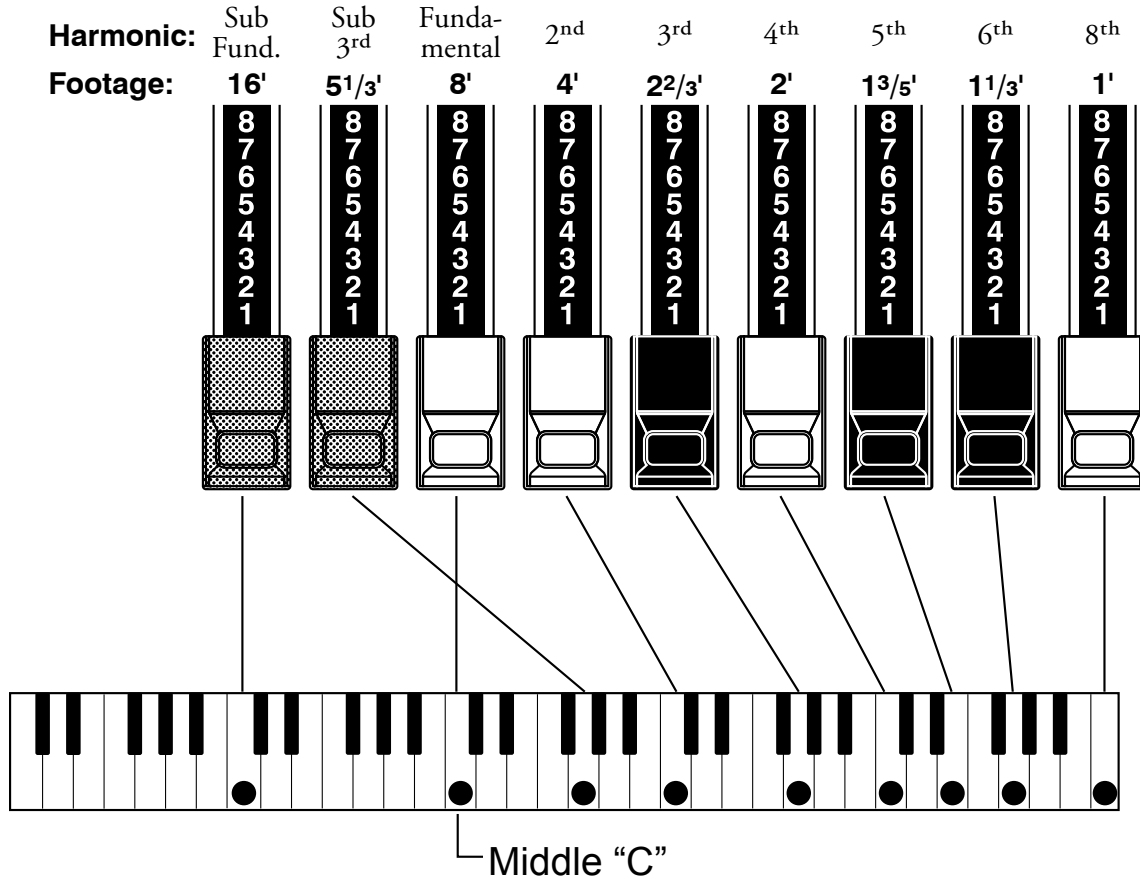

The pitch of each Drawbar is as shown above, when the middle C is depressed. The footage marked (') on the handle end of each Drawbar is derived from the corresponding length of pipes of a pipe organ.

The numbers 1 - 8 on the “bar” portion of each Drawbar indicate the volume of the sound to be produced as well as the guide to remember Drawbar settings.

Pull the fundamental (8'), the third harmonic (2 2/3') plus the fifth harmonic (1 3/5') Drawbars out completely and play the keyboard. Notice how the sound resembles a clarinet.

If you push the 8' Drawbar half-way, you'll notice the sound becomes more high-pitched and a bit “harder”. Now pull the 8' Drawbar back out fully and push the 2 2/3' and 1 3/5' in halfway. Notice how the sound becomes mellower.

Experiment with the Drawbars to obtain your own personal favorite sounds.

tips DRAWBAR REGISTRATION

The lengths of the pulled out Drawbars.

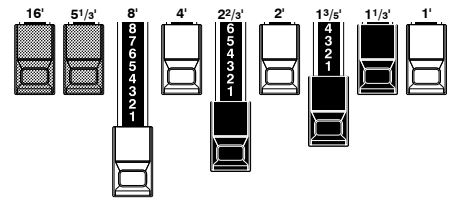

Example of “Clarinet”



In the case of the Tone Wheel Organ, refer the correspondence between each bar and the footage to the “TW” row in front of the Drawbars.

DRAWBARS FOR THE UPPER AND LOWER PARTS

The Colors of the Drawbars are traditional to Hammond, and were established to provide a quick visual guide to the harmonics generated by the Drawbars.

WHITE DRAWBARS

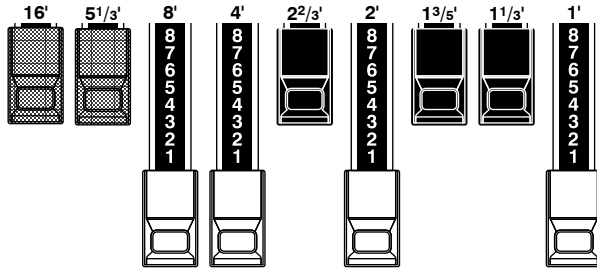

The left white Drawbar represents the “fundamental” or “8’ base” tone. All of the other white Drawbars are octave intervals or harmonics of the fundamental tone. The tonal brilliance is greatly increased by adding white Drawbars, but the harmonics added are always in “consonance” or harmony.

BLACK DRAWBARS

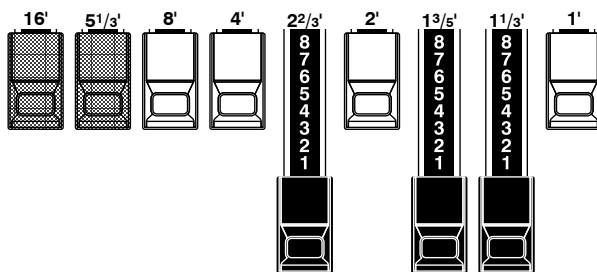

The black Drawbars represent the “dissonant” harmonics which are also necessary in building rich tone colors. The mellowness of a horn, the pungency of strings, and the brilliance of reed voices owe much of their character to the presence of these harmonics in different degrees.

BROWN DRAWBARS

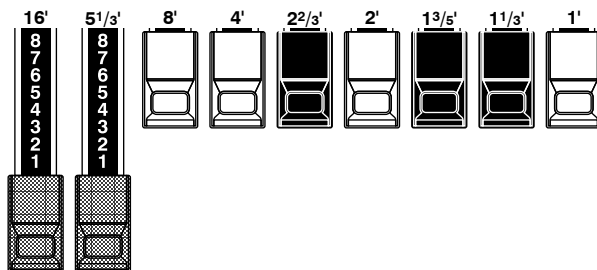

The two brown Drawbars on the far left give depth and richness to the sound. The left 16’ is one octave lower than the 8’, and 5 1/3’ is the third harmonic of the 16’ fundamental. Normally, the tones are built on the 8’ fundamental, but, if you want to add depth to the tone or to expand the playing range by one octave lower, build your tones on the 16’ fundamental.

DRAWBARS TO USE ON THE PEDAL

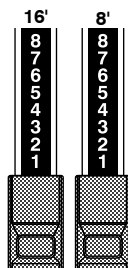

The two brown Drawbars located between the Drawbars for the Upper and Lower parts control the sounds produced by the Pedal part. The left Pedal Drawbar produces a composite tone at 16’ pitch for a deep foundation bass, while the right Pedal Drawbar produces a composite tone at 8’ pitch, or one octave higher.

DRAWBAR REGISTRATION PATTERNS

Regardless of the size of a pipe organ or its number of stops, all of its voices are related to four basic families of tone. The four basic families - Flute, Reed, String and Diapason - can be quickly set up on the Drawbars by relating a pattern or shape to each family.

Flute family (2 step pattern)

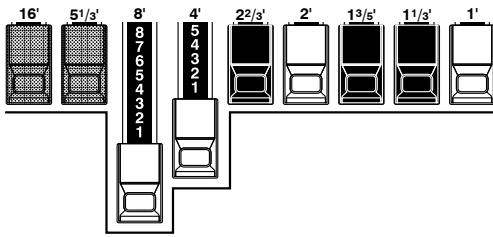

Accompaniment Flute 8' I.....	00 8460 000
Accompaniment Flute 8' II.....	00 3220 000
Accompaniment Flute 8' III.....	00 8600 000
Chorus of Flutes 16'.....	80 8605 002
Orchestral Flute 8'.....	00 3831 000
Piccolo 2'.....	00 0006 003
Stopped Flute 8'.....	00 5020 000
Tibia 8'.....	00 7030 000
Tibia 4'.....	00 0700 030
Tibia (Theater) 16'.....	80 8605 004
Wooden Open Flute 8'.....	00 8840 000

Diapason family (check mark pattern)

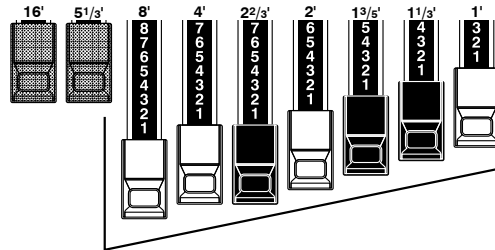

Accomp. Diapason 8'.....	00 8874 210
Chorus Diapason 8'.....	00 8686 310
Diapason 8'.....	00 7785 321
Echo Diapason 8'.....	00 4434 210
Harmonic Diapason 16'.....	85 8524 100
Harmonic Diapason 8'.....	00 8877 760
Harmonic Diapason 4'.....	00 0606 045
Horn Diapason 8'.....	00 8887 480
Open Diapason 8'.....	01 8866 430
Solo Diapason.....	01 8855 331
Wood Diapason 8'.....	00 7754 321

Reed family (triangle pattern)

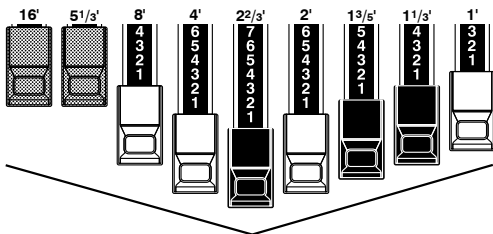

Bassoon 16'.....	44 7000 000
Clarinet 8'.....	00 6070 540
English Horn 8'.....	00 3682 210
Flugel Horn 8'.....	00 5777 530
French Horn.....	00 7654 321
Kinura 8'.....	00 0172 786
Oboe 8'.....	00 4764 210
Trombone 8'.....	01 8777 530
Trumpet 8'.....	00 6788 650
Tuba Sonora 8'.....	02 7788 640
Vox Humana 8'.....	00 4720 123

String family (bow pattern)

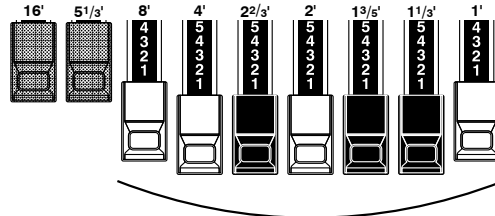

Cello 8'.....	00 3564 534
Dulciana 8'.....	00 7770 000
Gamba 8' I.....	00 3484 443
Gemshorn 8'.....	00 4741 321
Orchestral String 8'.....	00 1464 321
Salicional 8'.....	00 2453 321
Solo Viola 8'.....	00 2474 341
Solo Violin 8'.....	00 3654 324
Viola da Gamba 8'.....	00 2465 432
Violina 4'.....	00 0103 064
Violone 16'.....	26 3431 000

Notice that Drawbar registrations are expressed in number groups of 2, 4 and 3. This "2-4-3" number formula for Drawbar Registration has been a Hammond convention since the beginning. It has been found to be the easiest way to convey a specific setting. The first two numbers correspond to the two brown Drawbars of either manual. The middle four numbers designate the 8', 4', 2 2/3', 2' Drawbars, and the remaining three numbers refer to the last three Drawbars.

MODERN DRAWBAR REGISTRATIONS

The Drawbar registrations introduced on the previous page are typically for classical music.

They were created at the dawn of the Hammond Organ, when it was intended to sound like a pipe or church organ. Later on, as the Hammond Organ spread throughout Jazz, Pop, Rock and (especially) Gospel music, Some timeless registrations become common.

Jazz

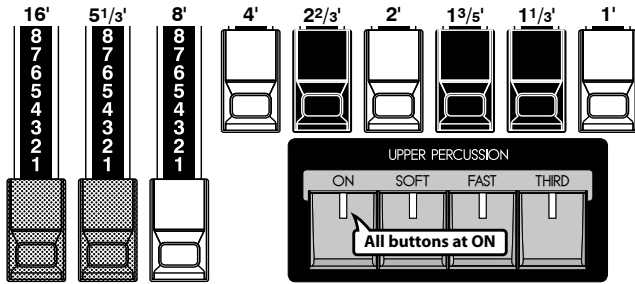

Bluesy

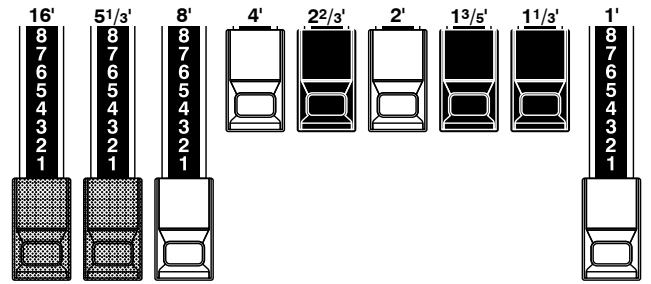

Groovy & Funky

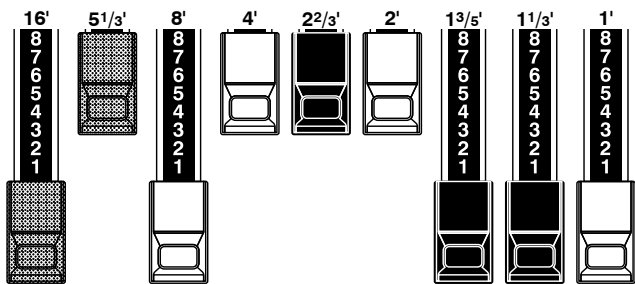

Max Power

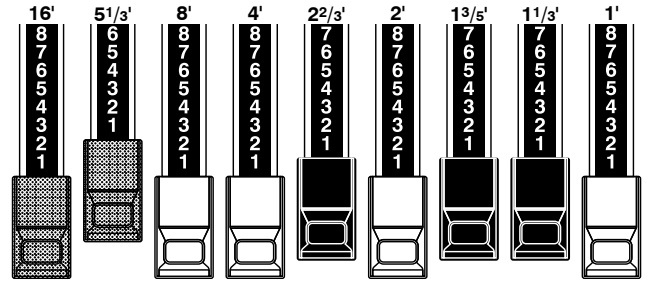

Squabble

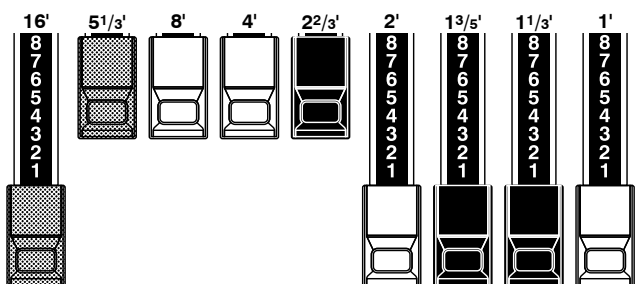

tips APPLICATION OF PERCUSSION

When Percussion is used, the sound of the 1' Drawbar is cancelled. As it was on the Vintage B-3/C-3. A trick is to keep the 1' drawbar fully out, and then turn the Percussion on and off as you play for an instant change in sound. Try it!

DRAWBARS (Vx)

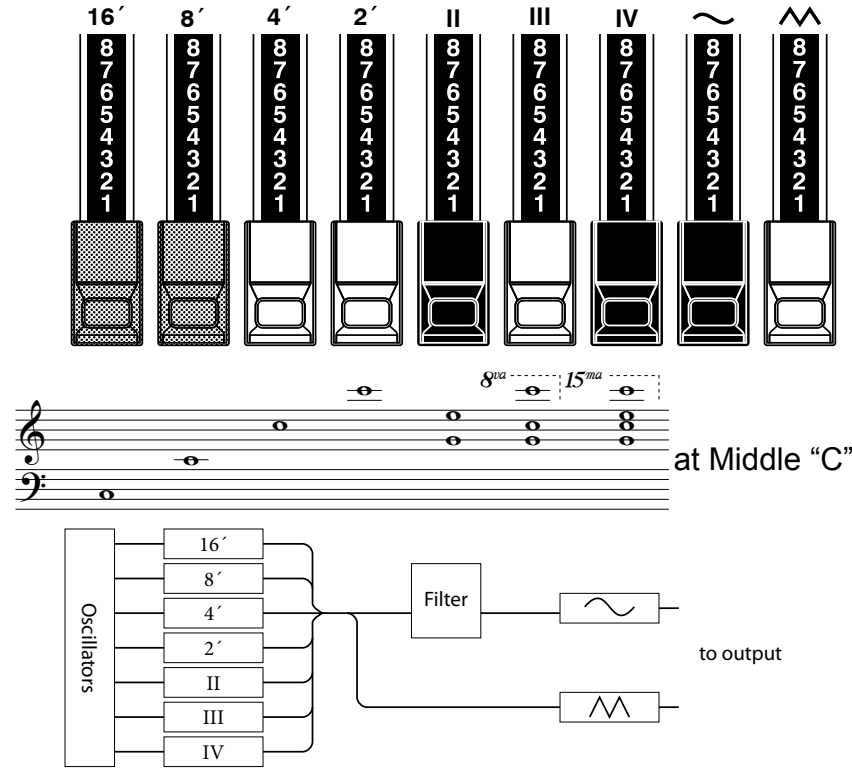

The type of combo organ replicated by British "Vx" mode had Drawbar-type controls, but they functioned differently from Hammond Harmonic Drawbars Organ. The left four Drawbars control individual pitches, while the next three are "Mixture" Drawbars which cause multiple pitches to sound. "II," "III" and "IV" refer to the number of pitches represented by that Drawbar.

The right two Drawbars control the type of tone produced by the first seven Drawbars.

The "~" Drawbar causes mellow tones to sound while the "^" Drawbar causes brighter and more harmonically complex tones to sound.

NOTE: The left seven Drawbars WILL NOT sound unless one or both of the right two Drawbars are also "out." These two Drawbars regulate the overall volume as well as timbre of the total Drawbar registration, and can be used separately or together.

tips FOOTAGE

"Footage" is a term inherited from the pipe organ. It is used to designate the pitch at which a particular organ stop will sound. The number refers to the length of pipe necessary to produce the lowest note of that particular stop.

For example, if a stop is marked 8' it means that the lowest note on a standard 5-octave organ keyboard "C" will require a pipe 8 feet long.

Bass 16'	Strings 16'	Flute 8'	Oboe 8'	Trumpet 8'	Strings 8'	Flute 4'	Piccob 4'	Strings 4'	Forf.
16'	8'	4'	2'	II	III	IV	~	^	Vx.
Bourdon 16'	OpenDiap 8'	Gedeckt 8'	VoixClist II	Octave 4'	FluteDolce 4'	Flute 2'	Mixture III	Hautbois 8'	Pipe

If the Organ Type is set to Vx, refer to the "Vx" row on the other side of the Drawbars for the correspondence between each bar and the footage.

DRAWBARS (Farf)

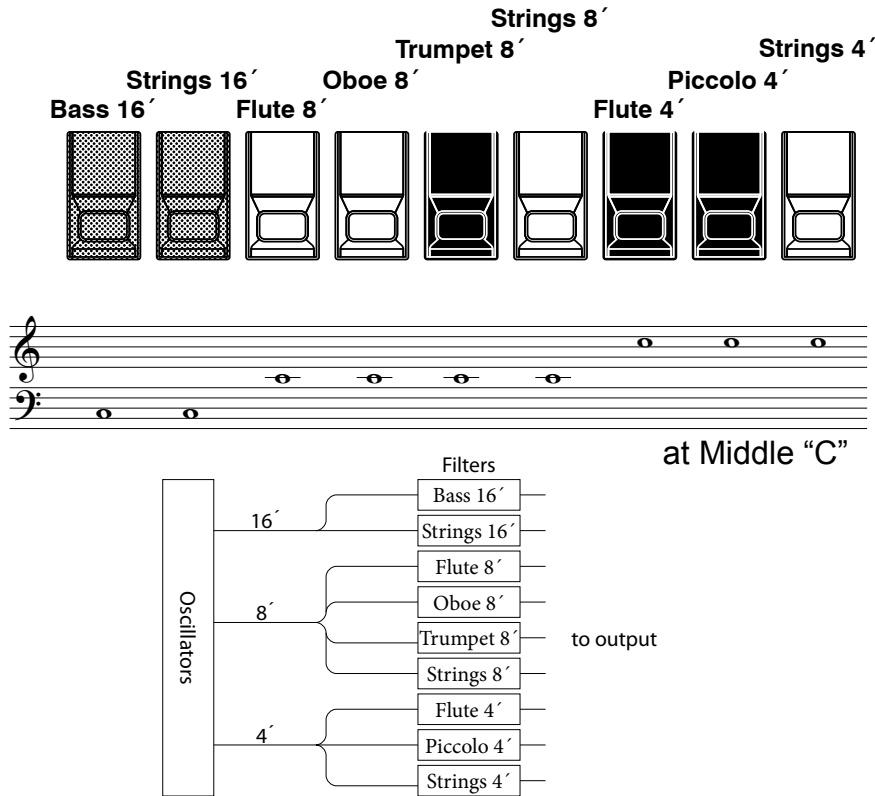

The original Italian “Farf” type organ was tablet-equipped with different sounds at various footages. On the SKX, the operation is made with Drawbars instead of tablets.

At the same footage, the tablets gives grow brighter in sound as you progress to the right. The names “Flute”, “Strings”, etc. are general descriptions and do not reflect the tonalities or characteristics of the real instruments.

tips TABLET

The “tablet” means a rocker-type tilt tablets of the vintage organs.



Bass 16'	Strings 16'	Flute 8'	Oboe 8'	Trumpet 8'	Strings 8'	Flute 4'	Piccolo 4'	Strings 4'	Farf
16'	8'	4'	2'	II	III	IV	~	^	Vx.
Bourdon	OpenDiap	Gedeckt	VoixCist	Octave	FluteDolce	Flute	Mixture	Hautbois	Pipe
16'	8'	8'	II	4'	4'	2'	III	8'	

When using the Farf Organ Type, refer to the “Farf” row on the other side of the Drawbars for the correspondence between each bar and the footage.

DRAWBARS (PIPE)

UPPER:	Bourdon 16'	Open Diapason 8'	Gedeckt 8'	Viole Celeste II	Octave 4'	Flauto Dolce 4'	Flute 2'	Mixture III	Hautbois 8'
LOWER:	Principal 16'	Principal 8'	Melodia 8'	Rohr Flute 8'	Prestant 4'	Flute 4'	Super Octave 2'	Mixture IV	Trom- pette 8'
PEDAL:	Sub Bass 16' + Gedeckt 8'		Principal Chorus + Mixture IV						

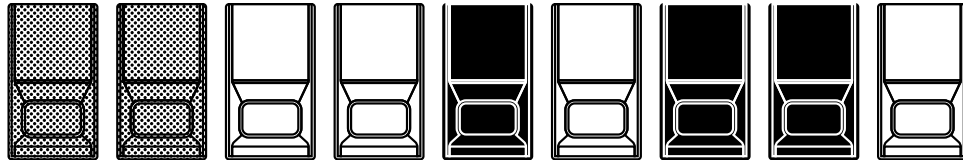

When using the Pipe Organ Type, the stops are registered through the Drawbars, and follow the classic organ layout left to right as follows: Flue, Mixture and Reed.

On the UPPER and LOWER parts, each Drawbar corresponds with a stop of the pipe organ.

On the PEDAL part, two stops sound with one Drawbar.

NOTE: When "Pipe" type is activated, the Drawbars will function similar to drawstops on a traditional pipe organ - pulling a Drawbar "out" will turn the associated Pipe Voice "ON" while pushing the Drawbar "in" will turn the Pipe Voice "OFF." The Pipe Voices do not have gradations of volume - they are either "ON" or "OFF."

NOTE: The effects - Vibrato & Chorus, Leslie, Overdrive - are not available on the Pipe type voices.

tips STOP

A single voice or sound on a pipe organ is referred to as a "Stop" due to the fact that air flow is "stopped" (or started) by manipulating the individual knobs or tablets which turn sounds "ON" or "OFF".

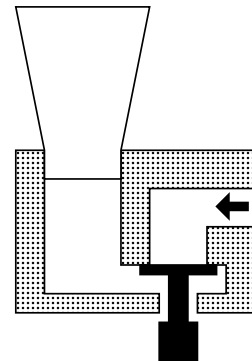

Bass 16'	Strings 16'	Flute 8'	Oboe 8'	Trumpet 8'	Strings 8'	Flute 4'	Piccolo 4'	Strings 4'	Fort.
16'	8'	4'	2'	II	III	IV	~	^	Vx.
Bourdon	OpenDiap	Gedeckt	VoixClist	Octave	FluteDolce	Flute	Mixture	Hautbois	Pipe
16'	8'	8'	II	4'	4'	2'	III	8'	

If the Organ Type is Pipe, refer to the "Pipe" row on the other side of the Drawbars for the correspondence between each bar and the footage.

ON / OFF AND VOLUME CONTROL

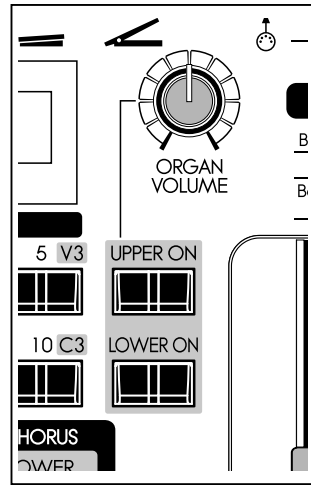

The UPPER and LOWER part of the Organ section can be sounding “ON” or “OFF” by using [UPPER ON] and [LOWER ON] buttons.

tips PEDAL PART IS ALWAYS ON

The PEDAL part has no switch and always “ON”. Because the Extra Voice Section has no PEDAL part, and it does not necessary to mute.

NOTE: You can set that the Extra Voice Section turns “OFF” automatically by the Organ Section is switched “ON”. (P. 79)

To adjust volume of the entire Organ section, use [ORGAN VOLUME] knob.

MATCH THE REGISTRATION TO DRAWBARS

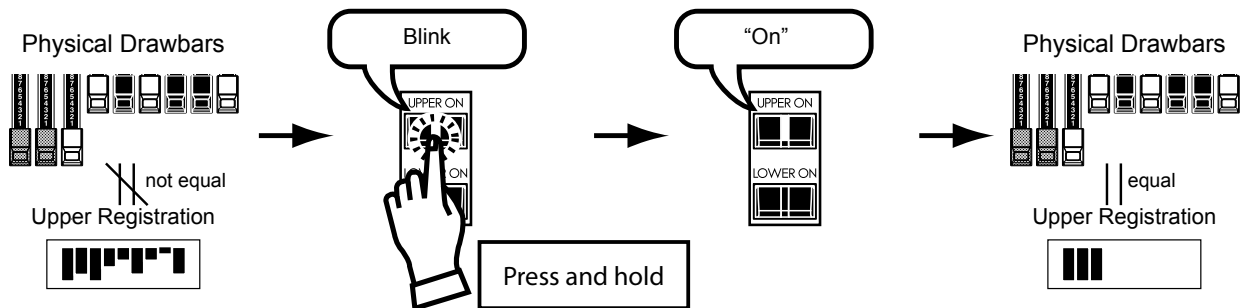

When you recall a Patch, the Drawbar registration of the recorded Patch is heard, instead of the physical Drawbar setting. If you move any Drawbar, its position takes precedence over the recorded registration, although the Patch is not changed.

If you want to switch to the physical Drawbar setting immediately, Press and hold either the [UPPER ON] or the [LOWER ON] button in the Organ section until the light blinks then release it. The physical registration now becomes “current” for the selected part.

NOTE: This function does not update the PEDAL registration.

NOTE: You can temporarily substitute the UPPER Drawbar registration with Upper or Lower Drawbar settings instead of the Patch content (P. 78).

PERCUSSION

Organ tones are normally heard as long as the playing key is held down. The word “Percussion” refers to a tone that is not steady and fades away, such as a piano or chimes. The SKX has Percussion tones which enhance the sounds produced by the Drawbars.

“Touch-Response Percussion” is very useful for highlighting single notes, full chords, even entire songs.

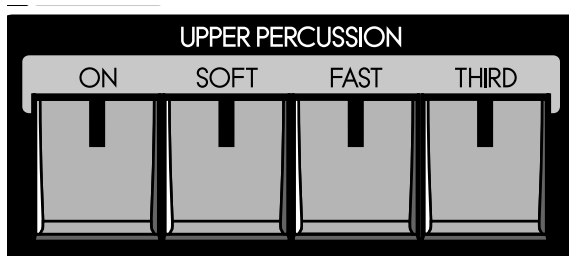

[ON] button

Switches the Percussion “ON”(LED lit) and “OFF”.

[SOFT] button

This reduces the volume of the Percussion tone.

When the LED is OFF, it is “NORMAL”. If you press the [SOFT] button (LED is lit on), the Percussion volume is “SOFT”.

[FAST] button

When this button is OFF (LED not lit) the Percussion tone will decay slowly like a bell. When it is “ON” (LED is lit) the Percussion tone will decay rapidly like a xylophone.

[THIRD] button

Switches the Percussion harmonic.

When this button is OFF, the second harmonic speaks at the same pitch as the 4’ Drawbar.

The third harmonic tone speaks at the same pitch as the 2 2/3’ Drawbar. To select, press the [THIRD] button (light on).

NOTE: Percussion is available on 3 Organ Types; BType1, BType2 and Mellow.

NOTE: You can fine-tune the parameters of the Percussion (P. 80).

tips DECAY

On the piano, the sound gradually fades out even if you keep touching the key. It is called Decay. The violin sound, on the contrary, keeps sounding at a certain volume. It is called Sustain.

1’ DRAWBAR CANCEL

As on the Vintage Hammond B-3/C-3, the 1’ Tone Wheel Drawbar is inoperative when the Percussion is engaged.

NOTE: If you wish the 1’ Drawbar to remain operative, you can change the parameter. (P. 80)

The Hammond Vibrato & Chorus is another hallmark of the Classic Hammond sound. Vibrato alters the pitch slightly, as a violinist, singer, or guitarist may do. And Chorus combines a detuned signal with the original for a lush tone.

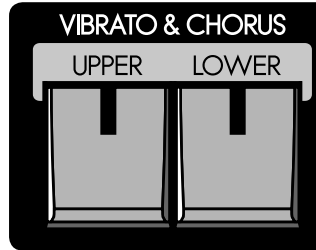

[UPPER] button

Pressing [UPPER] button “ON” (red LED lit) will turn the Vibrato & Chorus effect on for the UPPER Drawbars.

[LOWER] button

Pressing [UPPER] button “ON” (red LED lit) will turn the Vibrato & Chorus effect on for the LOWER and PEDAL Drawbars.

NOTE: Vibrato & Chorus is available on 5 Organ Types; BType1, BType2, Mellow, Vx and Farf.

NOTE: The mode, speed etc. of the Vibrato & Chorus effects can be fine-tuned. (P. 81)

tips VIBRATO AND CHORUS OF HAMMOND ORGANS

On string instruments, the vibrato effect is created by changing the string tension by one’s fingers. On wind instruments, by changing the strength of breath. On electronic instruments with analog circuitry, by modulating the oscillator. As the rotation of the Tone Wheels of the original B-3/C-3 was stabilized by the synchronous motor, it was not possible to provide a vibrato effect. On these models, the vibrato effect was obtained by modulating the signal post-generator.

The vibrato & chorus system of the original B-3/C-3 consisted of a 9 stage delay line using LC phase shift circuits. This produced a very short delay of about 1 ms. Tones were passed through coils, delaying the phase. Several coils were connected in tandem and when the output of each tap was passed from the top to the last by turns, the pitches gradually lowered. By taking the output of each tap from the last to the top by turns on the contrary, the pitch would gradually rise. These operations were automatically made by turning the scanner with a motor.

The scanner was used to select one of multiple input terminals by the static connection. As each terminal was selected by the “blades” which approached each other, a popping noise like that of a switch did not occur and the signals of neighboring terminals cross-faded and switched themselves.

The mode-selection of vibrato effects was made by changing the range of the connecting tap.

As this system modulated the produced tonal signals and not the oscillator, the original sound could be heard without the vibrato effect. By mixing the sound with the vibrato effect and the original sound, the chorus effect was obtained.

On this model, the chorus and vibrato effects are simulated and modelled in the original fashion digitally, by the DSP, without using moving parts.

TO SELECT THE VIBRATO & CHORUS MODE

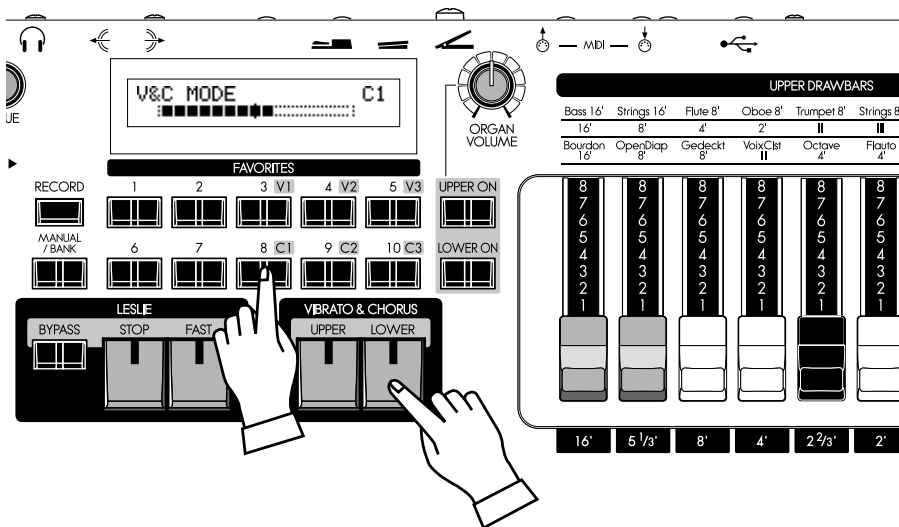

To select the Vibrato & Chorus Mode instantly, press and hold either the VIBRATO & CHORUS [UPPER] or [LOWER] button, and press any of the six buttons shown above ([V1] to [C3]) to select the Vibrato or Chorus Mode you want.

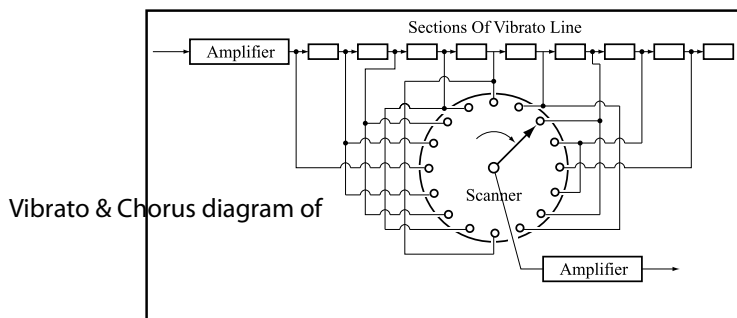

Vibrato & Chorus diagram of

OVERDRIVE

Overdrive simulates the effect of pushing an amplifier beyond its normal limits to achieve a more aggressive sound.

By changing the drive amount, various sounds are obtained from an unclipped warmth to a hard distortion.

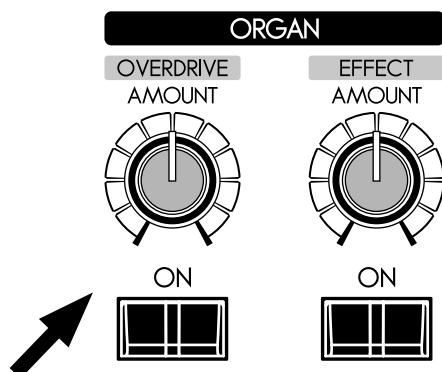

[OVERDRIVE ON] button

Turns the Overdrive effect “ON” (LED lit) or “OFF” (LED not lit) for the Organ section.

[OVERDRIVE AMOUNT] knob

Adjusts the amount of the Overdrive effect.

Rotating the knob clockwise increases the depth of the effect.

NOTE: Overdrive for Organ section is available on 5 Organ Types; BType1, BType2, Mellow, Vx and Farf.

NOTE: You can fine-tune the Overdrive sound. (P. 90)

NOTE: The button and knob are for the Organ section. The Overdrive effect for the Extra Voice section is operated by the parameter in the control panel. (P. 97)

The rotating sound of the LESLIE Speaker is the natural partner of the Hammond Organ. A Digital version is built-in to the SKX; and the controls will also function with a connected physical Leslie.

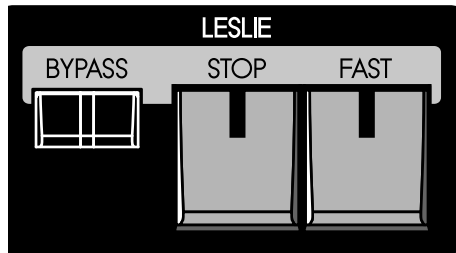

[FAST] button

Toggles the mode of the Rotor by two steps. Every press switches the status. When the LED is lit, the mode is “FAST”, and when it is not lit, it is “SLOW” or “STOP”.

[STOP] button

To toggle the “FAST” and “SLOW” when you pressed the [FAST] button, turn this button “OFF” (LED not lit).

To toggle the “FAST” and “STOP” when you pressed the [FAST] button, turn this button “ON” (LED lit).

[BYPASS] button

When the LED for this button is “OFF”, the Organ section sound is output from the rotary channel (Leslie effect).

To bypass the Leslie effect, press this button and the light will go ON. Regardless of the status of the [FAST], [STOP] buttons, the Organ section sound is output from the stationary channel.

NOTE: Leslie Effect is available on Organ section except Pipe type.

NOTE: You can fine-tune the parameters of the Leslie effect. (P. 82)

tips STATUS CHART OF EACH BUTTON

BUTTON			MODE	
BYPASS	STOP	FAST	CH=1	CH=3, on-board Leslie effect
Off	Off	On		Fast
Off	Off	Off		Slow
Off	On	On		Fast
Off	On	Off		Stop
On	On	On	Fast	Bypass
On	On	Off	Stop	
On	Off	On	Fast	
On	Off	Off	Slow	

Diagram of 3 channel Leslie Speaker

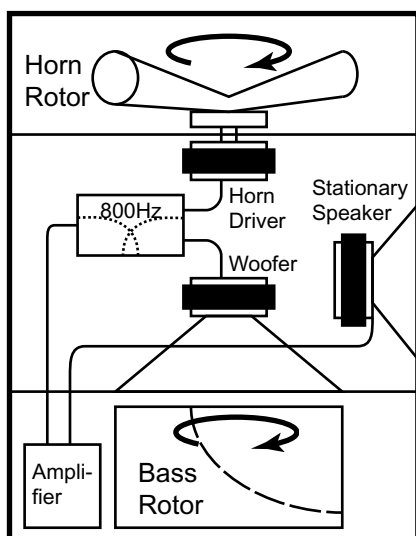

tips WHAT IS THE LESLIE EFFECT?

The Leslie Speaker was invented by Donald Leslie in 1941 to make the Hammond Organ sound like a Theatre Pipe Organ. Using motor-driven rotating horns and baffles, Leslie’s invention gave the organ a rich and moving tone, which quickly became it’s own unforgettable sound.

In its basic form, the Leslie Speaker has an built-in amplifier and two Rotors; the “Horn Rotor” for treble and the “Bass Rotor” for bass which are each fed by a custom-designed driver/speaker. The combination of the two utilizes the “Doppler Effect” to give the unique Leslie “swirling” sound..

Some models have not only Rotors but also a fixed speaker. The circuit for sending the sound to the Rotor is called the “Rotary Channel”, and that for the fixed speaker is called the “Stationary Channel”.

The Digital Leslie on-board the SKX employs all the proprietary concepts used in the physical speakers, but realizes them in the digital realm. It is recommended that you run the Main Outputs “in stereo” to get the fullest effect.

MULTI-EFFECTS, REVERB

The SKX has on-board Digital Multi-Effects and Reverb to enhance the Organ section.

◆ MULTI-EFFECTS

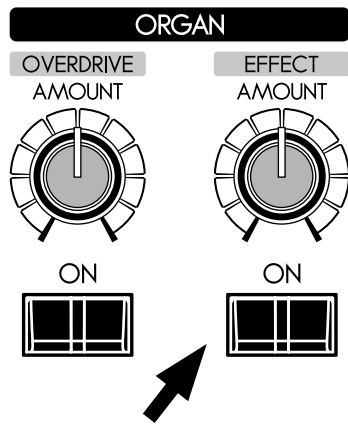

[EFFECT ON] button

To engage the Multi-Effects. Press this button and the light will go ON.

[EFFECT AMOUNT] knob

Adjusts the amount of the Multi-Effects.

NOTE: There are numerous parameters in the Multi-Effects. The detailed settings of the parameters are adjusted on the control panel. (P. 91)

◆ REVERB

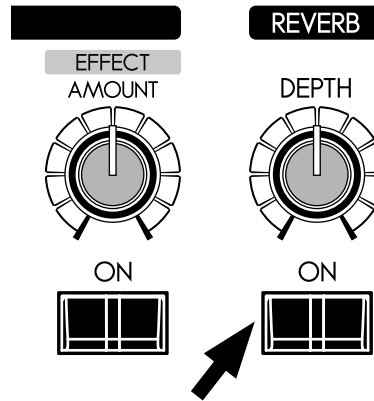

The Digital Reverb is common to both Organ and Extra Voice sections.

[REVERB ON] button

To engage the Reverb, press this button and the light will go ON.

[REVERB DEPTH] knob

Adjusts the depth of the Reverb.

NOTE: You can fine-tune the time etc. of the Reverb. (P.99)

A popular option for playing the Pedals or Manual Bass is Pedal Sustain, which allows the Pedal voice to smoothly decay upon release, much in the manner of a string bass. Using the Lower keyboard, you can play the Pedal part together (Manual Bass). The Pedal part can be played by Lower keyboard, or the Lower part can be played by the extended Pedalboard (Lower To Pedal).

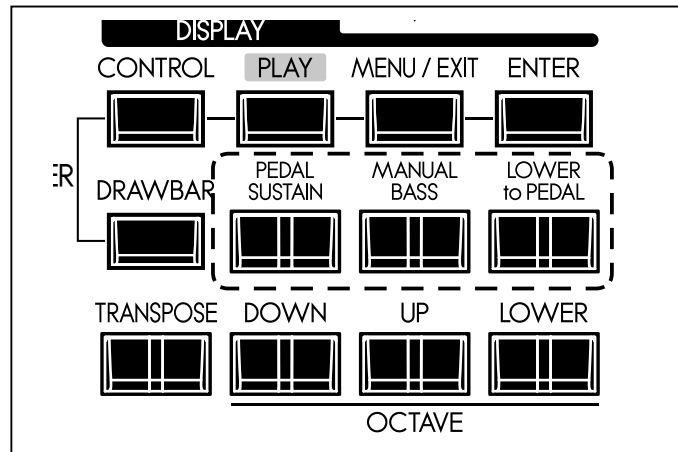

[PEDAL SUSTAIN] button

Touching this button will turn Pedal Sustain “ON” (LED lit) and “OFF” (LED not lit).

After releasing your foot from the Pedalboard (or pressing and releasing a bass note on the Lower keyboard when using Manual Bass, the sound will slowly fade, or decay.

NOTE: You can control the decay time of the Pedal Sustain (P. 73).

[MANUAL BASS] button

Touching this button will turn Manual Bass “ON” (LED lit) and “OFF” (LED not lit).

If you played the Lower keyboard, the Pedal part will sounds together.

The default range of the Manual Bass is up to the middle “B”.

NOTE: You can change the upper note limit of the Manual Bass (P. 110).

NOTE: You can set the Manual Bass either to play the lowest note if multiple notes are played or, if a chord is played on the Lower keyboard, to sound the root note of the chord (P. 110).

[LOWER to PEDAL] button

This feature allows a connected MIDI Pedalboard to play the sounds registered for the LOWER part in addition to whatever PEDAL registration may be selected.

Touching this button will turn Lower to Pedal “ON” (LED lit) and “OFF” (LED not lit).

NOTE: You can change the upper limit playing range of Lower to Pedal (P. 110).

tips COUPLER

In the organ terminology, a “Coupler” is a device which allows sounds from one part to be played on another. Examples are Lower to Pedal and Manual Bass.

OCTAVE SHIFT

The keyboard can be shifted up or down in one-octave units to facilitate easier play.

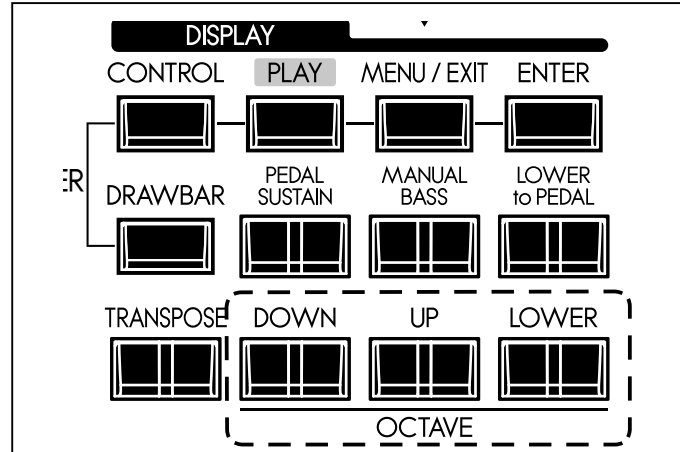

[OCTAVE] buttons

Raises or Lowers each part by one-octave units within a range of ± 2 octaves.

- ♦ To raise the octave of the UPPER keyboard, press the [UP] button.
- ♦ To lower the octave of the UPPER keyboard, press the [DOWN] button.
- ♦ To raise the octave of the LOWER keyboard, press and hold the [LOWER] button and press the [UP] button.
- ♦ To lower the octave of the LOWER keyboard, press and hold the [LOWER] button and press the [DOWN] button.



Octave of LOWER is at "+1".

When changing octaves here, the status of the Octave is briefly shown on the display.

NOTE: OCTAVE buttons can be assigned various functions instead of the octave shift (P. 78).

NOTE: You can select whether the Octave setting changes while notes are being held or when the next note is pressed after releasing the notes being held (P. 79).

The Transpose function allows you to match the same key of other instruments or vocalists without changing the key that you are playing in. For example, if you set Transpose at [+5], the note “F” sounds when you play the “C” key. (By playing in the key of C the SKX sounds in the key of F.)

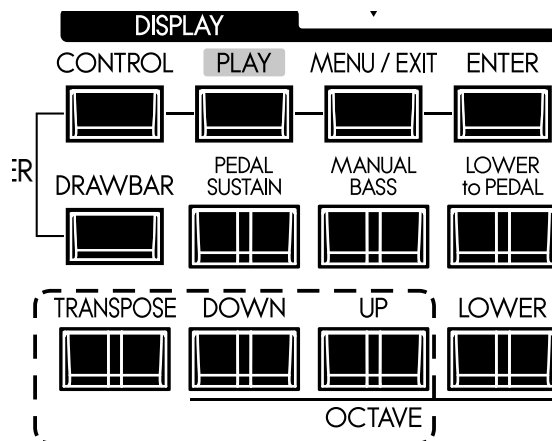

[TRANSCOPE] button

- ◆ To raise the pitch by semitone, press the [UP] button, while holding down the [TRANSCOPE] button.
- ◆ To lower the pitch by semitone, press the [DOWN] button, while holding down the [TRANSCOPE] button.

You can set Transpose in the range from -6 to +6 semitone.

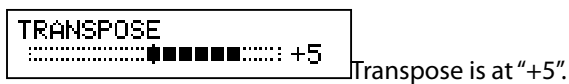

When performing this operation, the status of the transposition is shown in the display.

Transpose is mapped to the following points:

- Between the internal keyboards and the built-in sound engines.
- Between the MIDI IN and the built-in sound engines.
- To the External Zone.
- When the MIDI Pedalboard XPK-100 is connected, Transpose value will synchronize with it.

NOTE: The Transpose is a temporary parameter, and is not recorded to any Patch. When the power is switched OFF, it returns to 0.

NOTE: You can select whether Transpose changes while notes are being held or when the next note is pressed after releasing the notes being held (P. 79).

EXTRA VOICE SECTION

The EXTRA VOICE section contains the sounds other than Organ which comprise the SKX. As a system, you select which voice to allocate to what part.

There are two sections of the Extra Voice on the SKX. The Organ and Extra Voice sections can be played simultaneously.

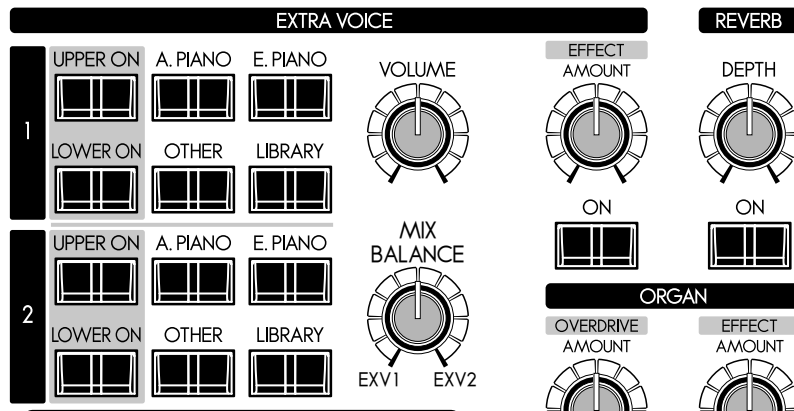

ALLOCATE

To play the Extra Voices, you must allocate them to either the UPPER or LOWER parts. The Extra Voices can play alongside the Organ.

[UPPER ON], [LOWER ON] buttons

Selects either the UPPER/LOWER part to allocate Extra Voices. To play the Extra Voices, press either button and (LED ON).

To CANCEL the Extra Voice allocation, press the desired button again (LED OFF).

NOTE: You can set that the Organ section turns "OFF" when an Extra Voice section is switched "ON". (P. 79)

BUILT IN SOUNDS AND LIBRARY

There are 4 groups of resident sounds, corresponding to the Voice Groups. These core sounds may not be overwritten. You may expand this core with Voice Libraries which can be download from the Hammond website.

To select instruments, see "SELECT INSTRUMENTS" on (P. 30), and the "INSTRUMENT LIST" (P. 136) for the built-in sounds.

tips EXTRA VOICE

The Extra Voice section on your SKX is not related to, and does not replicate the sounds of F-100 "Extravoice" (1960's).

tips PROCHORD™ FEATURE

Some of the Extra Voice instruments contain the ProChord™ feature. These will have "Pcd" as a suffix added to their names.

If you allocate this instrument to the Upper part, play a chord on the Lower keyboard and play a single note on the Upper keyboard, you will hear harmony added to the single-note melody.

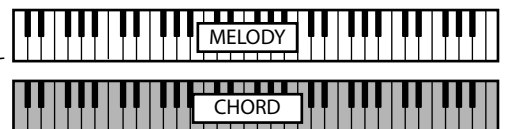

ProChord is a unique feature which allows you to play professional right-hand harmony while playing a single-note melody. The harmonization applied to the melody is determined by the chord played by the left hand.

When notes or chords are played on a Lower keyboard and a note is played on an Upper keyboard, the note represented by the key played on the Upper keyboard is heard along with a scored harmony pattern which sounds according to the Chord Root and Chord Type selected by the notes played on the Lower keyboard. The Chord Root is the letter name of the chord (F, A, B=, etc) while the Chord Type is the denomination of the chord (Major, Minor, etc.)

The SKX is equipped with Multi-Effects capable of adding various effects to the Extra Voices, and Reverb capable of adding the effects of playing in a concert hall.

◆ MULTI-EFFECTS

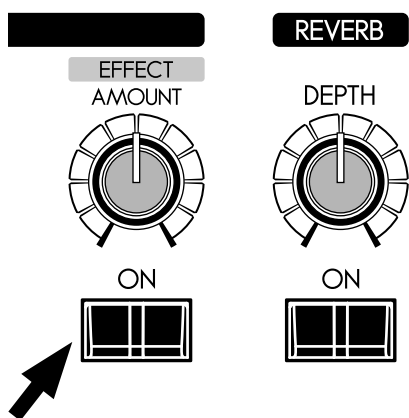

[EFFECT ON] button

To engage the Multi-Effects, press this button and the light will go ON.

[EFFECT AMOUNT] knob

Adjusts the amount of the Multi-Effects.

NOTE: There are numerous parameters in the Multi-Effects. Detailed settings are made with the parameters in the control panel. (P. 97)

◆ REVERB

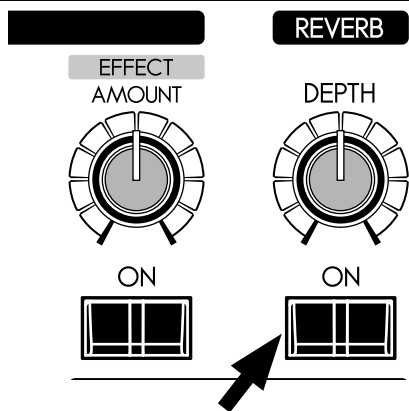

Reverb is common for both the Organ and the Extra Voice sections.

[REVERB ON] button

To engage the Reverb, press this button and the light will go ON.

[REVERB DEPTH] knob

Adjusts the depth of the Reverb.

NOTE: You can fine-tune the time etc. of the Reverb effect. (P. 99)

◆ TWO EXTRA VOICES AND MULTI-EFFECTS

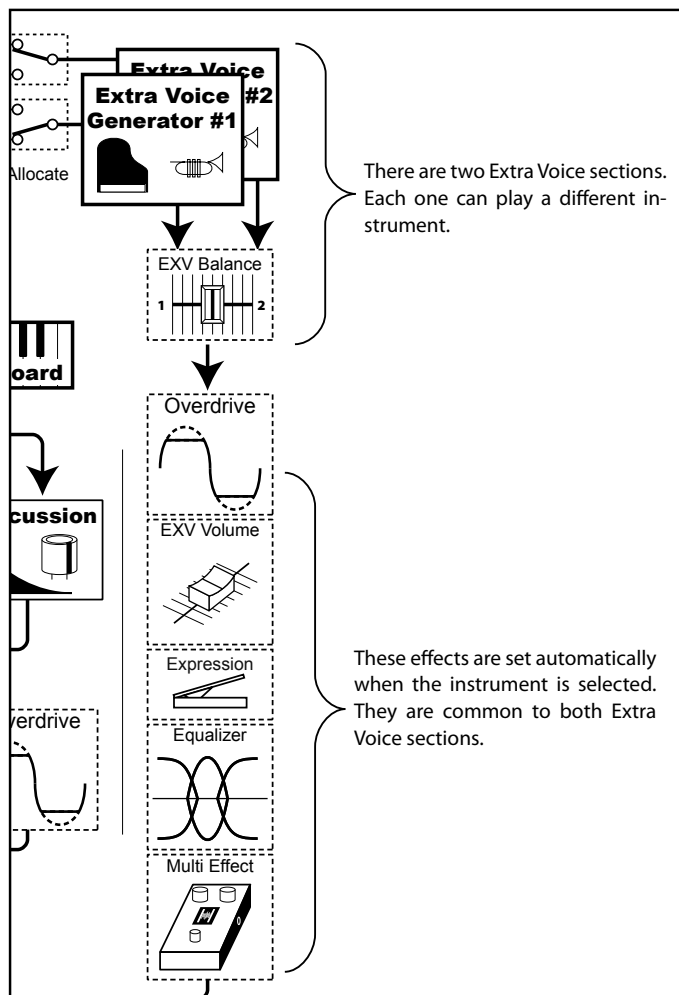

There are two Extra Voice sections. Each one can play a different instrument.

These effects are set automatically when the instrument is selected. They are common to both Extra Voice sections.

There are two Extra Voice sections as shown as above, but the effects following are only one section such as Overdrive, Equalizer, and Multi-Effects.

The effects are automatically set when the instrument on the Extra Voice. If the Extra Voice 1 and 2 are used simultaneously, the effects are set by instrument which selected at last.

The settings you have prepared can be recorded to User Patches.

“USER” AND “PRESET”

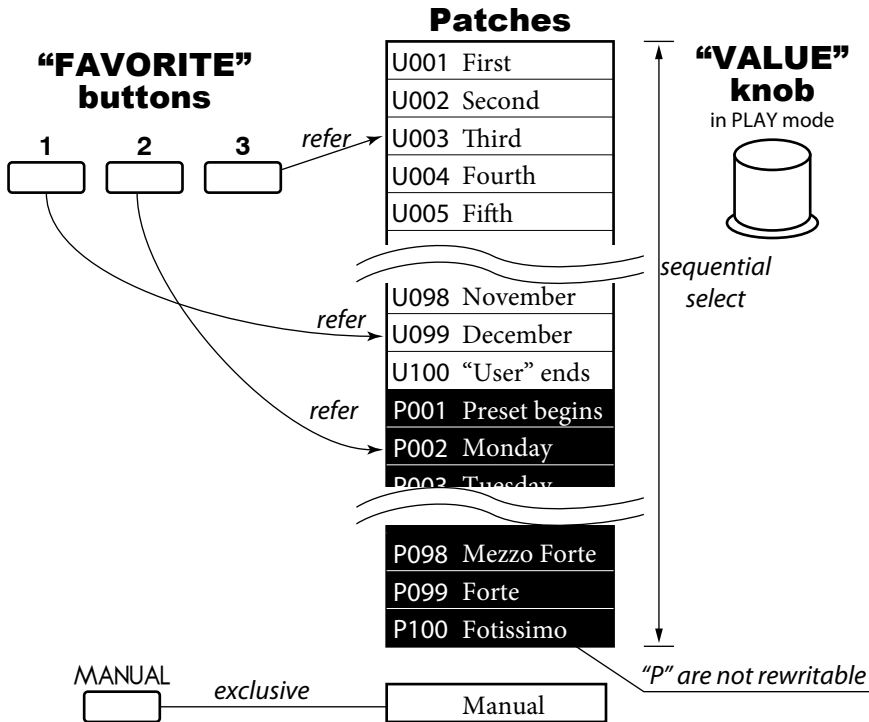

There are 100 USER and 100 PRESET Patches as illustrated. The “User” Patch are over-write capable. The “Preset” Patches are not.

To call the Patch, select the Patch Number with the [VALUE] knob in the Play mode (P. 23).

To record the present setting to the Patch, first give a name to it and designate the Patch number before recording the Patch (next page).

The [MANUAL] button on the left side of the top panel shifts the focus to all the current settings of the top panel, and the current internal settings. It is used as a starting point for writing your own Patches, or for the musician who prefers to register “by hand” instead of using Patches.

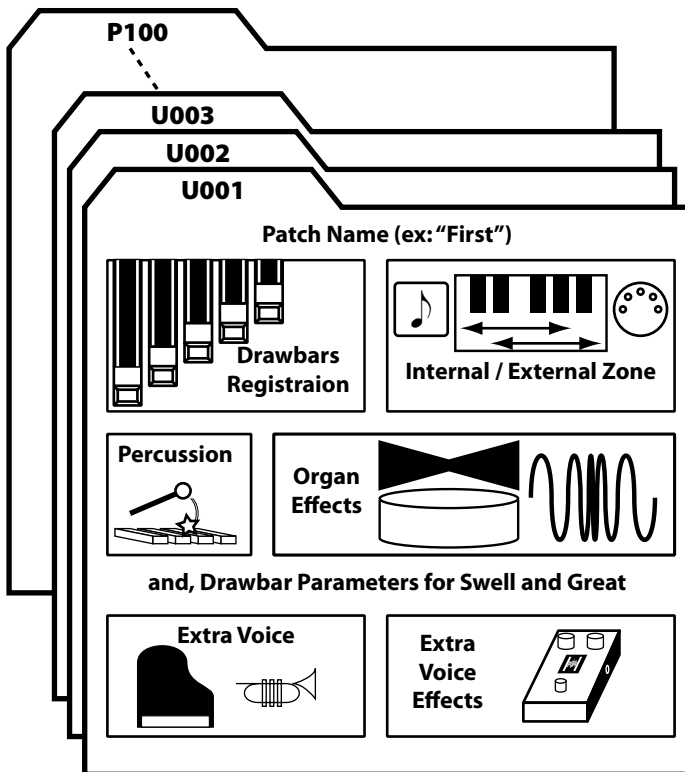

tips PATCH LOAD

Only the Drawbar registrations of each keyboard were recorded to the preset of the B-3/C-3. But many more parameters than the Drawbar registrations are recorded to the Patches on the SKX.

If you wish to keep the “traditional” style of registration (Drawbars only), Select the proper parameters in “Patch Load”. (P. 74)

NAME THE PATCH

1 GO TO THE MENU MODE

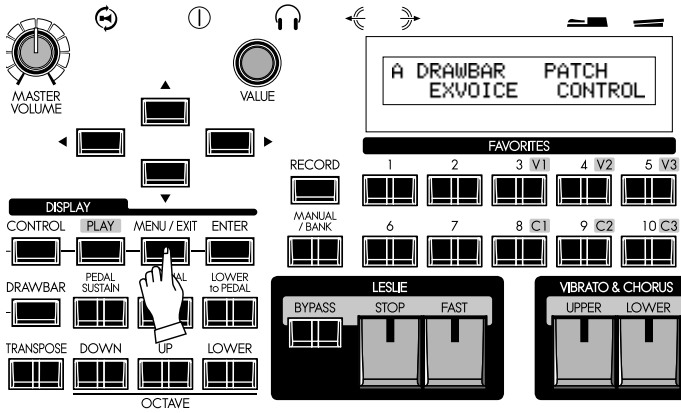

Press the [MENU/EXIT] button.
Menu mode will be displayed.

2 GO TO PAGE A

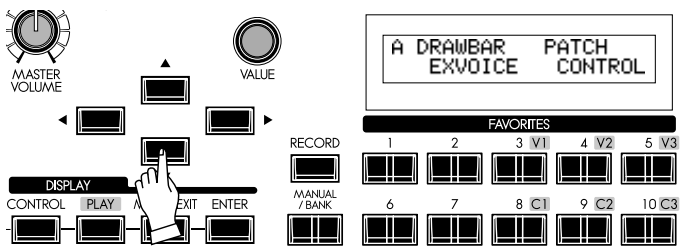

If Page A is not displayed, go to Page A by pressing [▼] button.

3 SELECT THE "PATCH"

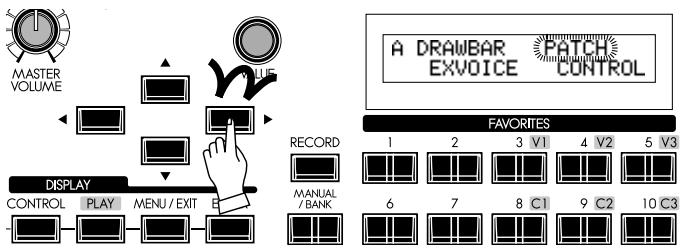

Press [▶] button twice and move the cursor to "PATCH".

4 GO TO PATCH FUNCTION MODE

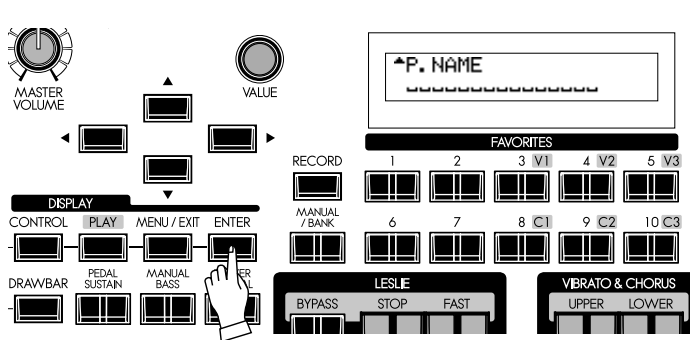

Press [ENTER] and go to PATCH Function mode.

5 INPUT NAME

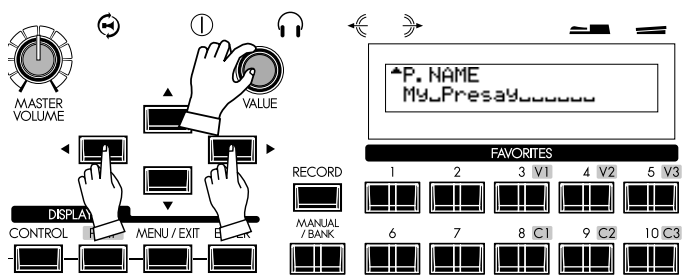

You can enter a name using up to 15 letters.

- [◀],[▶] buttons: Moves the cursor.
- [VALUE] knob: Selects letters.

The available characters include: Punctuation Marks (space - , ' &), Numeric Characters (0 - 9), Upper-case Letters ("A - Z"), and Lower-case Letters ("a - z").

You must save the Patch in order for the Patch Name to be remembered (as explained on the next page).

RECORD TO THE PATCH

Example: RECORD TO "U032"

1 ENTER THE NAME



Enter the name of the Patch. (P. 59)

2 PRESS THE [RECORD] BUTTON

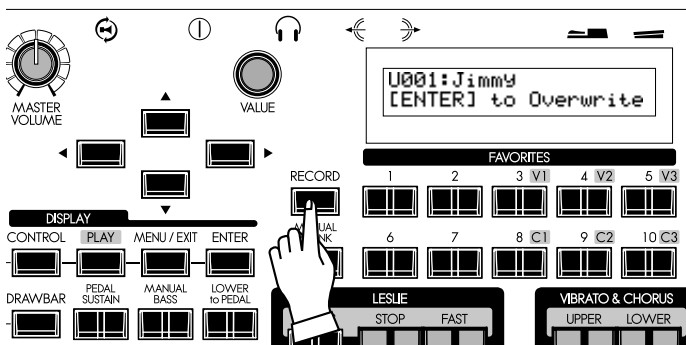

Press the [RECORD] button. A prompt will appear in the display allowing you to select the Patch you want to record.

3 SELECT THE PATCH NUMBER

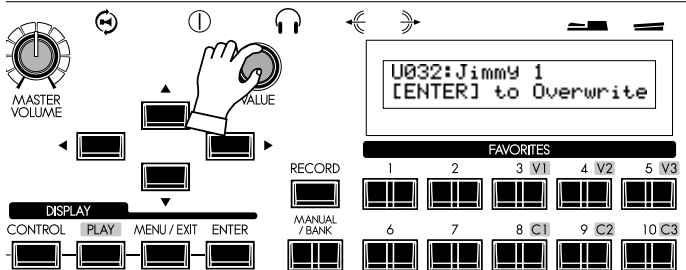

Select the Patch number you wish to record with the [VALUE] knob (This time select U032) or type the buttons such as [3] [2].

4 PRESS [ENTER]

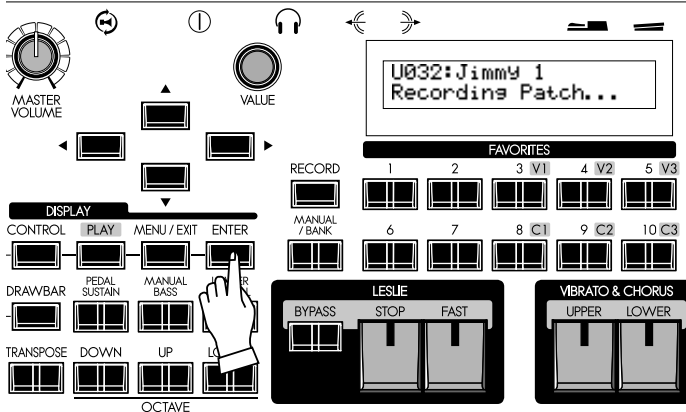

Press the [ENTER] button. The Patch is confirmed and the display will show the following for approximately 1/2 second: Recording Patch...

When the recording is completed, the display returns to the previous one.

NOTE: The recorded Patch data is retained if the power is switched off or disconnected.





**USING THE
CONTROL PANEL**

62 WHAT YOU CAN DO ON THE CONTROL PANEL

Your access to deep-editing the SKX. All of the parameters and all of the controls not covered by the top panel knobs and switches are here.

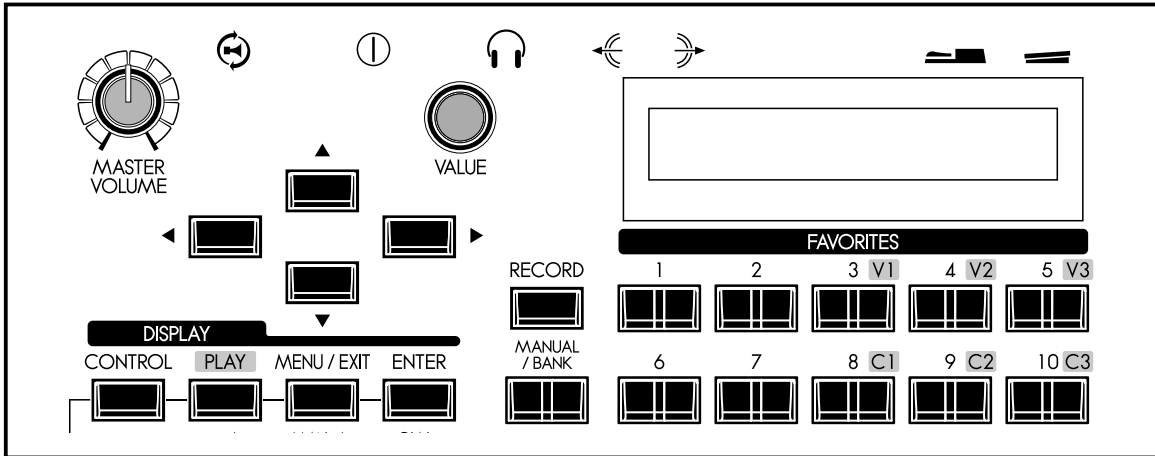

The modes displayed are, basically “PLAY”, “MENU” and “FUNCTION”. See how to read them and how to use the buttons on the next pages.

PLAY mode ■■■ ■ 88 ■■■■ ■
U064 Or:Born To Be W

MENU mode A DRAWBAR PATCH
EXVOICE CONTROL

FUNCTION mode ♣BASS SLOW FAST LEV
SPD 36 393 0▶

MENU MODE

The Menu mode provides a directory of all the various functions.

To locate this mode:

Press the [MENU/EXIT] button.

Use the [▲] and [▼] buttons to access the different Pages of the Menu mode.

There are 6 pages in the Menu mode, labeled “A” through “F.” Each page has up to four items.

Notice that one of the Menu items is flashing. Use the [◀] and [▶] buttons, or turn the [VALUE] Rotary Knob to select the item you wish to edit.

When the item you want is flashing, touch the [ENTER] button. The Function mode for the selected item will display.

HOW TO READ THE DISPLAY

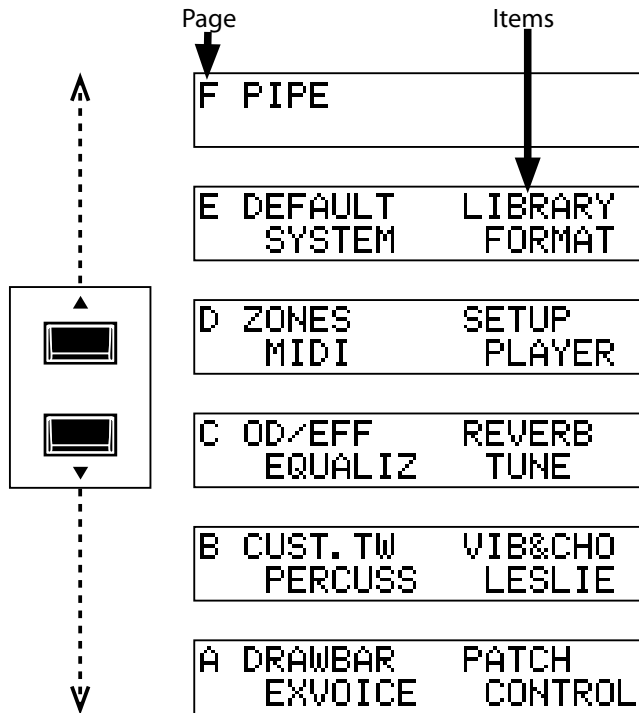

OPERATION IN THIS MODE

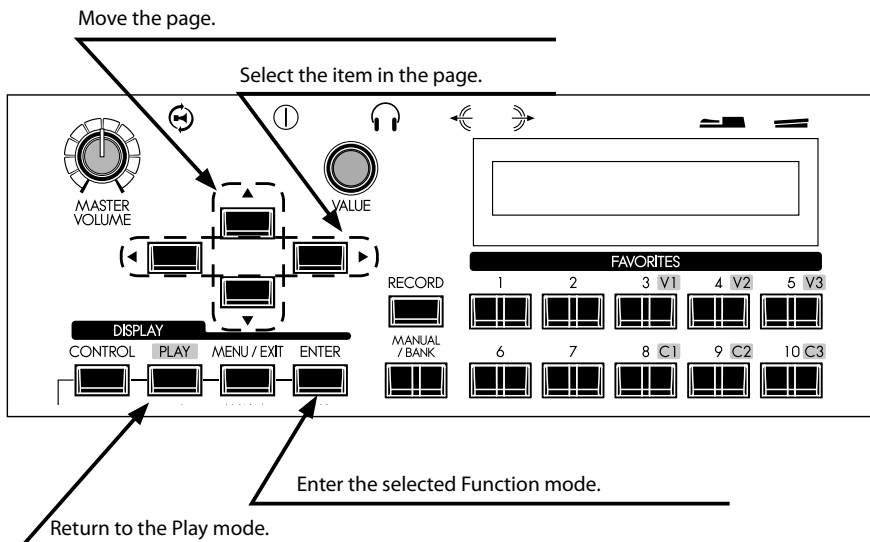

MENU AND THE CONTENTS

PAGE A

1. DRAWBAR

Allows you to modify the characteristics of the Organ section (sounds produced by the Drawbars.) (P. 72)

2. EXVOICE

Allows you to modify the characteristics (Volume, Note Range, Velocity, etc.) of the Extra Voices. (P. 75)

3. PATCH

Allows you to name a Patch, select which parameters will load and set assignment of Favorites. (P. 74)

4. CONTROL

Allows you to change how the various controls, such as Foot Switch, Expression Pedal, etc., will function. (P. 76)

PAGE B

1. CUST.TW

Allows you to customize the Tone Wheel settings of the Lower and Upper part for Organ section. (P. 85)

2. PERCUSS

Allows you to adjust the characteristics (Volume, Decay time, Key Tracking, etc.) of the Percussion voices of the Organ section. (P. 80)

3. VIB & CHO

Allows you to adjust the characteristics of the Vibrato & Chorus. (P. 81)

4. LESLIE

Allows you to adjust the characteristics of the built-in Leslie effect and to adjust external Leslie speaker settings. (P. 82)

PAGE C

1. O.D./EFF

Allows you to adjust the characteristics of the Overdrive and the Multi-Effects here. (P. 90)

2. EQUALIZ

Allows you to adjust the Patch Equalizer and Master Equalizer. (P. 98)

3. REVERB

Allows you to adjust the Reverb parameters. (P. 99)

4. TUNE

Allows you to set the tuning of the entire keyboard. (P. 100)

PAGE D

1. ZONE

Allows you to control the Internal and External Zone. (P. 110)

2. MIDI

For setting the basic MIDI operations. (P. 112)

3. SETUP

Allows you to Save or Load a Setup to or from the USB Flash Drive. (P. 116)

4. PLAYER

Allows you to control the Music Player. (P. 127)

PAGE E

1. DEFAULT

Allows you to reset the SKX to various factory default settings. (P. 101)

2. SYSTEM

Allows you to customize the System Parameter and display the System information. (P. 102)

3. LIBRARY

Allows you to control Voice Library of the Extra Voices. (P. 131)

4. FORMAT

Allows you to format a USB Flash Drive for use with the SKX. (P. 117)

PAGE F

1. PIPE

Allows you to adjust the characteristics of the Pipe voices of the Organ section. (P. 88)

FUNCTION MODE

These modes are for selecting and controlling the function.
All modes can be navigated the same way.

HOW TO READ THE DISPLAY

There is another page above (or below) this page.

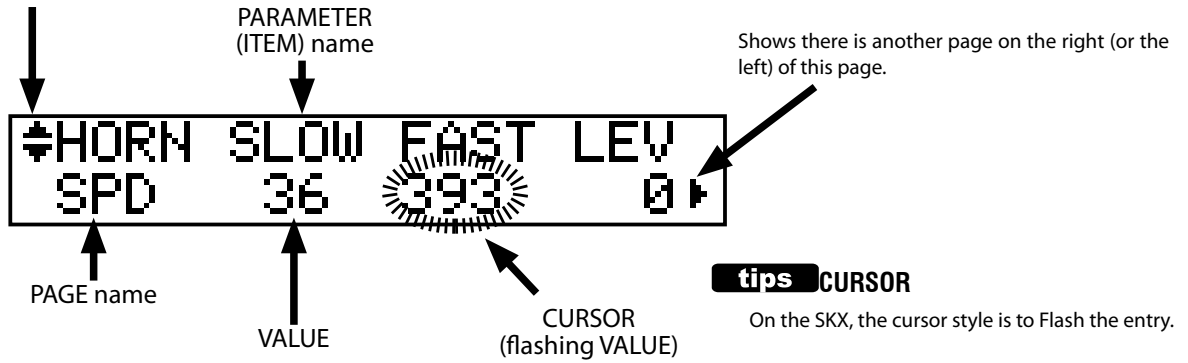

BUTTON OPERATION IN THIS MODE

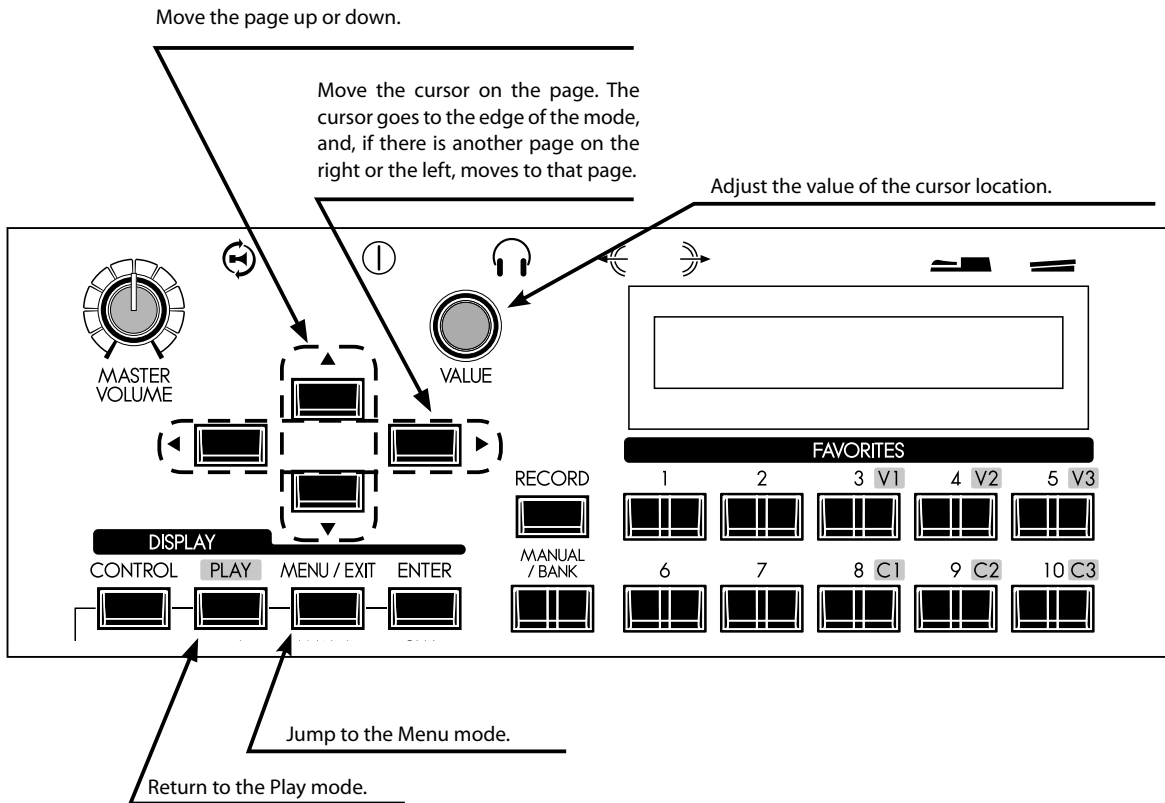

PARAMETER OPERATION EXAMPLE:

ADJUST THE [FAST] PERCUSSION DECAY TIME

1 LOCATE THE MENU MODE

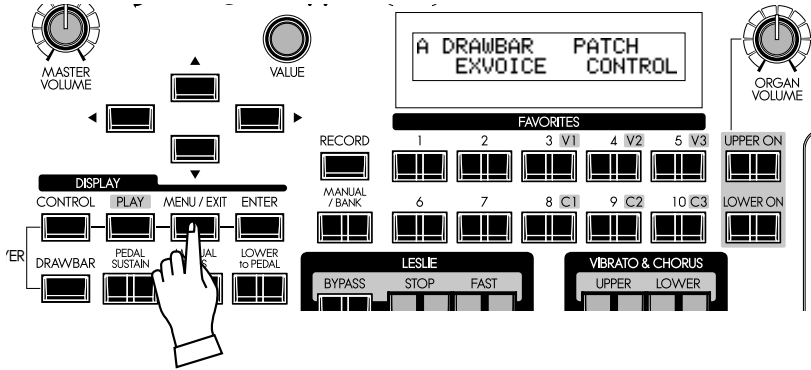

Press the [MENU/EXIT] button.
The Menu mode is displayed.

2 SELECT THE MENU PAGE

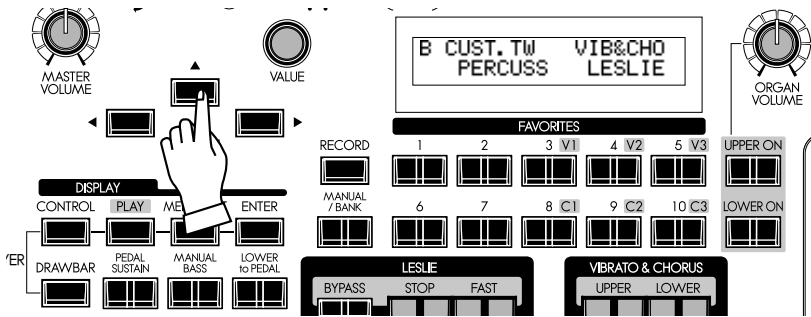

Locate the “PERCUSS” page using the [▲],[▼] buttons.
“PERCUSS” is on Page B.

3 MOVE THE CURSOR TO THE FUNCTION MODE YOU WISH TO LOCATE

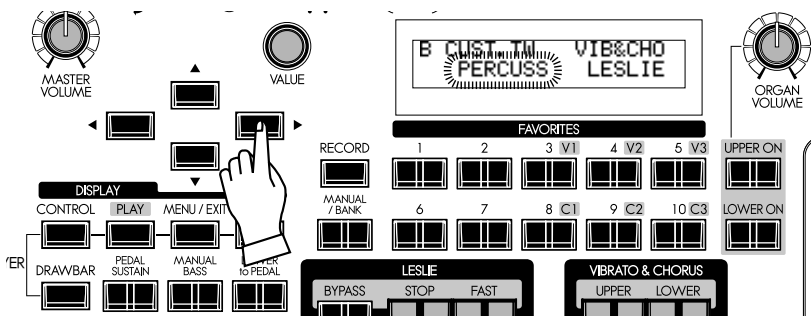

Move the cursor to “PERCUSS” using the [◀],[▶] buttons.

3 PRESS [ENTER]

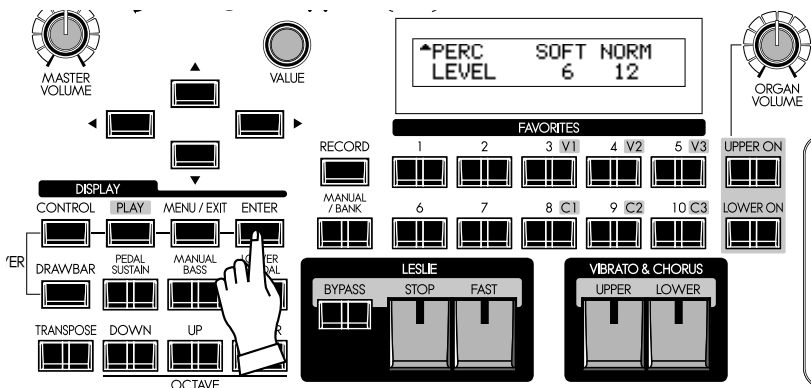

Press the [ENTER] button. The display shows the first page of the Percussion Function mode.

5 MOVE THE CURSOR TO THE PARAMETER YOU WANT TO CHANGE

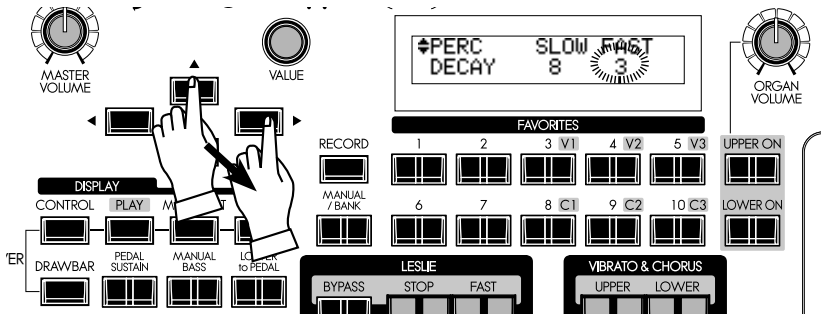

Decay time is on the “DECAY” page. Locate the “DECAY” page using the [▲][▼] buttons.

“FAST” is on the right side of the page move the cursor (blinking value) to the right using the [◀][▶] buttons.

6 CHANGE THE VALUE

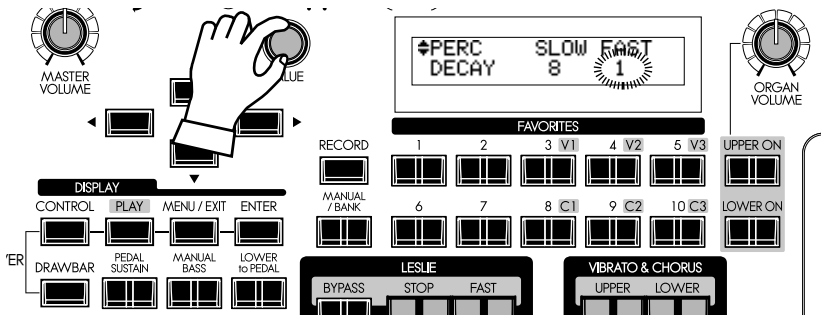

Decrease the value using the [VALUE] knob.

NOTE: If you want to change other items, repeat the process 1 to 6.

7 RETURN TO THE PLAY MODE

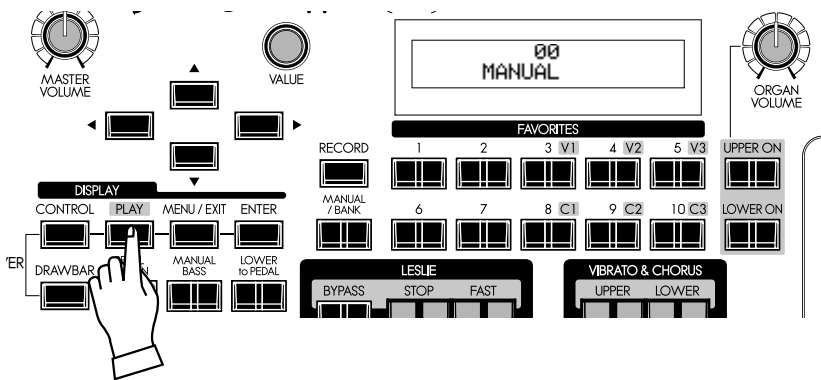

Press the [PLAY] button. The display returns to the Play mode.

8 RECORD TO THE PATCH IF NECESSARY

The parameter “DECAY FAST” is a Patch parameter, so, if you call another (or same) Patch, it is changed to the newly set value.

If you need the changed value hereafter, you must record it to a Patch.

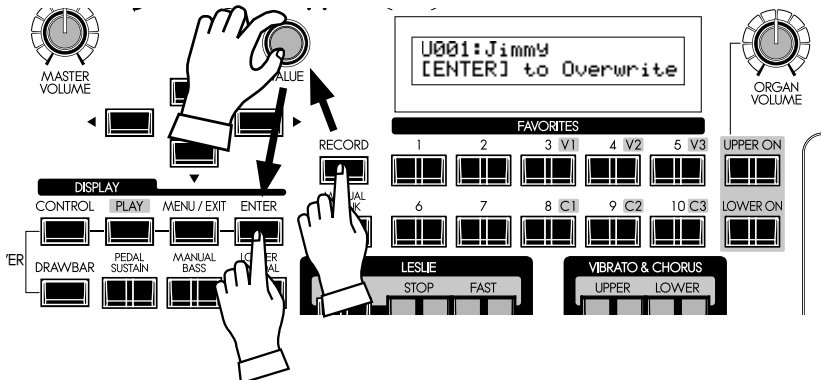

tips PATCH PARAMETERS

Patch Parameters are unique to the current Patch, and change with the programming of each Patch. Many of the knobs/buttons on the top panel are “Patch Parameters”

The Parameters common to all the Patches are called “Global Parameter”, on the contrary.

To make programming quicker and easier, each button on the top panel can be used to access the Function mode page associated with that button instantaneously.

Pressing and holding any of the buttons on the top panel automatically “shortcuts” the display to the related Function mode item.

EXAMPLE OF OPERATION:

LOCATE THE PERCUSSION FUNCTION MODE

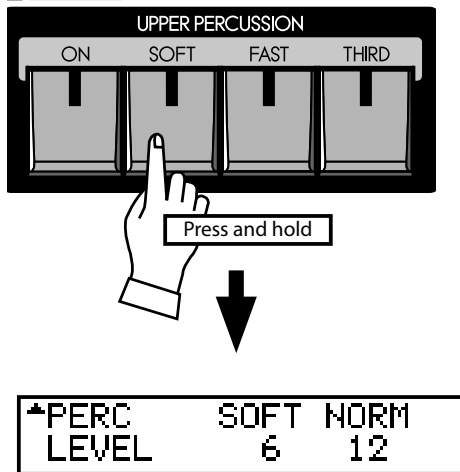

If you wish to edit the Percussion settings, press and hold any of the four Percussion buttons ([ON], [SOFT], [FAST], or [THIRD]), and the display will immediately jump to the Percussion Function mode. This is called “SHORT CUT”.

In the next chapter, you will see which button is used for a particular “SHORT CUT”.

NOTE: Changing the length of time until display jump when button held. (P. 79)

REGISTER THE PAGES YOU FREQUENTLY USE

You can assign frequently-used Function page to the [CONTROL] button for immediate access.

EXAMPLE OF OPERATION:

REGISTER THE “DRAWBAR - PEDAL” PAGE



Display the page you want to register using the MENU etc. Here, as an example, let’s display the “Drawbar - Pedal” page.

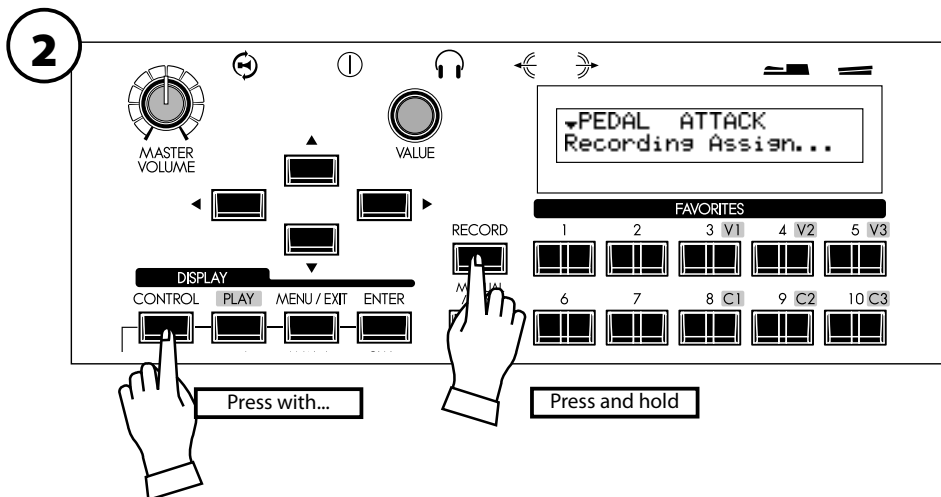

While holding down the [RECORD] button press the [CONTROL] button. You will be able to immediately access the desired page just by pressing the [CONTROL] button.

LOCKING THE DISPLAY

You can lock the display to accidentally changing something in the midst of playing.

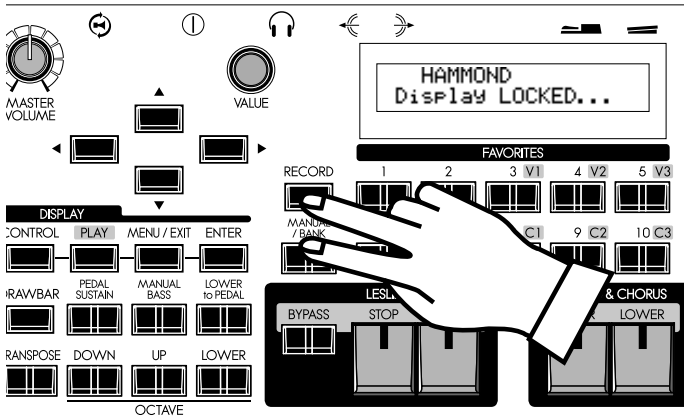

To lock the display, switch [POWER] on with pressing [RECORD] and [MANUAL] until “Display LOCKED” is displayed.

To unlock this, repeat the operation above until “Display UNLOCKED” is displayed.

This function works listed below;

- ◆ [MENU/EXIT] button (P. 64) is disabled
- ◆ [RECORD] button (P. 34) is disabled normally, but you can record the Patch by using “LOCKED 1-10” (P. 70), or you can associate the favorite buttons by using “ASSOCIATE” (P. 74) before locking the display.
- ◆ “Short-Cut” function (P. 69) is disabled
- ◆ [UPPER / LOWER ON] buttons (P. 47) are still enabled.
- ◆ [EXTRA VOICE] buttons (P. 30) are enabled, but the page or cursor is locked on the instrument name.

NOTE: This feature will not be released by Default-All or power on with pressing [RECORD] button.

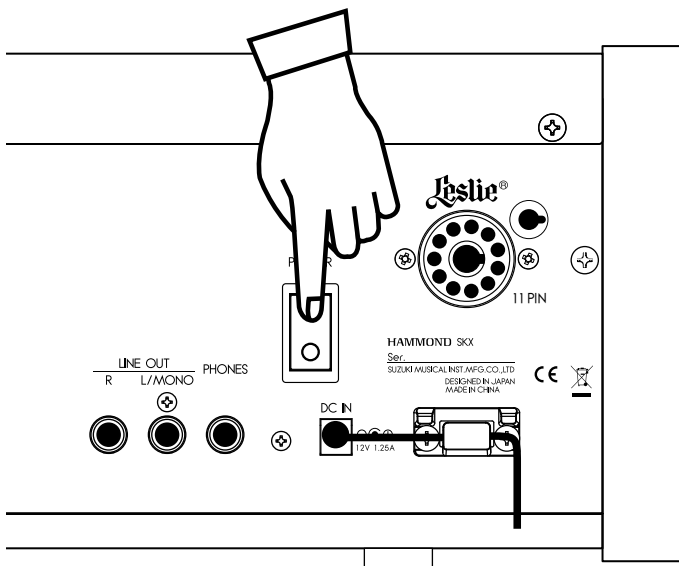

tips USING REGISTERED PAGE

The [CONTROL] button can register a page in Function mode. Even if it locked the display, you can enter the registered page by using [CONTROL] button.

However, you cannot move the cursor if the page has 2 or more parameters.

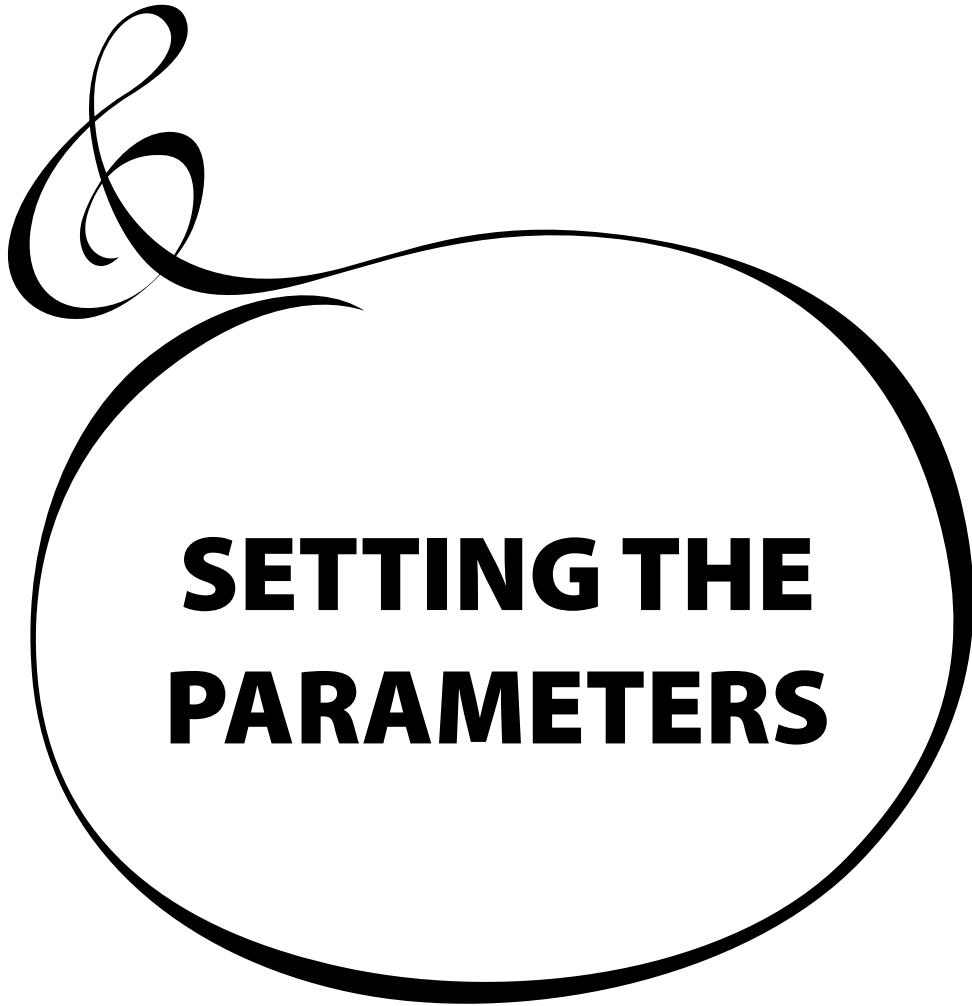
A decorative graphic featuring a large, stylized ampersand (&) on the left side. A thick black line starts from the bottom of the ampersand, curves around to form a large circle, and then continues as a tail on the right side. Inside the circle, the text "SETTING THE PARAMETERS" is written in a bold, black, sans-serif font, centered horizontally and vertically.

**SETTING THE
PARAMETERS**

DRAWBAR

Drawbar sound parameters for each keyboard are set in this mode.

To locate this mode:



See the "Function mode" (P. 66) for operational details.

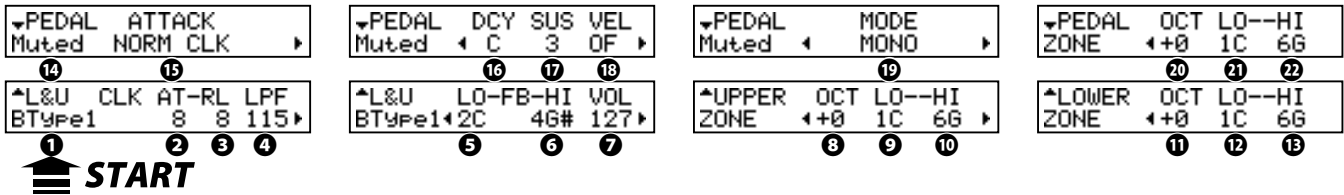

◆ SETTING FOR MANUAL (LOWER & UPPER) DRAWBARS

1 ORGAN TYPE

Select the manual keyboard Organ Type.

- BType1:** Traditional B-3/C-3 Tone Wheel sound
- BType2:** Sound with more leakage noise and wow-flutter
- Mellow:** With transparent sine waves
- Vx:** Transistor Organ, Vx type
- Farf:** Transistor Organ, Farf type
- Pipe:** Pipe Organ

When the Organ Type is set at Vx, Farf, or Pipe, the parameters (2) to (6) are unavailable.

2 CLICK - ATTACK LEVEL

Sets the key-on click volume.

The higher the value, the louder the click gets. No key-click at 4. As the value goes lower than 4, the attack rate becomes slower.

3 CLICK - RELEASE LEVEL

Sets the key-off click volume.

The higher the value, the louder the click gets. No key-click at 4. As the value goes lower than 4, the release rate becomes slower.

4 CLICK - LOW PASS FILTER

Sets the key-click tone.

The setting range is 0 to 127. The higher the value, the brighter the sound.

5 FOLDBACK - LOW

Sets the key-point from which the 16' Drawbar folds back (= repeat the same octave on the lower octaves of the keyboard).

The bottom key on the keyboard is displayed as "1C". The setting range is 1C to 2C.

6 FOLDBACK - HIGH

Sets the key from which the 1' Drawbar folds back (= repeat the same octave on the higher octaves).

The setting range is 4G to 5C.

NOTE: The Fold-back is possible not only with 1' but also with 1½', 1¾', 2', 2¾' Drawbars.

7 ORGAN VOLUME

Set the volume for the entire Organ section. It is related with [ORGAN VOLUME] knob on the top panel. The setting range is 0 to 127.

8 UPPER ZONE OCTAVE

Set the octave shift for the UPPER part. The setting range is -2 to +2.

9 10 UPPER ZONE LOW / HIGH

Set the sounding range of the UPPER part with these two parameters.

tips TONE-WHEEL SET

There are variations available for each virtual ToneWheelset of BType1, BType2 and Mellow. (P.85)

tips KEY CLICK

On the traditional models such as B-3/C-3, a noise occurred when keys were pressed and released, due to the mechanical keying system employed on the classic organs. That characteristic is replicated here.

Loudness

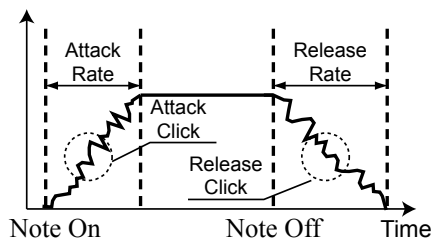

tips EXAMPLES OF KEY-CLICK SETTINGS

Simulation of classic multi-contact keyboard B-3/C-3: AT = 8, RL = 8

Simulation of a PCM synthesizer to produce the key-click only at 'attack': AT = 8, RL = 4

Slow envelope like a pipe-organ: AT = 0, RL = 0

tips FOLDBACK

As the number of the Tone Wheels was limited on the B-3/C-3, the very highest and lowest pitches "folded back" on the keyboards, sounding the same octave twice in a row. This function reproduces this characteristic.

tips HOW DOES THE ORGAN VOLUME WORK?

The organ volume adjusts just the volume after multi-effects unlike the Expression. It is useful for set the volume of each Patch, or set the level balance between organ and extra voice section.

11 LOWER ZONE - OCTAVE

Set the octave shift for the LOWER part. The setting range is -2 to +2.

12 13 LOWER ZONE - LOW / HIGH

Set the sounding range of the LOWER part with these two parameters.

◆ SETTING THE PEDAL PART**14 ORGAN TYPE**

Set the Organ Type for the Pedal part.

- Normal:** The traditional Tone Wheel sound of the B-3/C-3.
- Muted:** Analog oscillating sound as heard on the Classic X-5.
- Synth1:** Saw-tooth waveform with the filter-sweep.
- Synth2:** Dull square wave.
- Finger:** Electric bass, played by forefinger.
- Pick:** Electric bass, played by the pick with muted.
- Slap:** Electric bass, played with slap style.

When the "Pipe" Organ Type is selected by (1), only Pipe Organ pedal sounds are heard, regardless of this parameter. Also, parameters (15) to (18) are unavailable.

15 ATTACK

This allows you to set the Pedal Attack Rate and the Key-Click Volume at 'attack' and 'release'.

- MAX CLK:** Immediate attack and the key-click is loud.
- NORM CLK:** Immediate attack and the key-click is normal.
- SOFT CLK:** Immediate attack and the key-click is soft.
- NO CLK:** A slightly slower attack without key-click.
- SLOW:** Slow attack without key-click.

16 DECAY RATE

This allows you to determine whether the Pedal voice remains at the same volume as a note is held, or if the voice decays, as like a plucked string.

The setting range is 1(short) - 5(long) and C(continuous).

17 SUSTAIN LENGTH

This allows you to set the Release Rate (= the decay time after key release), when the [PEDAL SUSTAIN] button is ON.

The setting range is 1(short) - 5(long).

NOTE: You can locate this page by holding down the [PEDAL SUSTAIN] button as well.

18 VELOCITY

This allows you to set the response to the Velocity. The setting range is OF and 1 - 4. At OF, the volume does not change however hard you play the key. As the value increases from 1 - 4, the sounds gets louder even if the key is played softly.

19 KEY MODE

This allows you to set the Pedal polyphony.

- MONO:** If multiple notes are played, only the lowest note will sound.
- POLY:** Up to 8 notes will play simultaneously.
- LAST:** The last note you played will sound.

When using Manual Bass (P. 32), the PEDAL part sounds its own mode (P. 110) regardless of the setting of this parameter.

20 PEDAL ZONE - OCTAVE

Set the octave shift for the Pedal part. The setting range is -2 to +2.

21 22 PEDAL ZONE - LOW / HIGH

Set the sounding range for the PEDAL part with these two parameters.

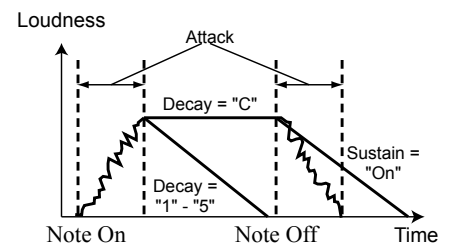
**tips SUSTAIN**

Unlike synthesizer nomenclature, on the SKX "Sustain" refers to note decay after note release. On a synth envelope generator this setting would be called "T4" or "Release".



Key Mode and sounding

tips ZONE

The "ZONE" in these pages sets sounding range for each part of the Organ section which from -2C to 8G. It comes from range of MIDI note numbers. The internal sound engine of the SKX receives all the MIDI note number against internal keyboards which has 5 octave, 1C to 6C.

There are more "ZONE", Internal Zones and External Zones. See page 106 for details.

NOTE: All the parameters in these pages are Patch Parameters. They are recorded into the Patch.

PATCH

In this mode you can name your Patch, set which parameters load, and how to link to the Favorite buttons.

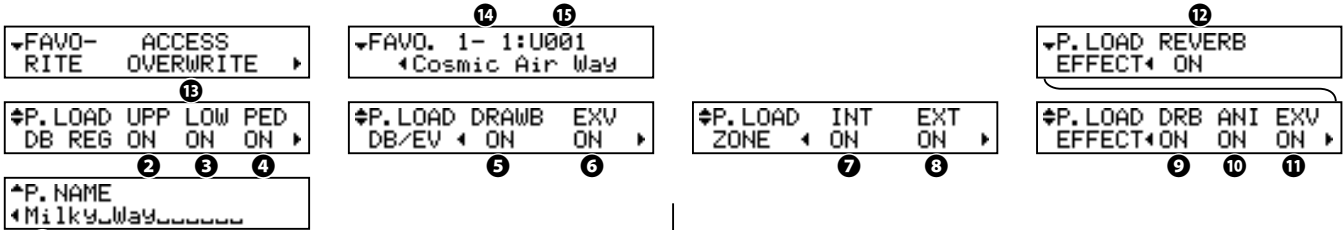
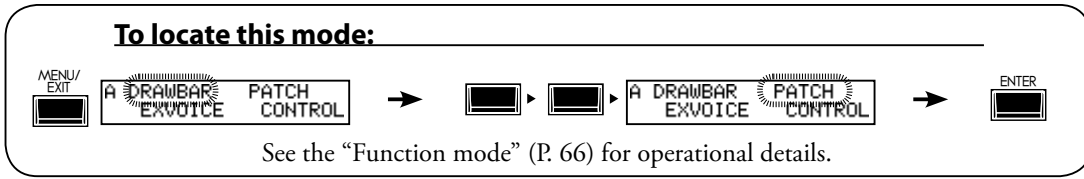

START

◆ **PATCH NAME**

❶ **Patch Name (P)**

Name the present Patch using up to 15 letters. Move the cursor by the [◀][▶] buttons. Then select letters with the [VALUE] knob. The Patch name is lost, unless you save the Patch. **NOTE: This parameter (P) is a Patch parameter. It is recorded in each Patch.**

◆ **PATCH LOAD**

These are for setting which parameters are loaded when a Patch is called. Sets whether or not to load:

❷ ❸ ❹ **PATCH LOAD - DRAWBAR REGISTRATION (G)**

Drawbar registration of the UPPER, LOWER and PEDAL part.

❺ **PATCH LOAD - DRAWBAR (G)**

The parameters specific to the Organ Section such as Organ Type or Percussion.

❻ **PATCH LOAD - EXTRA VOICES (G)**

Extra Voice parameters.

❼ **PATCH LOAD - INTERNAL ZONE (G)**

The parameters relating with Internal Zone or Coupler (Pedal to Lower and Manual Bass).

❽ **PATCH LOAD - EXTERNAL ZONE (G)**

The parameters specific to the External Zone to control external MIDI equipment.

❾ **PATCH LOAD - DRAWBAR EFFECT (G)**

The parameters specific to the Organ Section Effects (Overdrive, Multi-Effects, Equalizer).

❿ **PATCH LOAD - ANIMATION (G)**

The parameters specific to the Leslie, Vibrato & Chorus effects.

⓫ **PATCH LOAD - EXTRA VOICE EFFECTS (G)**

The parameters specific to the Extra Voice Section Effects (Overdrive, Multi-Effects and Equalizer).

⓬ **PATCH LOAD - REVERB (G)**

The Reverb parameters.

NOTE: Each Patch Load parameter is a Global parameter. It is recorded when the value is set. Common for each Patch.

◆ **FAVORITES**

⓭ **FAVORITE ACCESS (G)**

Allows you to select how the Favorite buttons function.

ASSOCIATE:

Each number button usually calls the related Patch. If you touch each number button holding down the [RECORD] button, it relates the number button to the currently selected Patch.

OVERWRITE:

In addition to above, if you touch each number button holding down the [RECORD] button, it records the current setting to the selected Patch.

LOCKED 1-10:

The Favorites and Patches made fixed linkage. Each number button usually calls the corresponding Patch, U001 ... U100 by with using [BANK] button together. If you touch each number button holding down the [RECORD] button, it records the current setting to the corresponding Patch, U001 ... U100.

DIRECT:

This is for directly calling the Patch, using each number button. To call the Patch, first put in the 3 digit Patch number and then touch the [ENTER] button.

- U001 ... [1], [ENTER]
- U010 ... [1], [10], [ENTER]
- U100 ... [1], [10], [10], [ENTER]
- P001 ... [1], [10], [1], [ENTER]
- P010 ... [1], [1], [10], [ENTER]
- P100 ... [2], [10], [10], [ENTER]

You can not relate the Patch to each number button.

⓮ **FAVORITE - BANK / NUMBER (G)**

⓯ **FAVORITE - PATCH (G)**

Displays and changing the Patches related with each Number button [1] - [10].

You can enter the these page by pressing and hold the Number button [1] - [10] also.

NOTE: "G" means "Global". These parameters will be recorded when set, and are common in each Patch.

In this mode the basic Extra Voice settings are made such as the Extra Voice instrument and volume.

To locate this mode:

or, touch either button in the voice group.
See “Function mode” (P. 66) for operation details.

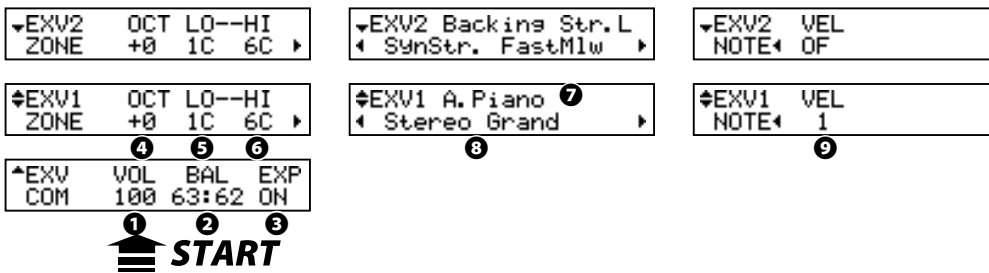

1 VOLUME

Adjust the volume of the entire Extra Voice sections here. It is linked with the [VOLUME] knob on the top panel.
The setting range is 0 to 127.

2 BALANCE

Adjust the volume balance between Extra Voice section 1 and 2. It is linked with the [BALANCE] knob on the top panel.
The setting range is 64:0 - EVEN - 0:63. It makes same volume balance at EVEN.

3 EXPRESSION

Sets the ON (enable) or OFF (disable) the Expression control of the entire Extra Voice sections.

NOTE: This parameter cannot set for each Extra Voice section.

4 ZONE - OCTAVE

Sets the playing octave for the Extra Voice section.
The setting range is -2 to +2.

5 ZONE - LOW

6 ZONE - HIGH

Sets the sounding range in the Extra Voice section with these two parameters.

7 VOICE GROUP

Sets the Voice Group. Choices are in the range of “A. Piano” to “Library”, same as the [VOICE GROUP] buttons on the top panel.

The operation of this parameter is different with which [VOICE GROUP] button is selected.

A. PIANO, E. PIANO:

According with each [VOICE GROUP] button, not selectable.

OTHER:

Selects “Keyboard”, “Wind” or “Others”.

LIBRARY:

Selects the loaded Voice Libraries. “Tr. Organ VxJ” is pre-loaded.

8 INSTRUMENT

Selects the instrument in the Voice Group.

Consult the instrument list at the back of this manual (P. 136) for details.

9 VELOCITY

Sets the response to the velocity (strength of the key touch) of the Extra Voice section.

The setting range is OF, 1 to 4. At OF keys sound at a certain volume, regardless of the key touch strength (like an organ’s touch). “1” is the most exaggerated velocity curve while “4” is a gentler curve. “2” and “3” are curves in between.

NOTE: All the parameters in this mode are Patch parameters, and are recorded to each Patch.

tips OPERATING THE OTHER AND LIBRARY

The [OTHER] and [LIBRARY] button contains the 2 or more Voice groups. You can select this by pressing the each [OTHER] or [LIBRARY] button again instead of the turning the [VALUE] knob at the VOICE GROUP parameter.

tips LINK BETWEEN INSTRUMENTS AND OTHER PARAMETERS

When an instrument is selected, each parameter of the Octave, the Multi-Effects, the Equalizer, Expression and the ProChord (although not displayed), is automatically set at the recommended value.

CONTROL

This mode is for setting the various controls.

The Foot Switch and Expression Pedal requires setting before using if connected. It is possible to assign the [OCTAVE] buttons to other functions.

To locate this mode:



or, touch the [CONTROL] button.

See “Function mode” (P. 66) for operation details.

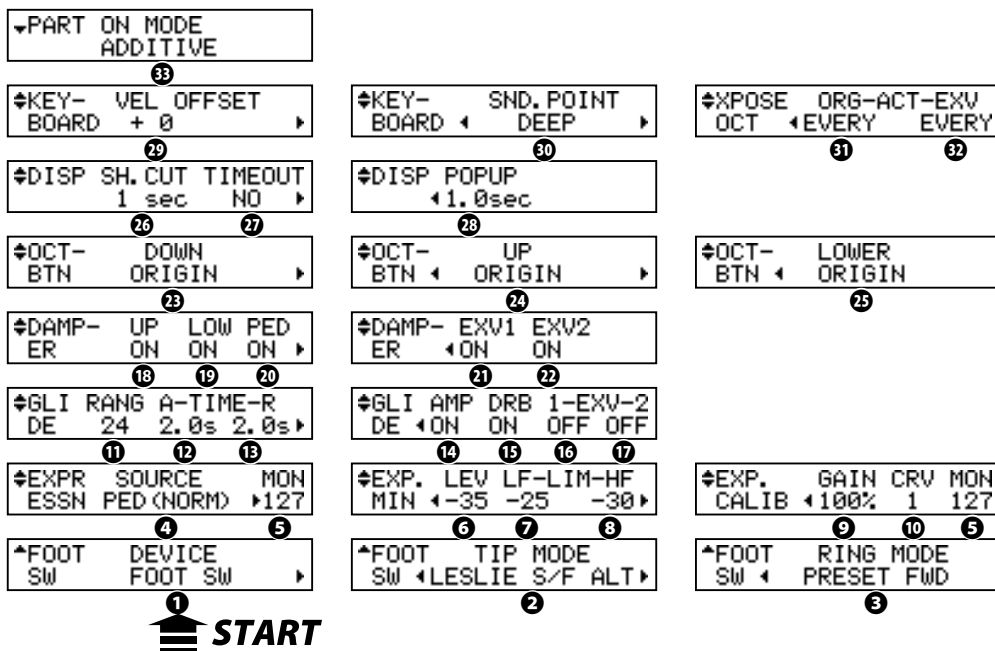

◆ FOOT SWITCH

1 FOOT SWITCH - DEVICE (G)

This is for selecting the equipment connected to the FOOT SWITCH jack.

FOOT SW: Foot Switch connected.

CU-1: Optional Leslie Mode Switch (CU-1) connected.

2 FOOT SWITCH - TIP MODE (G)

This sets the Foot Switch function.

OFF:..... Does not function.

LESLIE S/F ALT, MOM, TRI:

Switches the Leslie Effect Slow/Fast/Stop.

At **ALT**, Fast / Slow or Stop (as set by the [STOP] button) is toggled every time the foot switch is pressed. At **TRI**, it is switched to Stop when the foot switch is further held down for longer than a second.

At **MOM**, it is switched to Fast only while the foot switch is held down. When released it switches to Slow or Stop (as set by the [STOP] button).

GLIDE:..... The pitch bends while the foot switch is pressed. The glide interval and glide speed is determined by the GLIDE - RANGE and GLIDE - TIME settings.

PATCH FWD, REV:..... Switches the Patch Forward or Reverse.

FAVORITE FWD, REV: ... Switches the Favorite Forward or Reverse.

SPRING:..... This generates the sound of the spring reverb being shaken.

DELAY TIME:..... This is for setting the delay time (P. 99) of the Reverb, at the interval of tapping the foot switch. The delay sound goes out, while the foot switch is held down.

MUSIC START:..... Controls the Start/Stop of the Music Player.

MANUAL BASS:..... Triggers the Manual Bass (P. 32) note of Pedal part.

tips TIP AND RING

The typical stereo plug, there are 3 metal parts. The end is called the “Tip”, the middle portion is the “Ring”. The part on the cord side is called the “Sleeve”.

The SKX requires a foot switch that uses a Stereo Jack. Two Mono-Jack foot switches may be used, and can have discrete functions, if a Left/Right stereo splitter is used.

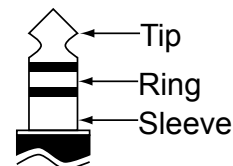

tips SPRING REVERB

The Hammond Organ company actually invented the spring reverb for its organs in the 1940's. The effect was obtained with a length of spring and a few pickups. If the spring was disturbed, it would make a large crashing noise that was usually considered a nuisance, but sometimes was used as a program sound effect. The Reverb here is digital, but the “crash” effect is re-created here.

BASS 1C - BASS 3C:..... Triggers the specific Pedal part note.

PROCHORD CLOSE, OPEN:

Triggers the ProChord note for the Organ section with specified voicing (close or open).

3 FOOT SWITCH - RING MODE (G)

This sets the Ring side function, when the foot switch connected to the foot switch jack is of the TRS specifications.

NOTE: The "ProChord" function cannot be chosen via the "ring".

◆ EXPRESSION

4 EXPRESSION - SOURCE (G)

Sets the source of Expression control.

PED (NORM):

For the (Optional) Hammond-Suzuki EXP-50J pedal etc.

PED (REV):

For using a Korg XVP-20 type of Expression Pedal etc.

MIDI: For using Expression information received at the UPPER Keyboard channel.

BOTH (NORM), BOTH (REV):

Expression value will be controlled by both pedal and MIDI in.

5 EXPRESSION - MONITOR

Displays the current value of Expression. In case of no sound or no change when the Expression pedal is pressed, this monitor shows whether the Expression value changes or not, so you may discover the cause of trouble (if any). This can also be an indicator when playing from low volume to fade in.

6 EXPRESSION - MINIMUM LEVEL (G)

Sets the volume at minimum Expression.

The setting range is OFF, -40dB to 0dB. At OFF the keyboard is silent when Pedal is at Minimum (all the way back). The other value points represent the lowest volume that will be present at the Pedal's minimum position.

7 EXPRESSION - LIMIT LOW FREQUENCY (G)

8 EXPRESSION - LIMIT HIGH FREQUENCY (G)

Sets the amount of Low or High Frequency to remain, when the Expression is set at minimum.

The setting range is OFF, -40dB to 0dB. At OFF the sound totally disappears, but at other value points the set volume is kept, even if the Expression is at minimum.

9 EXPRESSION - GAIN (S)

Sets the gain (range) of the connected Expression pedal.

The setting range is 70 to 130%.

Depending on the type of the connected Expression pedals, the Expression value may not change enough. In such case, adjust this parameter to obtain the desired response.

10 EXPRESSION - CURVE (S)

Adjusts change of Expression value corresponding to the angle of the depressed Expression pedal.

The setting range is 1 to 3. Refer each curve to the bottom right illustration or try playing live to discern which curve is correct for you.

NOTE: The parameters indicated by (S) are system parameters. They are recorded when set, and are common in each Patch.

tips PROCHORD

"ProChord" function which adds complex harmonic voicing to single notes played on the UPPER manual based on chord structures played on the LOWER manual.

The ProChord by the foot switch affects only for the Organ section.

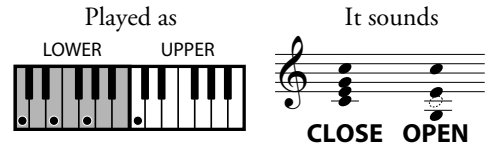

tips EXPRESSION LIMIT

One of the human ear's characteristics is that when the volume falls, the sound of the high or low frequencies becomes difficult to hear. Using Expression limit, you can hear the revised frequency response.

Vintage B-3/C-3 preamps age in different ways—one symptom is the organ's timbre may change with Expression pedal travel. This is a desirable characteristic for some.

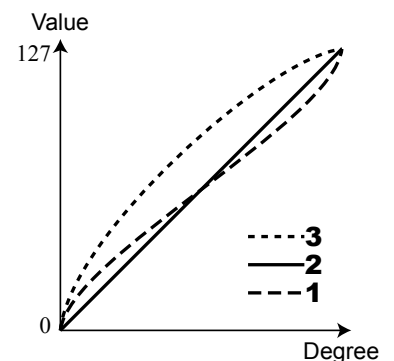
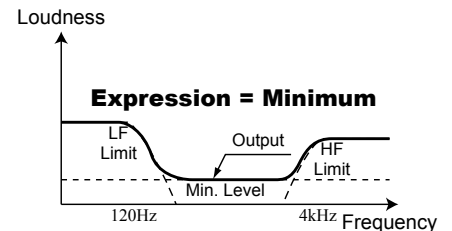
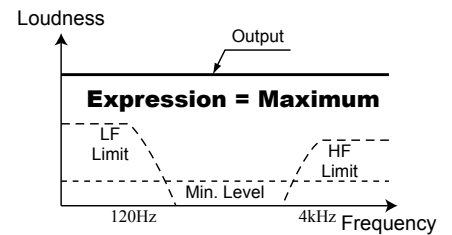

NOTE: The parameter with (P) indicated is a Patch parameter, and is recorded to each Patch. (G) indicates "Global parameter", which is recorded upon being set, and is common with each Patch.

PART ON MODE ADDITIVE		
KEY- VEL OFFSET BOARD + 0	KEY- SND. POINT BOARD ← DEEP	XPOSE ORG-ACT-EXV OCT ← EVERY EVERY
DISP SH. CUT TIMEOUT 1 sec NO	DISP POPUP ← 1.0sec	
OCT- DOWN BTN ORIGIN	OCT- UP BTN ← ORIGIN	OCT- LOWER BTN ← ORIGIN
DAMP- UP LOW PED ER ON ON ON	DAMP- EXV1 EXV2 ER ← ON ON	
GLI RANG A-TIME-R DE 24 2.0s 2.0s	GLI AMP DRB 1-EXV-2 DE ← ON ON OFF OFF	
EXPR SOURCE MON ESSN PED (NORM) 127	EXP. LEV LF-LIM-HF MIN ← -35 -25 -30	EXP. GAIN CRV MON CALIB ← 100% 1 127
FOOT DEVICE SW FOOT SW	FOOT TIP MODE SW ← LESLIE S/F ALT	FOOT RING MODE SW ← PRESET FWD

1 **START**

◆ **GLIDE**

11 GLIDE - RANGE (P)

Sets the pitch-bend range by semitone. Setting range is -24 to +12.

12 GLIDE - ATTACK TIME (P)

Sets the amount of time for the Glide effect to reach the pitch set at (11). The setting range is 0.1 to 5.0 seconds.

13 GLIDE - RELEASE TIME (P)

Sets the amount of time to return to normal pitch when the Glide is released.

14 GLIDE - AMP (P)

Engages a “fade” along with the Glide, where the volume drops in tandem with the pitch to total silence.

15 GLIDE - DRAWBARS (P)

16 GLIDE - EXTRA VOICE 1 (P)

17 GLIDE - EXTRA VOICE 2 (P)

Assigns the Glide to the various sections of SKX. (15) is for Organ section, and (16) and (17) are for the Extra Voice section.

◆ **DAMPER**

18 DAMPER - UPPER (G)

19 DAMPER - LOWER (G)

20 DAMPER - PEDAL (G)

21 DAMPER - EXTRA VOICE 1 (G)

22 DAMPER - EXTRA VOICE 2 (G)

Assigns the Damper function to the various divisions of the SKX.

(18), (19) and (20) are for setting each part of the Organ section, and (21) and (22) are for the Extra Voice section.

◆ **ASSIGN**

23 OCTAVE BUTTON - DOWN (G)

24 OCTAVE BUTTON - UP (G)

25 OCTAVE BUTTON - LOWER (G)

Used to assign extra functions other than the original ones to the [OCTAVE] but-

tips **GLIDE**

Since there is no pitch-bend function on the B-3/C-3, some musicians would get a pitch-bend effect by quickly turning the power to the organ “OFF” then “ON”.

If the RUN switch on a B-3/C-3 is turned off, the Tone Wheel motor gradually slows down and stops, and the amplifier turns off as well. You can replicate this effect using this function.

The SKX has added some parameters for Extra Voice section to use as a simple pitch bend.

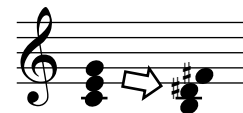

When Glide range is set at “-1”.

tips **DAMPER**

Or “Sustain” pedal-analogous to the RIGHT pedal on a piano. Sounds are held when this pedal is depressed. Called “Damper” due to the fact that when the pedal was depressed on a piano, the mechanism that muted or “damped” the strings was raised, allowing the piano strings to ring free.

tons.

- ORIGIN:**..... Works according to the buttons' original function.
- LES STOP, LES FAST:**..... Similar to the [LESLIE STOP], [LESLIE FAST] buttons.
- VIB UPPER, VIB LOWER:**
..... Similar to the [VIBRATO UPPER], [VIBRATO LOWER] buttons.
- GLIDE:**..... This is for activating the Glide function.
- SPRING:**..... This is for producing the shock noise of the Spring Reverb.
- DELAY TIME:**..... Sets the Delay Time (P.99) by tapping the button at the interval you wish the delay to be set. If you keep pressing the button, the Delay sound disappears.
- PRIO UPPER, PRIO LOWER:**
Priority on Drawbars - Temporarily substitutes the Upper registration with Upper or Lower Drawbar settings instead of the Patch content.

◆ **DISPLAY**

- 26 DISPLAY - SHORTCUT (G)**
Sets the shortcut waiting time.
The setting range is 0 to 2 seconds. At NO the shortcut feature is disabled.
- 27 DISPLAY - TIME OUT (G)**
Sets the time for returning to the previous mode from the mode displayed by the shortcut operation.
The setting range is 4 to 16 seconds. At NO the screen will not return to the previous mode.
- 28 DISPLAY - POP UP (G)**
Sets the interval at which the Pop Up is displayed when you move the [OVER-DRIVE] or [EFFECT AMOUNT] knob.
The setting range is 0.5 to 2 seconds. At NO no Pop Up is displayed.

◆ **KEYBOARD**

- 29 VELOCITY OFFSET (S)**
Fine-adjusts the keyboard velocity to personal taste. The setting range is -32 to +32. If your touch is heavy, set this parameter to a negative value, if your touch is light, set the parameter to a positive value.
- 30 SOUNDING POINT (S)**
Set the sounding point if the internal keyboard is played.
DEEP: All the section sounds on the deep point in the stroke.
AUTO: The Organ section sounds on the shallow point if the [UPPER ON] / [LOWER ON] of the Extra Voice section are "OFF".
NOTE: The External Zone sends notes on at shallow point, and the velocity value is fixed at 100 when the Sounding Point is set at AUTO, and the [UPPER ON] [LOWER ON] of the Extra Voices are "OFF".

- 31 TRANSPOSE/OCTAVE ACT - ORGAN (S)**
- 32 TRANSPOSE/OCTAVE ACT - EXTRA VOICE (S)**
Set the whether Transpose instantly or not by pressing the [TRANSPOSE] and [OCTAVE] buttons.
EVERY: The transposed notes sounds at every pressed the buttons.
NEXT: The transposed notes sounds at next note on.

◆ **PART**

- 33 PART ON - MODE (G)**
Sets how performs [ON] buttons of the Organ Section and Extra Voice Section.
ADDITIVE: Each [ON] button turns its respective section "ON" and "OFF" independently.
ALTERNATE: Each [ON] button cancels the other on the same part. For example, the Organ [UPPER ON] button, when switched "ON", will turn the Extra Voice [UPPER ON] button "OFF". To turn both sections "ON", press the two buttons simultaneously.

tips DRAWBAR PRIORITY

PRIO UPPER and PRIO LOWER allows to make playing style which using Adjust Preset keys [A #] or [B] of the B-3/C-3 (below figure).

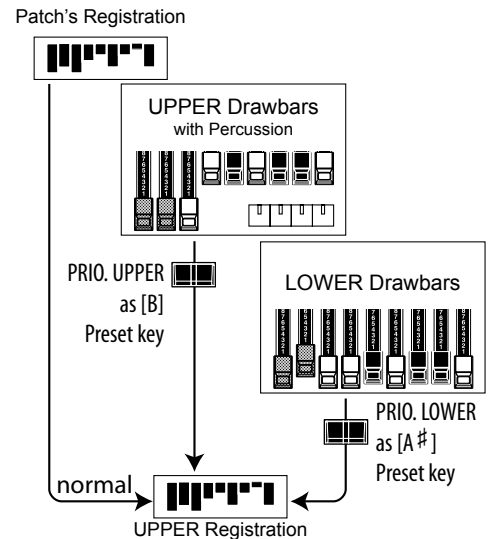

For example, during the button for PRIO LOWER (right side in the figure) is "ON", the UPPER registration can be controlled only via LOWER Drawbars.

UPPER Drawbars (center in the figure) does not affect any parts.

By using this manners, you can preparing the "next" registration on the UPPER Drawbars during playing, and switch on the button for PRIO UPPER to use the registration on the UPPER Drawbars immediately.

NOTE: The Percussion does not sound during the PRIO LOWER is ON.

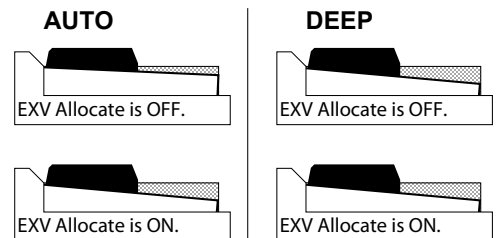

Sounding Point and keystroke.

NOTE: The parameter with (P) indicated is a Patch parameter, and is recorded to each Patch. (G) indicates "Global parameter", (S) indicates "system parameter", which is recorded upon being set, and is common with each Patch.

PERCUSS (Percussion)

This mode is for setting the parameters of the Percussion sounds.

To locate this mode:

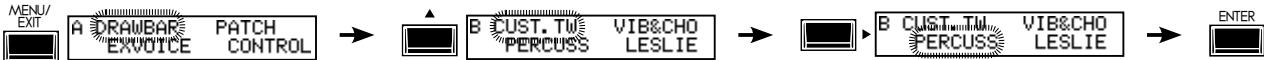

or, keep pressing either of the [ON], [SOFT], [FAST], [THIRD] buttons for a moment.

See “Function mode” (P. 66) for operation details.

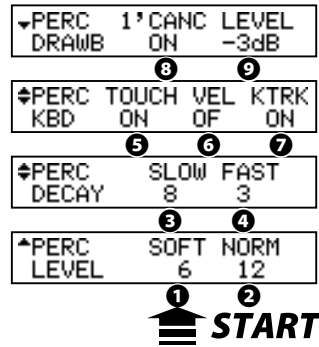

1 LEVEL SOFT

2 LEVEL - NORMAL

Controls the Percussion volume levels. The Normal level is set by the NORM setting, and SOFT is the level when the [SOFT] button is ON.

3 DECAY - SLOW

4 DECAY - FAST

Controls the Percussion decay time. The Slow rate is set by SLOW setting, and Fast is the time when the [FAST] button is ON.

The setting range is 1 to 9 and C. As the value is raised, the decay time grows longer. At C (continuous) there is no decay, and the Percussion sound is sustained while keys are pressed.

5 KEYBOARD - TOUCH

Sets the touch response of the Percussion.

ON: Legato playing will result in the First note hit engaging the Percussion, and none after.

OFF: The envelopes reset with each key hit and Percussion sounds on every note.

6 KEYBOARD - VELOCITY

Links the Percussion volume to velocity.

ON: A harder strike produces a louder Percussion sound.

OFF: Regardless how hard you play, the volume remains the same.

7 KEYBOARD - KEY TRACK

Attenuates the Percussion volume by position of the key.

ON: The higher the note is, the lesser the volume.

OFF: no change in volume.

8 DRAWBAR - 1' CANCEL

Mutes the UPPER 1' Drawbar while using the Percussion.

ON: Mute active

OFF: No mute.

9 DRAWBAR - LEVEL

Reduces the UPPER Drawbar volume while using the Percussion (except [SOFT] button is ON).

-5dB: Reduces the volume in similar response to the classic B-3/C-3.

-3dB: Slight reduction in volume.

0dB: Does not reduce the volume.

NOTE: All the parameters of these modes are Patch parameters, and are recorded to the respective Patches.

tips TOUCH-RESPONSE

The Percussion generator on the vintage B-3/C-3 had a single envelope, which would not recycle until all keys were raised. Originally thought to be a defect, the resulting response became a desired trait.

tips 1' CANCEL

The B-3/C-3 had no exclusive key contact for the Percussion, but, used the 1' contact. This is simulated on the SKX.

tips DRAWBAR LEVEL

When the Percussion was activated on the B-3/C-3, the volume of the Drawbars became slightly softer in volume. This is simulated on the SKX.

In this mode, the settings specific to Vibrato and Chorus are adjusted.

To locate this mode:



or, keep pressing either of the VIBRATO & CHORUS [UPPER], [LOWER] buttons for a few seconds.

See “Function mode” (P. 66) for operation details.

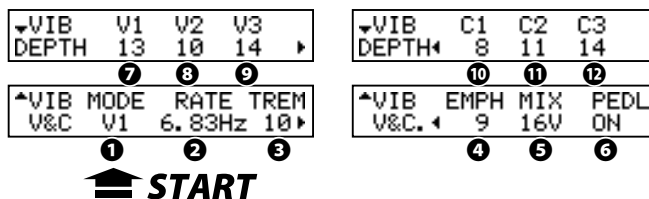

1 MODE

Sets the Mode of the Vibrato and Chorus effect.

- V1 (C1):** light vibrato (chorus)
- V2 (C2):** vibrato (chorus) of standard depth.
- V3 (C3):** deepest vibrato (chorus)

“Chorus” makes richness to the sound with blending direct and vibrato tone.

This Mode can be selected on the top panel by holding each [VIBRATO & CHORUS] button and press [V1] to [C3] button (right figure).

2 RATE

Sets the Speed of the Vibrato and Chorus effect.
The setting range is 6.10 - 7.25 Hz.

3 VIBRATO - TREMOLO

Sets Tremolo (amplitude modulation) of the Vibrato and Chorus effect.
The setting range is 0 - 15.

4 EMPHASIS

Sets Emphasis (high frequency boost) of the Chorus effect (C1 / C2 / C3).
The setting range is 0 - 9 dB.

5 MIX

Sets Mixing ratio of the Chorus effect (C1 / C2 / C3).
The setting range is D64 (only the Direct tone, no vibrato tone) - EVEN - 63V (only the Vibrato tone, no direct tone).

6 PEDAL

Sets Vibrato and Chorus affects on the Pedal part by [LOWER] button.
The setting range is ON/OFF.

7 DEPTH V1, 8 DEPTH V2, 9 DEPTH V3, 10 DEPTH C1, 11 DEPTH C2, 12 DEPTH C3

Sets the Depth of each Vibrato and Chorus effect mode.
The setting range is 0 - 15.

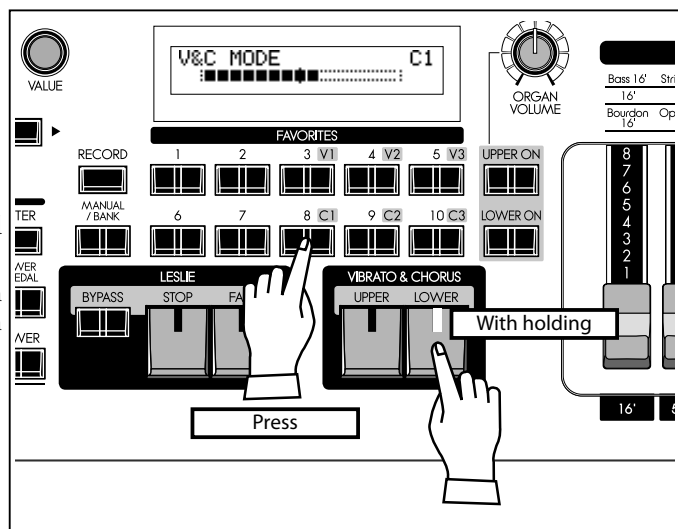

Setting the Vibrato & Chorus Mode

tips PEDAL

On the vintage B-3/C-3, the Vibrato and Chorus affects not only LOWER part but also PEDAL part via [LOWER] (exactly, “GREAT”) tablet by the circuit structure. It is divided on later models.

This parameter simulates that.

NOTE: All the parameters in these modes are Patch Parameters. They are recorded into the Patch.

In this mode, the settings are made for the built-in Leslie Effect and the External Leslie Speaker.

There are many parameters related to the Leslie functions, to make this easier to edit and use.

The built-in Leslie parameters are grouped in macro-settings called "CABINETS". You select the CABINET NUMBER in the Combination Presets where this selection is saved as part of the Preset.

To locate this mode:

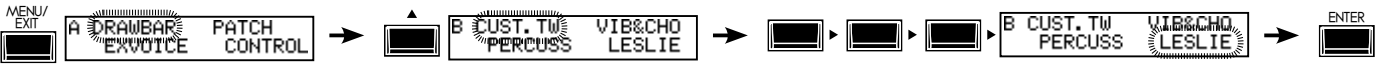

or, keep pressing either of the [BYPASS], [STOP], [FAST] buttons for a few seconds.

See "Function mode" (P. 66) for operation details.

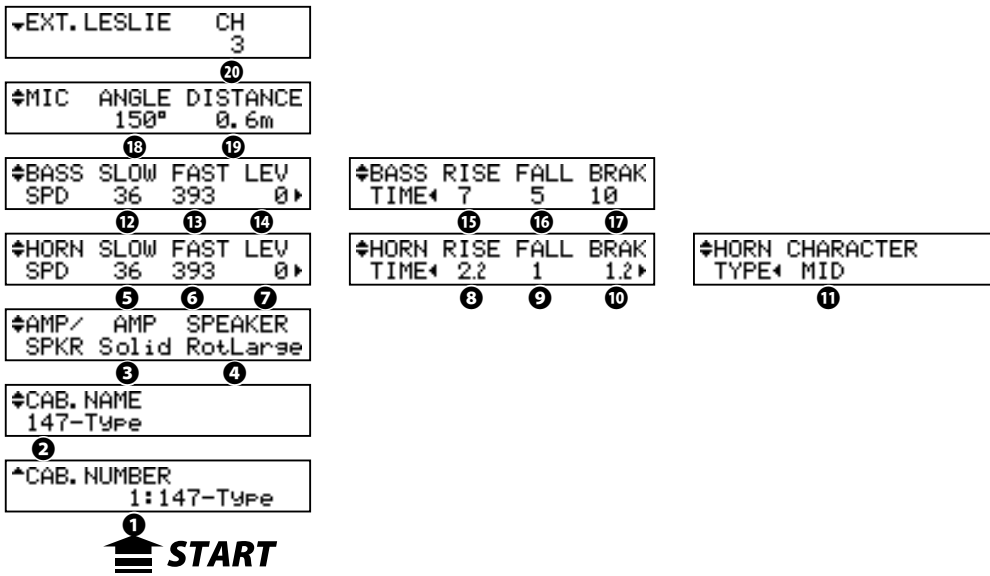

◆ **CABINET NUMBER**

❶ **CABINET NUMBER (P)**

Selects the Cabinet Number to use in the Patch.

The setting range is P1 to P8 (non-rewritable) and U1 to U8 (rewritable). If the Leslie parameter is changed, "*" is displayed on the left side.

◆ **LESLIE PARAMETERS**

❷ **CABINET NAME (L)**

Sets the Cabinet Name by up to 10 characters.

Move the cursor with the [◀][▶] button and select letters with the [VALUE] knob. The available characters include: Punctuation Marks (space - . ' &c), Numeric Characters (0 - 9), Upper-case Letters ("A - Z"), and Lower-case Letters ("a - z").

The name and following (L) parameters are not recorded until the Cabinet Macro is recorded into memory (See the next paragraph.)

❸ **AMP (L)**

This is for setting the type of the virtual Power Amplifier.

Solid: Solid-state(transistorized) Amplifier

Tube: Tube Amplifier.

❹ **SPEAKER (L)**

This is for setting the virtual Speaker.

RotSmall: A small Leslie speaker, such as the Leslie 145

RotLarge: A large Leslie speaker, such as the Leslie 122

Station: A fixed speaker, such as the Hammond PR-40

tips **CONCEPT OF THE CABINET NUMBER**

One Cabinet is equivalent to a virtual Leslie speaker made with the Leslie parameter.

This is a Patch parameter.

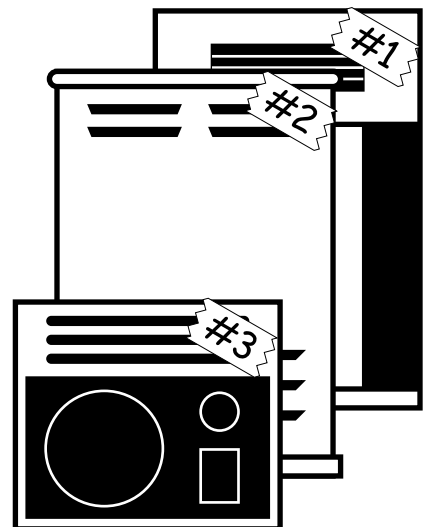

5 SLOW SPEED - HORN (L)**12 SLOW SPEED - BASS (L)**

Sets the speed of the Rotors in Slow mode.
The setting range is 0, 24 to 318 rpm. At 0, no rotation.

6 FAST SPEED - HORN (L)**13 FAST SPEED - BASS (L)**

Sets the speed of the Rotors in the Fast mode.
The setting range is 0, 375 to 453 rpm. At 0, no rotation.

7 HORN LEVEL (L)**14 BASS LEVEL (L)**

Sets the volume of the Rotors, Horn and Bass. The setting range is 0 to -12dB.

8 RISE TIME - HORN (L)**15 RISE TIME - BASS (L)**

Sets the time for the Rotors to “ramp up” to the “Fast” speed, when switching either from “Slow” or “Stop” mode.

The setting range for the Horn Rotor is 0.2 to 5.0sec., and the Bass Rotor is 0.5 to 12.5sec.

9 FALL TIME - HORN (L)**16 FALL TIME - BASS (L)**

Sets the time for the Rotors to “coast down” to “Slow” speed, when switching from “Fast” mode.

The setting range for the Horn Rotor is 0.2 to 5.0sec., and that for the Bass Rotor is 0.5 to 12.5sec.

10 BRAKE TIME - HORN (L)**17 BRAKE TIME - BASS (L)**

Sets the time for the Rotors to come to a complete “Stop” when switching from “Fast” mode.

The setting range for the Horn Rotor is 0.2 to 5.0sec., and the Bass Rotor is 0.5 to 12.5sec.

11 HORN CHARACTER (L)

Sets the tone of the Horn Rotor.

“FLAT” has no boost or cut in frequencies, and the “MID” or “DEEP” have “peaks” in various tonal ranges, to mimic the particular characteristics of the horns.

18 MIC - ANGLE (L)

The ANGLE and DISTANCE recreates the effect of two microphones.

The ANGLE sets the distance between the two virtual microphones.

The setting range is 0 to 180°. It is monaural at 0°, or both microphone placed in the center. Each higher number has effect of moving the microphones further apart from each other, resulting in greater stereo separation.

19 MIC - DISTANCE (L)

Sets the effect of setting the microphones at different distances from a Leslie Speaker cabinet, since distance has an effect on how the Leslie Speaker reproduces through a sound system.

The setting range is 0.3 to 2.7m (metric measurements). Setting the range “further away” will result in a less intense sound.

NOTE: After editing, you must record your changes to save them (Procedure following).

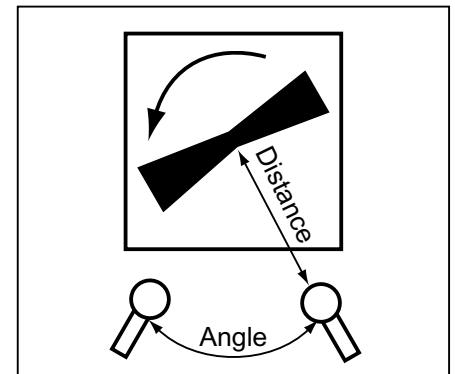
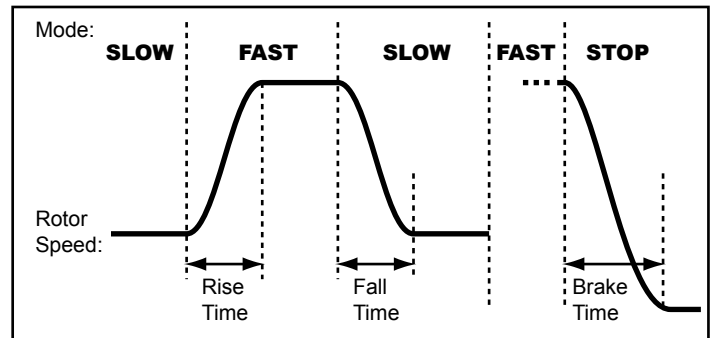

◆ EXTERNAL LESLIE SPEAKER

20 LESLIE CHANNELS

Sets the channel for the Leslie speaker connected to the LESLIE 11-PIN socket.

1ch: For connecting a 1 channel Leslie cabinet such as the 122XB, 3300/W (non-expansion). The Drawbar and the Percussion sounds are output only from the rotary channel, the other voices are from the LINE OUT jack.

3ch: This is for connecting a 3 channel Leslie cabinet such as the 2101/mk2. The Drawbar and the Percussion sounds are output from the rotary channel, the Extra Voices and bypassed Drawbar and Percussion sounds are from the stationary channel of the Main and Aux.

NOTE: This is a system parameter. It is recorded upon setting, and is common with all Patches.

RECORD THE CABINET

Record the Leslie Parameter (#2 to #19 on the previous page) to the Cabinet Numbers and use them selecting at the Patches.

1 ENTER THE NAME



Enter the name to the Cabinet as desired.

2 PRESS THE [RECORD]

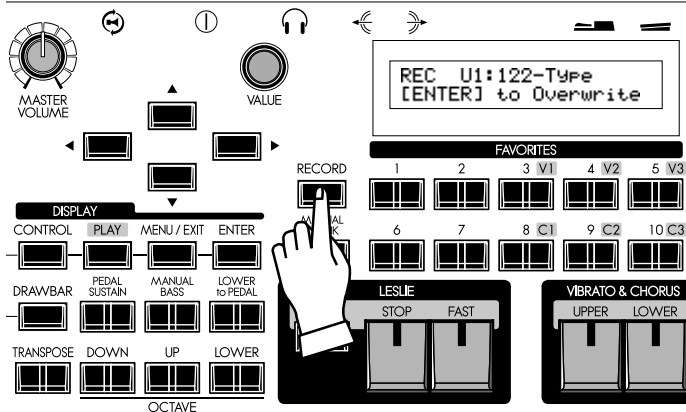

Press the [RECORD] button in the Leslie Parameter setting mode (#2 to #19).

A prompt will appear in the display allowing you to select the Cabinet you want to record.

3 SELECT THE NUMBER TO RECORD

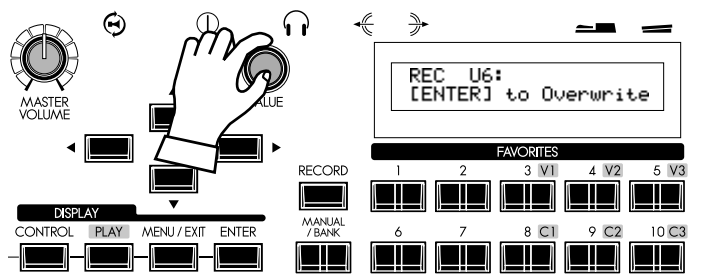

Select the Cabinet Number to record with the [VALUE] knob.

4 PRESS [ENTER] TO DECIDE

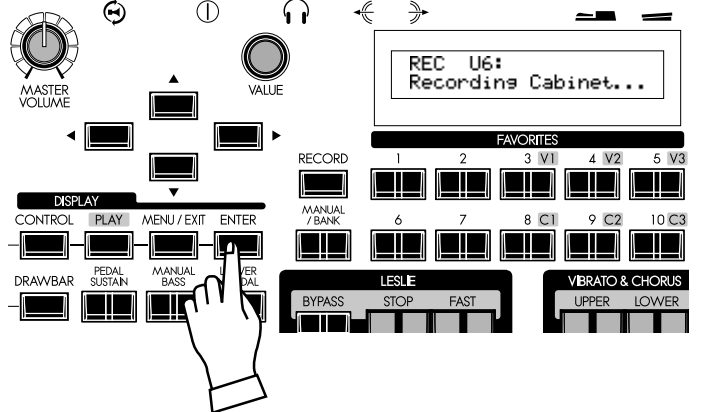

Press [ENTER] to recording the Cabinet.

The display will show the above message during the treatment.

NOTE: If you don't wish to record, touch the [MENU/EXIT] button.

In this mode, you select or edit the characteristics of each Tone Wheel set to be used on the manual keyboards.

To locate this mode:



See “Function mode” (P. 66) for operation details.

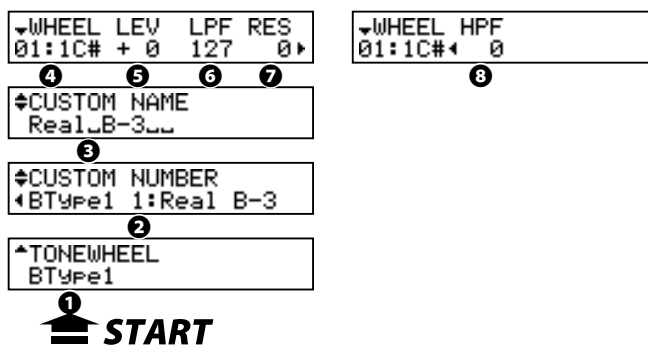

1 TONE WHEEL SET

This is for selecting the virtual Tone Wheel set of which “BType1”, “BType2” and “Mellow” are the Organ Types.

Also, the temporary (= the present setting) automatically switches to the selected virtual Tone Wheel set just selected now.

2 CUSTOM NUMBER

This is for selecting the “CUSTOM NUMBER” to use or compile. The “*” will be displayed when the virtual Tone Wheel Parameters are changed from this Custom Number.

NOTE: This parameter is a Patch Parameter. It is recorded into each individual Patch.

3 CUSTOM NAME

Allows you to name the Custom Tone Wheel using up to 10 character.

Move the cursor using the [◀] [▶] buttons and choose the letters using the [VALUE] knob.

The available characters include: Punctuation Marks (space - . ’ &), Numeric Characters (0 - 9), Upper-case Letters (“A - Z”), and Lower-case Letters (“a - z”).

The name set here, as well as the Tone Wheel Parameters below, will be deleted, if you do not perform the recording operation as explained on the next paragraph.

4 WHEEL NUMBER

Select the Number of the Wheel you want to regulate.

To select the Wheel Number, select the [VALUE] knob here, or slightly move the footage of the Drawbar while pressing the key you want to regulate (see the illustration on the right).

When the Wheel Number is selected, each parameter for the wheel (#5, #6, #7, #8) is displayed.

NOTE: Set the [OCTAVE] and [TRANPOSE] at “0” for select the correct wheel number.

tips INITIAL VALUE OF THE CUSTOM NUMBER

The typical settings are saved to the Number 1 - 3 (or 4), as the initial value.

For example, to the BType1, “Real B-3” simulating the well-preserved B-3/C-3 and “80’s Clean” with less noise, rough sound “Noisy”, and “Noisy 60” with louder leakage noise is stored.

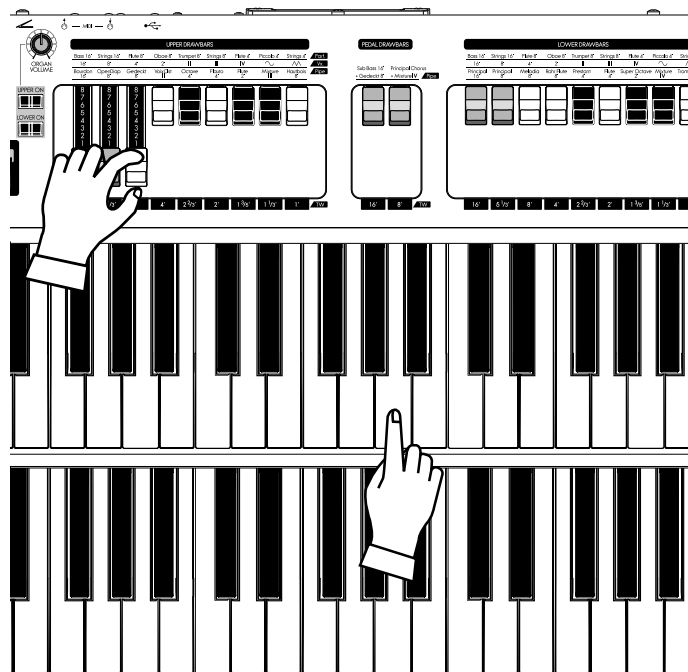

How to select the WHEEL NUMBER

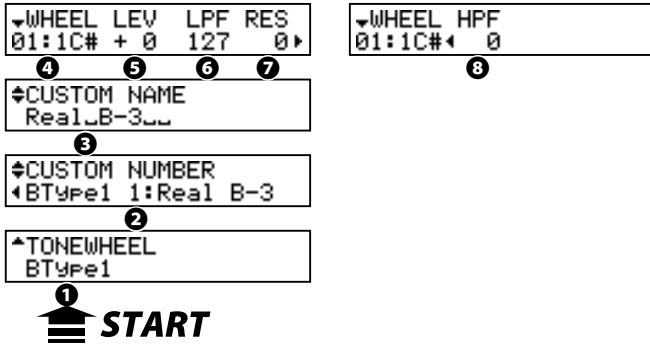

5 LEVEL

This is for setting the volume of a virtual wheel.
The setting range is -20 to +2dB. If you increase the value, it gets louder.

6 CUT OFF FREQUENCY - LPF

This is for setting the FREQUENCY to cut the TREBLE of a virtual wheel.
If you increase the value, a leakage noise is heard besides the original Tone Wheel pitch.
If you decrease the value, the sound gets sweet and mild, as the treble is cut off.
The setting range is 0 - 127.

NOTE: If you decrease the value too low below the fundamental Tone Wheel pitch, the wheel volume will be reduced.

7 RESONANCE - LPF

This setting boosts or reduces the level of the Cut Off Frequency - LPF (#6).
The setting range is 0 - 127. The higher value boosts treble, and lower values cut treble smoothly.

8 CUT OFF FREQUENCY - HPF

This is for setting the FREQUENCY to cut the BASS of this wheel.
If you decrease the value, a motor hum (= noise) is heard besides the original virtual Tone Wheel sound.
The setting range is 0 - 127.

NOTE: If you increase the value too high above the original Tone Wheel pitch, the sound will get "Thin".

NOTE: The parameters 3 - 8 are the virtual Tone Wheel Parameters. If you perform the recording operation of the next page, it works in common with the same virtual Tone Wheel set of each Patch.

NOTE: After editing, you must record your changes to save them (Procedure following).

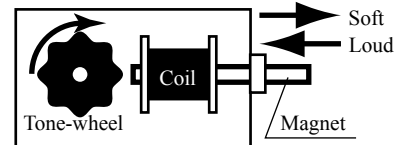

Concept of the LEVEL ADJUSTMENT

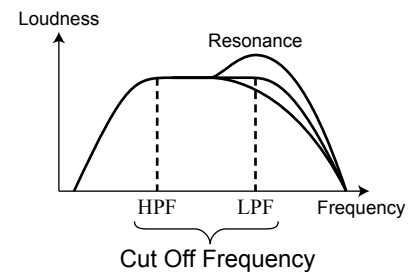

tips LEAKAGE NOISE

In the vintage electro-mechanical Hammond organs, sometimes the signal from adjacent Tone Wheels would be picked up (or "leaked") along with the current Tone Wheel in play. This "hash" noise, another Hammond anomaly originally considered to be a defect grew to be an integral part of the Hammond sound.

"Mellow" does not include the Leakage Noise.

tips DISTORTION

If you raise the Level and Resonance values too much, it changes the gain in the sound engine and may sometimes cause distortion, i.e. unpleasant noise.

In such a case, please lower these values.

Record the CUSTOM virtual Tone Wheels

The Tone Wheel Parameters (= 3 - 8 of the previous paragraph) are for determining the Custom Number for recording. The Custom Number is selected and used, when you play.

① ENTER THE NAME



Enter the Custom Name if desired.

② PRESS THE [RECORD]

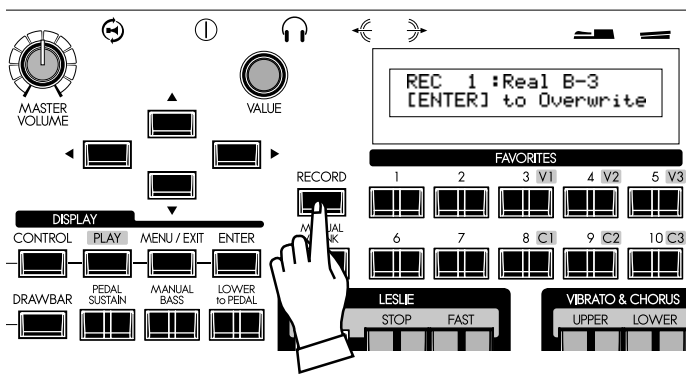

Touch the [RECORD] button in the setting mode of the Tone Wheel Parameters.

The mode for selecting the Custom Number to be recorded will be displayed.

③ SELECT THE NUMBER TO RECORD

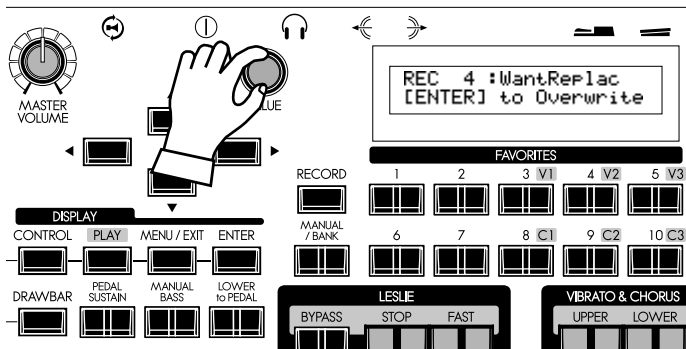

Select the Custom Number to be recorded using the [VALUE] knob.

④ PRESS [ENTER] TO DECIDE

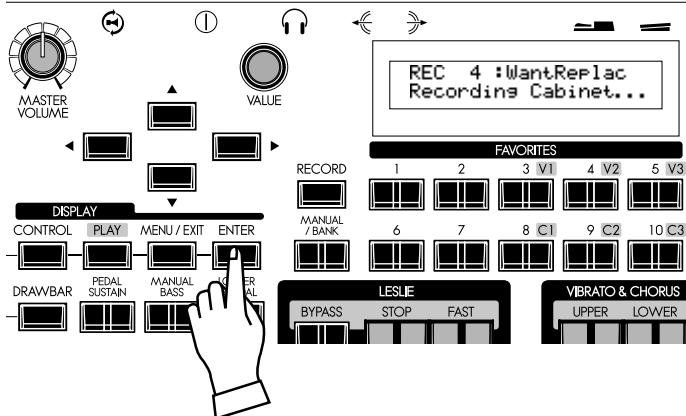

It will be recorded if you touch [ENTER] button.

The display will be as illustrated, while the recording is being written to memory.

NOTE: If you do not want to record it, just touch the [MENU] button.

PIPE

In this mode, you edit the characteristics of each Pipe Stop.

To locate this mode:



See “Function mode” (P. 66) for operation details.

▼PEDAL 2 VOL DETN
Pc4+Mixt 120 + 2 ▶

▼PEDAL 2 CHIF CUTOFF
Pc4+Mixt◀MID + 0▶

▼PEDAL 2 DIR-PAN-IMG
Pc4+Mixt◀-C- ▶INV

... omitted ...

▲UPPER 1 VOL DETN
Bourdn16 96 - 3 ▶

▲UPPER 1 CHIF CUTOFF
Bourdn16◀SOFT + 0▶

▲UPPER 1 DIR-PAN-IMG
Bourdn16◀L20 ▶L-R

1

2

3

START

4

5

6

7

1 PIPE STOP

Select the Pipe Stop which you desire to edit using [▲],[▼] buttons, or move the Drawbar which corresponding the Pipe Stop.

There are 20 Pipe Stops which according to Drawbars from “Bourdon 16” to “Principal Chorus + Mixture IV” (P. 46).

2 VOLUME (Pi)

Adjusts the volume of the Pipe Stop. The setting range is 0 to 127.

3 DETUNE (Pi)

Detunes the pitch of Pipe Stop from accurate pitch by cents (1/100 of semitones). The setting range is -50 - 0 - +50.

4 CHIFF (Pi)

Sets the “Chiff” noise of beginning of notes.

OFF: No chiff.

SOFT: Soft chiff.

MID: Moderate amount of chiff.

LOUD: Maximum amount of chiff.

NOTE: The Reed Pipes (Hautbois 8’ and Trompette 8’) are not affected by this parameter.

5 CUT OFF FREQUENCY (Pi)

Adjusts the tone quality of the Pipe Stop.

The setting range is -64 to 0. At 0, the full range of sound will be heard. Decreasing this value will cause tone to become more mellow.

6 PAN - DIRECTION (Pi)

Adjusts the directionality of the Pipes in order to simulate chamber placement.

The setting range is L64 - C - R63 (Left - Center - Right).

tips DETUNE

The beating is heard by sounding detuned pitch on sounding accurate pitch.

Generally, they are effect works well if the lower-pitched Pipes are set a “-” value while higher-pitched Pipes are set a “+” value. However, it is strongly recommended that this effect be used sparingly in order to avoid an unpleasant “out-of-tune” effect.

7 PAN - IMAGING (Pi)

Sets the arrangement of the Pipes.

- FIX:** No panning or imaging - All notes sound uniformly.
- L-R:** Sounds Left to Right which according to the keys.

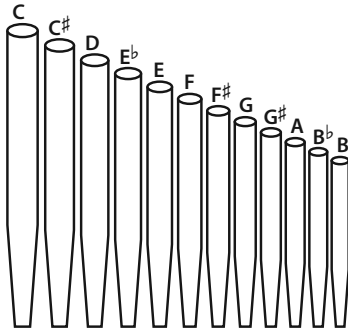

R-L: Sounds Right to Left which according to the keys.

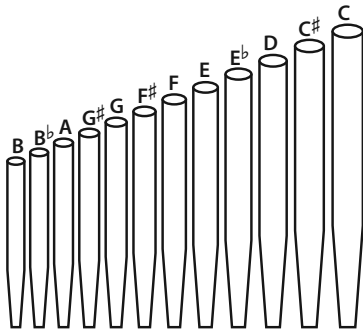

PYR: Like the PYRAMID, sounds center to sides which according to the keys.

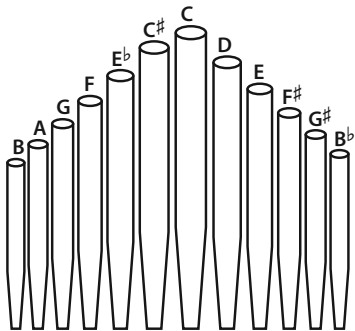

INV: Like the INVERTED pyramid, sounds sides to center which according to the keys.

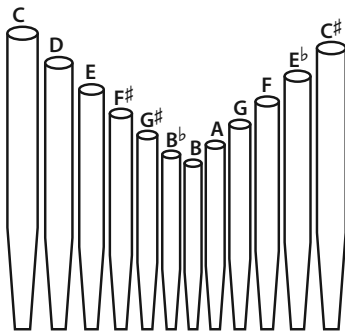

tips PAN AND OUTPUT

The Pipe Stops are extended left to right. Because of this, you may notice that some notes will sound louder than other if only one LINE OUT is used. To remedy this, set the "Audio Mode - Output" (P. 102 #1) at "MONO". This will disable Note Panning and all notes will sound at equal volume.

NOTE: The parameters of these modes (Pi) are Pipe parameters. They are recorded when they are set, and are common for each Patch.

OD / EFF (Overdrive / Effects)

In this mode, Overdrive and the Multi-Effects are adjusted.

The Organ and Extra Voice Sections have their own independent Overdrive and Multi-Effects section.

To locate this mode:



or, keep pressing the [OVERDRIVE], [EFFECT ON] buttons for a few seconds.
See "Function mode" (P. 66) for operation details.

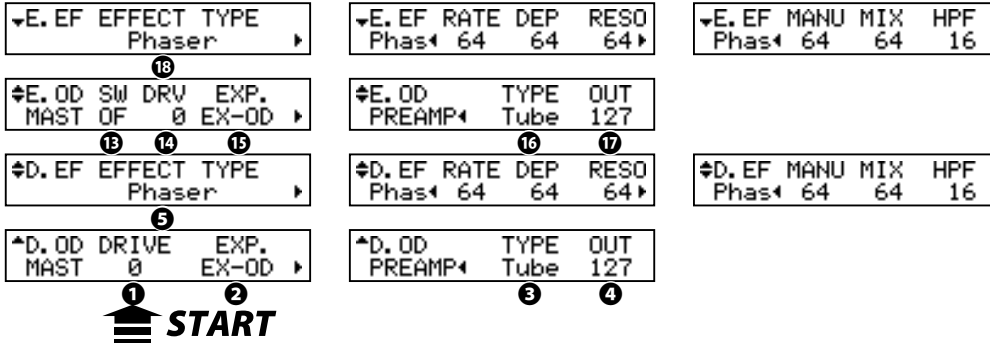

◆ ORGAN SECTION EFFECTS

OVERDRIVE

1 OVERDRIVE - DRIVE

Adjusts the overall amount of the Overdrive. The higher the value, more distortion is obtained. It is linked with the [DRAWBARS OVERDRIVE AMOUNT] knob on the top panel.

2 OVERDRIVE - EXPRESSION

Sets response of Overdrive to an Expression Pedal.

- EX-OD:** Overdrive effect increases/decreases along with volume.
- OD-EX:** Overdrive effect remains constant, Expression Pedal increases/decreases volume.
- OD ONLY:** Volume remains constant, Expression Pedal increases/decreases the amount of Overdrive.
- INPUT:** Expression Pedal attenuates INPUT level to Overdrive effect. Lesser Volume control.

3 OVERDRIVE - PREAMP

Sets the characteristic of the Overdrive.

- Tube:** Replicates the overdrive of a tube-driven amp.
- Stomp:** Replicates the stomp box.
- Clip:** Accurate hard clip.
- EPamp:** Replicates the pre-amplifier of an electric piano.

4 OVERDRIVE - OUTPUT LEVEL

Allows you to balance the Overdrive level with the input level if the two are different.
The setting range is 0 to 127.

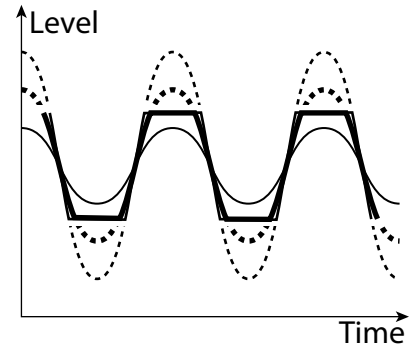

MULTI-EFFECTS

5 EFFECT TYPE

Selects the Multi-Effect type. The following effects are built in the SKX.

Tremolo, Auto Pan, Wah-Wah, Ring Mod., Phaser, Flanger, Chorus, Delay

The parameters for the Multi-Effects are different type by type. The explanation about the types follows:

Tremolo

The Tremolo modulates the volume at a set cycle.

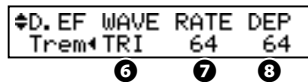

6 TREMOLO - WAVEFORM

Sets which waveform is used to modulate the volume.

- Tri:** Triangle wave. The volume changes smoothly.
- Sqr:** Square wave. The volume suddenly rises and falls.
- Saw:** Sawtooth wave. Repeated decaying sound is obtained.
- S&H:** Sample & hold. The volume changes randomly.
- DSqr:** Dull square wave like the old electric piano effect.

7 TREMOLO - RATE

Adjusts the speed of the tremolo cycle.

The setting range is 0 to 127. The higher the value rises, the faster the cycle.

This is linked with the [EFFECT AMOUNT] knob on the top panel.

8 TREMOLO - DEPTH

Adjusts the depth of the tremolo effect.

The setting range is 0 to 127. At 0 the volume does not modulate. The higher the value, the deeper becomes the effect. At 127, the sound will alternate between "no sound" and maximum volume.

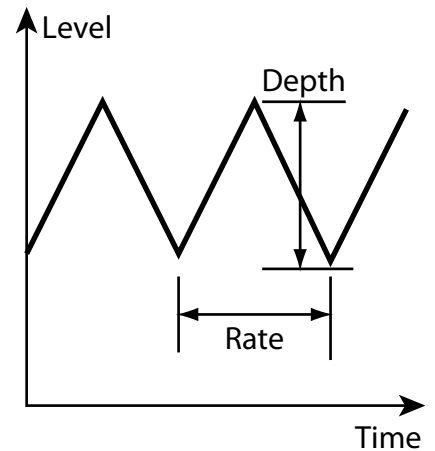

Auto Pan

Auto Pan applies adjustable modulation to the stereo field.

This is not applicable if a monophonic (one channel) amp is used, or when the Leslie effect is used.

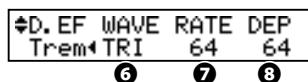
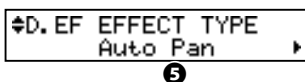

6 AUTO PAN - WAVEFORM

Sets which waveform to modulate the direction.

- Tri:** Triangle wave. The direction smoothly changes.
- Sqr:** Square wave. The direction suddenly moves to the left, and suddenly moves to the right.
- Saw:** Sawtooth waveform. The direction repeatedly moves from left to right.
- S&H:** Sample & hold. The direction changes randomly.
- DSqr:** Dull square wave like the old electric piano effect (recommended).

7 AUTO PAN - RATE

Adjusts the speed of the modulation.

The setting range is 0 to 127. The higher the value, the faster the modulation. It is linked with the [EFFECT AMOUNT] on the top panel.

8 AUTO PAN DEPTH

Adjusts the depth of the cycle.

The setting range is 0 to 127. At 0, there is no direction modulation. The higher the value, the deeper the effect. At 127 you can give a perfect left/right repetition.

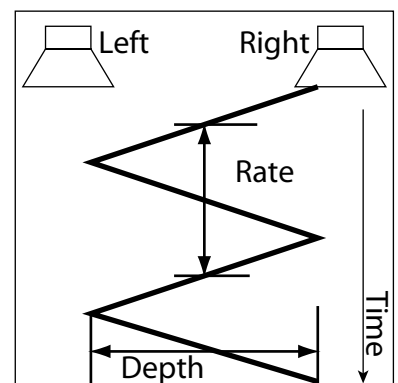

NOTE: All the parameters in these modes are Patch Parameters. They are recorded into the Patch.

Wah-Wah

Wah-Wah imposes a “speech-like” dynamic to the sound.

↔D. EF EFFECT TYPE	▶
Wah-Wah	
5	

↔D. EF SRC	SENS	RES	▶
Wah ◀LFO	64	64	
6	7	8	

↔D. EF WAVE	RATE	FREQ	▶
Wah ◀Tri	64	64	
9	10	11	

6 Wah-Wah - SOURCE

Selects the source of the Wah-Wah control.

MAN: Uses the FREQ parameters, i.e. the [EFFECT AMOUNT] knob.

EXP: Uses the Expression Pedal as a “Wah Wah pedal”.

LFO: Auto-Wah using the built-in ‘LFO - Low Frequency Oscillator’.

7 Wah-Wah - SENSITIVITY

Sets the sensitivity to change the Wah effect of the LFO or Expression Pedal.

It is linked with the [EFFECT AMOUNT] knob on the top panel when the SOURCE (6) is set at EXP.

The setting range is 0 to 127. The dynamic response increases as the value rises.

8 Wah-Wah RESONANCE

Boosts the cut-off frequency range of the Low-pass Filter and gives a more pronounced “Wah” effect.

The setting range is 0 to 127. The resonance increases as the value rises.

9 Wah-Wah - WAVEFORM

When the SOURCE (6) is set at LFO, the LFO wave form is set.

Tri: Triangle wave. The sound smoothly varies.

Sqr: Square wave. The filter suddenly opens and suddenly closes.

Saw: Saw-tooth wave. Repeated changes in the sound are obtained.

S&H: Sample & Hold. Random sound changes are obtained.

10 Wah-Wah - RATE

When the SOURCE (6) is set at LFO, the cycle speed is adjusted. It is linked with the [EFFECT AMOUNT] knob on the top panel when the SOURCE (5) is set at LFO.

The setting range is 0 to 127. The cycle becomes faster as the value increases.

11 Wah-Wah - FREQUENCY

Adjusts the central frequency. It is linked with the [EFFECT AMOUNT] knob on the top panel when the SOURCE (6) is set at MAN.

The setting range is 0 to 127. The frequency becomes higher as the value is increased.

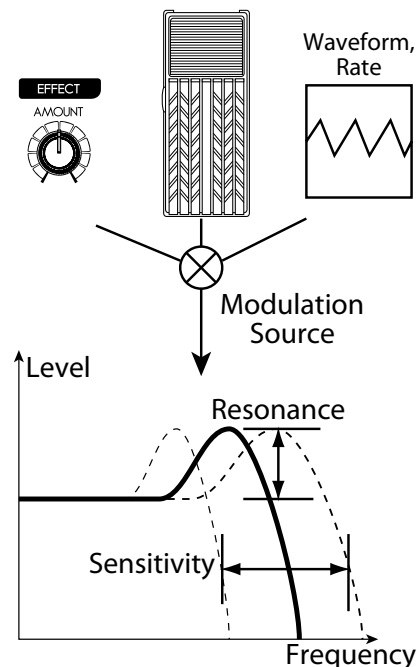

Ring Mod.

The Ring Modulator creates complex, metallic-like sounds by taking the sum and difference of the fundamental tone and a second “ring” frequency.

◀D. EF EFFECT TYPE	▶
Ring Mod.	
5	

◀D. EF SRC	FREQ	MIX	▶
RMod	MAN	64	64
6 7 8			

◀D. EF WAVE	RATE	DEP	▶
RMod	Tri	64	64
9 10 11			

6 RING MODULATOR - SOURCE

Selects which to use to modulate the ring frequency.

MAN: Uses the following FREQ parameter, i. e. the [EFFECT AMOUNT] knob.

EXP: Modulates the ring frequency with the Expression Pedal.

LFO: Allows a cyclical modulation effect using the built-in LFO-Low Frequency Oscillator.

NOTE: The ring frequency changes by the note, i. d. the UPPER Part performance (or the performance of the allocated part if in the Extra Voices).

7 RING MODULATOR - FREQUENCY

Adjusts the central ring frequency. It is linked with the [EFFECT AMOUNT] knob on the top panel when the SOURCE (6) is set at MAN, EXP and NOTE.

The setting range is 0 to 127. The frequency becomes higher as the value increases.

8 RING MODULATOR - MIX

Adjusts the volume balance between the fundamental and effect sounds.

The setting range is 0 to 127. At 0, only the fundamental sound is heard. As the value is raised, the more effect is added. At 127, only the effect comes out.

9 RING MODULATOR - WAVEFORM

Selects the LFO waveform when the SOURCE (6) is set at LFO.

Tri: Triangle wave. The ring frequency number smoothly varies.

Sqr: Square wave. The ring sound suddenly changes to treble and also suddenly to bass.

Saw: Sawtooth wave. The ring sound repeatedly drops from treble to bass.

S&H: Sample & hold wave. The ring frequency changes randomly.

10 RING MODULATOR - RATE

Adjusts the rate of the LFO when SOURCE (6) is set at LFO.

It is linked with the [EFFECT AMOUNT] knob on the top panel when the SOURCE (6) is set at LFO.

The setting range is 0 to 127. The cycle becomes faster as the value increases.

11 RING MODULATOR - DEPTH

Adjusts the depth of the frequency change when the source is set at LFO or EXP.

The setting range is 0 to 127. The ring frequency changes wider as the value increases.

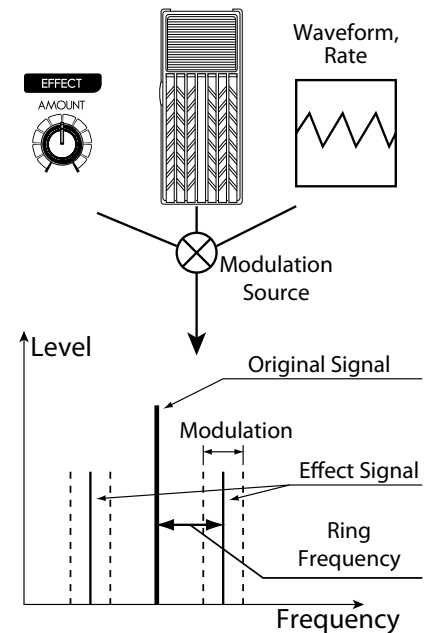

Phaser

This creates a sound with a shifting phase, adding a twisting effect to the sound.

↔D. EF EFFECT TYPE Phaser ▶	↔E. EF RATE DEP RESO Phas◀ 64 64 64▶	↔D. EF MANU MIX HPF Phas◀ 64 64 16
5	6 7 8	9 10 11

6 PHASER - RATE

Adjusts the frequency speed. It is linked with the [EFFECT AMOUNT] knob. The setting range is 0 to 127. The cycle becomes faster as the value increases.

7 PHASER - DEPTH

Adjusts the depth of modulation. The setting range is 0 to 127. The modulation becomes deeper as the value increases.

8 PHASER - RESONANCE

Adjusts the resonance (feed-back) amount. The setting range is 0 to 127. The resonance becomes greater as the value increases. At higher values, the sound is modulated beyond normal recognition.

9 PHASER - MANUAL

Sets the middle frequency of the phase effect. The setting range is 0 to 127. The frequency becomes higher as the value increases.

10 PHASER - MIX

Adjusts the volume balance between the “dry” and the effect sound. The setting range is 0 to 127. At 0, only “dry” is heard. The effect level becomes greater as the value increases. At 127 the ratio between the “dry” and the effect sounds becomes 1:1.

11 PHASER - HPF

Controls the frequency range of the effect. The setting range is 0 to 127. At 0 the effect is added to all frequencies. The effect is added to the higher frequencies as the value increases.

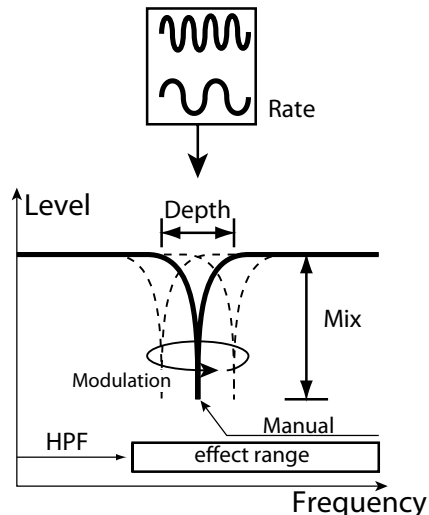

Flanger

This is the sweeping “Jet Airplane” sound adjustable from a mild shimmer to a deep “swoosh”.

↔D. EF EFFECT TYPE Flanger ▶	↔D. EF RATE DEP RESO Flng▶ 64 64 0▶	↔D. EF DLAY MIX HPF Flng▶ 0 64 64
5	6 7 8	9 10 11

6 FLANGER - RATE

Adjusts the modulation speed. It is linked with the [EFFECT AMOUNT] knob on the top panel.

The setting range is 0 to 127. The cycle becomes faster as the value increases.

7 FLANGER - DEPTH

Adjusts the depth of modulation.

The setting range is 0 to 127. The modulation becomes deeper as the value increases.

8 FLANGER - RESONANCE

Adjusts the amount of resonance (feed-back).

The setting range is 0 to 127. The resonance becomes greater as the value increases. At higher values, the sound is modulated beyond normal recognition.

9 FLANGER - DELAY

Controls the delay of the effect sound.

The setting range is 0 to 127. The delay increases as the value is increased.

10 FLANGER - MIX

Adjusts the volume balance between the “dry” and the effect sound.

The setting range is 0 to 127. At 0, only the “dry” is heard. The effect level becomes greater as the value is increased. At 127 the ratio between the “dry” and the effect sounds becomes 1:1.

11 FLANGER - HPF

Controls the frequency range of the effect.

The setting range is 0 to 127. At 0 the effect is added to all frequencies. The effect is added to the higher frequencies as the value increases.

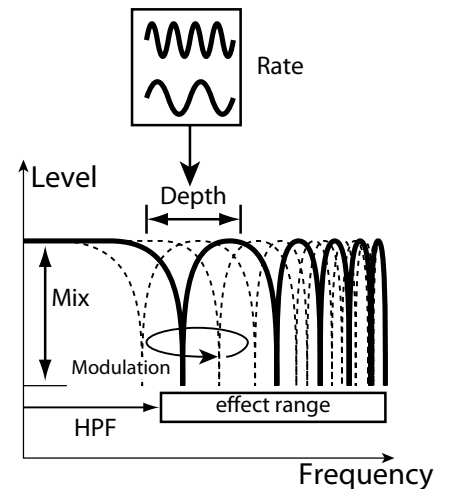

Chorus

This “Chorus” is NOT the same as Hammond’s proprietary “Chorus-Vibrato”. This effect is the familiar Chorus as heard widely on electric pianos, guitars, etc.

↔D. EF EFFECT TYPE Chorus ▶	↔D. EF RATE DEP RESO Cho ◀ 64 64 0 ▶	↔D. EF DLY MIX HPF PH Cho ◀ 0 64 64 3 ▶
5	6 7 8	9 10 11 12

6 CHORUS - RATE

Adjusts the speed of the cycle of the rising and falling effect pitch. It is linked with the [EFFECT AMOUNT] on the top panel.

The setting rate is 0 to 127. The cycle becomes faster as the value increases.

7 CHORUS - DEPTH

Adjusts the depth of modulation.

The setting range is 0 to 127. The modulation becomes deeper as the value increases.

8 CHORUS - RESONANCE

Adjusts the amount of resonance (feed-back).

The setting range is 0 to 127. The resonance becomes greater as the value increases. At higher values, the sound is modulated beyond normal recognition.

9 CHORUS - DELAY

Controls the delay of the effect sound.

The setting range is 0 to 127. The delay becomes greater as the value increases.

10 CHORUS - MIX

Adjusts the volume balance between the “dry” and the effect sound.

The setting range is 0 to 127. At 0, only the “dry” is heard. The effect level becomes greater as the value increases. At 127 the ratio between the “dry” and the effect sounds becomes 1:1.

11 CHORUS - HPF

Controls the frequency range of the effect.

The setting range is 0 to 127. At 0, the effect is added to all frequencies. The effect is added to the higher frequencies as the value increases.

12 CHORUS - PHASE

Selects the type of the chorus effect available:

“2” (normal) or “3” (rich) phase effect type.

NOTE: There is no phase parameter on the Organ section. And it is fixed at “2”.

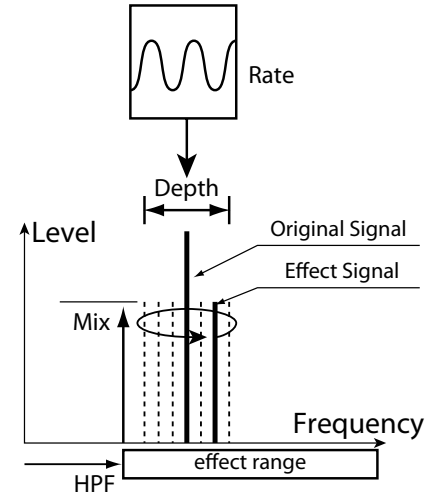

Delay

This is for adding echo effects.

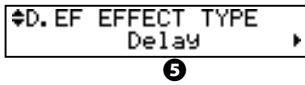

5

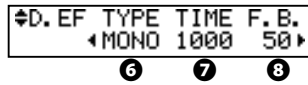

6

7

8

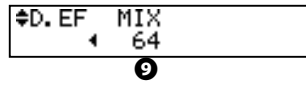

9

6 DELAY - TYPE

Select the type of delay here.

MONO:

A simply delayed sound.

RtoL, LtoR:

The delay is alternated in the stereo field. At RtoL the delayed sound comes from the right, and at LtoR from the left. Your results may vary when used in a mono idiom, or through a Leslie Speaker.

7 DELAY - TIME

Adjusts the delay time. It is linked with the [EFFECT AMOUNT] on the top panel.

The setting range is 10 to 1000 ms.

8 DELAY - FEED-BACK

Sets the repetition amount of the effect sound.

The setting range is 0 to 127. The repetition becomes greater as the value is increased.

9 DELAY - MIX

Adjusts the volume balance between the “dry” and the effect sound.

The setting range is 0 to 127. At 0, only the “dry” is heard. The effect level becomes greater as the value is increased. At 64 the ratio between the “dry” and the effect sounds becomes 1:1. At 127 only the effect sound is heard.

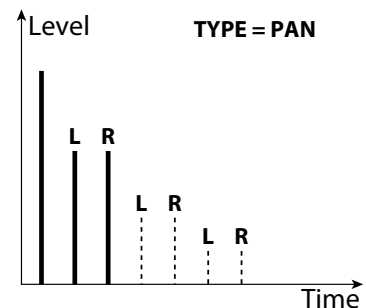
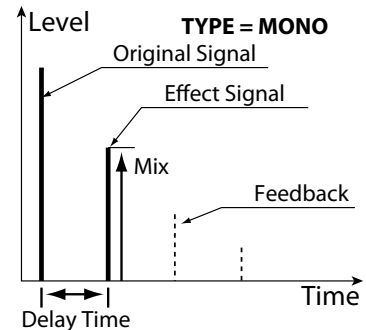

◆ EFFECTS FOR THE EXTRA VOICE SECTION

OVERDRIVE

13 OVERDRIVE - SWITCH

Turns the Overdrive effect of Extra Voice section “ON/OFF”.

NOTE: While this parameter is “ON”, the stereo sound such as “Stereo Grand” etc. becomes monaural.

14 OVERDRIVE - DRIVE

Controls the distortion amount. The distortion becomes greater as the value is increased.

There is no knob linked with this effect, different from the Organ section, so the setting is possible only in this mode.

15 OVERDRIVE - EXPRESSION

16 OVERDRIVE - PREAMP

17 OVERDRIVE - OUTPUT LEVEL

The functions of these parameters are the same as those of the Organ section.

MULTI-EFFECTS

18 EFFECT TYPE

and the other effect parameters

The functions of these parameters are the same as those of the Organ section.

tips OVERDRIVE AND VOLUME

The Overdrive effect is realized with amplifies the audio signal. To get the effect in full, raise the [EXTRA VOICE VOLUME] as possible.

If the sound is too loud by using overdrive effect, please let down the OUTPUT LEVEL of the Overdrive.

NOTE: All the parameters in these modes are Patch Parameters. They are recorded into the Patch.

EQUALIZ (Equalizer)

In this mode, you adjust the settings for the Equalizer.

An Equalizer is used to adjust the tonal quality. The SKX's built-in Equalizer consists of 3 bands and a recreation of the unique "tone" control that was part of the vintage B-3/C-3. The Bass and Treble bands are handled by "shelf" equalizers, and the Mid band is handled by parametric control.

To locate this mode:

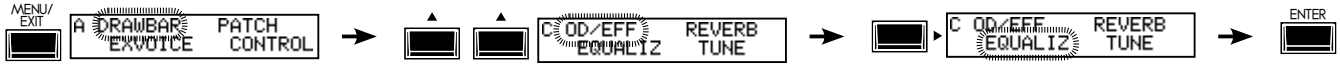

See "Function mode" (P. 66) for operation details.

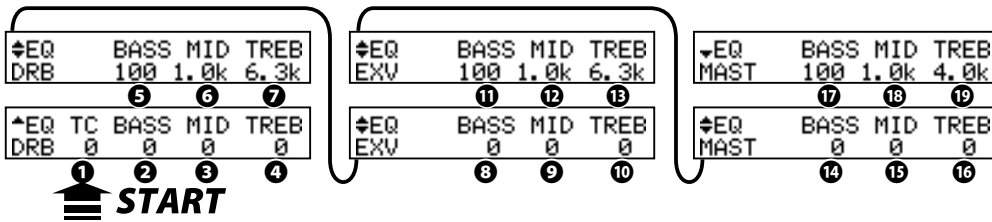

◆ ORGAN SECTION

1 TONE CONTROL (P)

This is a simulated original B-3/C-3 TONE CONTROL. Its response is unique, but its basic response is to gently cut the overall treble above 200Hz.

The setting range is -9 to +9, and it becomes neutral when set at "0". "-1" corresponds to the maximum of the original B-3/C-3 tone control, "-5", the middle, "-9", the minimum. The tone control found on the original B-3/C-3, was only available at "minus" settings, but here you are able to "plus" the settings as well.

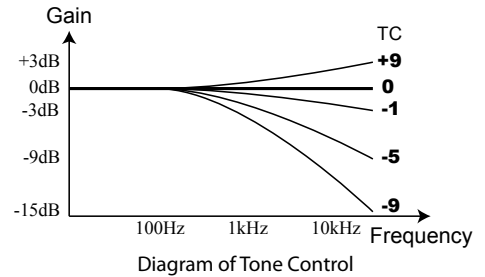

◆ ORGAN SECTION, EXTRA VOICE SECTION, MASTER

2 3 14 GAIN - BASS (P) (P) (G)

3 9 15 GAIN - MIDDLE (P) (P) (G)

4 10 16 GAIN - TREBLE (P) (P) (G)

Adjusts the Boost/Cut of Bass, Mid-range and Treble respectively.

The setting range is -9 to +9. It is flat at 0.

5 11 17 FREQUENCY - BASS (P) (P) (G)

6 12 18 FREQUENCY - MIDDLE (P) (P) (G)

7 13 19 FREQUENCY - TREBLE (P) (P) (G)

Adjusts the center frequency (MIDDLE) / turnover frequency (BASS, TREBLE) to be attenuated.

The setting range is 20Hz - 200Hz for BASS, 250Hz - 3.1kHz for MIDDLE, 4.0kHz - 8.0kHz for TREBLE.

NOTE: The sound may distort if gains are raised too high. Adjust accordingly.

NOTE: The parameter with (P) indicated is a Patch parameter, and is recorded to each Patch. (G) indicates "Global parameter", which is recorded upon being set, and is common with each Patch.

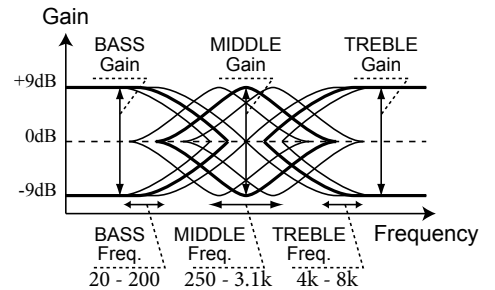

tips TURNOVER FREQUENCY

The MIDDLE of this equalizer controls a point of frequency. This is called center frequency. The BASS (or TREBLE) controls lower (or higher) than specified frequency. This is called turnover frequency.

tips PATCH PARAMETERS

The equalizer for Organ section and Extra Voice sections are designed to be a Patch parameter (P) to be actively utilized as a part of sound making parameter.

Use the Master Equalizer for tonal compensation to match the performance stage (G).

In this mode, you set the Reverb effect.

Reverb is common with the Organ and Extra Voice sections, the single reverb control section affects both.

To locate this mode:

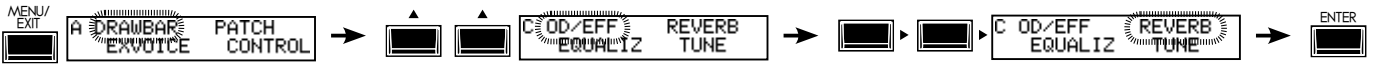

or, keep pressing the [REVERB ON] button for a few seconds.
See “Function mode” (P. 66) for operation details.

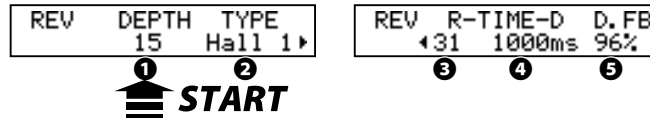

1 DEPTH

This sets the depth (volume) of the Reverb Effect.

The setting range is 0 to 127. This parameter is linked with the [REVERB DEPTH] knob on the top panel.

2 TYPE

This sets the types of Reverb Effect.

- Room 1:** Small room
- Room 2:** Large room
- Live:** Ambient room
- Hall 1:** Large Hall
- Hall 2:** Small Hall
- Church:** Church
- Plate:** Iron-plate Reverb
- Spring:** Spring Reverb
- Delay:** Delay
- PanDly:** Panning Delay
- RevDly:** Reverb + Delay

3 REVERB TIME

When the Type (#2) is set at Room 1 to Spring, The decay of the Reverb is attenuated.

The setting range is 0 to 127. The decay becomes greater as the value is increased.

4 DELAY TIME

When the Type (#2) is set at Delay, PanDly, RevDly, this sets the delay time.

The setting range is 4.7 to 2000ms. The delay becomes longer as the number value is increased.

NOTE: You can set the delay time with the foot switch. (P. 76 #2)

5 DELAY FEEDBACK

When the Type (#2) is at Delay, PanDly, RevDly, it sets the amount of Feedback (How many times the sound repeats.)

The setting range is 0 to 96%. The repetition becomes greater as the value is increased.

NOTE: Type (#2) is a micro-parameter. When you change the type, each reverb parameter (except #1) is automatically set to the recommend value.

NOTE: All the parameters in these modes are Patch Parameters. They are recorded into the Patch.

In this mode, the entire keyboard is tuned.

To locate this mode:

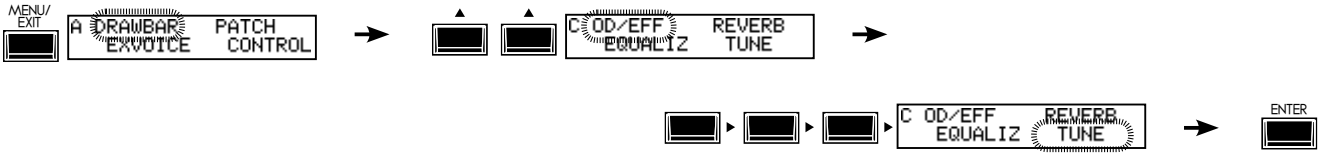

See "Function mode" (P. 66) for operation details.

TUNE MASTER
A=440



◆ MASTER TUNE

① MASTER TUNE

This is for tuning the entire keyboard.

The setting range is A = 430 to 450 Hz.

NOTE: The parameter of this mode is a Global parameter. It is recorded when it is set, and is common for each Patch.

In this mode, you can go back totally or partially to the factory default settings.

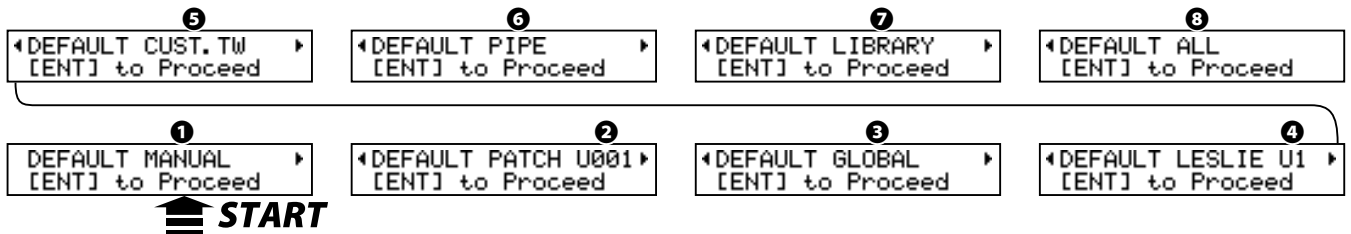
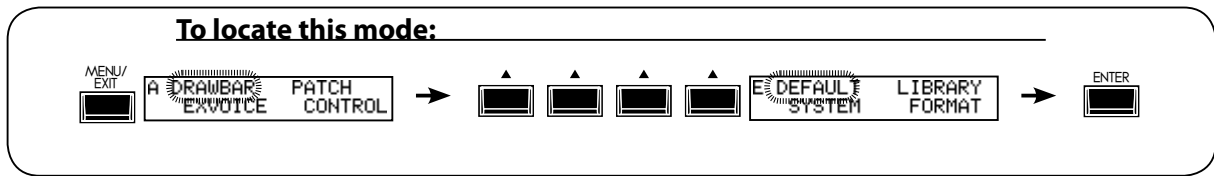

To initialize each parameter, select the parameter you want to initialize with the [◀][▶] button and press the [ENTER] button.

1 MANUAL

This is for initializing the contents of the [MANUAL] button.

Used to create a “clean slate” for new Patch settings.

2 PATCH

This is for initializing the User Patch contents (copy the contents of a Preset Patch into User Patch of the same number).

Select the Patch you want to initialize with the [VALUE] knob. The selecting range is U001 to U100 and ALL (All user Patches).

3 GLOBAL

This is for initializing the Global Parameters such as the Master Tune or assignment of the Foot Switch.

4 LESLIE

This is for initializing the contents of all internal Leslie cabinets. Select the cabinet you want to initialize with the [VALUE] knob. The selecting range is U1 to U8 and ALL (All User cabinets).

5 CUSTOM TONE-WHEELS

This is for initializing the contents of all custom Tone Wheels.

6 PIPE

This is for initializing the Pipe parameters.

7 LIBRARY

This is for deleting all the tone library contents and rewriting to the default contents.

8 ALL

This is for defaulting all parameters of the SKX.

If any unstable condition occurs on the SKX system, defaulting “all” will usually clear the problem.

NOTE: You can also totally initialize your keyboard by switching the power ON while pressing and holding the [RECORD] button.

SYSTEM

In this mode, set the auto power off, audio output mode, and the System information of the SKX is displayed.

To locate this mode:

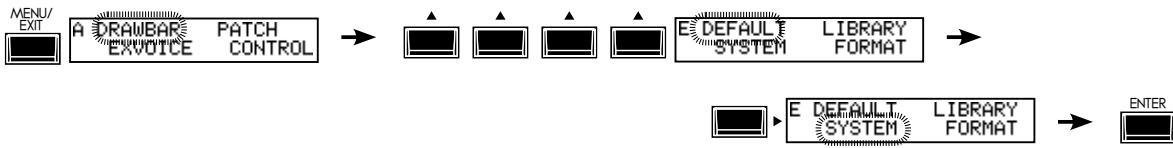

See "Function mode" (P. 66) for operation details.

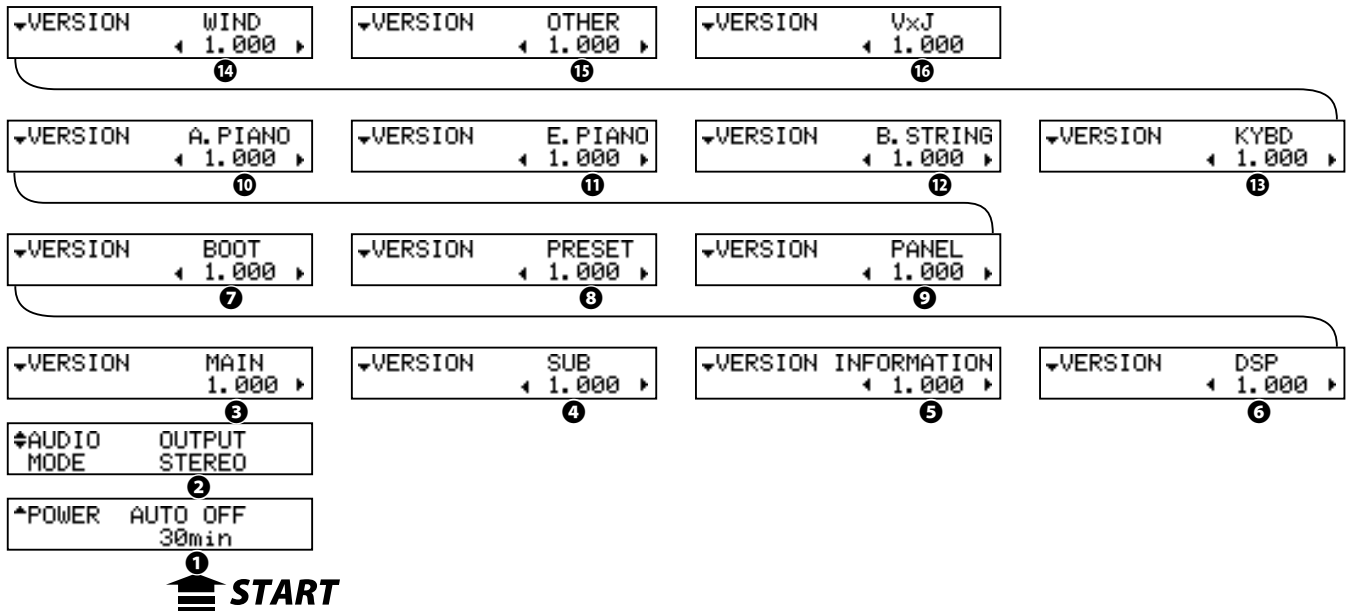

1 POWER - AUTO OFF

Sets whether power off after a certain time is elapsed since last operated.

30min

Powers off if the time is elapsed 30 minutes since last played/operated.

DISABLE

Disable auto off.

2 AUDIO MODE - OUTPUT

Sets the audio mode of output jacks.

STEREO

Use this if it is stereo connection. You can get the maximum stereophonic sound effects.

MONO

Use this if it is mono connection. Though it makes no stereophonic sound effects, it avoids "drop out" by sounding opposite channel.

3 VERSION - MAIN PROGRAM

4 VERSION - SUB-PROGRAM

5 VERSION - VOICE INFORMATION

6 VERSION - D. S. P.

7 VERSION - BOOTSTRAP PROGRAM

8 VERSION - FACTORY PRESET

9 VERSION - CONTROL PANEL

10 VERSION - EXV (A. Piano)

11 VERSION - EXV (E. Piano)

12 VERSION - EXV (B. String)

13 VERSION - EXV (Keyboard)

14 VERSION - EXV (Wind)

15 VERSION - EXV (Others)

16 VERSION - EXV (VxJ)

These are display only and not intended for System update use.

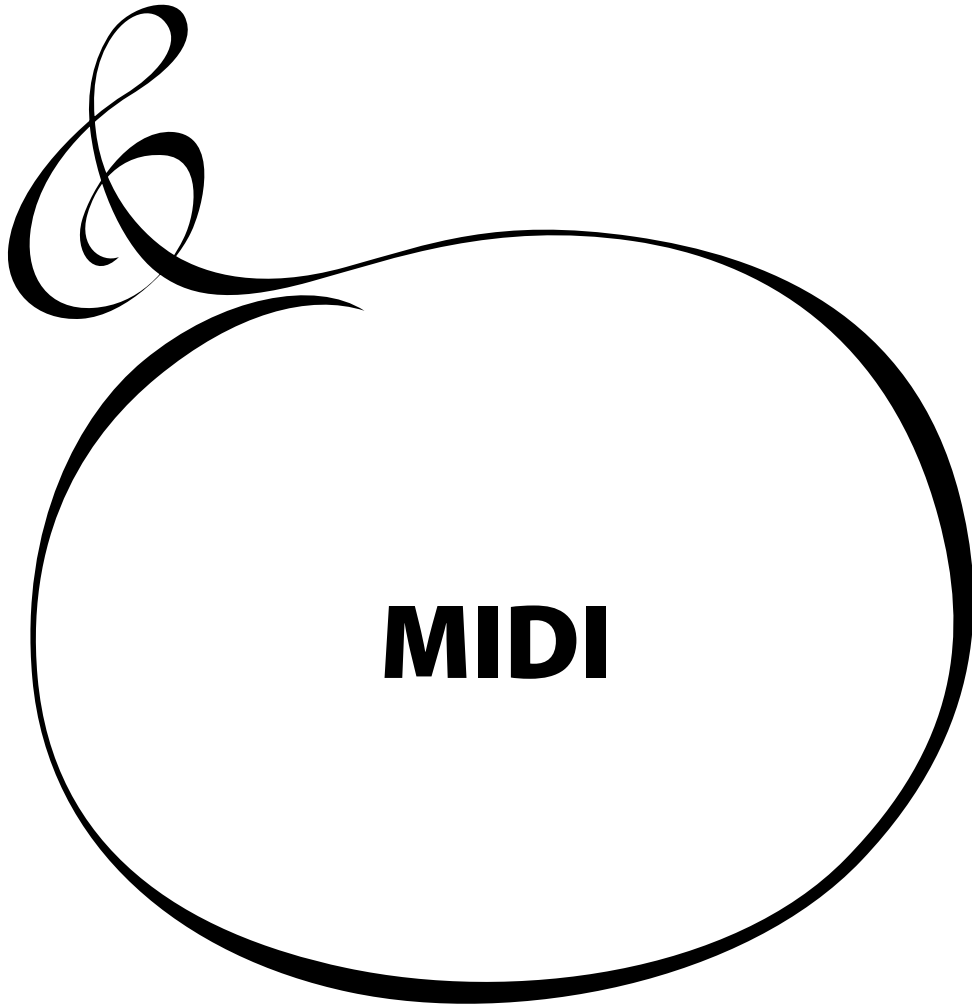

WHAT IS “MIDI”?

MIDI is an abbreviation of ‘Musical Instrument Digital Interface’.

MIDI is the musical instrument industry standard for exchanging performance information between electronic musical instruments and a sequencer, effects, lighting, and sound reinforcement gear, etc.

The MIDI standard allows instruments made by different manufacturers to effectively communicate with each other.

Many types of data can be transmitted and received, including all performance information, settings of parameters, and global commands.

MIDI JACKS ON THE SKX

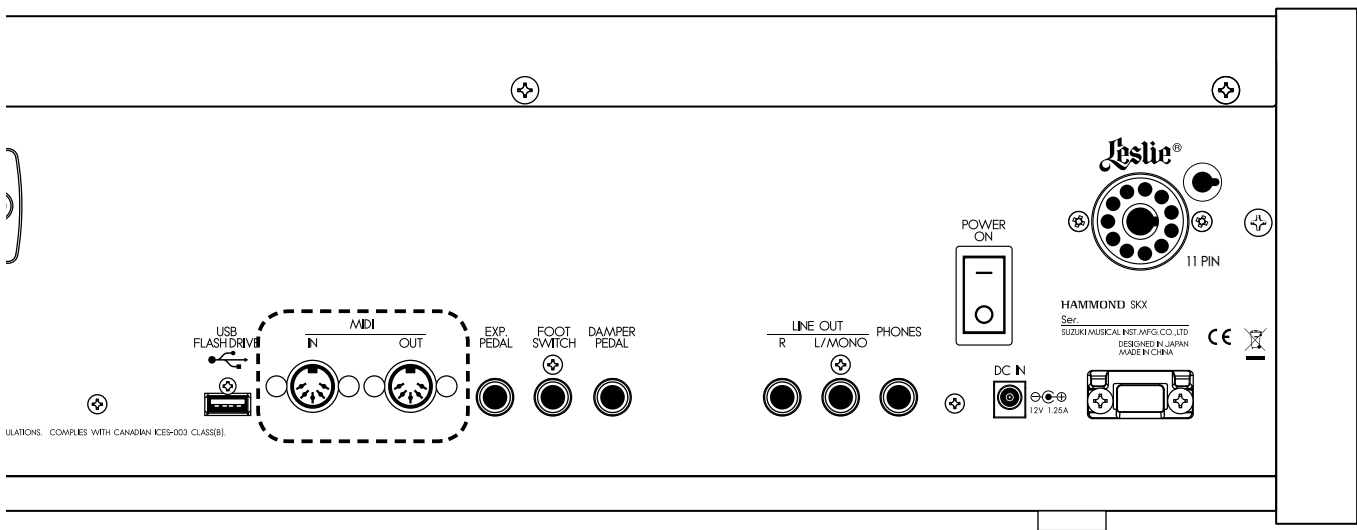

◆ MIDI OUT JACK

This is for sending performance information.

To an external MIDI sound module from SKX or to record performances and controls to an external sequencer.

◆ MIDI IN JACK

This jack is used for playing SKX from external MIDI equipment.

WHAT THE MIDI CAN DO ON THE SKX

On the SKX, the MIDI jacks are intended to do the following:

- ◆ use the MIDI keyboard to expand the number of keyboards.
- ◆ control an external sound generator such as a synthesizer or sampler.
- ◆ record/playback the performance on an external sequencer or computer.

For easily making these settings, the SKX is equipped with “MIDI Templates”.

WHAT IS A “MIDI TEMPLATE?”

Because MIDI can be used with such a wide variety of devices - such as synthesizers, sound modules, sequencers, keyboard controllers etc. - there are a number of features associated with MIDI, such as Program Change, Controller Change, etc., that allow each MIDI setup to be optimized for the best results in each application. However, making all of these settings manually can be quite time-consuming and error-prone.

Therefore, the SKX contains a number of pre-formatted settings for the various MIDI parameters which represent the most ideal settings for each MIDI environment. A group of these settings is called a MIDI Template.

See page 112 “MIDI” for information on how to select the MIDI Template you want to use.

MIDI CHANNEL

MIDI has 16 “Channels”. Information divided into 16 channels can be transmitted through one MIDI cable.

The channel must match between the sender and the receiver. If not, the machines can not “hear” what the other “says”.

MAIN MIDI MESSAGE

The MIDI information is grouped into a channel message per each of the 16 channels and a system message for all channels. There are more details in the MIDI IMPLEMENTATION CHART.

CHANNEL MESSAGE

◆ NOTE ON

This data tells: which key (Note Number) is played, at what speed (Velocity) and the strike/release (Note On/Off).

◆ PROGRAM CHANGE

Control Channel:

Switches the internal Patches of the SKX.

External Zone Channel:

Switches the external MIDI equipment's Patches.

◆ CONTROL CHANGE

The messages are transmitted (sent or received) in accordance with the motion of select controls on the top panel, any foot or auxiliary pedals, or any MIDI controller information.

SYSTEM MESSAGE

◆ SYSTEM EXCLUSIVE MESSAGE

This message is for transmitting the particular data between compatible equipment of the same model or same make.

The SKX can do a memory dump (= sending the total information compliment on-board) and recording them to an external sequencer.

MIDI STRUCTURE

The SKX has “Keyboard Channels” to transmit playing information of the keyboards and “External Zone Channels” to control external MIDI equipment on the keyboards.

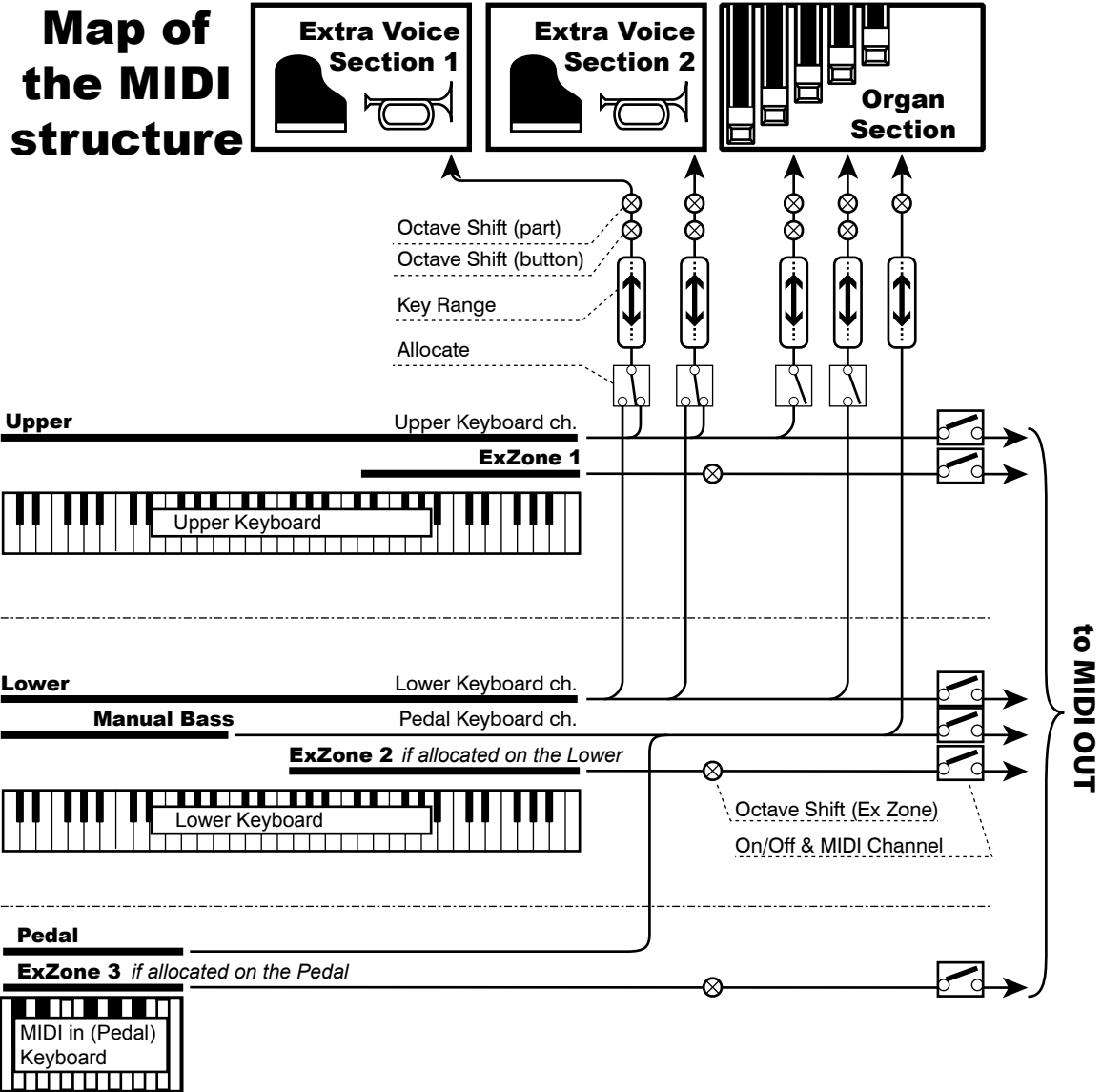

◆ KEYBOARD CHANNELS

The Keyboard channels transmit the playing information of the Upper, Lower and Pedal parts. These are used to exchange playing information with an external sequencer.

Through the Upper channel, besides the keyboard information, that of each controller is transmitted.

◆ EXTERNAL ZONE CHANNELS

The External Zone channels are for using SKX as a simple master keyboard to control the external MIDI equipment. These are Patch parameters, and it is possible to make different settings to each Patch.

There are 3 External Zones in total. Each can be allocated to the desired keyboards (for example, 3 zones for the Upper keyboard and 1 each for the Upper / Lower / Pedal keyboards).

◆ EXPANDED KEYBOARDS

When the MIDI Pedalboard is expanded for Pedal part, they behave as if the built-in keyboards on the SKX, and, not only sounds the built-in sound generator, but also are transmitted through the MIDI OUT jack to the Keyboard channels as well as transmitted to the External Zones.

USING AN EXTERNAL SEQUENCER

This is to record/playback the performance by connecting an external sequencer or computer to the SKX.

◆ Recording a performance to an external sequencer

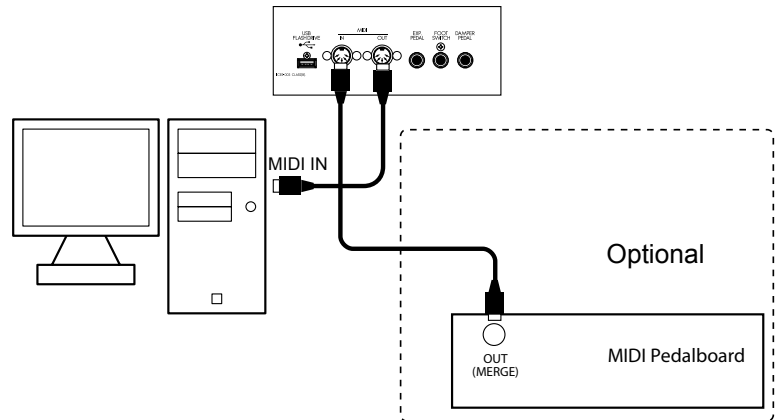

1. Connect as illustrated above.
2. Call the others than the "Use Ex." of MIDI template (P. 112)
The performance can be recorded by Keyboard channels. It cannot be recorded the control of the External Zones in this hook-up*1.
3. Set the Keyboard channels.
Set the MIDI channel of the SKX (TX KBD) to that of the external sequencer.
4. Start recording of the external sequencer.
5. Send the memory dump if necessary.
6. Start your performance.

*1 To record the control of External Zones, addition of above illustration, connect MIDI IN of controlled MIDI equipment to MIDI OUT of external sequencer, and set Echo ON the external sequencer.

When the playback, connect the MIDI OUT of external sequencer to MIDI IN of controlled MIDI equipment instead of the SKX.

◆ Sequencer playback

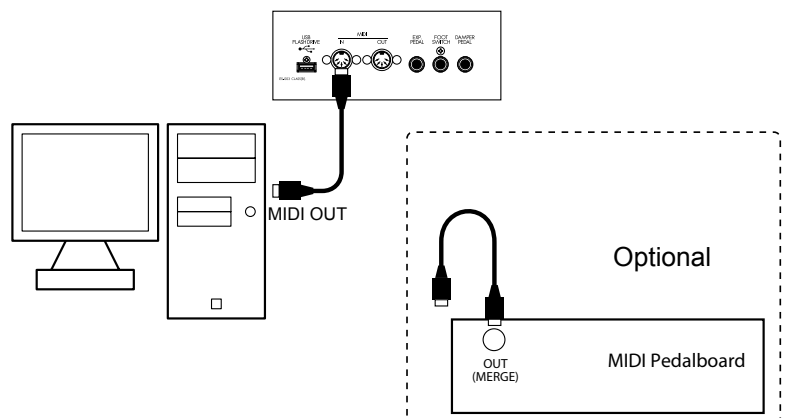

1. Connect as illustrated.
2. Call the MIDI template "Basic". (P. 112)
3. Set both the Keyboard channel and the control channel.
Set the MIDI channel of the SKX (RX KBD) at that of the external sequencer.
4. Start playback of the external sequencer.

You can control an external MIDI sound module with the built-in keyboard and the expanded MIDI keyboard.

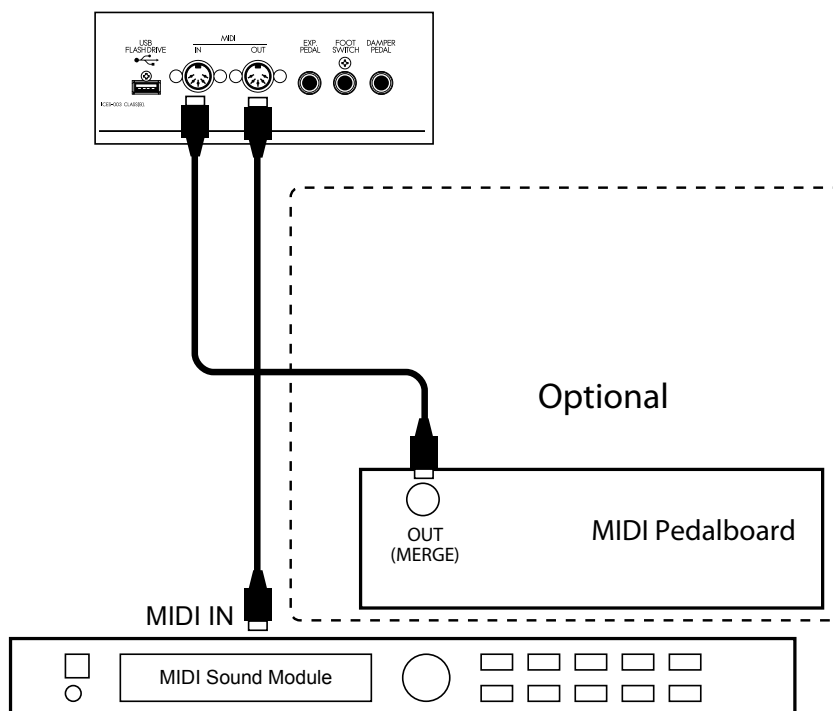

1. Connect as illustrated.

Connect the MIDI OUT of the SKX to the MIDI IN of the MIDI sound module.

2. Call the MIDI template “Use Ex. xxx”. (P. 112)

By this, the External Zone performance is sent from the MIDI OUT instead of Keyboard channels.

Use different MIDI templates, depending whether the keyboard is expanded or not.

3. Set each zone, and, if necessary, record to the Patches.

See the next paragraph “ZONES” for the setting details.

tips WHY USING EXTERNAL ZONES

You can control the MIDI equipment by using Keyboard channels (easier) sure, but it makes some problem. Probably the program number is different between SKX and MIDI equipment that you wish to use. About octave, velocity sensitivity, and so on?

The External Zone is a solution. It has a program number, octave, velocity sensitivity and so on by each Patch. When a Patch is called, various messages for MIDI equipment will sent automatically.

ZONES

To control external MIDI equipment, ranges on the keyboard of the SKX are assigned. They are called “External Zones”.

The range of the built-in sound engine on the SKX (called “Internal Zone”) is set at the same time. You can use each separately on a same keyboard.

Each MIDI keyboard connected to the MIDI IN jack can control the external MIDI equipment with the External Zone.

To locate this mode:

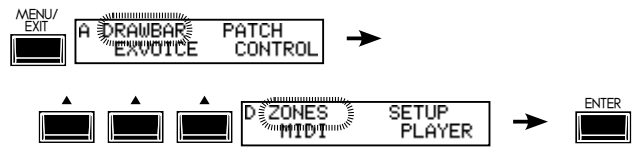

See “Function mode” (P. 66) for operation details.

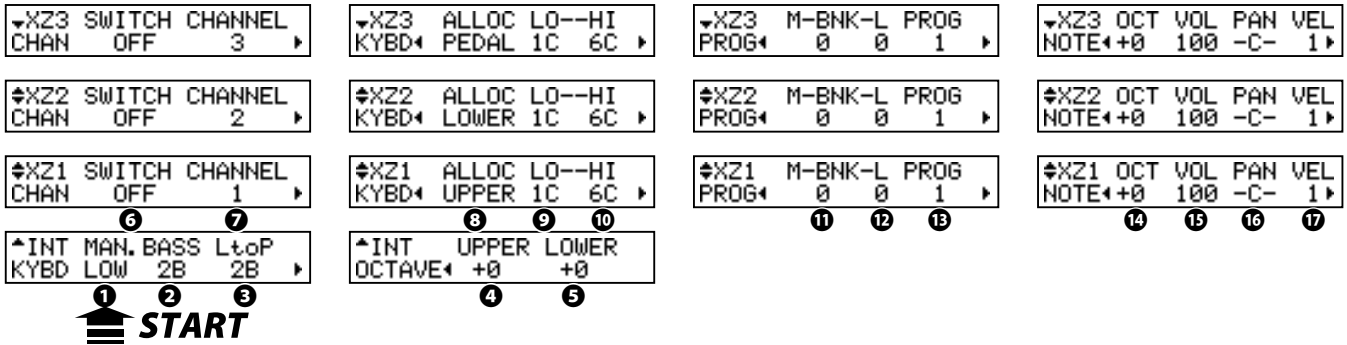

◆ WHAT IS DISPLAYED ON THE UPPER LEFT?

On the upper left of the Zone mode, the Zone to be operated now is displayed.

INT: Internal zone

XZn: External zone (#n)

◆ INTERNAL ZONE

① MANUAL BASS - MODE

This is for setting the how the Manual Bass (P. 32) works.

LOW: Sounds on lowest note if a chord is played.

CHRD: Sounds suitable bass note if a chord is played on Lower part.

POLY: Sounds the chord if a chord played.

② MANUAL BASS - LIMIT

Sets the upper limit note for the Manual Bass function.

④ OCTAVE - UPPER

Sets the octave of the Upper part. It is linked with the [OCTAVE UP], [OCTAVE DOWN] buttons on the top panel.

⑤ OCTAVE - LOWER

Sets the octave of the Lower part.

◆ EXTERNAL ZONE

⑥ SWITCH

Turns MIDI transmission “ON” or “OFF” for the selected Zone.

⑦ MIDI CHANNEL

Sets the MIDI channel for the selected Zone.

The setting range is 1 to 16.

⑧ KEYBOARD ALLOCATE

Selects which keyboard to allocate the selected Zone.

If you do not have a MIDI Pedalboard, set the “UPPER” and “LOWER” only.

If you are using MIDI Pedalboard, you can use it to control the External Zones by selecting “PEDAL”.

If you are connected to an external synthesizer and you want to send Program Changes, etc. only without transmitting Note data, set this parameter to “OFF”.

⑨ ZONE - LOW

⑩ ZONE - HIGH

Sets the Low and High note ranges for the selected Zone.

NOTE: 9 and 10 can also be set by pressing the [RECORD] button with play the desired note on the keyboard.

⑪ PROGRAM - BANK MSB

⑫ PROGRAM - BANK LSB

⑬ PROGRAM - PROGRAM CHANGE

Sets Bank Select and the Program Change to send to the selected Zone.

Bank Select and Program Change are used to switch sounds on a connected MIDI unit such as a synthesizer or sound module.

Please consult the Owners Manual of your MIDI equipment to obtain the proper settings for Bank and Program Changes.

You can select the Bank MSB and LSB at 0 to 127, the Program Change at 1 to 128.

⑭ NOTE - OCTAVE

Sets octave shift to the selected Zone. If an external synthesizer sound in a different octave from that you desire, adjust this parameter.

The setting range is -2 to +2.

⑮ NOTE - VOLUME

Sets the volume (Control Change #7) to the selected Zone. However, if CC# (20) is at “VOL”, this setting value is null.

The setting range is 0 to 127.

↓XZ3 MIN-MAX CC# EXP.◀ 40 127 11:EXP▶	↓XZ3 DAMPER MSGS◀ ON
↕XZ2 MIN-MAX CC# EXP.◀ 40 127 11:EXP▶	↕XZ2 DAMPER MSGS◀ ON
↕XZ1 MIN-MAX CC# EXP.◀ 40 127 11:EXP▶	↕XZ1 DAMPER MSGS◀ ON
18 19 20	21

16 NOTE - PAN

Sets the Pan of the selected Zone (Control Change #10).
The setting range is L64(Left) - C(Center) - R63(Right).

17 NOTE - VELOCITY

Sets the character of the velocity to send to the selected Zone.
The setting range is OF and 1 to 4. At OF, the velocity is fixed at 100. The “touch” (velocity response) of the keyboard progresses from 1 (heavier) through 4 (lighter).

18 EXPRESSION - MINIMUM

19 EXPRESSION - MAXIMUM

Sets the range to “compress” the Expression information to send to the selected Zone.

On the electronic organ, even if the Expression pedal is fully returned, sound does not perfectly silenced. If a GM sound generator is used, no sound comes out. This is a parameter to balance it.

The setting range is MIN at 0 to 63, MAX at 64 to 127.

20 EXPRESSION - CONTROL NUMBER

Sets the MIDI Control Change number (CC#) of the Expression pedal.

The way of controlling volume differs type by type of the MIDI equipment to be connected. This parameter is for setting a proper number to control the volume of the connected MIDI equipment.

You can select 7: VOL, 11: EXP.

21 MESSAGE - DAMPER

Sets whether to transmit the Damper information (Control Change #64) to the selected Zone.

NOTE: The parameters in these modes are Patch parameters, and are recorded to the Patch.

PANIC FUNCTION AND PARAMETER RE-LOAD

If a problem occurs to the MIDI system, it may be caused by a cypher. When the SKX and an external MIDI equipment is connected, such a problem could happen due to the difference between the setting contents of both equipment.

In such a case, touch both [▲], [▼] buttons. Both the “All Note Off” and “Reset All Controllers” are sent to the MIDI channels of all External Zones (Panic Function), then the settings of all External Zones are reloaded (sent again).

In this mode, you make the basic MIDI settings and the memory dump operation.

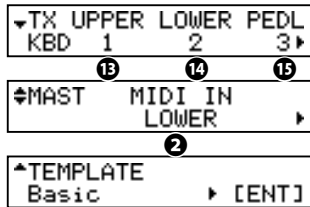

1 START

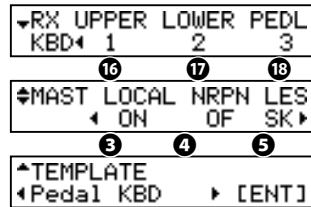

To locate this mode:

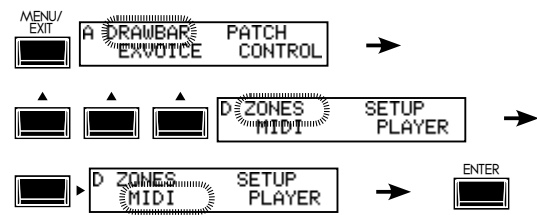

See "Function mode" (P. 66) for operation details.

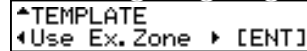
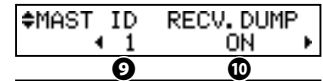
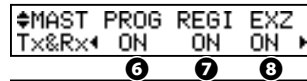

◆ MIDI TEMPLATE

1 MIDI TEMPLATE

This allows you to recall the MIDI Template you want to use.

Use [◀][▶] buttons to select the desired Template and press the [ENTER] button to make your selection.

See "MIDI TEMPLATE" in the Appendix (P. 139) for details of each MIDI Template.

◆ MASTER

2 MIDI IN

This is for switching the MIDI jack function.

LOWER

Incoming MIDI data plays the LOWER part and are retransmitted to the LOWER channel (#14) of the MIDI OUT jack, regardless of the settings of the MIDI channel.

PEDAL

Incoming MIDI data plays the PEDAL part and are retransmitted to the PEDAL channel (#15), regardless of the settings of the MIDI channel.

LOW + PED

Incoming MIDI data plays the LOWER and the PEDAL parts in accordance with the MIDI channel settings and are retransmitted to the LOWER (#14) and the PEDAL (#15) MIDI channel.

SEQUENCE

Incoming MIDI data plays the UPPER, LOWER and PEDAL parts in accordance with the MIDI channel settings, but is not retransmit.

UPPER

Incoming MIDI data plays the UPPER part and are retransmitted to the UPPER channel (#13), regardless of the settings of the MIDI channel.

UPP + PED

Incoming MIDI data plays the UPPER and the PEDAL parts in accordance with the MIDI channel settings and are retransmitted to the UPPER (#14) and the PEDAL (#15) MIDI channel.

3 LOCAL

This switches the Local Control "ON" or "OFF".

When switched "ON", the keyboards and the internal sound engine are connected. When "OFF", the keyboards and the sound engine are disconnected no sound is played.

You can use SKX as two different equipment; the MIDI keyboard and the sound module at the same time.

4 NRPN

This switches the transmission/reception of the NRPN (Non-Registered Parameter Number) "ON" or "OFF".

On the SKX it is used for transmitting the messages such as the Drawbar Fold Back or the Leslie ON. The NRPN is transmitted through the UPPER channel.

When switched "ON", it is transmitted. When "OFF", not transmitted.

5 LESLIE

This is for controlling how to send Leslie Parameters. The Leslie Parameters sent on UPPER Channel.

SK:

The Leslie Parameters will be sent out on the SKX original NRPN address and data.

21:

The Leslie Parameters will be sent out for Leslie 21 series NRPN address and data.

When the Cabinet Number is selected (i.e. by Patch), the parameters are sent out also.

NOTE: This parameter will changed automatically when the Leslie speaker is connected / disconnected.

6 PROGRAM CHANGE

This switches the transmission/reception of the Program Change "ON" or "OFF". When "ON", transmitted. When "OFF", not transmitted.

7 DRAWBAR REGISTRATION

This switches the transmission/reception of the Drawbar settings "ON" or "OFF". When "ON", transmitted. When "OFF", not transmitted.

8 EXTERNAL ZONE

This switches the transmission/reception of the External Zones as a whole "ON" or "OFF". When "ON", transmitted. When "OFF", not transmitted.

9 DEVICE ID

This sets the Device ID for transmission/reception of the System Exclusive messages such as the Memory Dump (#11, 12). For example, the receiving is neglected, when the Device ID does not match, even if the messages are the same.

◀MAST TEMPORARY DUMP
◀[ENTER] to Send▶

11

◀MAST ALL DUMP
◀[ENTER] to Send▶

12

10 RECEIVE DUMP

This switches reception of Memory Dump “ON” or “OFF”.

On the SKX the total onboard memory can be transmitted as a Memory Dump, as System Exclusive messages. If you do not want the contents of the SKX be changed by sequencer play, set this to OFF.

When ON, transmitted. When OFF, not transmitted.

11 TEMPORARY DUMP

Sends the Memory Dump.

When you press the [ENTER] button in this mode, the Temporary (the present settings) are sent as a whole from the MIDI OUT jack.

If you record the Temporary by doing this before you record your performance to an external sequencer, you can avoid the setting mismatching when you play it back later.

12 ALL DUMP

Sends the Memory Dump.

If you press the [ENTER] button in this mode, all the settings except the Voice Library contents are sent out of the MIDI OUT jack.

◆ KEYBOARD CHANNELS

Sets the MIDI channel to transmit at each part. The setting range is 1 to 16 and OF. At OF there is no transmission.

13 TX UPPER

Sets the MIDI channel for sending the UPPER part playing data, the control data of the SKX and that of the Leslie speaker.

14 TX LOWER

Sets the MIDI channel for sending the LOWER part playing data.

15 TX PEDAL

Sets the MIDI channel for sending the PEDAL part playing data.

16 RX UPPER

Sets the MIDI channel for receiving the UPPER part playing data, the control data of the SKX and that of the Leslie speaker.

17 RX LOWER

Sets the MIDI channel for receiving the LOWER part playing data.

18 RX PEDAL

Sets the MIDI channel for receiving the PEDAL part playing data.

NOTE: To avoid confusion of MIDI signals, set each MIDI channel including the external zones (P. 110) to different numbers.

NOTE: The settings in this mode are not recorded to the Patches. They are recorded upon setting, and are common at all Patches.

tips TEMPORARY DUMP CONTENTS

The Patch parameters, Global parameters and system parameters of the Temporary (= the present setting values) are transmitted.

The contents of each Patch or that of the Leslie Cabinet are not transmitted. Use 'All Dump' or a USB Flash drive for saving them.

tips TO SAVE ALL

All the setting values of the SKX are transmitted by 'All Dump', but the contents of the Extra Voice section Voice Library are not transmitted, because the data are enormous large.

Use the USB Flash drive to save all settings including the Voice Library.



A USB FLASH DRIVE port is built in on the SKX. You can save the setting of each Parameter as a file to it. The USB Flash drive can be used for the Music Player or as a Voice Library.

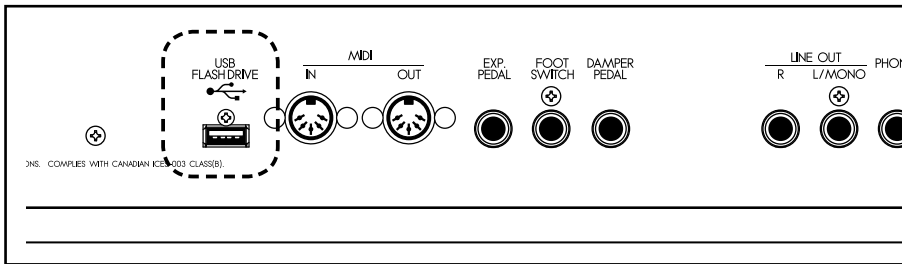

WHAT YOU CAN DO WITH THE USB FLASH DRIVE

- ♦ Save and Load Setups. Unlike the memory dump, it is possible to save all data including the Voice Library.
- ♦ Playback audio data of WAVs (44.1 kHz 16 bit) and MP3 (44.1 kHz, 128 kbps).
- ♦ Load the exclusive Voice Library.
- ♦ The capacity of a Setup file is 32K bytes, adding Voice Library up to 64M bytes.
- ♦ 1 USB Flash drive can save up to 99 Setup files.

ABOUT USB FLASH DRIVE

USABLE USB FLASH DRIVE

Consult our web site about compatible USB Flash drives.

in Europe: <http://www.hammond.eu>

in The US: <http://www.hammondorganco.com>

USB FLASH DRIVE CONNECTOR

1. Insert the USB Flash drive facing the correct direction, matching the upper side of it to that of the SKX.
2. Do not remove the USB Flash drive or switch OFF the power while accessing data (= while the "Please wait." is displayed). The data may be damaged.

FOLDER STRUCTURE

When the USB Flash drive is inserted to the SKX, the following folders are automatically created on the drive.

1. "HAMMOND" - "SKX" in the root folder.
2. "SETUP", "AUDIO", "LIB", "SYSTEM", "PATCH", "TWHEEL" below it

SETUP

The Setup and Whole file are saved here.

AUDIO

Audio files (MP3 and WAV) for the Music Player are copied here.

LIB

Voice Library (LIB) files are copied here.

SYSTEM

Place the system file to update the SKX here.

PATCH

The Patch file is saved here.

TWHEEL

Custom Tone Wheel file is saved here.

NOTE: If your USB Flash drive is formatted so the SKX cannot read it, the SKX will initialize your drive automatically.

tips EXTENSION OF THE SETUP FILE

The extension "SET" for Setup, "WHL" for Whole are automatically given to the file treated on the SKX.

tips EXTENSION OF THE PATCH FILE

The extension "PAT" is automatically given to the Patch file treated on the SKX.

tips EXTENSION OF THE TONE WHEEL FILE

The extension "TWL" is automatically given to the Tone Wheel file treated on the SKX.

A “fresh” The USB Flash drive must be formatted (or “initialized”). The initializing procedure is as follows:

NOTE: When initializing is completed, all the contents of the USB Flash drive are erased.

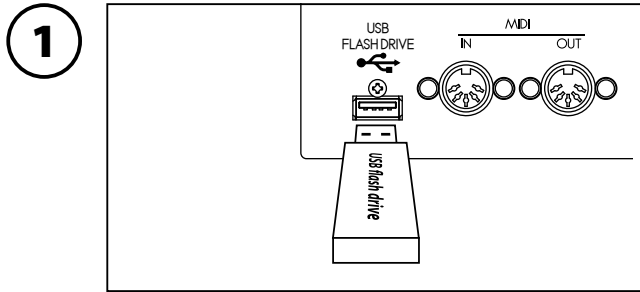

1 Insert the USB Flash drive to the USB FLASH DRIVE port. Wait until the display “Confirming USB. Please wait...” disappears.

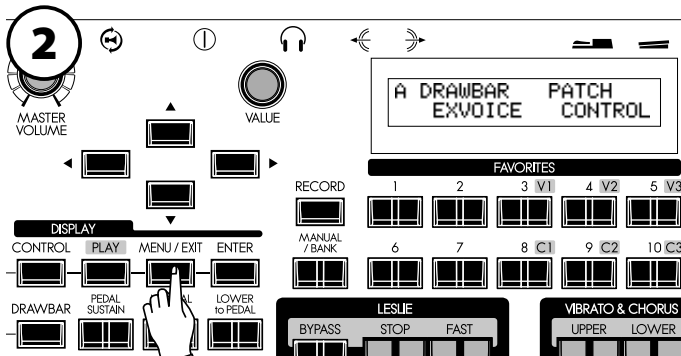

2 Press the [MENU/EXIT] button to display the Menu.

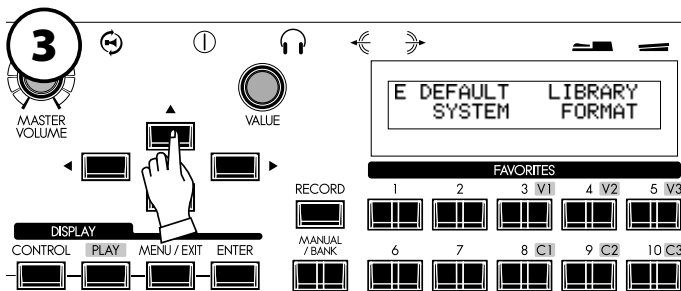

3 Select Page E with the [▲],[▼] buttons.

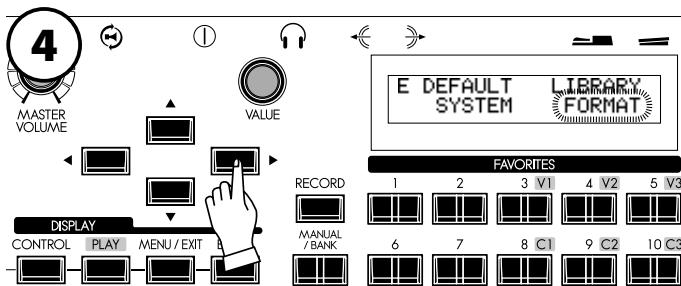

4 Select the “FORMAT” with the [▶] button.

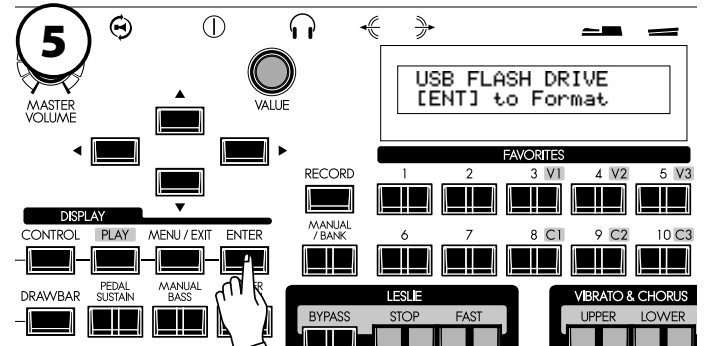

5 Press the [ENTER] button. The FORMAT (initialize) mode will be displayed.

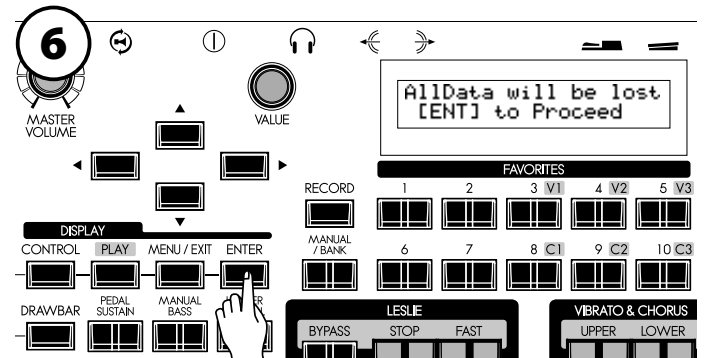

6 Press the [ENTER] button. Confirmation message is displayed.

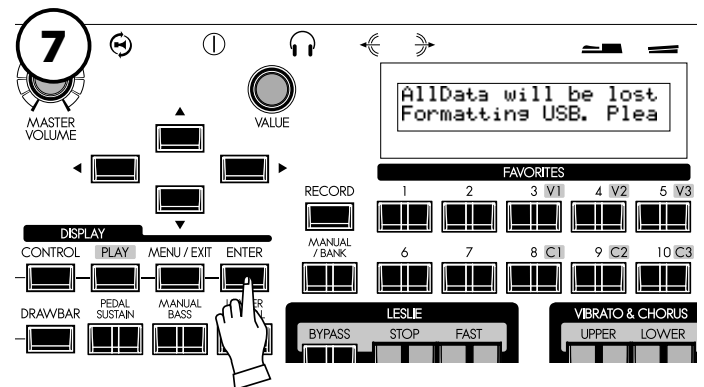

7 Press the [ENTER] button. Initialization starts. It takes about 3 seconds.

NOTE: If you choose to not initialize, just press the [MENU/EXIT] button.

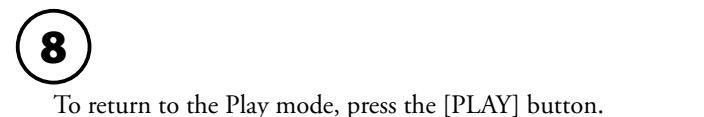

8 To return to the Play mode, press the [PLAY] button.

WORKING WITH SETUPS

Save or Load the Setups to/from the USB Flash drive in the SETUP mode.

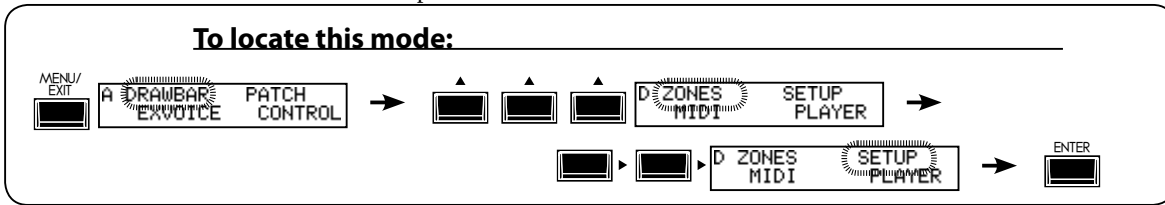

HOW TO READ THE DISPLAY

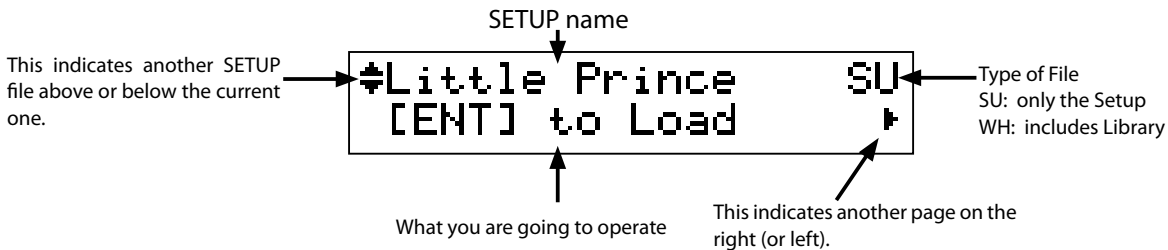

SAVING THE SETUP

1 INSERT THE USB FLASH DRIVE

Make sure that the USB Flash drive is correctly inserted.

2 INSERT THE USB FLASH DRIVE



Locate the SETUP mode. A Setup file name will displayed.

WHAT DOES THIS MEAN?

USB is not ready.

USB Flash drive is not correctly inserted.

3 SELECT "NEW FILE"

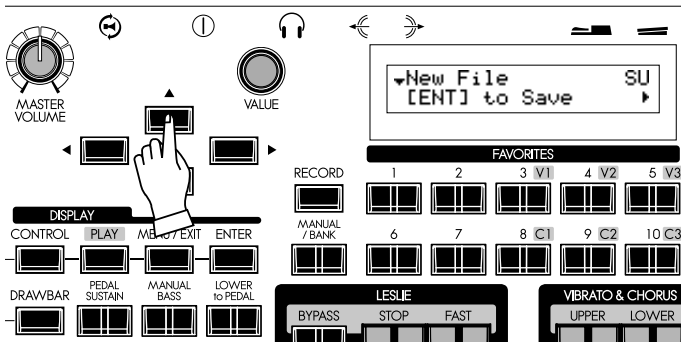

Select the "New File" by pressing the [▲] button (or turning the [VALUE] knob) a few times.

4 SELECT THE FILE TYPE

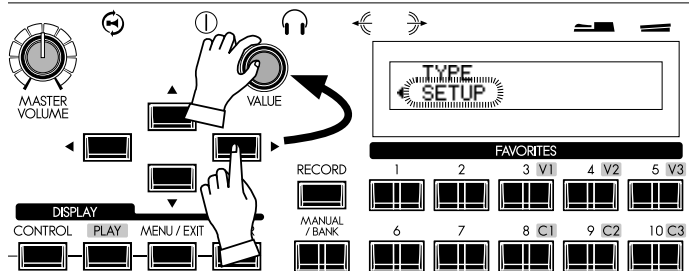

If you have Voice Libraries loaded into the SKX and want to save those as part of your Setup, press the [▶] button to display the "TYPE" and use the [VALUE] knob to change the value from "SETUP" to "WHOLE". Then press the [◀] button and return to the file display mode.

5 PRESS [ENTER] TO SAVE

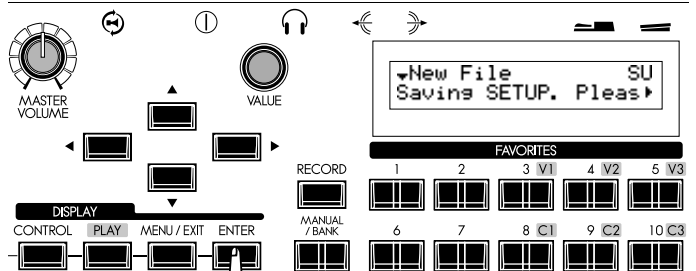

If you press the [ENTER] button, it is saved. With the WHOLE file, it can take up to 30 minutes maximum for saving.

6 COMPLETED

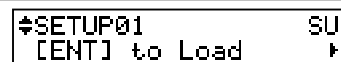

A temporary name "SETUPxx" is automatically given to the saved setup file.

CHANGING THE SETUP NAME

1 SELECT THE SETUP FILE



Select the setup file you want to change the name of with the [▲],[▼] buttons or the [VALUE] knob.

2 LOCATE THE NAMING MODE

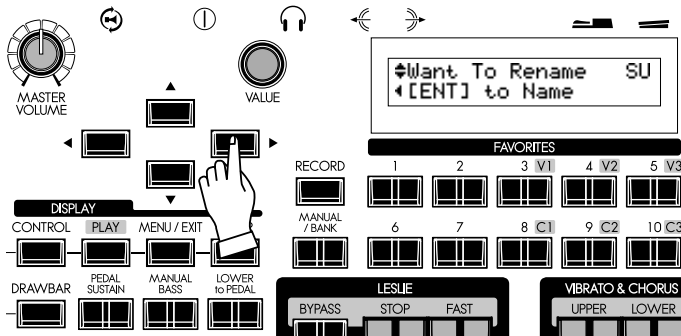

Press the [▶] button. "[ENT] to Name" is displayed.

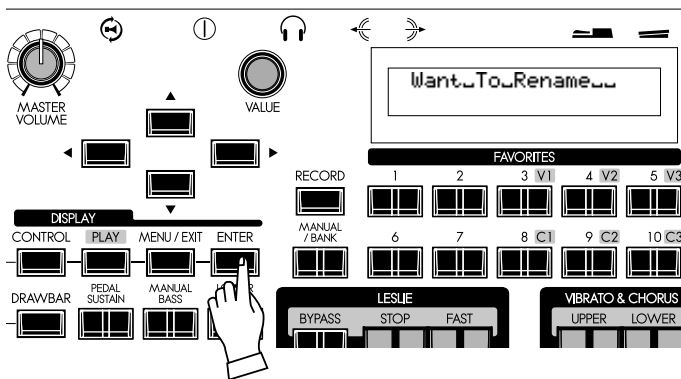

Press the [ENTER] button. This is the screen where the name is entered.

3 ENTER THE NAME

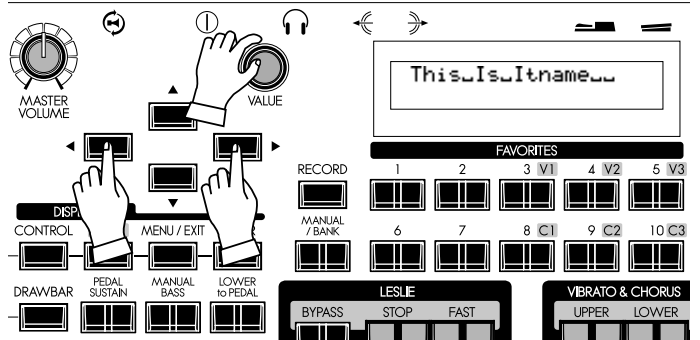

Enter the new setup name.

[◀],[▶] buttons

Move the cursor. The length is up to 16 letters.

[VALUE] knob

Select letters.

Valid characters are: digits, symbols, large and small alphabets.

4 PRESS [ENTER] TO NAME

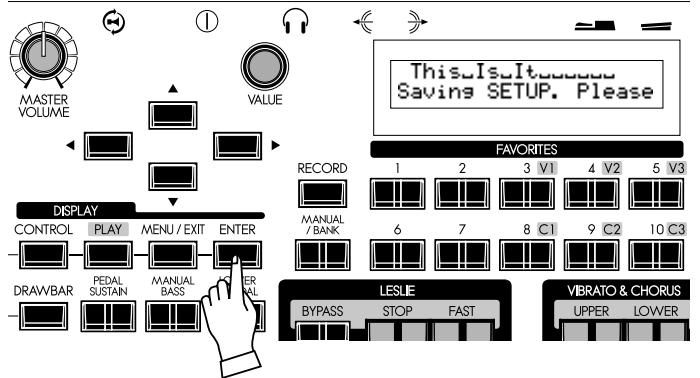

Press the [ENTER] button. The setup name is changed.

tips WHAT CONTENTS ARE SAVED?

Setup: Global parameter, Patch parameter, Leslie Cabinet, Custom Tone Wheel, Temporary (except the Expression Source and Device ID)

Whole: In addition to the Setups, the whole Voice Library in the SKX.

LOADING THE SETUP

NOTE: If you do this operation, the settings in the SKX are replaced with the newly loaded setups. You should save important data beforehand (p. 118).

① INSERT THE USB FLASH DRIVE

Make sure that the USB Flash drive is correctly inserted.

② LOCATE THE SETUP MODE



Locate the SETUP mode. A Setup file will displayed.

③ SELECT THE SETUP FILE

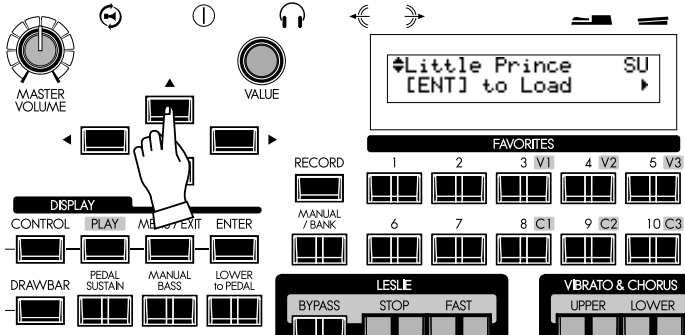

Select the Setup file to load with the [▲],[▼] buttons or the [VALUE] knob.

④ PRESS [ENTER] TO DECIDE

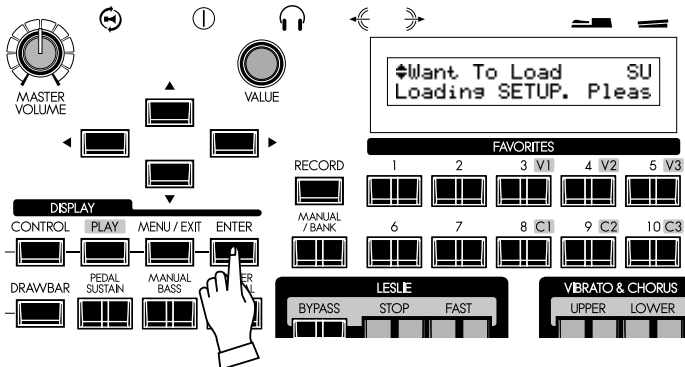

Press the [ENTER] button. The Setup is loaded.
In case of the WHOLE file, loading can take up to a maximum 30 minutes.

DELETING THE SETUP

① INSERT THE USB FLASH DRIVE

Make sure that the USB Flash drive is correctly inserted.

② LOCATE THE SETUP MODE



Locate the SETUP mode. A Setup file will displayed.

③ SELECT THE SETUP FILE

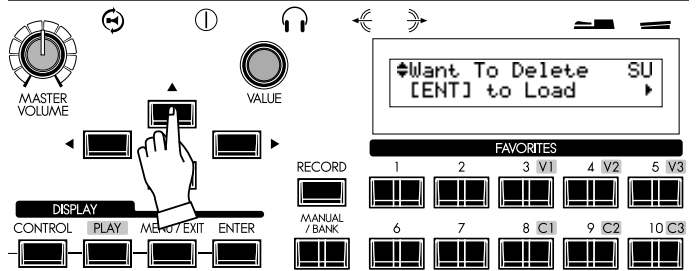

Select the setup file to delete with the [▲],[▼] buttons or the [VALUE] knob.

④ SELECT THE OPERATION

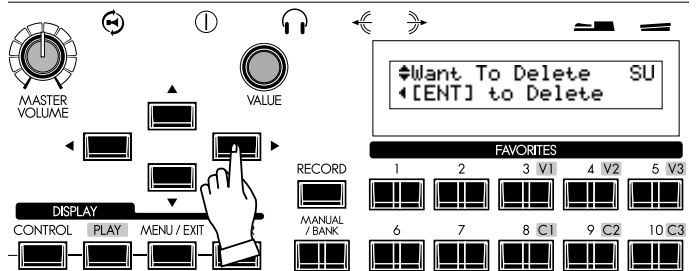

Press [▶] button twice. "[ENT] to Delete" is displayed.

⑤ PRESS [ENTER] TO DECIDE

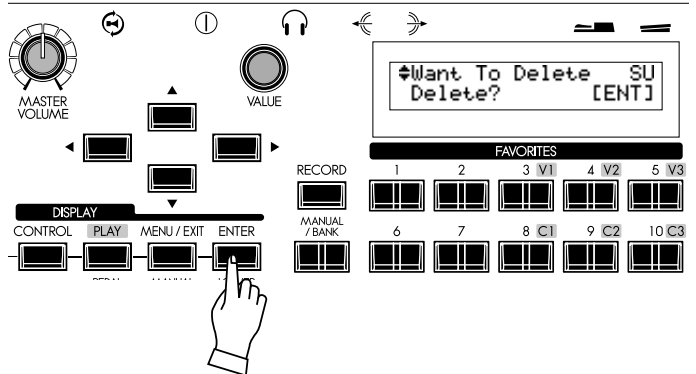

Press the [ENTER] button. "Delete?" is displayed. Now press the [ENTER] button again. The setup is deleted.

NOTE: If you do not wish to delete the setup, touch the [MENU/EXIT] button.

Save or Load the Patches to/from the USB Flash drive in the PATCH mode, not SETUP mode on last page.

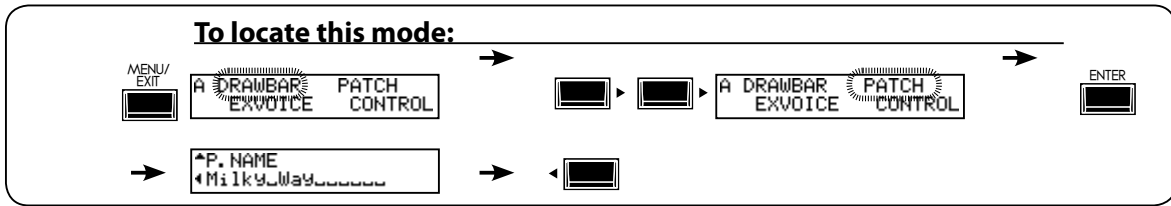

HOW TO READ THE DISPLAY

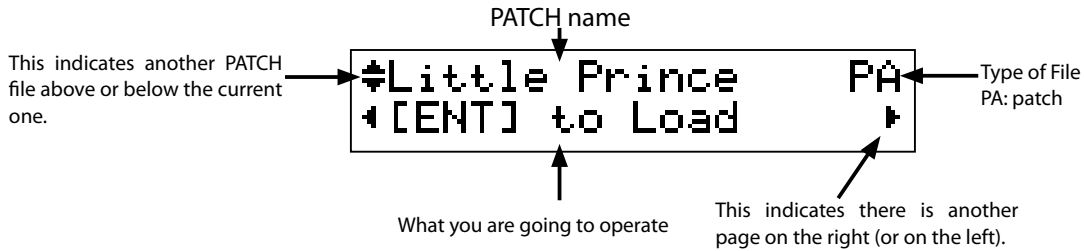

SAVING THE PATCH

1 INSERT THE USB FLASH DRIVE

Make sure that the USB Flash drive is correctly inserted.

2 SELECT THE PATCH

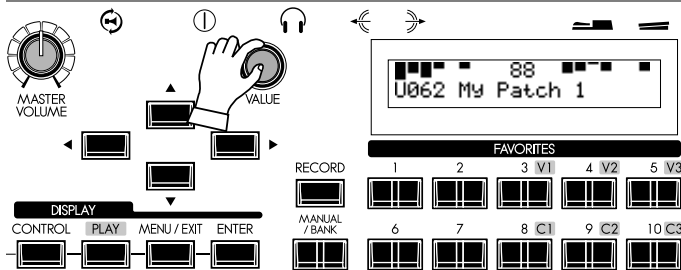

Choose the Patch which you wish to save.

3 LOCATE THE PATCH FILE MODE



To locate the PATCH mode, please refer to the illustration above, "To locate this mode".

WHAT DOES THIS MEAN?

USB is not ready.

USB Flash drive is not correctly inserted.

4 SELECT "NEW FILE"

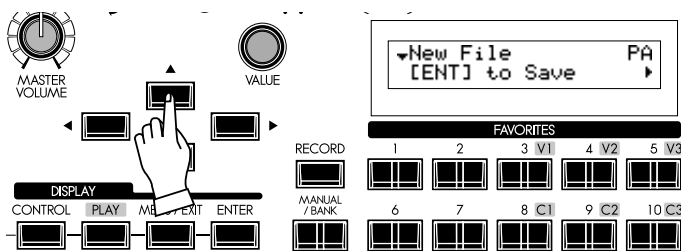

Select the "New File" by pressing the [▲] button (or turning the [VALUE] knob) a few times.

5 PRESS [ENTER] TO DECIDE

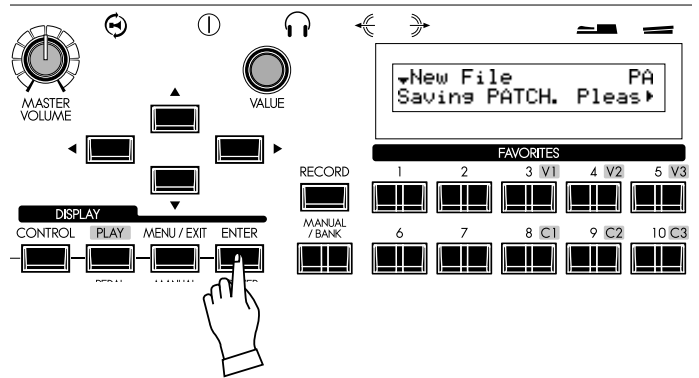

Press the [ENTER] button to save your Patch.

WHAT DOES THIS MEAN?

Same name exists.

The USB Flash drive already contains a file by that name. Modify the Patch name on the SKX, or delete the file with same name on the USB Flash drive (next page).

6 COMPLETED

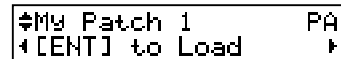

The Patch name is automatically given as the file name.

LOADING A PATCH

NOTE: If you do this operation, a Patch in the SKX are replaced with the newly loaded Patch. Therefore, it is recommended that you save your settings before loading a new Patch. (p. 121)

① INSERT THE USB FLASH DRIVE

Make sure that the USB Flash drive is correctly inserted.

② LOCATE THE PATCH FILE MODE



Locate the Patch file mode with refer to the illustration of the top of previous page.

③ SELECT THE PATCH FILE

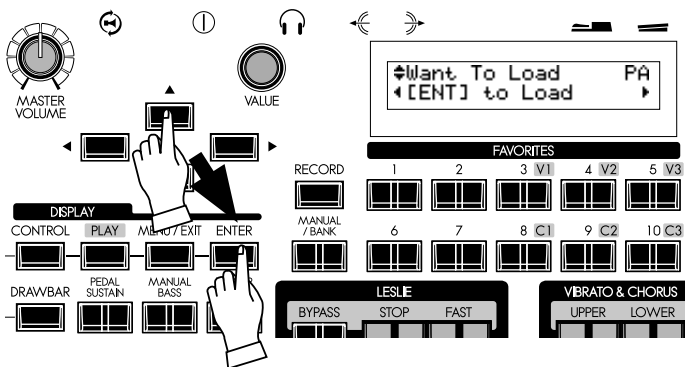

Select the Patch file to load with the [▲],[▼] buttons or the [VALUE] knob, and press [ENTER].

④ SELECT THE NUMBER TO REPLACE

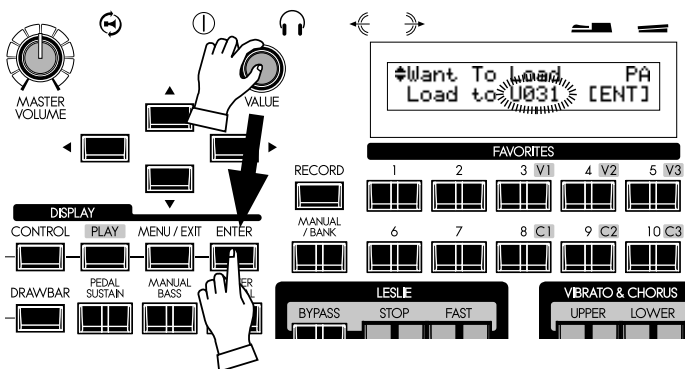

Select the Patch number to be replaced.
Press the [ENTER] button. The Patch is loaded.

DELETING THE PATCH

① INSERT THE USB FLASH DRIVE

Make sure that the USB Flash drive is correctly inserted.

② LOCATE THE PATCH FILE MODE

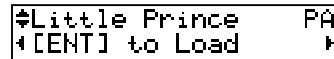

To locate the Patch mode, please refer to the illustration of the top of previous page.

③ SELECT THE PATCH FILE

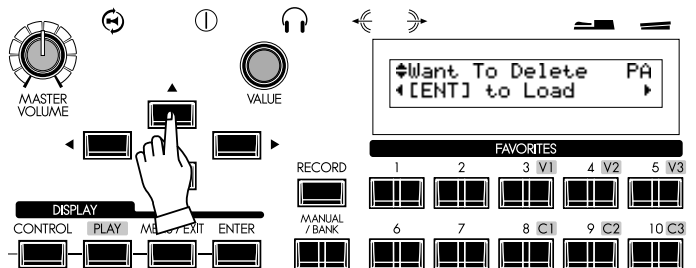

Select the Patch file to delete with the [▲],[▼] buttons or the [VALUE] knob.

④ SELECT THE OPERATION

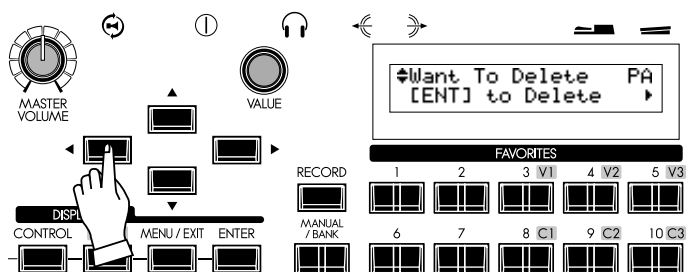

Press [◀] button once. "[ENT] to Delete" is displayed.

⑤ PRESS [ENTER] TO DELETE

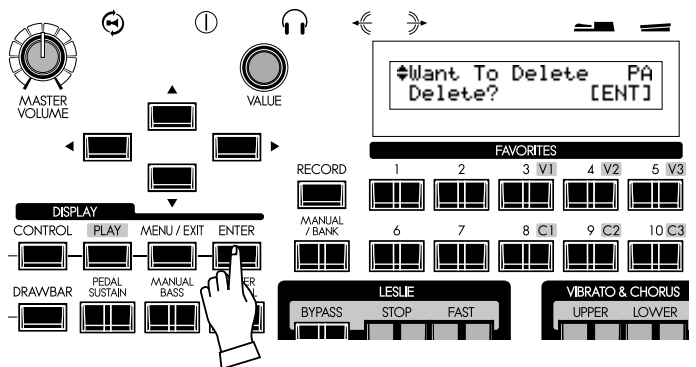

Press the [ENTER] button. "Delete?" is displayed. Now press the [ENTER] button again. The Patch is deleted.

NOTE: If you do not wish to delete the Patch, press the [MENU/EXIT] button.

Save or Load the Custom Tone Wheels to/from the USB Flash drive in the CUST. TW mode, not SETUP mode on previous page.

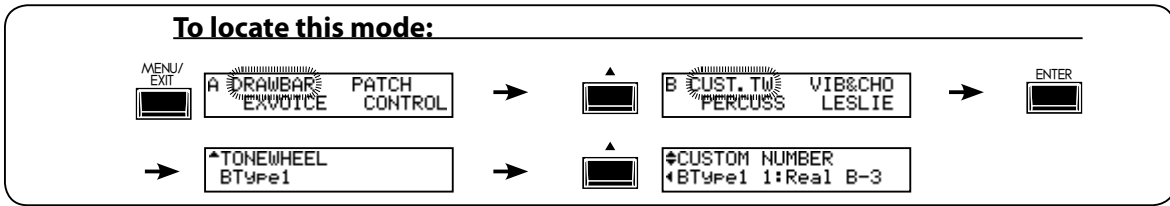

HOW TO READ THE DISPLAY

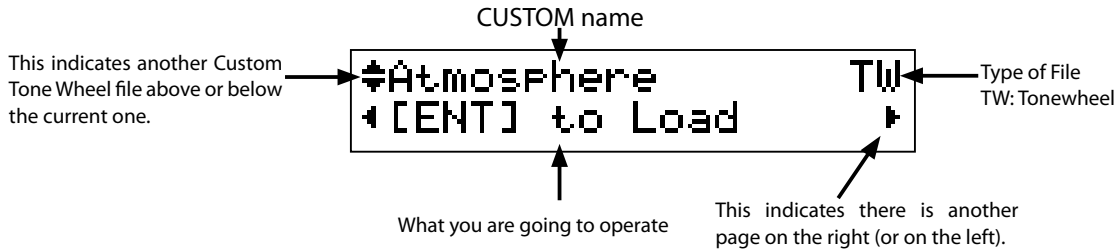

SAVE THE CUSTOM TONE WHEEL FILE

1 INSERT THE USB FLASH DRIVE

Make sure that the USB Flash drive is correctly inserted.

2 SELECT THE CUSTOM NUMBER

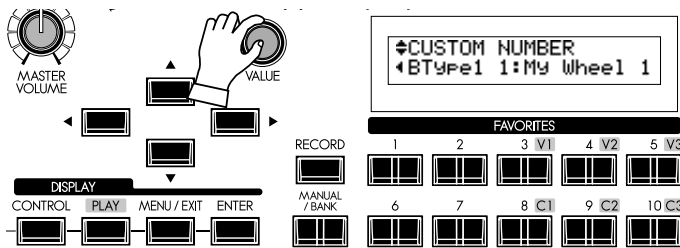

Choose the Custom Tone Wheel which you wish to save.

3 LOCATE THE TONE WHEEL FILE MODE

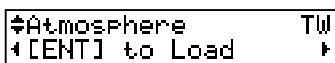

Locate the file mode by pressing [◀] button. A Tone Wheel file will be displayed.

WHAT DOES THIS MEAN?

USB is not ready.

USB Flash drive is not correctly inserted.

4 SELECT "NEW FILE"

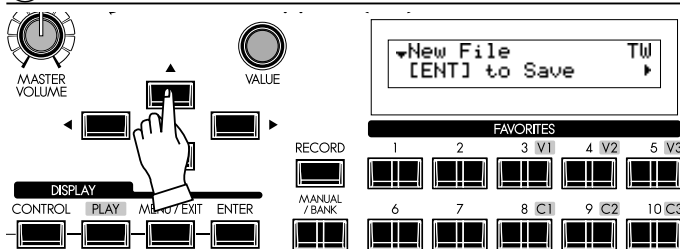

Select the "New File" by pressing the [▲] button (or turning the [VALUE] knob) a few times.

5 PRESS [ENTER] TO SAVE

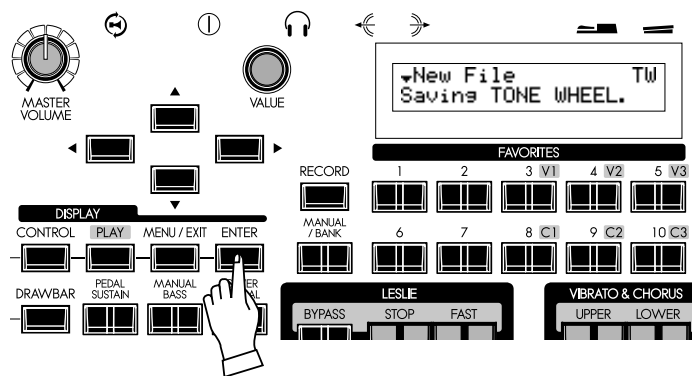

Press the [ENTER] button to save.

WHAT DOES THIS MEAN?

Same name exists.

There is a file with same name already. Change the Custom name on the SKX, or delete the file with same name in the USB Flash drive (next page).

6 COMPLETED

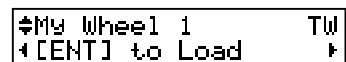

A file name same as Custom name is automatically given to the saved Custom Tone Wheel file.

LOADING A CUSTOM TONE WHEEL

NOTE: If you do this operation, a Patch in the SKX are replaced with the newly loaded Patch. You should save important data beforehand (p. 123).

① INSERT THE USB FLASH DRIVE

Make sure that the USB Flash drive is correctly inserted.

② LOCATE THE CUSTOM NUMBER MODE

Locate the Custom Number mode with refer to the illustration of top of previous page.

③ SELECT THE TONE WHEEL FILE

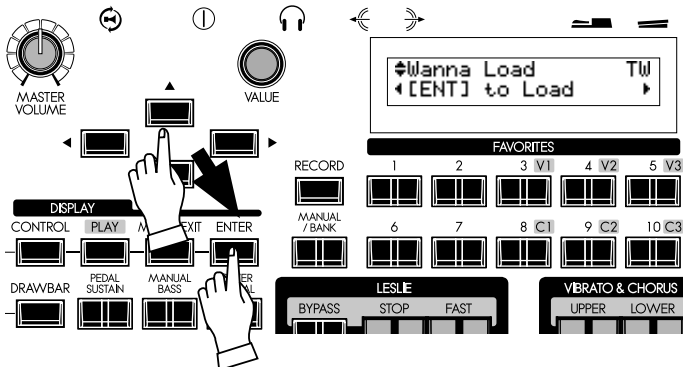

Select the Custom Tone Wheel file to load with the [▲],[▼] buttons or the [VALUE] knob, and press [ENTER].

④ SELECT THE DESTINATION

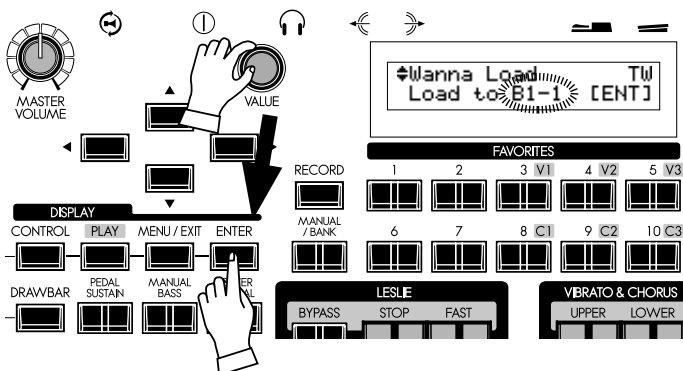

Select the Custom number to be replaced.

Press the [ENTER] button. The Custom Tone Wheel is loaded. The Tone Wheel set name is shorted in this page. Please refer below for detail.

- B1:** B-Type 1
- B2:** B-Type 2
- Mi:** Mellow

DELETING A CUSTOM TONE WHEEL

① INSERT THE USB FLASH DRIVE

Make sure that the USB Flash drive is correctly inserted.

② LOCATE THE CUSTOM NUMBER MODE

To locate the Custom Number mode, please refer to the illustration of top of previous page.

③ SELECT THE TONE WHEEL FILE

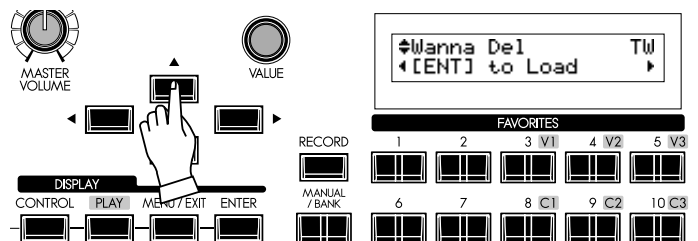

Select the Custom Tone Wheel file to delete with the [▲],[▼] buttons or the [VALUE] knob.

④ SELECT THE OPERATION

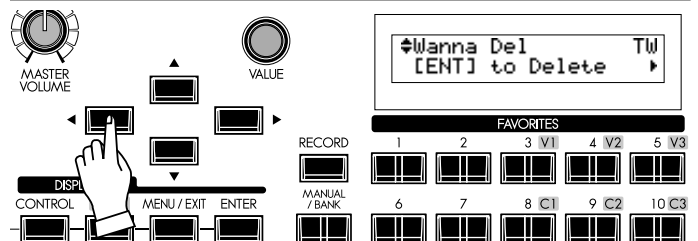

Press [◀] button once. "[ENT] to Delete" is displayed.

⑤ PRESS [ENTER] TO DECIDE

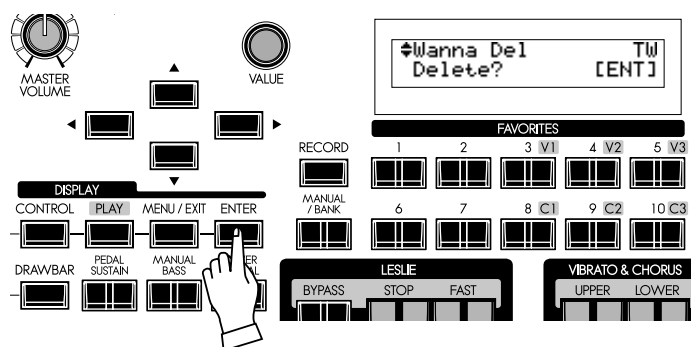

Press the [ENTER] button. "Delete?" is displayed. Now press the [ENTER] button again. The Tone Wheel file is deleted.

NOTE: If you do not wish to delete the Custom Tone Wheel, touch the [MENU/EXIT] button.



**MUSIC
PLAYER**

BEFORE PLAYING BACK

The Music Player feature of your SKX allows you to play audio files from a USB Flash Drive. In this way, you can use a previously recorded rhythm track as an accompaniment for a “one-man band” performance. You can also play along with, or simply listen to, favorite songs.

FILE TYPE AND PLACING FOLDER

FILE TYPE

The SKX Music Player will play the following file types:

- WAV type (44.1 kHz 16 bit stereo)
- MP3 type (44.1 kHz 64 to 192 kbps stereo)

NOTE: Playing along with an MP3 file may cause intermittent sound during playback. If you wish to use a Music File as an accompaniment track, it is recommended that you use WAV files.

tips HANDLING THE USB FLASH DRIVE

See the previous paragraph “Save your setup” for the handling details of the USB Flash drive (P. 116).

PLACING FOLDER

If you format a USB Flash drive in SKX or insert it, the folder for the Music Player files is automatically created.

\\HAMMOND\SKX\AUDIO\

Using your Computer, copy the files you wish to play in this folder. The SKX identifies up to 99 files.

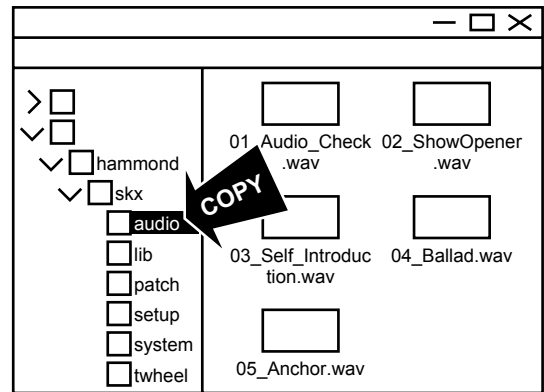

NAMES OF MUSIC TO BE DISPLAYED

If the audio file is a .WAV file, the file name is displayed as the song name.

If the audio file is a .MP3 file, the title of the ID3 tag (V1 or V2) is displayed as the song name.

PLAYING ORDER

If you wish to play audio files in a certain order - as part of a show, for example - use the Rename File feature on your computer to add a number to the beginning of the file name. See the example below.

Example:

- 00_Audio_Check.wav
- 01_Show_Opener.wav
- 02_Self_Introduction.wav
- 03_Hit_Number.wav
- 04_Ballad.wav
- 05_Anchor.wav

HOW TO READ THE DISPLAY

The illustration is of the Song List mode.

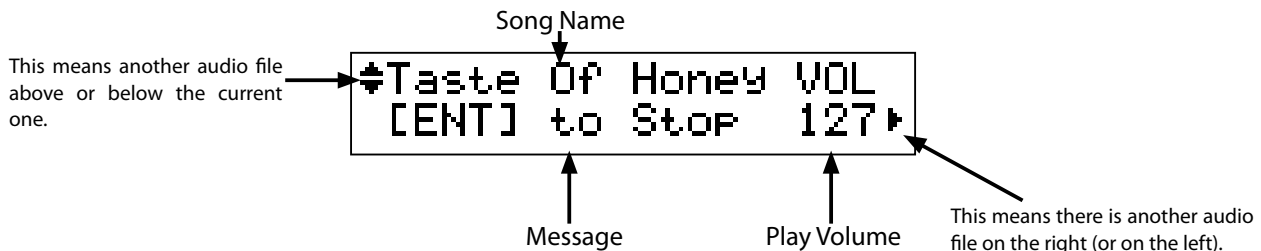

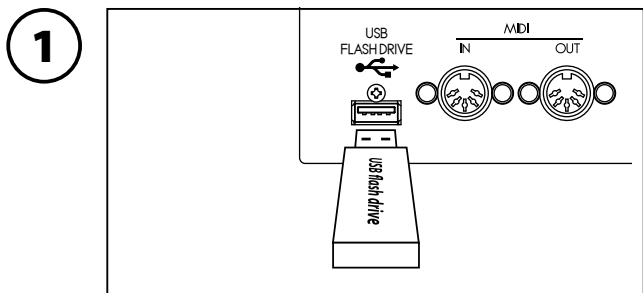

Insert a USB Flash drive to the USB FLASH DRIVE port. Wait until the display “Confirming USB. Please wait.” disappears.

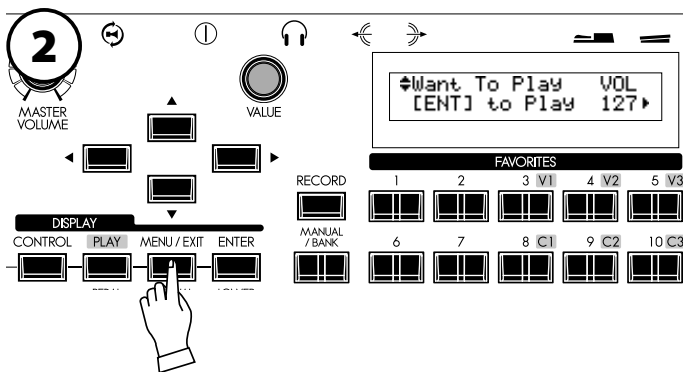

Locate Song List mode.

- A. Press the [MENU/EXIT] - Page D by [▲] - PLAYER by [▶] - [ENTER] button or,
- B. Press both [CONTROL] and [DRAWBAR] buttons simultaneously.

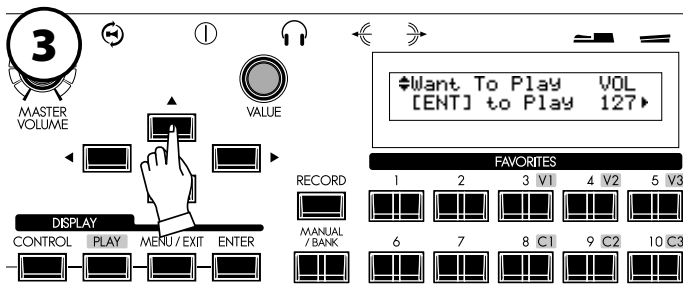

Use the [▲],[▼] buttons to find and select the audio file (Song) you wish to play.

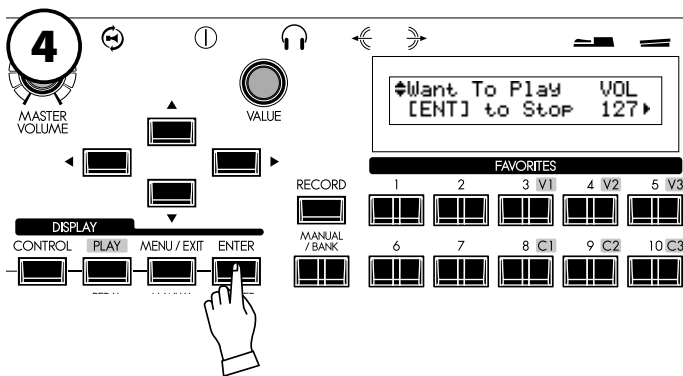

TO PLAYBACK

Press the [ENTER] button in this mode. The selected Song will begin playing. The bottom line of the display will read: [ENT] to Stop

TO RETURN TO THE BEGINNING

Press the [◀] button in this mode. The Song will rewind and begin playing from the beginning.

TO STOP

Press the [ENTER] button in this mode while the song is playing. The Song will stop playing and rewind back to the beginning. The bottom line of the display will read: [ENT] to Play

TO ADJUST THE PLAY VOLUME

Turn the [VALUE] knob to adjust the play volume in this mode. The volume is displayed as “VOL”.

MUSIC PLAYER MODES

1

Make sure that the USB Flash drive is inserted correctly.

2

Want To Play VOL
[ENT] to Stop 127

Locate Song List mode.

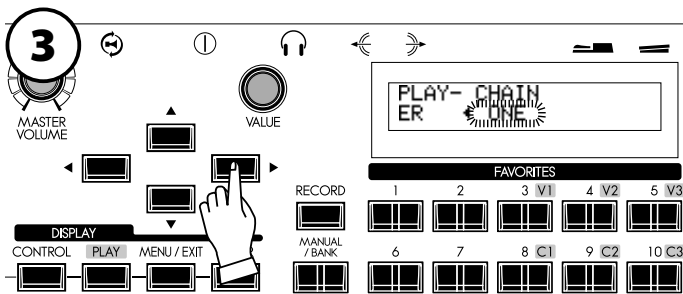

Use the [▶] button to select “CHAIN”.

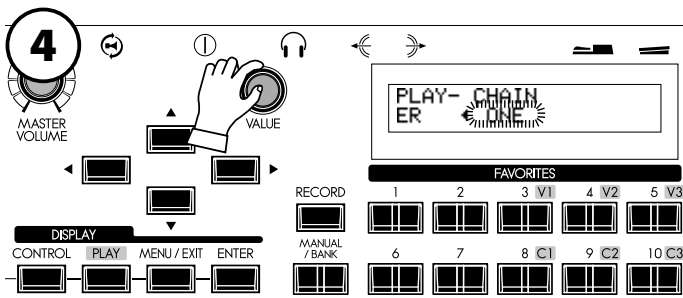

Select the option you wish with the [VALUE] knob.

ALL: Repeats all Songs. When the currently playing Song ends, the next Song automatically starts playing.

ONE: When the current Song ends, the playback will stop.

SHUF: When the current Song ends, a Song is selected at random from the files on the USB Flash drive, and starts playing.



WHAT IS VOICE LIBRARY?

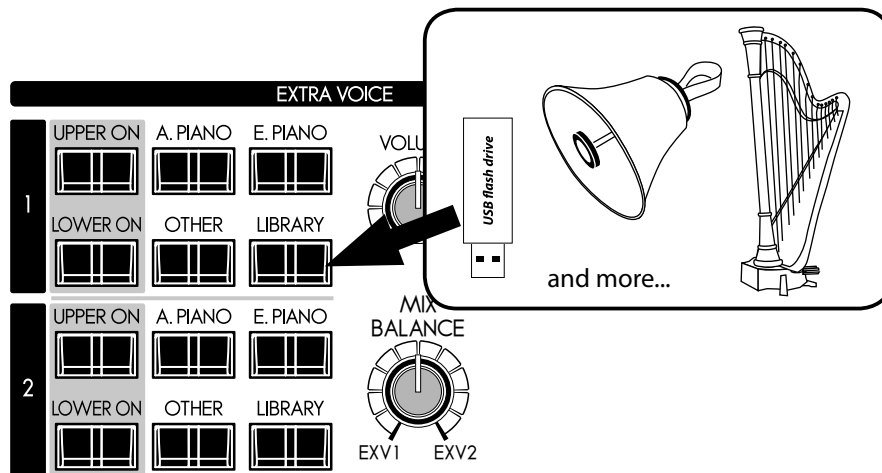

You can add new sounds to the Extra Voice sections by installing “Voice Libraries” to the instrument from a USB Flash Drive. These additional voices are accessed using the [LIBRARY] buttons of the Extra Voice sections.

Voice Libraries are available for download on the Hammond Organ website. Several instruments are pre-loaded as a default settings (P. 136).

tips HANDLING THE USB FLASH DRIVE

See the previous paragraph “Save your setup” for the handling details of the USB Flash drive (P. 116).

FILE TYPE AND THE PLACING FOLDER

FILE TYPE

The Voice Library is offered in the following types:

“Libxxxxx.SYS” (xxxxxx is name of Voice Library)

If the file is compressed in some way, you must expand it before it is ready for use.

PLACING FOLDER

When you insert the USB Flash drive to the SKX, the folder of the Voice Library is automatically created.

\\HAMMOND\\SKX\\LIB

Copy the library file you want to add here using the personal computer.

The SKX can identify up to 99 files.

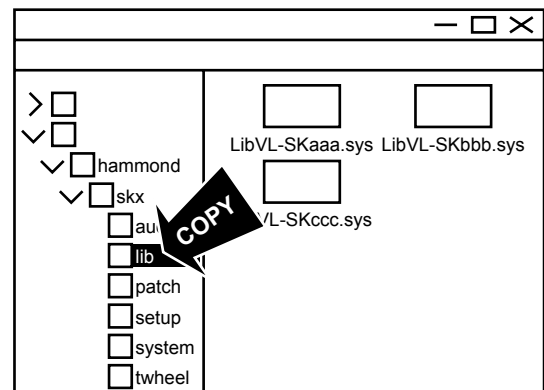

VOICE LIBRARY AND SETUPS

You can record settings created with the Voice Library to the Patches. If the contents of the Voice Library change, the sound of the Patch becomes different from that of the recorded one.

The memory dump or the USB Flash drive is used for saving and loading the setups. However, if you want to save/load including the Voice Library, be sure to record as WHOLE to the USB Flash drive. (P. 118 - 4) The contents of the Voice Library are not recorded in any other way.

LOADING THE VOICE LIBRARY

1 INSERT THE USB FLASH DRIVE

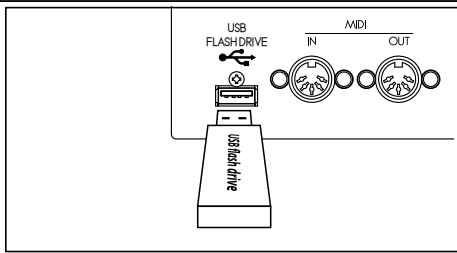

Insert the USB Flash drive to the USB FLASH DRIVE port. Wait until the display “Confirming USB. Please wait...” disappears.

2 LOCATE THE LIBRARY MODE

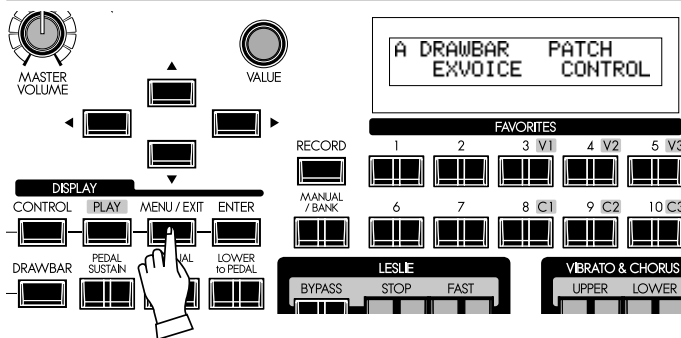

Display the menu with the [MENU/EXIT] button.

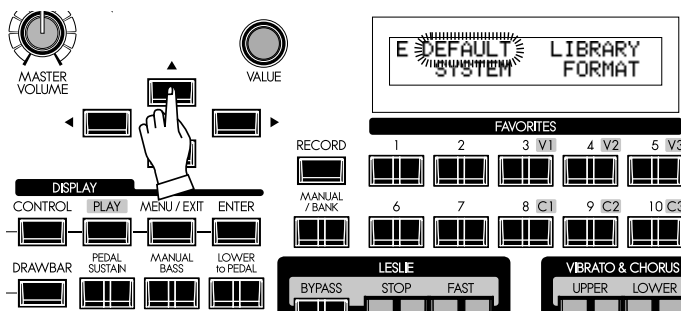

Select the Page E with the [▲],[▼] button.

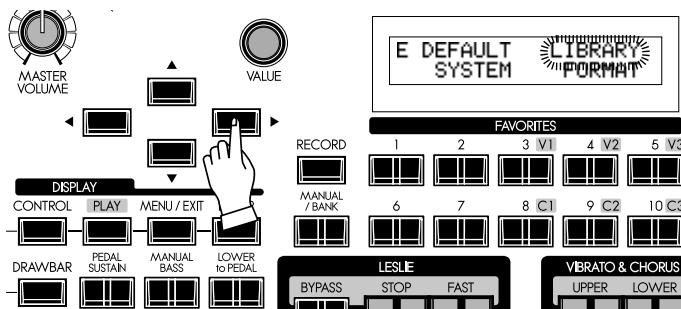

Select LIBRARY with the [▶] button.

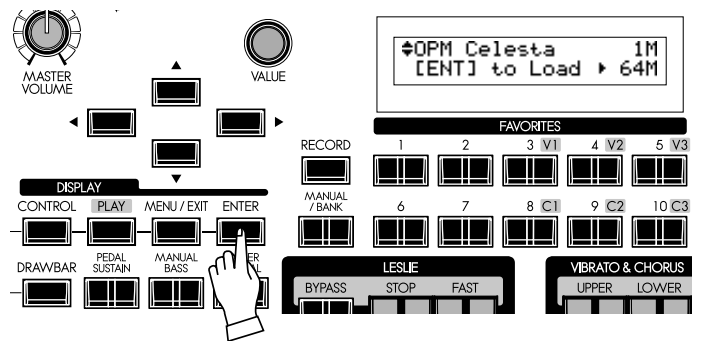

Press the [ENTER] button. Now you have come to the Library Function mode.

3 SELECT THE VOICE LIBRARY FILE

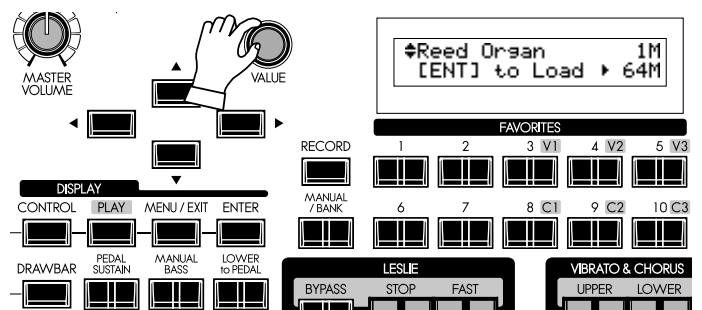

Select the Voice Library you want to additionally register with the [VALUE] knob or the [▲],[▼] buttons.

NOTE: The capacity of the Voice Library file on the upper right of the display, and the remaining capacity of the SKX on the bottom right. You can not additionally register larger files than the remaining capacity.

4 PRESS [ENTER] TO LOAD

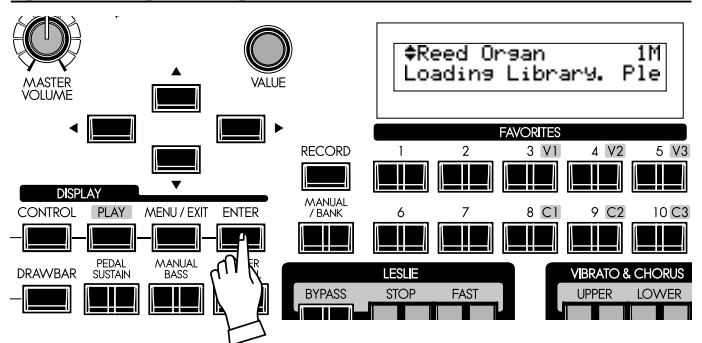

Press the [ENTER] button. Loading the Voice Library starts. It may take a while for this procedure to complete.

Required time for registration depends on the capacity. It takes a maximum of 30 minutes.

DELETE A VOICE LIBRARY

When the remaining capacity of the SKX is not enough for the Voice Library you want to load, you can increase the capacity by deleting an unnecessary portion of the library.

① LOCATE THE LIBRARY MODE

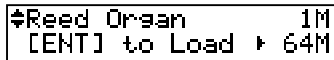

Locate the Voice Library function mode.

② SELECT THE OPERATION

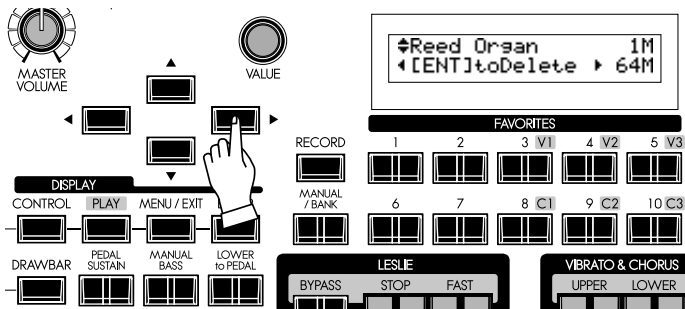

Press the [▶] button. The selected Library is displayed.

③ SELECT THE LIBRARY FILE

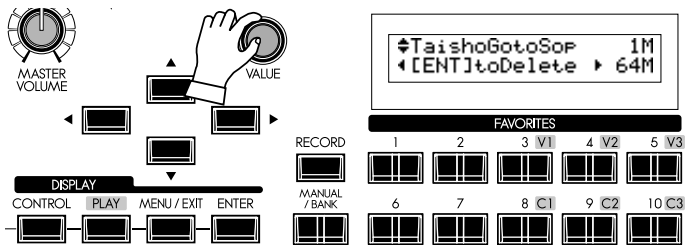

The Library's size is displayed on the upper right. Select the Voice Library you want to delete using either the [VALUE] knob or the [▲],[▼] buttons, referring to the display.

④ PRESS [ENTER] TO DELETE

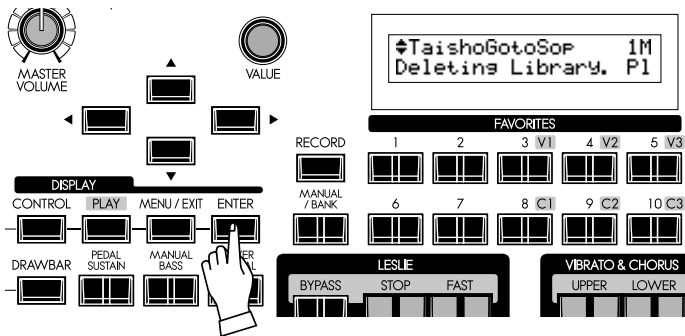

Press the [ENTER] button. The selected Voice Library is deleted from the memory, and the remaining capacity is displayed on the bottom right.

CLEAR ALL VOICE LIBRARIES

If you want to "start fresh" and load all new Voice Libraries, you can clear the entire Voice Library memory.

① LOCATE THE LIBRARY MODE

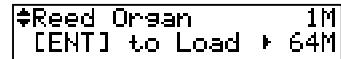

Locate the Voice Library function mode.

② SELECT THE OPERATION

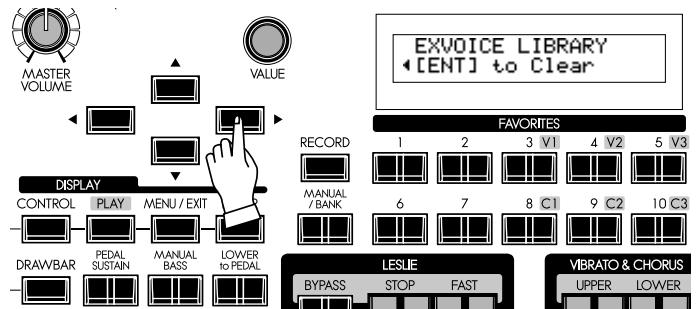

Press the [▶] button twice. 'Clear' page appears.

③ PRESS [ENTER] TO CONFIRM

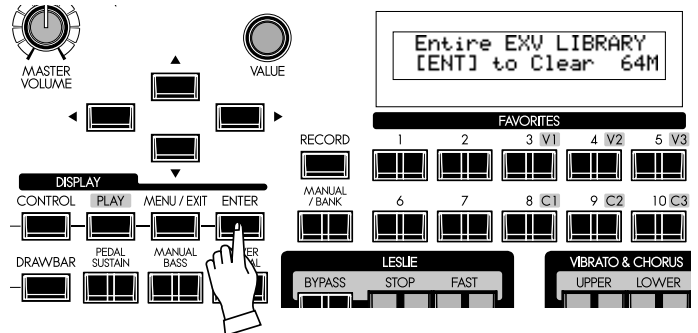

Press the [ENTER] button. You will see a message confirming that you want to delete all currently installed Voice Libraries.

④ PRESS [ENTER] TO CLEAR

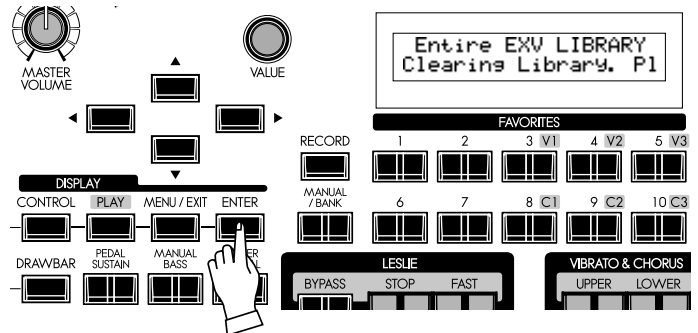

Press the [ENTER] button again. The Voice Library memory will be cleared.

If you do not wish to clear, touch the [MENU/EXIT] button.



Troubleshooting

- ◆ **Malfunction of the buttons, the keys, etc.**
 - ◆ Turn the POWER to instrument “OFF”, then turn it “ON” again. If this procedure is not successful, turn “OFF” the POWER switch. While pressing the [RECORD] button, turn the [POWER] switch “ON” again. (Note that in this case, all parameters return to their factory-preset status.)
- ◆ **No sound is produced when the keys are pressed.**
 - ◆ The MASTER VOLUME is at the minimum setting. ⇨
Adjust the volume with the MASTER VOLUME control.
 - ◆ The [UPPER ON] [LOWER ON] buttons are OFF. ⇨
Press the button to switch ON.
 - ◆ The [ORGAN VOLUME] [EXTRA VOICE VOLUME] are set at minimum. ⇨
Turn the knobs to adjust the volume of each section.
 - ◆ MIDI Local Control is OFF. ⇨
Turn the local control ON, if not using an external sequencer or computer. (P. 112)
 - ◆ A Leslie speaker is connected via Leslie receptacle. ⇨
Line Out and Phones jack do not carry the audio output the sound of Rotary channel (Organ section) when a Leslie speaker is connected.
- ◆ **Certain notes appear not to be playing.**
 - ◆ Only L/MONO is connected, but Audio Mode is set to “STEREO”. ⇨
Set the Audio Mode at “MONO”. (P. 102)
- ◆ **No change in Expression.**
 - ◆ The Expression Source assignment is not correctly set. ⇨
Correctly set the Expression Source item in the CONTROL mode. (P. 128)
 - ◆ The Expression mode of Overdrive is set at “OD Only” or “Input”. ⇨
Set the Expression mode at except “OD Only” or “Input”. (P. 90)
 - ◆ The Source of Multi-Effect is set at “EXP”. ⇨
Set the Source at a parameter other than “EXP”. (P. 91)
 - ◆ The “EXP” (Expression) parameter for the Extra Voice section at “OFF”. ⇨
Set the value at “ON”. (P. 75)
- ◆ **The Foot Switch does not work properly.**
 - ◆ The Foot Switch assignment is not correctly set. ⇨
Correctly set the Foot Switch in the CONTROL mode. (P. 76)
- ◆ **The Foot Switch or Damper Pedal are working “backwards” - the function is enabled when switch is released instead of depressed.**
 - ◆ Misjudged the Foot Switch or Damper Pedal by connecting their during power is “ON”. ⇨
Connect the Foot Switch and/or Damper Pedal, then turn the power to the SKX “ON”. The polarity of the switch(es) will be set automatically. Do not depress the switch(es) until the SKX is fully powered up: i.e., the PLAY mode screen is displayed.
- ◆ **The sound is interrupted briefly when changing Patches while notes are being held.**
 - ◆ If the following values are different between the Patches, there will be a brief interruption:
 - ◆ Organ Type
 - ◆ Extra Voice
 - ◆ Multi-Effects
 - ◆ Octave
 - ◆ Manual Bass
 - ◆ Key Range
- ◆ **The MIDI velocity can not control by playing velocity.**
 - ◆ The Sounding Point is set at AUTO. ⇨
Set the Sounding Point at DEEP. (P. 79)
- ◆ **The MENU/EXIT or RECORD buttons do not function.**
 - ◆ The Display Lock is enabled. ⇨
Disable the Display Lock (P. 70).
- ◆ **The OCTAVE buttons do not function.**
 - ◆ A function is assigned to the button. ⇨
Set the assign at ORIGIN. (P. 78).

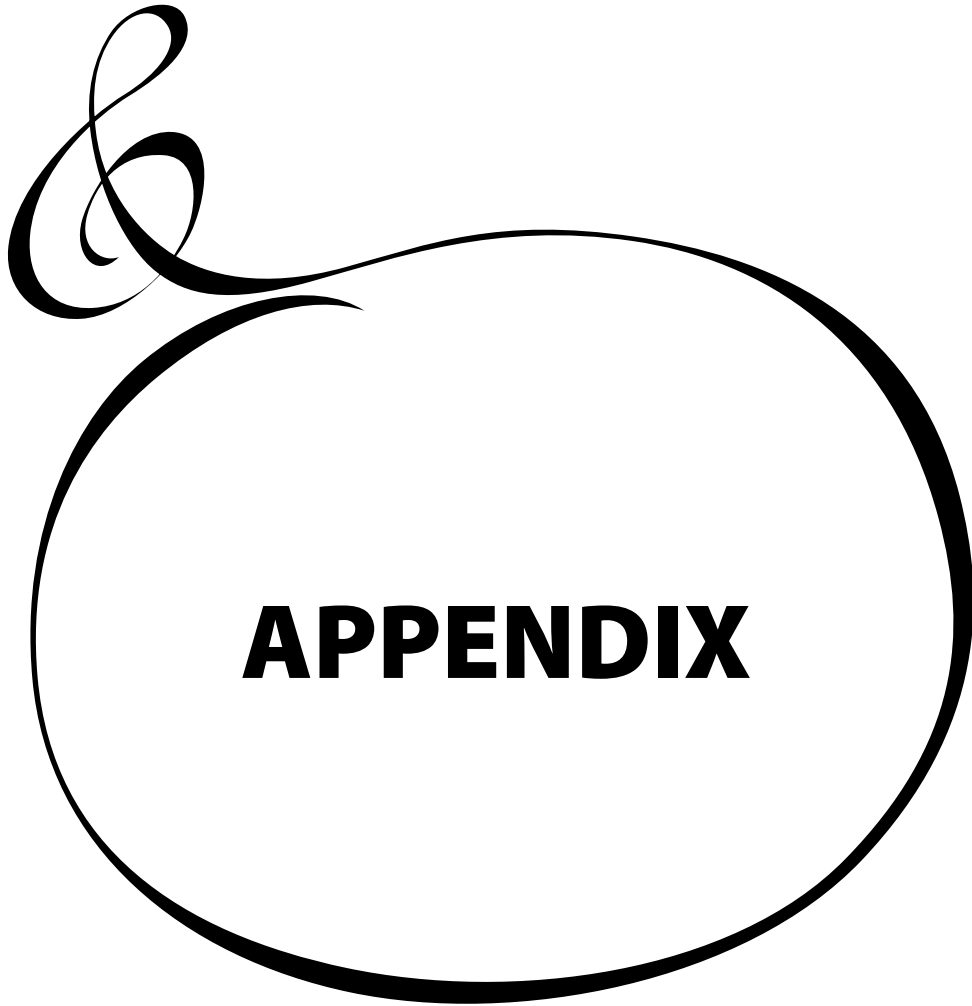

APPENDIX

EXTRA VOICE INSTRUMENT LIST

Group	Number	Description
0 A. Piano	0 Stereo Grand Pf.	Concert grand piano. The maximum sound effect is obtained when connected stereo.
0 A. Piano	1 Bright Stereo Grand Pf.	
0 A. Piano	2 Mono Grand Pf.	The mono version of above. Use this if connection is monaural. The annoying phase cancellation due to the combined left and right channels is avoided.
0 A. Piano	3 Bright Mono Grand Pf.	
0 A. Piano	4 Electric Grand Pf.	The 1970's "Solid Body" electric piano, which used true piano strings, grand piano action and magnetic pickups. The following "EQ" means equalized edition.
0 A. Piano	5 Electric Grand Pf. EQ	
1 E. Piano	0 E. Piano Rd1	Tone-bar electric piano (first edition). The following "Pan", "Phase", "OD" are using each effect.
1 E. Piano	1 EP Rd1 Pan	
1 E. Piano	2 EP Rd1 Phase	
1 E. Piano	3 EP Rd1 OD	
1 E. Piano	4 - 7 E. Piano Rd2, Pan, Phase, OD	Tone-bar electric piano (second edition). The following "Pan", "Phase", "OD" are using each effect.
1 E. Piano	8 E. Piano FM	FM synth electric piano. The following "Chorus" is using chorus effect.
1 E. Piano	9 EP FM Chorus	
1 E. Piano	10 E. Piano Wur	Reed-driven electric piano. The following "Trem" is using Tremolo, "OD" is using Overdrive effect.
1 E. Piano	11 EP Wur Trem	
1 E. Piano	12 EP Wur OD	
1 E. Piano	13 EPiano Bass	"E. Piano Rd2" for playing bass line.
1 E. Piano	14 EPiano Wur Mellow	Mellower setting of "E. Piano Wur".
1 E. Piano	15 EP FM Belly	Variation of the "E. Piano FM" with a "bell-like" (belly) tone.
2 Backing Str.	0 Synth Str. Fast Mellow	Synth. Strings with fast attack.
2 Backing Str.	1 Synth Str. Slow Mellow	Synth. Strings with slow attack.
2 Backing Str.	2 Synth Str. Fast Bright	Synth. Strings with fast attack and bright sound.
2 Backing Str.	3 Synth Str. Slow Bright	Synth. Strings with slow attack and bright sound.
2 Backing Str.	4 Synth Str. Octave	Synth. Strings with octave unison.
2 Backing Str.	5 Warm Pad	A "Pad" that mellower than the "Strings".
2 Backing Str.	6 Sweep and S/H	A "Pad" which modulates using LPF sweep and S/H effects.
2 Backing Str.	7 Pluck and Sweep	"Pluck" sound followed by sweeping Pad.
2 Backing Str.	8 Out Of The	Synth Lead with fat and bright sound.
3 Keyboard	0 Harpsi 8'	Harpsichord. "8'" is normal, "8' 4'" is in octave unison, "Lute" refers to damping the treble.
3 Keyboard	1 Harpsi 8' 4'	
3 Keyboard	2 Harpsi 8' Lute	
3 Keyboard	3 Clav. AC	Electric clavichord. "AC", "AD", "BC", "BD" indicate the pick-up selector.
3 Keyboard	4 Clav. AD	
3 Keyboard	5 Clav. BC	
3 Keyboard	6 Clav. BD	
3 Keyboard	7 - 10 Clav. AC, AD, BC, BD Wah	"Clav. AC" - "Clav. BD" with "Touch-Wah" effect. Filter opens wider as keys are struck harder.
3 Keyboard	11 - 14 Clav. AC, AD, BC, BD Cry	"Clav. AC" - "Clav. BD" with "Pedal Wah" effect. Use a connected Expression Pedal to add Wah-Wah effect.
3 Keyboard	15 Clavition	Left position of the keyboard sustains if the key is released, right position of the keyboard sounds a chord when a key is pressed.
3 Keyboard	16 Lucy	The sound of an early electronic keyboard as heard on "Lucy In The..."
3 Keyboard	17 Lucy Tremolo	
3 Keyboard	18 Clavn.	Simulates a 1950's monophonic keyboard instrument.
3 Keyboard	19 Don't Run	The reed sound like "Walk, Don't...".
3 Keyboard	20 Telstar	The sound of the pre-synthesizer instrument "Clavn." as heard on the song "Telstar".
3 Keyboard	21 Blue Star	Simulates an electronic organ as heard in "Blue Star".
3 Keyboard	22 - 32 Accordion A120 1/0/0, 1/1/0, 1/0/1, 1/1/1, 1/2/0, 1/2/1, 0/1/0, 0/2/0, 0/1/1, 0/2/1, 0/0/1	Variations of Suzuki accordion A-120.
3 Keyboard	33 Accordion A120 OD	Overdriven accordion.
3 Keyboard	34 Acdn Mellow 0/1/0	Mellow accordion. "MMM" is Musette accordion with adjustable detuning by [AMOUNT] knob of the Extra Voice effects.
3 Keyboard	35 Acdn Mellow 0/2/0	
3 Keyboard	36 Acdn Mellow MMM	
3 Keyboard	37 Acdn Bright 0/1/0	Bright accordion.
3 Keyboard	38 Acdn Bright 0/2/0	
3 Keyboard	39 Acdn Bright MMM	
3 Keyboard	40 Doob Real Love	"Clav. AD" with added Overdrive and Phaser effects.
4 Wind	0 Trumpet Straight	Trumpet. "Straight", "Vibrato" and "Muted" indicate variations.
4 Wind	1 Trumpet Vibrato	
4 Wind	2 Trumpet Muted	
4 Wind	3 Trombone Straight	Trombone. "Straight", "Muted" indicate variations.
4 Wind	4 Trombone Muted	
4 Wind	5 Flute Vibrato	Flute with Vibrato. A harder attack will be produced by a faster key stroke.
4 Wind	6 Al. Sax Straight	Alto Saxophone. "Straight", "Vibrato" indicate variations.
4 Wind	7 Al. Sax Vibrato	
4 Wind	8 Tn. Sax Straight	Tenor Saxophone. "Straight", "Vibrato" indicate variations.
4 Wind	9 Tn. Sax Vibrato	
4 Wind	10 Ba. Sax Straight	Baritone Saxophone.

Group	Number	Description
4 Wind	11 Tp + Tb Straight	Trumpet and trombone playing in octave unison. "Straight", "Vibrato" indicate variation.
4 Wind	12 Tp + Tb Vibrato	
4 Wind	13 Tp + Tb Muted	
4 Wind	14 Flute Pcd	A Flute section. A melody with harmony is heard if a single note is played on the Upper keyboard while holding notes on the Lower keyboard.
4 Wind	15 BigBand Sax Pcd	A Big Band Saxophone section. Alto sax as the top note, tenor sax, baritone sax as the harmony notes if a single note is played on the Upper keyboard while holding notes on the Lower keyboard.
4 Wind	16 BigBand Pcd	A Big Band Brass. Trumpet as the top note, alto sax, trombone and tenor sax as the harmony notes if a single note is played on the Upper keyboard while holding notes on the Lower keyboard.
4 Wind	17 BigBand FD Pcd	
4 Wind	18 Quartet 1 Pcd	Instrumentation is same as "Big Band Pcd", but with different harmony voicing.
4 Wind	19 Quartet 2 Pcd	Instrumentation is same as "Big Band Pcd", but with different harmony voicing.
4 Wind	20 Jazz Brass Pcd	A modern Big Band Brass section. Trumpet as the top note, trumpet, trombone as the harmony notes if a single note is played on the Upper keyboard while holding notes on the Lower keyboard. "FD" means fall-down when played with fortissimo and released.
4 Wind	21 Jazz Brass FD Pcd	
4 Wind	22 Mute Combo 1 Pcd	The Brass Combo with muted trumpets and straight trombone. 3-part harmony is heard if a single note is played on the Upper keyboard while holding notes on the Lower keyboard.
4 Wind	23 Mute Combo 2 Pcd	The Brass Combo with muted trumpets and muted trombone. 3-part harmony is heard if a single note is played on the Upper keyboard while holding notes on the Lower keyboard.
4 Wind	24 BigBand Gliss Up Pcd	Variation of "BigBand Pcd". Glissandos "up" when the played fortissimo and released.
4 Wind	25 Two Trumpets	Two trumpets in unison.
4 Wind	26 Unison Brass	Octave unison of trumpet, alto sax, trombone and tenor sax.
4 Wind	27 Synth Brass Afri	Mellow synth brass similar to "Afri...".
4 Wind	28 Synth Brass Rosa	Bright synth brass similar to "Rosa...".
5 Other	0 Glockenspiel	Orchestra bells or glockenspiel, effective if used with Drawbar sounds.
5 Other	1 Vibraphone	Hard hit vibraphone. Also effective if used with Drawbar sounds.
5 Other	2 Solly Strings	Late 1970's strings ensemble keyboard. "o" indicates octave unison, "Long" indicates longer release rate.
5 Other	3 Solly Strings o	
5 Other	4 Solly Strings Long	
5 Other	5 Solly Strings o Long	
5 Other	6 Syn. Strings 1	Simulates the strings keyboard via multi-effects. "o" indicates octave unison.
5 Other	7 Syn. Strings 1 o	
5 Other	8 Syn. Strings 2	Synthesized strings sounds. Simulates the strings of the Hammond SX/CX series.
5 Other	9 Syn. Strings 2 o	
5 Other	10 Syn. Strings 3	Synthesized strings sounds. Using 3 sawtooth waveforms.
5 Other	11 Sweep Pad	Synth pad with slow filter sweep. "Slice" adds the deep tremolo effect.
5 Other	12 Slice Pad	
5 Other	13 H. Bell Pad	Synth pad with Hand Bells.
5 Other	14 Glock. Pad	Synth pad with Glockenspiel.
5 Other	15 Square Lead	Synth lead using Square wave.
5 Other	16 Square Mellow	Synth lead, mellower than "Square Lead".
5 Other	17 Saw Lead	Synth lead using Sawtooth wave. "Duo Pcd" adds ProChord function, providing two-part harmony if a single note is played on the Upper keyboard while holding notes on the Lower keyboard. The "Block Pcd" also has ProChord harmony providing "Block" voicing.
5 Other	18 Saw Duo Pcd	
5 Other	19 Saw Block Pcd	
5 Other	20 P. O. Love	"Saw Lead" in octave unison. Effective playing either single notes or chords, as in "The Power Of...".
5 Other	21 Funny Lead	Simulates the "green button" of a late 70's Japanese combo organ. "Duo Pcd" adds ProChord function, providing two-part harmony if a single note is played on the Upper keyboard while holding notes on the Lower keyboard.
5 Other	22 Funny Duo Pcd	
5 Other	23 Syn. Harp	Synth orchestral harp.
5 Other	24 Noise Zap	An unpitched sound effect made up of white noise and an LPF.
5 Other	25 Finger Bs Jz	"Jazz" type electric bass, played by forefinger.
5 Other	26 Pick Bs Jz	"Jazz" type electric bass, played by the pick with muted.
5 Other	27 Pick Lng Bs Jz	Same as above with longer decay.
5 Other	28 Slap Bs Jz	"Jazz" type electric bass, played with slap style.
6 Library	0 VxJ Bright	1960's "Vx" transistor combo organ. This organ used Tablets instead of the Drawbars. It had a single tone, and the tabs varied the brightness. "Bright" is the brightest.
6 Library	1 VxJ Brass	
6 Library	2 VxJ Mellow	
6 Library	3 VxJ Flute	
6 Library	4 - 7 VxJV Bright, Brass, Mellow, Flute	"VxJ" with vibrato.
6 Library	8 - 11 VxJS Bright, Brass, Mellow, Flute	"VxJ" with sustain.

Example Select Group 2, Number 3 via NRPNBx 63 06 62 50 06 02 26 00 63 07 62 50 06 03 26 00 (x = Upper channel)

PRESET PATCH LIST

Category	#	Name
High Lights	P001	Vintage B-3 DLS
	P002	Crunch B-3
	P003	Squabble
	P004	Hugger
	P005	Classic B-3
	P006	Ste Grand Piano
	P007	Piano&Strings
	P008	Tine E-Piano
	P009	Reed E-Piano
	P010	Clav (BD)
B-3 Organ	P011	Vintage B-3 JOS
	P012	Vintage B-3 McG
	P013	Vintage B-3 Grv
	P014	VintageB-3Burnr
	P015	VintageB-3Shrly
	P016	Vintage B-3 Bop
	P017	VintageB-3Balad
	P018	B-3 & E Pno Phs
	P019	VintageB-3Waltr
	P020	Full Spin
A / E Piano	P021	Grand Piano
	P022	Road's Suitcase
	P023	Road's Stage
	P024	Wurlli E Piano
	P025	Clav AC&BC
	P026	Clav AC&BC Wah
	P027	CP70 Elec Grand
	P028	GrndPno/Strings
	P029	FM EPno/Strings
	P030	FM El Pno Belly
Wind	P031	Solo Flute
	P032	Solo A.Sax
	P033	Solo T.Sax
	P034	Solo Trumpet
	P035	Tp & Tb
	P036	Pcd Flute Sect
	P037	Pcd Sax Sect.
	P038	Pcd Jazz Brass
	P039	Pcd Muted Combo
	P040	Pcd Syn Block
Pipe Organ	P041	Pianissimo
	P042	Piano
	P043	Mezzo Piano
	P044	Mezzo Forte
	P045	Forte
	P046	Fortissimo
	P047	Reed Solo
	P048	Sforzando
	P049	A.Pf / Positiv
	P050	Hrpsi / Positiv

Category	#	Name
Gospel Organ	P051	Classic Gospel
	P052	Slow Gospel
	P053	Contemp.Gospel
	P054	Shout Gospel
	P055	Quiet Praise
	P056	Reflectiv Praise
	P057	Dramatic Praise
	P058	Total Praise
	P059	Meditation
	P060	Full Gospel
Theater / Pop / Accor-dion	P061	Thtr Tibias 8&4
	P062	Thtr Tibias16&4
	P063	OrcOboe8&Tibia4
	P064	Pop Organ
	P065	PopOrgn&Strings
	P066	Accordion Clasc
	P067	Accordion Jazz
	P068	Accordion Zydco
	P069	Acrd Basoon&Pic
	P070	Acordion French
Others	P071	VxCombOrg/PnoBs
	P072	Neon Shuf
	P073	Runaway
	P074	Enka Lead
	P075	Tornado
	P076	Fake Arpegiator
	P077	Sleng Teng
	P078	Slice Pad
	P079	Ring Heaven
	P080	1960's Sci-Fi
With Bass	P081	GdPnoOrgan&Bass
	P082	ElPnoOrgan&Bass
	P083	VibesOrgan&Bass
	P084	TnSaxOrgan&Bass
	P085	TrptsOrgan&Bass
	P086	ElGrdOrgan&Bass
	P087	FMEPnOrgan&Bass
	P088	RdPnoOrgan&Bass
	P089	WahClOrgan&Bass
	P090	BrassOrgan&Bass
B-3 OEM Preset	P091	B-3 OEM C#Pkeys
	P092	B-3 OEM D Pkeys
	P093	B-3 OEM D#Pkeys
	P094	B-3 OEM E Pkeys
	P095	B-3 OEM F Pkeys
	P096	B-3 OEM F#Pkeys
	P097	B-3 OEM G Pkeys
	P098	B-3 OEM G#Pkeys
	P099	B-3 OEM A Pkeys
	P100	FullTheatrOrgn

MIDI TEMPLATES

Template		Basic	Pedal KBD	Use Ex. Zone
Messages	MIDI IN	Sequence	Pedal	Sequence
	Local Control	On	On	On
	NRPN	On	On	On
	Program Change	On	On	On
	Drawbar Registration	On	On	On
Transmit Channel	Tx. Upper	1	1	Off
	Tx. Lower	2	2	Off
	Tx. Pedal	3	3	Off
	Rx. Upper	1	1 (disregarded, off)	Off
	Rx. Lower	2	2 (disregarded, off)	Off
	Rx. Pedal	3	3 (disregarded, omni)	Off
	External Zone	Off	Off	On
Comments		Use this template to record/playback the performance of only SKX to the external sequencer.	Use this template to play on the Pedal keyboard connecting to the MIDI IN jack.	Use this template to play only on the SKX and control the MIDI equipment connected to the MIDI OUT jack with the External Zone.

Template		Use Ex. w/PK
Messages	MIDI IN	Pedal
	Local Control	On
	NRPN	On
	Program Change	On
	Drawbar Registration	On
Transmit Channel	Tx. Upper	Off
	Tx. Lower	Off
	Tx. Pedal	Off
	Rx. Upper	1 (disregarded, off)
	Rx. Lower	2 (disregarded, off)
	Rx. Pedal	3 (disregarded, omni)
	External Zone	On
Comments		Use this template to play on the SKX and the Pedalboard connected to the MIDI IN jack and control the MIDI equipment connected to the MIDI OUT jack with the External Zone.

MIDI Implementation

Channel Voice Message

Note Off

Status	2nd Byte	3rd Byte
8nH	kkH	vvH, or
9nH	kkH	00H
n=MIDI Channel Number:	0H - FH (Ch. 1 - 16)	
kk=Note Number:	00H - 7FH (0 - 127)	
vv=Velocity(disregard):	00H - 7FH (0 - 127)	

Note On

Status	2nd Byte	3rd Byte
9nH	kkH	vvH
n=MIDI Channel Number:	0H - FH (Ch. 1 - 16)	
kk=Note Number:	00H - 7FH (0 - 127)	
vv=Velocity:	00H - 7FH (0 - 127)	

Control Change

Bank Select (CC#0, 32)

Status	2nd Byte	3rd Byte
BnH	00H	mmH
BnH	20H	llH
n=MIDI Channel Number:	0H - FH (Ch. 1 - 16)	
mm,ll=Bank Number:	00H 00H = User 01H 00H = Preset 64H 00H - 6DH 00H = Bank [1] to [10]	

Until you send the Program Change, the Bank Select process is reserved.

Expression (CC#11)

Status	2nd Byte	3rd Byte
BnH	0BH	vvH
n=MIDI Channel Number:	0H - FH (Ch. 1 - 16)	
vv=Expression:	00H - 7FH (0 - 127)	

Spring Shock (CC#48)

Status	2nd Byte	3rd Byte
BnH	30H	vvH
n=MIDI Channel Number:	0H - FH (Ch. 1 - 16)	
vv=Velocity:	00H - 7FH (0 - 127)	

Glide (CC#49)

Status	2nd Byte	3rd Byte
BnH	31H	vvH
n=MIDI Channel Number:	0H - FH (Ch. 1 - 16)	
vv=Control Value:	00H - 7FH (0 - 127) 0 - 63=Off, 64 - 127=On	

Damper (CC#64)

Status	2nd Byte	3rd Byte
BnH	40H	vvH
n=MIDI Channel Number:	0H - FH (Ch. 1 - 16)	
vv=Control Value:	00H - 7FH (0 - 127) 0 - 63=Off, 64 - 127=On	

ProChord Active (CC#84)

Status	2nd Byte	3rd Byte
BnH	54H	vvH
n=MIDI Channel Number:	0H - FH (Ch. 1 - 16)	
vv=Control Value:	00H - 7FH (0 - 127) 0 - 63=Off, 64 - 127=On	

Activates "Harmony" parts for Organ section during this parameter is "On".

Drawbar Priority (CC#85, 86)

Status	2nd Byte	3rd Byte
BnH	5kH	vvH
k=Drawbar Group:	5 = Upper, 6=Lower	
n=MIDI Channel Number:	0H - FH (Ch. 1 - 16)	
vv=Control Value:	00H - 7FH (0 - 127) 0 - 63=Off, 64 - 127=On	

Leslie Fast (CC#92)

Status	2nd Byte	3rd Byte
BnH	5CH	vvH
n=MIDI Channel Number:	0H - FH (Ch. 1 - 16)	
vv=Control Value:	00H - 7FH (0 - 127) 0 - 63=Off, 64 - 127=On	

This control change is only for receive.

NRPN MSB/LSB (CC#98, 99)

Status	2nd Byte	3rd Byte
BnH	63H	mmH
BnH	62H	llH
n=MIDI Channel Number:	0H - FH (Ch. 1 - 16)	
mm=upper byte of the parameter number specified by NRPN		
ll=lower byte of the parameter number specified by NRPN		

Data Entry (CC#6, 38)

Status	2nd Byte	3rd Byte
BnH	06H	mmH
BnH	26H	llH
n=MIDI Channel Number:	0H - FH (Ch. 1 - 16)	
mm,ll=the value of the parameter specified by NRPN		

Program Change

Status	2nd Byte
CnH	ppH
n=MIDI Channel Number:	0H - FH (Ch. 1 - 16)
pp=Program Number:	00H - 63H = Patch #0 to 99 64H - 6DH = Favo. Number [1] to [10] 7FH = [Manual]

Example of operation

ex: select Patch P016

Bx 00 01 Bx 20 00 Cx 0F (x=Upper Channel)

ex: select Favorite Bank[2], Number[6]

Bx 00 65 Bx 20 00 Cx 69 (x=Upper Channel)

ex: select Manual

Cx 7F (x=Upper Channel)

Channel Mode Message

All Sounds Off (CC#120)

Status	2nd Byte	3rd Byte
BnH	78H	00H
n=MIDI Channel Number:	0H - FH (Ch. 1 - 16)	

When this message is received, all currently-sounding notes on the corresponding channel will be turned off immediately.

Reset All Controllers (CC#121)

Status	2nd Byte	3rd Byte
BnH	79H	00H
n=MIDI Channel Number:	0H - FH (Ch. 1 - 16)	

When this message is received, the following controllers will be set to their reset values.

Expression:	127
Glide:	0
Damper:	0
NRPN:	unset; previously set data will not change

All Notes Off (CC#123)

Status	2nd Byte	3rd Byte
BnH	7BH	00H
n=MIDI Channel Number:	0H - FH (Ch. 1 - 16)	

When All Notes Off is received, all notes on the corresponding channel will be turned off. However if Hold 1 or Sostenuuto is ON, the sound will be continued until these are turned off.

Drawbar Data List 1

Control Number

Upper: 50H(80)
 Lower: 51H(81)
 Pedal: 52H(82)

Level	Upper / Lower									Pedal	
	16'	5 1/3'	8'	4'	2 2/3'	2'	1 3/5'	1 1/3'	1'	16'	8'
0	00H(0)	09H(9)	12H(18)	1BH(27)	24H(36)	2DH(45)	36H(54)	3FH(63)	48H(72)	00H(0)	09H(9)
1	01H(1)	0AH(10)	13H(19)	1CH(28)	25H(37)	2EH(46)	37H(55)	40H(64)	49H(73)	01H(1)	0AH(10)
2	02H(2)	0BH(11)	14H(20)	1DH(29)	26H(38)	2FH(47)	38H(56)	41H(65)	4AH(74)	02H(2)	0BH(11)
3	03H(3)	0CH(12)	15H(21)	1EH(30)	27H(39)	30H(48)	39H(57)	42H(66)	4BH(75)	03H(3)	0CH(12)
4	04H(4)	0DH(13)	16H(22)	1FH(31)	28H(40)	31H(49)	3AH(58)	43H(67)	4CH(76)	04H(4)	0DH(13)
5	05H(5)	0EH(14)	17H(23)	20H(32)	29H(41)	32H(50)	3BH(59)	44H(68)	4DH(77)	05H(5)	0EH(14)
6	06H(6)	0FH(15)	18H(24)	21H(33)	2AH(42)	33H(51)	3CH(60)	45H(69)	4EH(78)	06H(6)	0FH(15)
7	07H(7)	10H(16)	19H(25)	22H(34)	2BH(43)	34H(52)	3DH(61)	46H(70)	4FH(79)	07H(7)	10H(16)
8	08H(8)	11H(17)	1AH(26)	23H(35)	2CH(44)	35H(53)	3EH(62)	47H(71)	50H(80)	08H(8)	11H(17)

ex: Set Lower 8' to level 7 via MIDI... Bx 51 19 (x=Lower Channel)

Drawbar Data List 2

Part	Control Number								
	16'	5 1/3'	8'	4'	2 2/3'	2'	1 3/5'	1 1/3'	1'
Upper	0CH(12)	0DH(13)	0EH(14)	0FH(15)	10H(16)	11H(17)	12H(18)	13H(19)	14H(20)
Lower	15H(21)	16H(22)	17H(23)	18H(24)	19H(25)	1AH(26)	1BH(27)	1CH(28)	1DH(29)
Pedal	21H(33)	-	23H(35)	-	-	-	-	-	-

Value	Level								
	0	1	2	3	4	5	6	7	8
00 - 0FH (0 - 15)	10 - 1FH (16 - 31)	20 - 2FH (32 - 47)	30 - 3FH (48 - 63)	40 - 4FH (64 - 79)	50 - 5FH (80 - 95)	60 - 6FH (96 - 111)	70 - 7EH (112-126)	7FH (127)	

ex: Set Lower 8' to level 7 via MIDI... Bx 17 70 (x=Upper Channel)

System Exclusive Message

◆ Memory Dump

1. Each Packet

F0	System Exclusive
55	SUZUKI ID
dd	Device ID (refer to P. 112)
10	Model ID MSB
23	Model ID LSB
11	Command: Data Packet
[TYPE]	Data Type 02H = All Data Dump 07H = Combi. Temp. Dump 09H = Global Dump 0AH = System Dump
[PNH]	Packet Number MSB
[PNL]	Packet Number LSB
[DATA]	128 Bytes Data 256 Bytes nibblized ASCII ex: 7EH = 37H, 45H
[CHD]	Check Digit Lower 7 bits of XOR [DATA]
F7	End Of Exclusive

2. Acknowledge

F0	System Exclusive
55	SUZUKI ID
dd	Device ID
10	Model ID MSB
23	Model ID LSB
14	Command: Acknowledge
[TYPE]	Data Type
[AK]	Result 00H = OK 05H = Check Digit Error 06H = Receive Protected
[PNH]	Packet Number MSB
[PNL]	Packet Number LSB
F7	End Of Exclusive

3. # of Packets

All Data Dump:	505
Combi. Temp Dump:	27
Global Dump:	10
System Dump:	1

◆ Dump Request (Rx. only)

F0	System Exclusive
55	SUZUKI ID
dd	Device ID
10	Model ID MSB
23	Model ID LSB
12	Command: Dump Request
[TYPE]	Data Type 02H = All Data Dump 07H = Combi. Temp. Dump 09H = Global Dump 0AH = System Dump
F7	End Of Exclusive

Mode Setting Exclusive Message

Full Parameters Reset (Rx. only)

F0	System Exclusive
55	SUZUKI ID
dd	Device ID
42	Mode ID for DT1
12	Command: DT1
40	Address MSB
00	Address
7F	Address LSB
7F	Reset
42	Check Sum
F7	End Of Exclusive

NRPN Switch

F0	Suzuki Exclusive
55	SUZUKI ID
dd	Device ID
10	Model ID MSB
23	Model ID LSB
02	Command: NRPN Sw.
[DATA]	00H = Off, 7FH = On
F7	End Of Exclusive

When this device receives this message, switch Tx & Rx NRPN in Control channel.

Data Set (Rx. only)

F0	System Exclusive
55	SUZUKI ID
dd	Device ID
10	Model ID MSB
23	Model ID LSB
13	Command: Data Set
aa	Address MSB
bb	Address
cc	Address LSB
[DATA]	Data (Flexible bytes)
F7	End Of Exclusive

Identity Request (Rx. only)

F0	System Exclusive
7E	Universal non real-time
dd	Device ID
06	Sub ID #1
01	Sub ID #2
F7	End Of Exclusive

Identity Reply (Tx. only)

F0	System Exclusive
7E	Universal non real-time
dd	Device ID
06	Sub ID #1
02	Sub ID #2
55	SUZUKI ID
00 10	Device Family code
00 23	Device Family number
00 00	
00 00	
F7	End Of Exclusive

When Identity Request is received, Identity Reply will be transmitted.

Global Parameters

Category	Parameter	NRPN		SysEx Address			SysEx Length	Data	Default	Description	
		LSB (62)	MSB (63)	MSB to LSB							
Tune	Transpose	01	00	00	01	00	01	3A - 40 - 46 (-6 - 0 - +6)	40	0	
	Master Tune	01	02	00	01	02	02	032E - 0338 - 0342 (430 - 440 - 450)	0338	440	
Expression	Source	02	00	00	02	00	01	00 - 04 00: Pedal (normal) 01: Pedal (reverse) 02: MIDI 03: Both (normal) 04: Both (reverse)	00	Pedal (normal)	
	Min. Level	02	08	00	02	08	01	00 - 09 (Off, -40dB - 0dB)	06	-35dB	
	Min. Limit LF	02	09	00	02	09	01	00 - 08	05	-20dB	
	Min. Limit HF	02	0A	00	02	0A	01	(Off, -40dB - -5dB)	03	-30dB	
Foot Switch	FS Device	03	00	00	03	00	01	00 - 01 (Foot Sw., Leslie Sw.)	00	Foot Sw.	
	FS Tip Mode	03	01	00	03	01	01	00 - 27 00: Off 01: Leslie Fast (alternate) 02: Leslie Fast (momentarily) 03: Leslie Fast (tri-state) 04: Glide 05: Patch Fwd. 06: Patch Back 07: Favorite Fwd. 08: Favorite Back 09: Spring Shock 0A: Delay Time 0B: Music Start 0C: Manual Bass 0D - 25: Bass 1C - 3C 26: Prochord Close 27: Prochord Open	01	Leslie Fast (alternate)	
	FS Ring Mode	03	02	00	03	02	01	same as FS Tip mode	01	Leslie Fast (alternate)	
	Damper Org. Upper	03	03	00	03	03	01	00, 01 (Off/On)	01	On	
	Damper Org. Lower	03	04	00	03	04	01	00, 01 (Off/On)	01	On	
	Damper Org. Pedal	03	05	00	03	05	01	00, 01 (Off/On)	01	On	
	Damper Extra Voice 1	03	06	00	03	06	01	00, 01 (Off/On)	01	On	
	Damper Extra Voice 2	03	10	00	03	10	01	00, 01 (Off/On)	01	On	
	Panel Switch	Octave Down Mode	03	07	00	03	07	01	00 - 09 00: Origin 01: Leslie Stop 02: Leslie Fast 03: Vibrato Upper 04: Vibrato Lower 05: Glide 06: Spring Shock 07: Delay Time 08: Prio. Drawbars Upper 09: Prio. Drawbars Lower	00	Origin
		Octave Up Mode	03	08	00	03	08	01	same as above	00	Origin
Octave Lower Mode		03	09	00	03	09	01	same as above	00	Origin	
Patch Load		Drawbar Registration Upper	60	00	00	60	00	01	00, 01 (Off/On)	01	On
	Drawbar Registration Lower	60	01	00	60	01	01	00, 01 (Off/On)	01	On	
	Drawbar Registration Pedal	60	02	00	60	02	01	00, 01 (Off/On)	01	On	
	Drawbar Parameters (DRAWB)	60	03	00	60	03	01	00, 01 (Off/On)	01	On	
	Extra Voice (EXV)	60	04	00	60	04	01	00, 01 (Off/On)	01	On	
	Internal Zone (INT)	60	05	00	60	05	01	00, 01 (Off/On)	01	On	
	External Zone (EXT)	60	06	00	60	06	01	00, 01 (Off/On)	01	On	
	Organ Effect (DRAWB)	60	07	00	60	07	01	00, 01 (Off/On)	01	On	
	Extra Voice Effect (EXV)	60	08	00	60	08	01	00, 01 (Off/On)	01	On	
	Reverb (REV)	60	09	00	60	09	01	00, 01 (Off/On)	01	On	
Animation (ANI)	60	0A	00	60	0A	01	00, 01 (Off/On)	01	On		
Favorites	Access	04	00	00	04	00	01	00 - 03 00: Associate 01: Overwrite 02: Locked 1-10 03: Direct	00	Associate	
Display	Short Cut	--	--	--	--	--	--	0, 1, 2s, No		1	
	Time Out	--	--	--	--	--	--	4, 8, 16s, No		No	
	Pop Up	--	--	--	--	--	--	No, 0.5, 1, 2s		1	
	Part On Mode	--	--	--	--	--	--	Additive, Alternate		Additive, Alternate	
Master EQ	Bass Gain	03	0A	00	03	0A	01	00 - 09 - 12 (-9 - 0 - +9dB)	09	0dB	
	Mid Gain	03	0B	00	03	0B	01	00 - 09 - 12 (-9 - 0 - +9dB)	09	0dB	
	Treble Gain	03	0C	00	03	0C	01	00 - 09 - 12 (-9 - 0 - +9dB)	09	0dB	
	Bass Frequency	03	0D	00	03	0D	01	00 - 0A (20 - 200Hz)	07	100Hz	
	Mid Frequency	03	0E	00	03	0E	01	00 - 0A (250 - 3.1k Hz)	07	1.2kHz	
Treble Frequency	03	0F	00	03	0F	01	00 - 03 (4.0k - 8.0kHz)	03	8.0kHz		

Example Set Transpose at 0 via NRPNBx 62 01 63 00 06 40 (x = Upper channel)
 Set Transpose at 0 via System Exclusive.....F0 55 dd 10 23 13 00 01 00 40 F7 (dd = Device ID)

Patch Parameters

Category	Parameter	NRPN		SysEx Address			SysEx Length	Data	Patch Load
		LSB (62)	MSB (63)	MSB to LSB					
Name	15 Characters	--	--	01	00	00	0F	7 bit ASCII	always
Internal Zone	Manual Bass	07	00	00	07	00	01	00, 01 (Off/On)	INT
	Manual Bass Mode	07	01	00	07	01	01	00 - 02 (Lower, Chord, Poly)	
	Manual Bass Range Hi	07	02	00	07	02	01	24 - 60 (MIDI note number)	
	Great To Pedal	07	03	00	07	03	01	00, 01 (Off/On)	
	G to P Range Hi	07	04	00	07	04	01	24 - 3C (MIDI note number)	
	Split	07	05	00	07	05	01	00, 01 (Off/On)	
	Split Point	07	06	00	07	06	01	24 - 60 (MIDI note number)	
	Key Octave Upper 1	07	07	00	07	07	01	3E - 40 - 42 (-2 - 0 - +2)	
	Key Octave Lower 1	07	08	00	07	08	01	3E - 40 - 42 (-2 - 0 - +2)	
	Glide Length	07	09	00	07	09	01	00 - 18 (0 - 24 semitones)	
	Glide Time Attack	07	0A	00	07	0A	01	00 - 31 (0.1 - 5.0 seconds)	
	Glide Time Release	07	0B	00	07	0B	01	00 - 31 (0.1 - 5.0 seconds)	
	Glide Amp	07	0C	00	07	0C	01	00, 01 (Off/On)	
	Glide On Org	07	0D	00	07	0D	01	00, 01 (Off/On)	
	Glide On EXV1	07	0E	00	07	0E	01	00, 01 (Off/On)	
	Glide On EXV2	07	0F	00	07	0F	01	00, 01 (Off/On)	
Key Octave Upper 2	07	10	00	07	10	01	3E - 40 - 42 (-2 - 0 - +2)		
Key Octave Lower 2	07	11	00	07	11	01	3E - 40 - 42 (-2 - 0 - +2)		
External Zone	MIDI Channel	4n	00	00	4n	00	01	00 - 0F (1 - 16)	EXT
	Switch	4n	01	00	4n	01	01	00, 01 (Off/On)	
	Allocate	4n	02	00	4n	02	01	00 - 03 00: Off 01: Upper 02: Lower 03: Pedal	
	Key Range Lo	4n	03	00	4n	03	01	00 - 7F (MIDI note number)	
	Key Range Hi	4n	04	00	4n	04	01	00 - 7F (MIDI note number)	
	Bank Select MSB	4n	05	00	4n	05	01	00 - 7F	
	Bank Select LSB	4n	06	00	4n	06	01	00 - 7F	
	Program Change	4n	07	00	4n	07	01	00 - 7F	
	Octave Shift	4n	08	00	4n	08	01	3E - 40 - 42 (-2 - 0 - +2)	
	Volume	4n	09	00	4n	09	01	00 - 7F	
	Pan	4n	0A	00	4n	0A	01	00 - 40 - 7F (L64 - C - R63)	
	Velocity	4n	0B	00	4n	0B	01	00 - 04 (Off, Normal - Easy)	
	Expression Minimum	4n	0C	00	4n	0C	01	00 - 3F (0 - 63)	
	Expression Maximum	4n	0D	00	4n	0D	01	40 - 7F (64 - 127)	
Expression CC#	4n	0E	00	4n	0E	01	00, 01 (7, 11)		
Tx. Damper On	4n	0F	00	4n	0F	01	00, 01 (Off/On)		
Extra Voice	Switch Upper	5n	00	00	50	00	01	00, 01 (Off/On)	EXV
	Switch Lower	5n	01	00	50	01	01	00, 01 (Off/On)	
	Octave Shift	5n	03	00	50	03	01	3E - 40 - 42 (-2 - 0 - +2)	
	Key Range Lo	5n	04	00	50	04	01	00 - 7F (MIDI note number)	
	Key Range Hi	5n	05	00	50	05	01	00 - 7F (MIDI note number)	
	Inst. Group	5n	06	00	50	06	01	00 - 06 (1 - 7)	
	Inst. Number	5n	07	00	50	07	01	00 - 7F (1 - 128)	
	Volume	50	08	00	50	08	01	00 - 7F (0 - 127)	
	Balance	51	08	00	50	08	01	00 - 40 - 7F (64:0 - Even - 0:63)	
	Velocity	5n	09	00	50	09	01	00 - 04 (Off, Normal - Easy)	
Expression	50	0A	00	50	0A	01	00, 01 (Off/On)		

Example "n" means Zone number. 1=0, 2=1, 3=2
 Turn Extra Voice On via NRPNBx 62 50 63 00 06 01 (x = Upper channel)
 Turn Extra Voice On via System ExclusiveF0 55 dd 10 23 13 00 50 00 01 F7 (dd = Device ID)

Category	Parameter	NRPN		SysEx Address			SysEx Length	Data	Patch Load
		LSB (62)	MSB (63)	MSB to LSB					
Percussion	Percussion On	08	00	00	08	00	01	00, 01 (Off/On)	DRAWB
	Third On	08	01	00	08	01	01	00, 01 (Off/On)	
	Decay Fast	08	02	00	08	02	01	00, 01 (Off/On)	
	Volume Soft	08	03	00	08	03	01	00, 01 (Off/On)	
	Level On Soft	08	04	00	08	04	01	00 - 0F (1 - 16)	
	Level On Normal	08	05	00	08	05	01	00 - 0F (1 - 16)	
	Decay Fast	08	06	00	08	06	01	00 - 09 (1 - 9, Cont)	
	Decay Slow	08	07	00	08	07	01	00 - 09 (1 - 9, Cont)	
	Touch	08	08	00	08	08	01	00, 01 (Off/On)	
	Velocity	08	09	00	08	09	01	00, 01 (Off/On)	
	Key Track	08	0A	00	08	0A	01	00, 01 (Off/On)	
	Drawbar 1' Cancel	08	0B	00	08	0B	01	00, 01 (Off/On)	
Drawbar Level	08	0C	00	08	0C	01	00, 01 (0, -3dB)		
Lower & Upper Organ section	Organ Type	20	00	00	20	00	01	00 - 05 00: B-Type 1 01: B-Type 2 02: Mellow 03: Vx 04: Farf 05: Pipe	DRAWB
	Key Click Attack	20	01	00	20	01	01	00 - 0F (0 - 15)	
	Key Click Release	20	02	00	20	02	01	00 - 0F (0 - 15)	
	Fold Back Lo	20	03	00	20	03	01	00 - 0C (C1 - C2)	
	Fold Back Hi	20	04	00	20	04	01	2B - 30 (G4 - C5)	
	Key Click LPF	20	05	00	20	05	01	00 - 7F (0 - 127)	
	Custom TW B-Type 1	20	06	00	20	06	01	00 - 04 (1 - 5)	
	Custom TW B-Type 2	20	07	00	20	07	01	00 - 04 (1 - 5)	
	Custom TW Mellow	20	08	00	20	08	01	00 - 04 (1 - 5)	
	Octave Shift Upper	20	09	00	20	09	01	3E - 40 - 42 (-2 - 0 - +2)	
	Key Range Lo Upper	20	0A	00	20	0A	01	00 - 7F (MIDI note number)	
	Key Range Hi Upper	20	0B	00	20	0B	01	00 - 7F (MIDI note number)	
	Octave Shift Lower	20	0C	00	20	0C	01	3E - 40 - 42 (-2 - 0 - +2)	
	Key Range Lo Lower	20	0D	00	20	0D	01	24 - 60 (MIDI note number)	
	Key Range Hi Lower	20	0E	00	20	0E	01	24 - 60 (MIDI note number)	
	Switch Upper	20	0F	00	20	0E	01	00, 01 (Off/On)	
	Switch Lower	20	10	00	20	10	01	00, 01 (Off/On)	
	Volume	20	11	00	20	11	01	00 - 7F (0 - 127)	
Upper Registration	16'	--	--	01	01	00	01	00 - 08 (0 - 8)	UPPER
	5 1/3'	--	--	01	01	01	01	00 - 08 (0 - 8)	
	8'	--	--	01	01	02	01	00 - 08 (0 - 8)	
	4'	--	--	01	01	03	01	00 - 08 (0 - 8)	
	2 2/3'	--	--	01	01	04	01	00 - 08 (0 - 8)	
	2'	--	--	01	01	05	01	00 - 08 (0 - 8)	
	1 3/5'	--	--	01	01	06	01	00 - 08 (0 - 8)	
	1 1/3'	--	--	01	01	07	01	00 - 08 (0 - 8)	
1'	--	--	01	01	08	01	00 - 08 (0 - 8)		
Lower Registration	16	--	--	01	02	00	01	00 - 08 (0 - 8)	LOWER
	5 1/3'	--	--	01	02	01	01	00 - 08 (0 - 8)	
	8'	--	--	01	02	02	01	00 - 08 (0 - 8)	
	4'	--	--	01	02	03	01	00 - 08 (0 - 8)	
	2 2/3'	--	--	01	02	04	01	00 - 08 (0 - 8)	
	2'	--	--	01	02	05	01	00 - 08 (0 - 8)	
	1 3/5'	--	--	01	02	06	01	00 - 08 (0 - 8)	
	1 1/3'	--	--	01	02	07	01	00 - 08 (0 - 8)	
1'	--	--	01	02	08	01	00 - 08 (0 - 8)		

146 MIDI INFORMATION - continued

Category	Parameter	NRPN		SysEx Address			SysEx Length	Data	Preset Load
		LSB (62)	MSB (63)	MSB to LSB					
Pedal	Tone Wheel Set	22	00	00	22	00	01	00 - 06 00: Normal 01: Muted 02: Synth 1 03: Synth 2 04: Finger 05: Pick 06: Slap	DRAWB
	Attack	22	01	00	22	01	01	00 - 04 00: Slow Attack 01: No Click 02: Soft Click 03: Normal Click 04: Max Click	
	Sustain On	22	03	00	22	03	01	00, 01 (Off/On)	
	Sustain Length	22	04	00	22	04	01	00 - 04 (1 - 5)	
	Decay Length	22	05	00	22	05	01	00 - 05 (1 - 5, Cont)	
	Velocity	22	06	00	22	06	01	00 - 04 (Off, Normal - Easy)	
	Key Mode	22	07	00	22	07	01	00 - 02 (Lowest, Poly, Last)	
	Octave Shift	22	08	00	22	08	01	3E - 40 - 42 (-2 - 0 - +2)	
	Key Range Lo	22	09	00	22	09	01	24 - 60 (MIDI note number)	
	Key Range Hi	22	0A	00	22	0A	01	24 - 60 (MIDI note number)	
Pedal Registration	16'	--	--	01	03	00	01	00 - 08 (0 - 8)	PEDAL
	8'	--	--	01	03	01	01	00 - 08 (0 - 8)	
Organ Effect	Leslie Bypass	09	00	00	09	00	01	00, 01 (Enable / Bypass)	ANI
	Leslie Fast	09	01	00	09	01	01	00, 01 (Slow / Fast)	
	Leslie Stop	09	07	00	09	07	01	00, 01 (Turn / Stop)	
	Leslie Cabinet Number	09	08	00	09	08	01	00 - 07 (1 - 8)	
	Vibrato On Swell	09	02	00	09	02	01	00, 01 (Off/On)	
	Vibrato On Great	09	03	00	09	03	01	00, 01 (Off/On)	
	Vibrato Mode	09	04	00	09	04	01	00 - 05 (V1 - C3)	
	Vibrato Rate	09	05	00	09	05	01	00 - 04 (6.1 - 7.25Hz)	
	Vibrato V1 Depth	09	0D	00	09	0D	01	00 - 0F (1 - 16)	
	Vibrato V2 Depth	09	0E	00	09	0E	01	00 - 0F (1 - 16)	
	Vibrato V3 Depth	09	0F	00	09	0F	01	00 - 0F (1 - 16)	
	Vibrato C1 Depth	09	10	00	09	10	01	00 - 0F (1 - 16)	
	Vibrato C2 Depth	09	11	00	09	11	01	00 - 0F (1 - 16)	
	Vibrato C3 Depth	09	12	00	09	12	01	00 - 0F (1 - 16)	
	Vibrato Tremolo	09	13	00	09	13	01	00 - 0F (0 - 15)	
	Vibrato Cho. Emphasis	09	14	00	09	14	01	00 - 09 (0 - 9)	
	Vibrato On Pedal	09	15	00	09	15	01	00, 01 (Off/On)	
	Vibrato Cho. Mix	09	16	00	09	16	01	00 - 40 - 7F (D64 - EVEN - 63V)	

Category	Parameter	NRPN		SysEx Address			SysEx Length	Data	Preset Load
		LSB (62)	MSB (63)	MSB	to	LSB			
Effects	Overdrive On	3p	00	00	3p	00	01	00, 01 (Off/On)	EFFECT p=0: DRAWB p=1: EXV
	Overdrive Type	3p	01	00	3p	01	01	00 - 03 00: Tube 01: Stomp Box 02: Clip 03: E. Pf. Amp	
	Overdrive Drive Level	3p	02	00	3p	02	01	00 - 7F	
	Overdrive Controlled Exp.	3p	03	00	3p	03	01	00-03 00: EX-OD 01: OD-EX 02: OD Only 03: Input	
	Multi Effect On	3p	04	00	3p	04	01	00, 01 (Off/On)	
	Multi Effect Type	3p	05	00	3p	05	01	00-07 00: Tremolo 01: Auto Pan 02: Wah-Wah 03: Ring Mod. 04: Phaser 05: Flanger 06: Chorus 07: Delay	
	Multi Effect Parameter 0	3p	06	00	3p	06	01	00-03	
	Multi Effect Parameter 1	3p	07	00	3p	07	01	00-03	
	Multi Effect Parameter 2	3p	08	00	3p	08	01	00-7F	
	Multi Effect Parameter 3	3p	09	00	3p	09	01	00-7F	
	Multi Effect Parameter 4	3p	0A	00	3p	0A	01	00-7F	
	Multi Effect Parameter 5	3p	0B	00	3p	0B	01	00-7F	
	Multi Effect Parameter 6	3p	0C	00	3p	0C	01	00-7F	
	Multi Effect Parameter 7	3p	0D	00	3p	0D	01	00-7F	
	EQ Bass Gain	3p	0E	00	3p	0E	01	00 - 09 - 12 (-9 - 0 - +9)	
	EQ Bass Frequency	3p	0F	00	3p	0F	01	00 - 0A (20 - 200Hz)	
	EQ Mid Gain	3p	10	00	3p	10	01	00 - 09 - 12 (-9 - 0 - +9)	
	EQ Mid Frequency	3p	11	00	3p	11	01	00 - 0A (250 - 3.1kHz)	
	EQ Treble Gain	3p	12	00	3p	12	01	00 - 09 - 12 (-9 - 0 - +9)	
	EQ Treble Frequency	3p	13	00	3p	13	01	00 - 03 (4.0 - 8.0 kHz)	
	EQ Tone Control	3p	14	00	3p	14	01	00 - 09 - 12 (-9 - 0 - +9)	
	OD Output Level	3p	15	00	3p	15	01	00 - 7F (0 - 127)	
	Reverb On	0A	00	00	0A	00	01	00, 01 (Off/On)	REV
	Reverb Type	0A	01	00	0A	01	01	00 - 0A 00: Room 1 01: Room 2 02: Live House 03: Hall 1 04: Hall 2 05: Church 06: Plate 07: Spring 08: Delay 09: Panning Delay 0A: Reverb + Delay	
	Reverb Level	0A	02	00	0A	02	01	00 - 7F (0 - 127)	
	Reverb Time	0A	03	00	0A	03	01	00 - 7F (0 - 127)	
	Reverb Delay Feedback	0A	04	00	0A	04	01	00 - 1F (0 - 96%)	
	Reverb Delay Time	0A	05	00	0A	05	01	00 - 44 (4.7 - 2000ms)	

Example: "p" means Section number. Organ=0, Extra Voice=1
 Set Multi-Effect EXV at Phaser via NRPNBx 63 05 62 31 06 04 26 00 (x = Upper channel)
 Set Multi-Effect EXV at Phaser via SysExF0 55 dd 10 23 13 00 31 05 04 F7 (dd = Device ID)

Leslie Parameters

Category	Parameter	NRPN (SK)		NRPN (21)		SysEx Address			SysEx Length	Data
		LSB (62)	MSB (63)	LSB (62)	MSB (63)	MSB to LSB				
Cabinet	Name	--	--	--	--	03	00	00	0A	(10 Characters)
	Slow Speed Horn	06	00	7F	00	00	06	00	01	
	Slow Speed Bass	06	01	7F	01	00	06	01	01	
	Fast Speed Horn	06	02	7F	02	00	06	02	01	
	Fast Speed Bass	06	03	7F	03	00	06	03	01	
	Rise Time Horn	06	04	7F	04	00	06	04	01	
	Rise Time Bass	06	05	7F	05	00	06	05	01	
	Fall Time Horn	06	06	7F	06	00	06	06	01	
	Fall Time Bass	06	07	7F	07	00	06	07	01	
	Brake Time Horn	06	08	7F	08	00	06	08	01	
	Brake Time Bass	06	09	7F	09	00	06	09	01	
	Level Horn	06	0A	--	--	00	06	0A	01	
	Level Bass	06	0B	--	--	00	06	0B	01	
	Mic. Angle	06	0C	7F	0A	00	06	0C	01	
	Mic. Distance	06	0D	7F	0B	00	06	0D	01	
	Horn Character	06	0E	7F	0D	00	06	0E	01	
	Amplifier	06	0F	--	--	00	06	0F	01	
Speaker	06	10	--	--	00	06	10	01		

NRPN SK/21 is switched automatically by Leslie speaker is disconnected/connected.

System Parameters

Category	Parameter	Data Range	Default Value
MIDI	MIDI IN	Lower, Pedal, Low+Ped, Sequence, Upper, Upp+Ped	Pedal
	Local Control	Off/On	On
	TRx. NRPN	Off/On	On
	Tx. Leslie Param.	SK/21	SK
	Rx. Dump	Off/On	On
	TRx. Prog. Change	Off/On	On
	TRx. Drawbar Regi.	Off/On	On
	Tx. Ext. Zone	Off/On	Off
	TRx. Channel Upper	1 - 16, Off	1
	TRx. Channel Lower	1 - 16, Off	2
TRx. Channel Pedal	1 - 16, Off	3	
Device ID	1 - 32	1	
Music Player	Chain	All, One, Shuffle	All
Keyboard	Velocity Offset	-32 - +32	0
	Sounding Point	Deep / Auto	Deep
Transpose	Act Organ	Every / Next	Next
	Act Extra Voice	Every / Next	Next
Section	Part On Mode	Additive / Alternate	Additive
Audio	Output	Stereo / Mono	Stereo
Power	Auto Off	Disable / 30min	30min
Ext. Leslie	Channel(s)	1, 3	3

Tone Wheel Parameters

Category	Parameter	Data Range
Tone Wheel	Name	(10 characters)
	Level	-20 - +2 [dB]
	HPF Cut Off Freq.	0 - 127
	LPF Cut Off Freq.	0 - 127
	LPF Resonance	-100 - +100

Pipe Parameters

Category	Parameter	Data Range
Pipe	Volume	0 - 127
	Detune	-50 - +50
	Chiff	Off, Soft, Mid, Loud
	Cut Off Freq.	-64 - +0
	Pan - Direction	L64 - C - R63
	Pan - Imaging	Fixed, L-R, R-L, Pyramid, Inverted Pyramid

◆ BType1, BType2

Real B-3

B-3/C-3 in good condition. Contains moderate motor hum and leakage noise.

80's Clean

80's "clean-sounding" B-3/C-3. Motor hum or leakage noise is removed, "vibration" caused by the wow/flutter of the motor remained.

Noisy

Replicates the entire sound output from the B-3/C-3, including the motor hum and leakage noise.

Noisy 60

Leakage noise very prominent.

◆ Mellow

Full Flats

Pure sine waves, and all Tone Wheels oscillate at the same volume.

Husky

Slight mid-range boost and reduced volume.

Flute Lead

Similar to "Husky", but with reduced bass and treble.

Cheap Tr.s

Reduced bass-range - sound is similar to AM radio.

MIDI IMPLEMENTATION CHART

Stage Keyboard
Model: SKX

MIDI Implementation Chart

Date: 2-Jun-2017
Version: 1.0

Function		Transmitted	Recognized	Remarks
Basic Channel	Default Changed	*1 1 - 16	*1 1 - 16	*1: Upper = 1, Lower = 2, Pedal = 3
Mode	Default Messages Altered	3 X *****	3 X X	
Note Number	: True Voice	12 - 120 *2 *****	36 - 96 *3 36 - 96	*2: with oct. shift *3: Organ section
Velocity	Note ON Note OFF	O X	O X	
After Touch	Key's Ch's	X X	X X	
Pitch Bend		X	X	
Control Change	0, 32	O	O	Bank Select MSB, LSB
	1	X	X	Modulation
	6, 38	O	O	Data Entry MSB, LSB
	7	O	X	Volume
	10	O	X	Pan
	11	O	O	Expression
	12 - 20, 80	O	O	Drawbar Reg. Upper
	21 - 29, 81	O	O	Drawbar Reg. Lower
	33, 35, 82	O	O	Drawbar Reg. Pedal
	48	O	O	Spring Shock
	49	O	O	Glide
	64	O	O	Damper
	84	O	O	ProChord Active
	85, 86	O	O	Drawbar Priority
	92	X	O	Leslie Fast
98, 99	O	O	NRPN MSB, LSB	
Program Change	: True #	O 0 - 127	O 0 - 99, 127	
System Exclusive		O	O	
System Common	: Song Position : Song Select : Tune	X X X	X X X	
System Real Time	: Clock : Commands	X X	X X	
Aux Messages	: All Sounds Off : Reset All Controllers : Local On/Off : All Notes Off : Active Sense : Reset	X O X O O X	O O X O O X	(120) (121)

Mode 1: OMNI ON, POLY Mode 2: OMNI ON, MONO
Mode 3: OMNI OFF, POLY Mode 4: OMNI OFF, MONO

O: Yes
X: No

	External Zone (Tx. only)	Upper Part	Lower Part	Pedal Part
Note	O	O	O	O
Pitch Bend	X	X	X	X
Modulation	X	X	X	X
Volume, Pan (7, 10)	O	X	X	X
Expression (11)	O	O *1	X	X
Hold 1 (64)	O	O	O	O
Drawbar Reg.	X	CC#80, 12 - 20 (Upper) 21 - 29 (Lower) 33, 35 (Pedal)	CC#81	CC#82
Spring Shock (48)	X	O	X	X
Glide (49)	X	O	X	X
ProChord Active (84)	X	O	X	X
Drawbar Priority (85, 86)	X	O	X	X
Leslie Fast (92)	X	O *2	X	X
RPN (100, 101)	X	X	X	X
NRPN (98, 99)	X	O	X	X
All Notes Off (123)	O	O	O	O
All Sounds Off (120)	X	O *2	O *2	O *2
Reset All Ctrl. (121)	O	O	O	O
After Touch	X	X	X	X
Bank Select (0, 32)	Change the voice for each zone.	Patch	X	X
Program Change			X	X

*1: Affects all parts (audio controlled)

*2: Affects Rx. only.

Sound Generator**Organ Section**

- 2 - VASE III as Digital Tone-Wheels, Transistor Organ and Pipe Organ
- 61 polyphony (for Manual, except Pipe Organ)
- 8 polyphony (for Pedal, except Pipe Organ)
- 63 polyphony (maximum, on Pipe Organ)

Extra Voice Section

- VASE III, 63 polyphony (maximum)

Keyboards

- 2 x C1 to C6 61-key

Organ Section**Drawbars**

- Upper: 9 Pitches
- Lower: 9 Pitches
- Pedal: 2 Pitches

Organ Types

- Manuals: 6 choices (B-Type1, B-Type2, Mellow, Vx, Farf, Pipe)
- Pedal: 7 choices (Normal, Muted, Synth1, Synth2, Finger, Pick, Slap)

Touch Response Percussion

- Buttons: On, Volume Soft, Fast Decay, Third Harmonic

Extra Voice Section**Sections**

- 2 Sections for Manuals

Instruments

- 6 Groups (A. Piano, E. Piano, Keyboard, Wind, Other, Library)
- Upgradable via Library

Control

- Upper On, Lower On, Group

Effects**Vibrato and Chorus**

- Digital Scanner
- Buttons: Upper On, Lower On

Overdrive

- Digital, 4 programs
- Control: On, Amount

Multi Effects

- 8 programs for Organ/Extra Voice individually
- Control: On, Amount

Equalizer

- for Organ: Bass, Mid (sweep), Treble, Tone
- for Extra Voice: Bass, Mid (sweep), Treble

Internal Leslie

- Advanced Digital, 2 Rotors
- Buttons: Bypass, Stop, Fast

Reverb

- Digital, 11 programs
- Control: On, Depth

Master Equalizer

- Bass, Mid, Treble

Keymap**Buttons**

- Manual Bass, Lower to Pedal, Octave Up, Octave Down, Lower, Transpose

Patches**Capacity**

- 100 User Patches, 100 Preset Patches, Manual

Favorites

- 10 Banks, 10 Numbers

Patch Load Options

- Drawbar Registration, Drawbar Parameters, Extra Voice, Internal Zone, External Zone, Organ Effects, Animation, Exv Effects, Reverb

Controllers**Volumes**

- Master Volume, Organ Volume, Extra Voice Volume, Extra Voice Balance

Switch

- Power On/Off

Music Player**File Format**

- WAV (44.1kHz, 16bit, Stereo), MP3 (44.1kHz, 128kbps, Stereo)

Storage

- USB Flash Drive

Display

- 20 - Characters, 2 - Lines

MIDI**Templates**

- 4 Templates

External Zones

- 3 Zones, assignable any keyboards

Connections**MIDI**

- In, Out

Audio

- Line Out L, R, Headphones

Leslie

- 11 - pin, 1 and 3 channels available

Other

- Foot Switch, Damper Pedal, Exp. Pedal, DC IN (12V)

Accessory

- AC Adaptor AD3-1250-2P

Dimensions

- 944(W), 454(D), 170(H) mm

Weight

- 16.9kg

Index

A

Allocate 56
Assign 78
Auto Power Off 22

B

Back Up 22
Balance 75
Bank 24, 74

C

Cabinet Number 82
Chiff 88
Control 76
Coupler 53
Custom Tone-Wheels 85, 123, 149
Cut Off Frequency 86

D

Damper 78
Damper Pedal 26
Default 101
Detune 88
Display 79
Drawbar Priority 79
Drawbar Registration 42
Drawbars 28, 72. *also:* harmonic Drawbars
Drawbars Select 28, 47

E

Effects 90
Equalizer 98
Expand The Keyboard 18
Expression 75, 77
Expression Pedal 26
External Sequencer 108
External Zone 110
External Zone Channel 107
Extra Voice 30, 56, 75, 136

F

Factory Settings 22
Farf 45
Favorites 24, 74
Folder Structure 116
Foot Switch 26
Function Mode 66

G

Glide 78
Global Parameters 143

H

Harmonic Drawbars 40

I

Instrument 30, 75
Internal Zone 110

K

Keyboard Channels 107, 113
Key Click 72
Key Mode 73

L

Leakage Noise 86
Leslie 29, 51, 82
Leslie Channel 17, 84
Leslie Parameters 82, 148
Leslie Speaker 17
Library 56. *also:* Voice Library
Locking The Display 70
Lower to Pedal 33

M

MANUAL 27
Manual Bass 32, 53
Master Tune 100
Menu Mode 64
MIDI 103, 112
MIDI Keyboards 18
MIDI Sound Module 109
MIDI Template 112, 139
Mix 81
MONO 73, 102
Multi-Effects 29, 31, 52, 57
Music Player 125

O

Organ Type 38, 72
Organ Volume 47
Overdrive 29, 50, 90

P

Pan 88
Panic Function 111
Parameter 67
Part 32
Patch 23, 58, 74

Patch file 123
Patch Load 58, 74
Pedalboard 18
Percussion 28, 48, 80
Pipe 38, 46, 88
Play Mode 63
POLY 73, 110
Pop Up 79
Power 22
Preset 23
PRIO. *see:* Drawbar Priority
Pro-Chord 56, 77

R

Re-Load 111
Resonance 86
Reverb 31, 52, 57, 99

S

Setup 118, 121, 123
Setup File 116
Short Cut 69
Sounding Point 79
Spring Reverb 76
STEREO 102
System 102
System Exclusive Message 142

T

Time Out 79
Tip and Ring 76
Transpose 55
Tune 100

U

USB Flash Drive 116
User 23

V

Velocity Offset 79
Vibrato & Chorus 29, 49, 81
Voice Group 30, 75
Voice Library 129
Vx 38, 44

Z

Zones 110

Hammond maintains a policy of continuously improving and upgrading its instruments and therefore reserves the right to change specifications without notice. Although every attempt has been made to insure the accuracy of the descriptive contents of this Manual, total accuracy cannot be guaranteed.

Should the owner require further assistance, inquiries should first be made to your Authorized Hammond Dealer.

If you still need further assistance, contact Hammond at the following addresses:

In the United States Contact:
HAMMOND SUZUKI USA, Inc.

743 Annoreno Drive, Addison, Illinois
60101
UNITED STATES
Tel: (630) 543-0277
Fax: (630) 543-0279

Web site: www.hammondorganco.com
E-mail: info@hammondorganco.com

Product Registration

<http://hammondorganco.com/support/online-product-registration/>



In European countries contact:
HAMMOND SUZUKI EUROPE B. V.

IR. D. S. Tuynmanweg 4a 4131 PN Vianen
THE NETHERLANDS
Tel: (+31) 347-370 594
Web site: www.hammond.eu
E-mail: info@hammond.eu

Product Registration

<http://www.hammond.eu/support/online-product-registration/>



Please contact Suzuki Corpora-
tion for other countries.

HAMMOND SUZUKI Ltd.

2-25-11, Ryoke, Naka-ku, Hamamatsu,
Shizuoka Pref. 430-0852

JAPAN

Tel: (+81) 53-460-3781

Fax: (+81) 53-460-3783

E-mail: suzukicorp@suzuki-music.co.jp

Technical materials are available and can be obtained by mailing a request to the appropriate address listed above marked ATTENTION: SERVICE DEPARTMENT.

Manufacturer:

SUZUKI MUSICAL INSTRUMENT MFG. Co., Ltd.

2-25-12, Ryoke, Naka-ku, Hamamatsu, Shizuoka Pref. 430-0852
JAPAN

