

# REDNET MP8R

MIC PRE

## User Guide

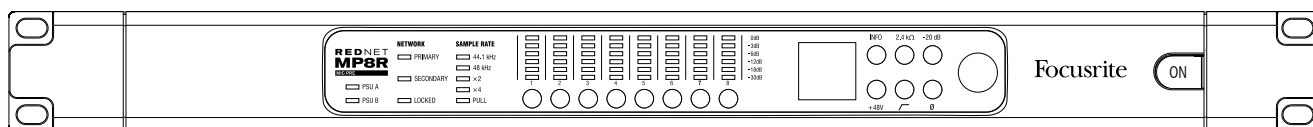

Focusrite®  
[www.focusrite.com](http://www.focusrite.com)

# CONTENTS

About this User Guide .....	3
Box Contents .....	3
<b>INTRODUCTION .....</b>	<b>4</b>
Gain Compensated Split Outputs .....	5
Headroom Allowance .....	5
<b>INSTALLATION GUIDE .....</b>	<b>6</b>
RedNet MP8R Connections and Features .....	6
Front Panel .....	6
Rear Panel .....	8
Power Connection .....	9
IEC Power Cord Retaining Clips .....	9
Physical Characteristics .....	10
Power Requirements .....	10
<b>REDNET MP8R OPERATION .....</b>	<b>11</b>
First Use and Firmware Updates .....	11
Digital Clocking .....	11
Pull Up and Pull Down Operation .....	11
Front Panel Control Lockout .....	11
Gain Compensated Outputs .....	11
<b>OTHER REDNET SYSTEM COMPONENTS .....</b>	<b>12</b>
<b>USING REDNET CONTROL .....</b>	<b>12</b>
ID (Identification) .....	13
Tools Menu .....	13
<b>APPENDIX .....</b>	<b>14</b>
Connector Pinouts .....	14
Ethernet Connector .....	14
XLR Connectors .....	14
<b>PERFORMANCE AND SPECIFICATIONS .....</b>	<b>15</b>
Focusrite RedNet Warranty and Service .....	17
Registering Your Product .....	17
Customer Support and Unit Servicing .....	17
Troubleshooting .....	17

## About this User Guide

This User Guide applies only to the RedNet MP8R Mic Preamplifier. It provides information about installing a RedNet MP8R and how to connect it into your system.

A RedNet System User Guide is also available from the RedNet product pages of the Focusrite website. The Guide provides a detailed explanation of the RedNet system concept, that will help you achieve a thorough understanding of its capabilities. We recommend that all users, including those already experienced in digital audio networking, take the time to read through the System User Guide so that they are fully aware of all the possibilities that RedNet and its software have to offer.

Should either User Guide not provide the information you need, be sure to consult:

[www.focusrite.com/rednet](http://www.focusrite.com/rednet), which contains a comprehensive collection of common technical support queries.

## Box Contents

- RedNet MP8R unit
- 2 x IEC AC mains cables
- 2 x IEC mains cable retaining clips (*See instructions on page 9*)
- Safety information cut sheet
- RedNet Getting Started Guide
- Product registration card, provides links to:
  - RedNet Control
  - RedNet PCIe drivers (included with RedNet Control download)
  - Audinate Dante Controller (installed with RedNet Control)
  - Dante Virtual Soundcard (DVS) Token and download instructions

# INTRODUCTION

Thank you for purchasing the Focusrite RedNet MP8R.



RedNet MP8R is an 8-channel remote-controlled microphone preamplifier and A/D for the Dante audio-over-IP network. Specifically tailored for the road, live-sound and broadcast environments, each unit features network and power redundancy, rugged construction with latching connectors, remote control and remote monitoring. In addition, a gain-compensated split output is available on every channel (*see following page for further detail*).

Eight remote-controlled Focusrite mic preamps and precision A/D conversion at up to 192kHz/24-bit with minimum latency.

Dual Ethernet connectors (primary and secondary) on the rear-panel allow maximum network reliability with seamless switchover to a standby network in the unlikely event of a network failure. These ports may also be used to daisy-chain additional units when operating in Switched mode.

Redundant power supplies (PSU A and B) with separate input sockets on the rear panel allow one supply to be connected to an uninterruptible source. Each PSU's status can be monitored remotely over the network or from the front panel.

Audio input uses locking XLR3F connectors on the rear panel.

Rotary gain control with OLED level display for indication of gain settings and system information. A Select button plus 6-segment level meter is provided for each channel. Individual buttons for the selection of input impedance, 20dB Pad, 48V phantom power, high-pass filter and polarity inversion are included on the front panel.

Channels can be remotely controlled via the RedNet Control software package, Pro Tools and MIDI, or OCA (Open Control Architecture) with future firmware updates.

The RedNet MP8R front panel contains a set of LEDs to confirm network status, sample rate and clock sources as well as each mic amp's input and gain settings.

## Gain Compensated Split Outputs

The RedNet MP8R is able to provide two outputs from each mic channel: one direct and a second automatically gain-compensated to deliver a constant level. This arrangement allows one engineer (FOH, say) to control the analogue mic gain without affecting the signal level being received by a second engineer on the network.

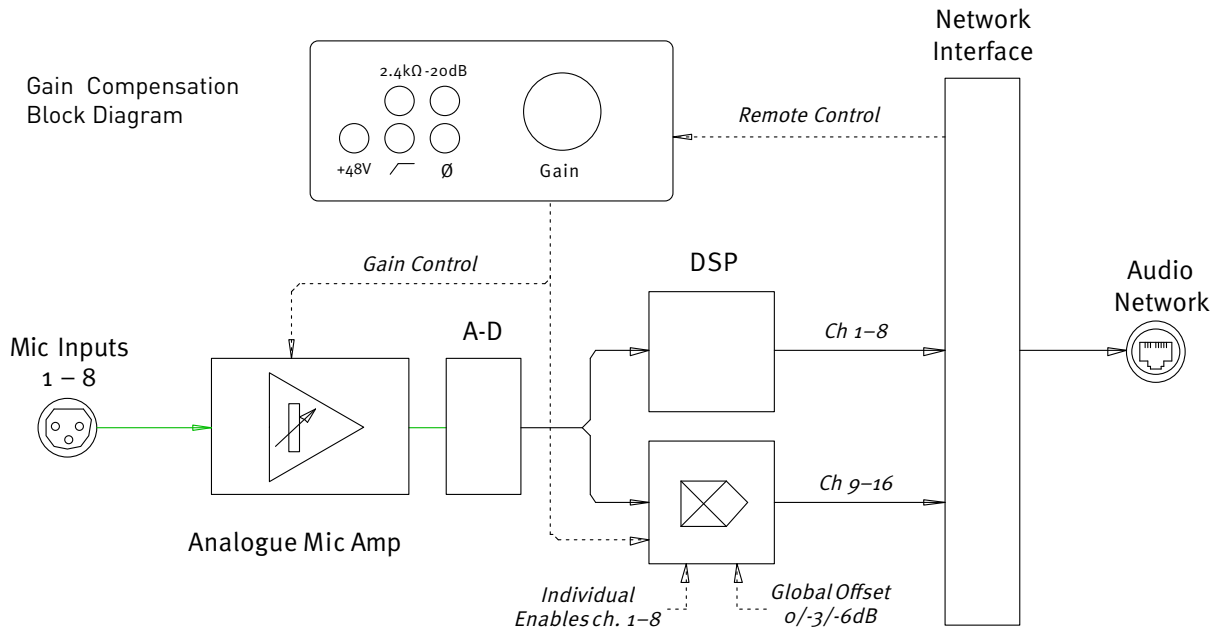

The output of the mic amp module feeds the A-D converter. Once in the digital domain, the signal is split into two streams. The first stream passes through unaffected to the corresponding Dante transmitter. The second stream passes through a DSP amplifier which automatically compensates for any changes made to the analogue audio level – either by the front panel controls or over the network. The unit will therefore appear as a 16-channel device on the Dante network, with channels 1-8 being the direct outputs from the preamps and channels 9-16 the compensated outputs.

Gain compensation can be enabled individually for each mic channel.

### Headroom Allowance

If during a performance an analogue mic level was reduced by 3dB, the DSP gain for the corresponding 'split' channel would be increased by 3dB to maintain its overall signal level<sup>†</sup>. Note however, that this action would push the DSP section 3dB closer to its clipping point. To minimise the likelihood of the DSP ever reaching its clipping point an offset can be applied to allow for some reserve headroom.

The default headroom offset setting will be -6dB, but the user can select 0dB or -3dB from the tools menu under RedNet Control. The setting is applied to all channels 9-16.

<sup>†</sup>The global range of the gain compensation available is currently limited to tracking  $\pm 12$ dB from the point at which it was enabled.

# INSTALLATION GUIDE

## RedNet MP8R Connections and Features

### Front Panel

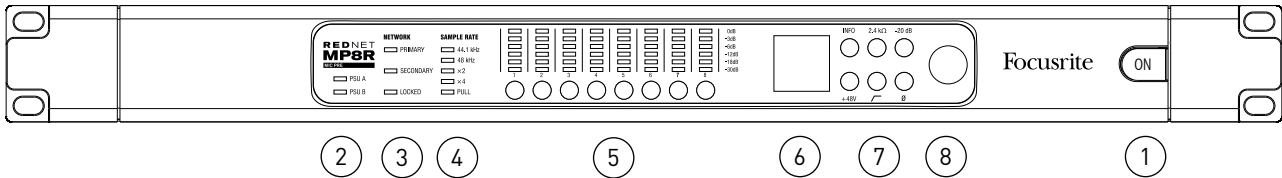

#### 1. AC Power Switch

#### 2. Power Indicators:

- **PSU A** – Illuminates when an AC input is applied and all DC outputs are present.
- **PSU B** – Illuminates when an AC input is applied and all DC outputs are present.

When both supplies are functioning and have AC inputs PSU A will be the default supply.

#### 3. RedNet Network Status Indicators:

- **PRIMARY** – Illuminates when the device is connected to an active Ethernet network. Also illuminates to indicate network activity when operating in switched mode.
- **SECONDARY** – Illuminates when the device is connected to an active Ethernet network. Not used when operating in Switched mode.
- **LOCKED** – Illuminates when a valid sync signal is received from the network, or when the RedNet MP8R unit is Network Master.

#### 4. RedNet Sample Rate Indicators

Five orange indicators: **44.1 kHz**, **48 kHz**, **x2** (multiple of 44.1 or 48), **x4** (multiple of 44.1 or 48) and sample rate **PULL UP/DOWN**. These Indicators illuminate individually or in combination to indicate the sample rate being used. For example: for a 96kHz Pull Up/Down setting, the 48kHz, x2 and Pull Up/Down indicators will illuminate.

#### 5. Channel Select Switches and Signal Level LEDs

A Select switch plus six signal-level LEDs for each of the eight channels. Pressing a switch selects which channel is to be controlled – the OLED display will then indicate the current gain setting of that channel. Signal level LEDs illuminate at: -30dB, -18dB, -12dB (green), -6dB, -3dB (orange) and 0dB/onset of clipping (red).

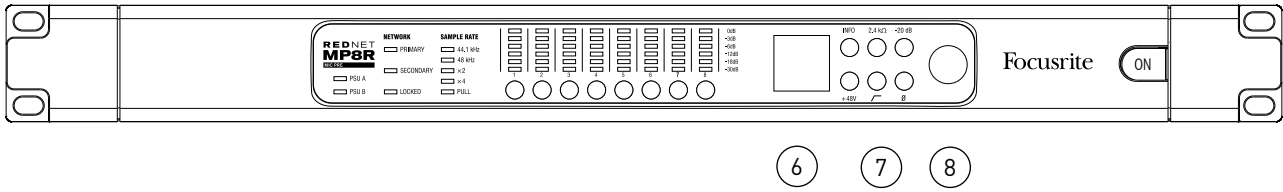

*The Select switches can also be used to activate front panel control lockout; see page 11.*

## Front Panel ... Continued

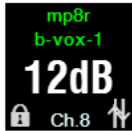

### 6. OLED Display



Indicates the currently selected channel's network name and its gain value and if either Control Lockout  or Gain Compensation  is active. Also changes to display local and network configuration settings when in INFO mode. See below.

### 7. Local Control Buttons:

- **INFO** – Press to show device and network information on the OLED display [button will flash orange when Info mode is engaged]. Pressing again cycles through following unit settings:

- Unit IP addresses (primary)
- Unit IP addresses (secondary)
- Unit MAC addresses (primary)
- Unit MAC addresses (secondary)
- Firmware Version for the unit
- Device name

<b>PRIMARY IP</b> 169. 254. 17. 55.	<b>SECONDARY MAC</b> 00:1D:C1 02:02:5D
<b>VERSION</b> 903/871 3.7.1.6 3.1.5	<b>UNIT NAME</b> MP8R Stage-Left

- **+48V** – Switches phantom power on for selected channel.
- **2.4 kΩ** – Selects low input impedance for selected channel.
-  – Switches on high-pass filter for selected channel.
- **-20 dB** – Switches input pad in for selected channel.
- **∅** – Inverts polarity of signal on selected channel.

### 8. Encoder

The detented encoder is used as the gain control for the selected mic channel.

*Note: When renaming a device, the name will appear on a single line on the OLED display. To separate the name over two lines like the OLED example above, add in a double-dash '--'. In the example above, this would be written as 'mp8r--b-vox-1'.*

## Rear Panel

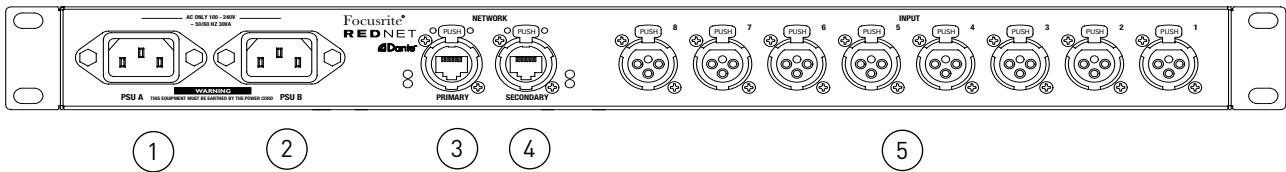

### 1. IEC Mains Inlet A

Standard IEC receptacle for connection of AC mains. RedNet MP8R features 'Universal' PSUs, enabling it to operate on any supply voltage of between 100 V and 240 V AC.

*Note that initial use requires fitment of the plug retaining clips – see page 9.*

### 2. IEC Mains Inlet B

Input connector for backup mains power source. Power supply B remains on standby but will seamlessly take over if PSU A develops a fault or loses its mains input supply.

*If an uninterruptible supply (UPS) is available, it is recommended that this is applied to input B.*

### 3. Primary Network Port

Latching etherCON connector for the Dante network. Use standard Cat 5e or Cat 6 network cable to connect to a local Ethernet switch to connect the RedNet MP8R to the RedNet network. Adjacent to each network socket are LEDs which illuminate to indicate a valid network connection plus network activity. *See page 14 for connector details.*

### 4. Secondary Network Port

Secondary Dante network connection where two independent Ethernet links are being used (Redundant mode) or an additional port on an integral network switch on the primary network (Switched mode).

### 5. Microphone inputs

Eight latching XLR3F connectors for mic/line input.

*See page 14 for connector pinouts.*



## Power Connection

### IEC Power Cord Retaining Clips

RedNet MP8R is supplied with two IEC power cord retaining clips. These prevent accidental disconnection of a power cord during use. When the unit is first installed, the retaining clips will need to be attached to the power input sockets on the rear panel.

Insert each clip by squeezing together the legs as shown in the first image below, aligning the pins with the through-holes on the IEC fixing posts one at a time, and then releasing.

Ensure that the orientation of each clip is as shown in the other images below or its effectiveness will be compromised.

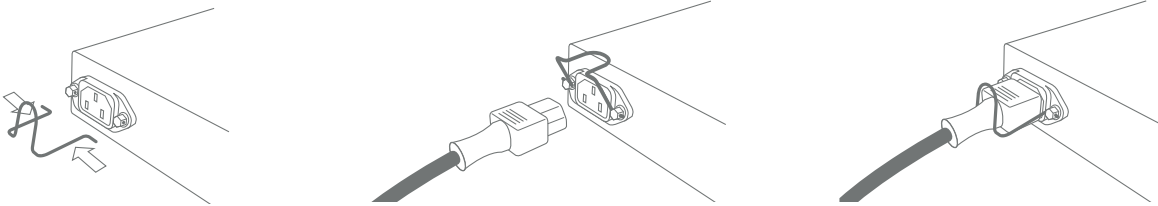

## Physical Characteristics

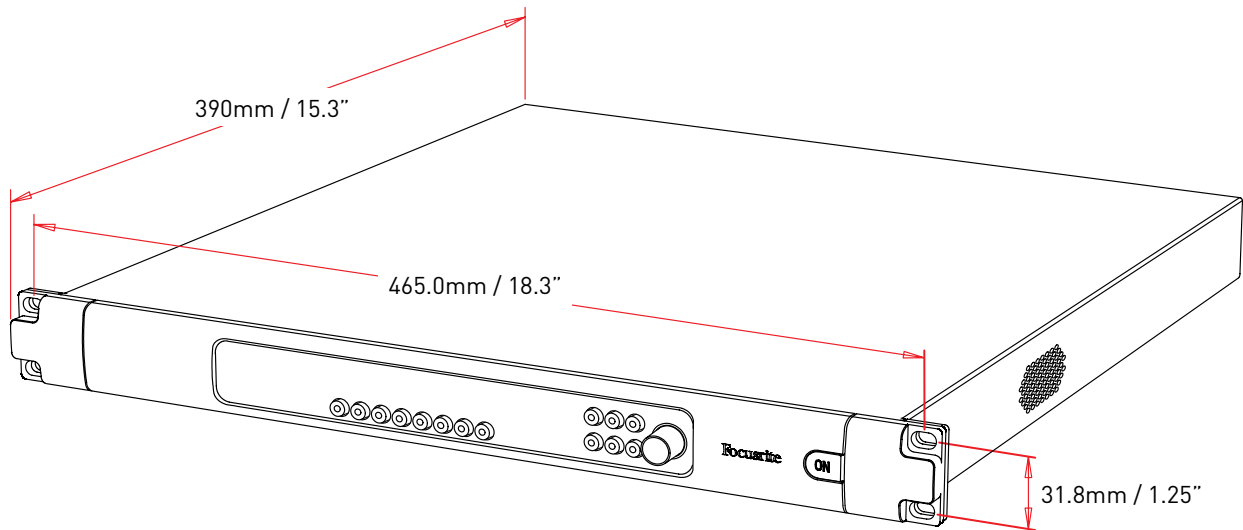

RedNet MP8R dimensions are illustrated in the diagram above.

RedNet MP8R requires 1U of vertical rack space and at least 440mm of rack depth, to allow for cables. RedNet MP8R weighs 5.75 kg and for installations in a fixed environment (eg., a studio), the front-panel mounting screws will provide adequate support. If the units are to be used in a mobile situation (eg., flight-cased for touring, etc.), it is recommended that side support rails or shelves should be used within the rack.

Cooling is by low-noise fan assistance from side to side. The fan used is low-speed and low-noise but can also be turned off via RedNet control. The ambient operating temperature of the device is 50 degrees Celcius.

Do not mount RedNet MP8R immediately above any other equipment which generates significant heat, for example, a power amplifier. Also, ensure that when mounted in a rack, the side vents are not obstructed.

## Power Requirements

RedNet MP8R is mains-powered. It incorporates 'Universal' power supplies, which can operate on any AC mains voltage from 100 V to 240 V. The AC connections are made via a standard 3-pin IEC connectors on the rear panel.

When PSU A & PSU B are both connected, PSU A becomes the default supply and therefore draws more current than B. If a backup mains supply is provided from an uninterruptible source, it is recommended that this is connected to input B.

Mating IEC cables are supplied with the unit; these should be terminated with mains plugs of the correct type for your country.

The AC power consumption of the RedNet MP8R is 30VA.

Please note that there are no fuses in RedNet MP8R, or other user-replaceable components of any type. Please refer all servicing issues to the Customer Support Team (see "Customer Support and Unit Servicing" on page 17).

# REDNET MP8R OPERATION

## First Use and Firmware Updates

Your RedNet MP8R may require a firmware update\* when it is first installed and switched on. Firmware updates are initiated and handled automatically by the RedNet Control application.

*\*It is important that the firmware update procedure is not interrupted – either by switching off power to the RedNet MP8R or the computer on which RedNet Control is running, or by disconnecting either from the network.*

From time to time Focusrite will release RedNet firmware updates within new versions of RedNet Control. We recommend keeping all RedNet units up to date with the latest firmware version supplied with each new version of RedNet Control.

## Digital Clocking

Each MP8R will automatically lock to a valid Network Master via its Dante connection. Alternatively, if a Network Master is not present, then the unit can be chosen as the Network Master by the user.

## Pull Up and Pull Down Operation

RedNet MP8R is able to operate at a specified pull up or pull down percentage as selected in the Dante Controller application.

## Front Panel Control Lockout

To prevent accidental adjustment of any control that could affect a channel's audio level, the MP8R front panel can be locked-out. When locked, the gain encoder and the channel function switches become inactive for all eight channels. Channel settings can still be viewed on the OLED display by pressing the channel Select buttons and the INFO button will still operate as normal.

- To activate lockout: Press channel Select buttons 1, 3, 5 & 7 simultaneously.
- To de-activate lockout: Press channel Select buttons 2, 4, 6 & 8 simultaneously.

The Lock icon  illuminates on the OLED display when lockout is active. Lockout can also be activated and de-activated from the Tools menu under RedNet Control.

## Gain Compensated Outputs

To turn on gain compensation in the corresponding 'split' output for any channel, press and hold the channel Select button until the Gain Compensation icon  illuminates on the OLED display. To turn off, press and hold Select again until the Lock icon is no longer visible.

Gain Compensation can also be activated and de-activated for each channel from the device graphic on RedNet Control.

## OTHER REDNET SYSTEM COMPONENTS



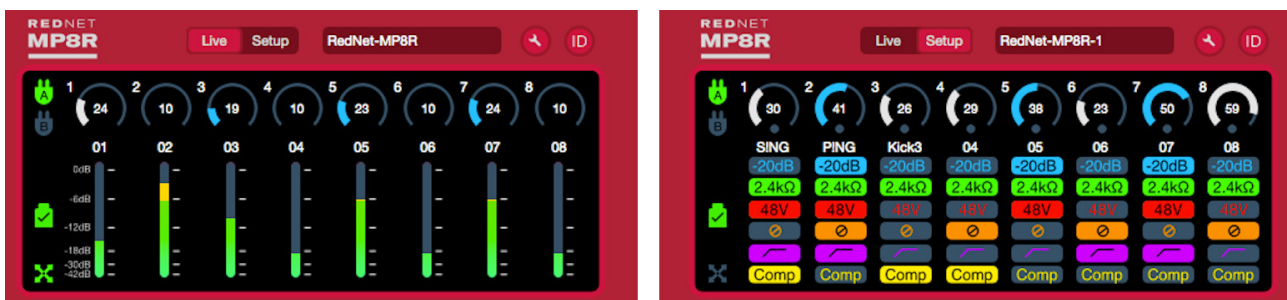

The RedNet hardware range includes various types of I/O interface and PCIe/ PCIeR digital audio interface cards which are installed in the system's host computer or in a chassis. All the I/O units can be considered as "Break-Out" (and/or "Break-In") boxes to/from the network, and all are built in mains-powered, 19" rackmount housings, unless otherwise stated. There are also three software items, RedNet Control (see below), Dante Controller and Dante Virtual Soundcard.

## USING REDNET CONTROL

RedNet Control will reflect the status of the RedNet units present in the system, presenting an image representing each hardware unit.



The illustration above shows the RedNet MP8R RedNet Control image. The signal level, gain and input function settings are indicated for each channel. Use the Live and Setup buttons at the top of the graphic to change view.

-  PSUs A & B – Each illuminates if PSU has power input and all DC outputs are present.
-  Networks – Each illuminates if a valid connection is present.
-  Locked – Unit is successfully locked to the network (changes to the red cross if not locked).
-  Network Master – Illuminated indicating that unit is the network master.

### Device View

- Pad** – Switches in the -20dB input pad for the selected channel
- 2.4kΩ** – Selects low input impedance for the selected channel
- +48V** – Switches the phantom power on for the selected channel
- ∅** – Reverses the phase of the selected channel
-  – Switches in the high-pass filter for the selected channel
- Gain Compensation** – Turns on gain compensation. While engaged, on-board DSP will counteract analogue gain changes for the second set of network outputs (Channels 9-16)

## ID (Identification)

Clicking on the ID icon  will identify the physical device being controlled by flashing its front panel LEDs.

## Tools Menu

Clicking on the Tools icon  will gain access to the following system settings:

**Preferred Master** – On/Off state.

**MIDI Channel Select** – Set the MIDI channel (1 – 16) to which the unit will respond:

- Off
- MIDI Channel 1
- MIDI Channel 2
- ↓
- MIDI Channel 16

Notes:

- The default is "Off"
- 16 channels are available, allowing a maximum of 16 independent RedNet MP8R control paths
- Two devices should not be set to the same MIDI channel
- MIDI channel selection is saved with the computer, not the device. Therefore, when controlling the same unit from a different computer, the MIDI channel allocation may no longer be the same

For more information, please download the MIDI Control User Guide from [www.focusrite.com](http://www.focusrite.com)

**Yamaha ID** – Set the Yamaha ID (Y000 – Y00F) to which the unit will respond:

- Off
- Y000
- Y001
- ↓
- Y00F

For more information, please refer to the Yamaha Control user guide, available at [www.focusrite.com](http://www.focusrite.com)

**Gain Compensation Headroom** – Offset value for network channels 9– 16. Only one can be selected at any time.

- 0dB
- -3dB
- -6dB

**Front Panel Lockout** – On or Off. Disables front panel audio controls.

**Fan** – On or Off. For use when unit is located in silent recording areas.

# APPENDIX

## Connector Pinouts

### Ethernet Connector

Connector type: RJ-45 receptacle  
Applies to: Ethernet (Dante)

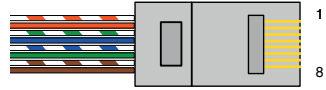

Pin	Cat 6 Core
1	White + Orange
2	Orange
3	White + Green
4	Blue
5	White + Blue
6	Green
7	White + Brown
8	Brown

### XLR Connectors

Connector type: XLR-3 receptacle  
Applies to: Audio Input

Pin	Signal
1	Screen
2	Hot (+ve)
3	Cold (-ve)

# PERFORMANCE AND SPECIFICATIONS

<b>Microphone Inputs</b>	
Gain Range	10dB to 65dB in 1dB steps
Type	Electronically Balanced, $Z_{in} = 2.4k\Omega/10k\Omega$ (Switchable); Inputs default to 2.4k $\Omega$ when unit is unpowered
Maximum Input Level	29dBu $\pm 0.5$ ; min gain with pad for 0dBFS, $R_s = 150\Omega$
Minimum Input Level	-46dBu $\pm 0.5$ ; max gain without pad for 0dBFS, $R_s = 150\Omega$
Frequency Response	20Hz – 40kHz $\pm 0.1$ dB
THD + N	-98dB (0.0012%) @ -1dBFS, $R_s = 150\Omega$
EIN	-129 dBu 'A'-Weighted (typical), $R_s = 150\Omega$
Signal-to-Noise Ratio	118 dB 'A'-Weighted (typical), $R_s = 150\Omega$
Phantom Power	+48V, independently switchable per channel
Pad	-20dB, independently switchable per channel
High-Pass Filter	-6dB @ 65Hz $\pm 3$ Hz, 12dB/Octave, independently switchable per channel

<b>Crosstalk</b>	
Input to Input	<-100dB 20Hz-20KHz; minimum input gain

<b>Digital Performance</b>	
Supported Sample Rates	44.1 / 48 / 88.2 / 96 / 176.4 / 192 kHz [-4% / -0.1% / +0.1% / +4.167%] at 24 bit
Clock Sources	Internal or from Dante Network Master

<b>Rear Panel Connectivity</b>	
<b>Inputs</b>	
Inputs	8 x female XLR-3
<b>PSU &amp; Network</b>	
PSU	2 x IEC male inputs with retaining clips
Network	2 x etherCON NE8FBH-S, also compatible with standard RJ45 connectors (Accommodates rugged etherCON NE8MC*. Does not intermate with Cat 6 cable connector NE8MC6-MO and NKE65* cable)

<b>Indicators</b>	
Primary PSU (A)	Green LED. Illuminates when an AC input is applied and all DC outputs are present.
Secondary PSU (B)	Green LED. Illuminates when an AC input is applied and all DC outputs are present.
Primary Network	Green LED. Indicates that a network connection is present on primary port when in redundant mode. When in Switched mode, a valid network connection at either Primary or Secondary network port will cause this LED to illuminate.
Secondary Network	Green LED. Indicates that a network connection is present on secondary port when in redundant mode. Not used in switched mode.
Network Locked	Green LED. When unit is network slave, shows valid network lock. When unit is network master, shows lock to internal clock.
Sample Rate	Orange LED for each: 44.1 kHz, 48 kHz, x2, x4
Pull Up/Down	Orange LED. Indicates unit is set to operate on a Dante pull up/down domain.
Channel Signal level	6 level indicator LEDs for each channel. 3 green LEDs, (-30dB, -18dB, -12dB); 2 orange LEDs (-6dB, -3dB); red LED (0dB/onset of clipping).
Channel Select Buttons	8
Channel Function Controls	Info, Phantom Power, Pad, Impedance, HPF, Phase, Gain Encoder.
Channel Display	Colour OLED. Displays Channel Name, Gain, Lock status (when on), Channel Number, Gain Compensation status (when on).

<b>Network Modes</b>	
Redundant	Allows unit to connect to two independent networks
Switched	Connects both ports to integrated network switch allowing daisy-chaining of device

<b>Dimensions</b>	
Height	44.5mm / 1.75" (1RU)
Width	482.6mm / 19"
Depth	394mm / 15.51"

<b>Weight</b>	
Weight	5.75kg

<b>Power</b>	
PSU	2 x Internal, 100-240V, 50/60Hz, consumption 30VA



## **Focusrite RedNet Warranty and Service**

All Focusrite products are built to the highest standards and should provide reliable performance for many years, subject to reasonable care, use, transportation and storage.

Very many of the products returned under warranty are found not to exhibit any fault at all. To avoid unnecessary inconvenience to you in terms of returning the product please contact Focusrite support.

In the event of a Manufacturing Defect becoming evident in a product within 12 months from the date of the original purchase Focusrite will ensure that the product is repaired or replaced free of charge.

A Manufacturing Defect is defined as a defect in the performance of the product as described and published by Focusrite. A Manufacturing Defect does not include damage caused by post-purchase transportation, storage or careless handling, nor damage caused by misuse.

Whilst this warranty is provided by Focusrite the warranty obligations are fulfilled by the distributor responsible for the country in which you purchased the product.

In the event that you need to contact the distributor regarding a warranty issue, or an out-of-warranty chargeable repair, please visit: [www.focusrite.com/distributors](http://www.focusrite.com/distributors)

The distributor will then advise you of the appropriate procedure for resolving the warranty issue. In every case it will be necessary to provide a copy of the original invoice or store receipt to the distributor. In the event that you are unable to provide proof of purchase directly then you should contact the reseller from whom you purchased the product and attempt to obtain proof of purchase from them.

Please do note that if you purchase a Focusrite product outside your country of residence or business you will not be entitled to ask your local Focusrite distributor to honour this limited warranty, although you may request an out-of-warranty chargeable repair.

This limited warranty is offered solely to products purchased from an Authorised Focusrite Reseller (defined as a reseller which has purchased the product directly from Focusrite Audio Engineering Limited in the UK, or one of its Authorised Distributors outside the UK). This Warranty is in addition to your statutory rights in the country of purchase.

## **Registering Your Product**

For access to Dante Virtual Soundcard, please register your product at: [www.focusrite.com/register](http://www.focusrite.com/register)

## **Customer Support and Unit Servicing**

You can contact our dedicated RedNet Customer Support team free of charge:

Email: [rednetsupport@focusrite.com](mailto:rednetsupport@focusrite.com)

Phone (UK): +44 (0)1494 462246

Phone (USA): +1 (310) 322-5500

## **Troubleshooting**

If you are experiencing problems with your RedNet MP8R, we recommend that in the first instance, you visit our Support Answerbase at: [www.focusrite.com/answerbase](http://www.focusrite.com/answerbase)