

AVANDA 212A

AVANDA 212A is a dual 12" three-way active DSP controlled line array speaker. Designed for medium to large-scale sound reinforcement applications and mid-to-high-end fixed installations, it provides a high quality and powerful sound, meeting the requirements of any sound reinforcement application, indoors or outdoors.

The AVANDA 212A achieves a narrow vertical coverage in the high frequency range through the innovative ARROWHEAD™ waveguide technology, providing a clearer sound performance. The 90° horn provides a precise horizontal coverage and ensure that the system delivers an even and smooth sound.

CNC machined birch plywood cabinet, coated with polyurea, is waterproof, wear and high temperature resistant.

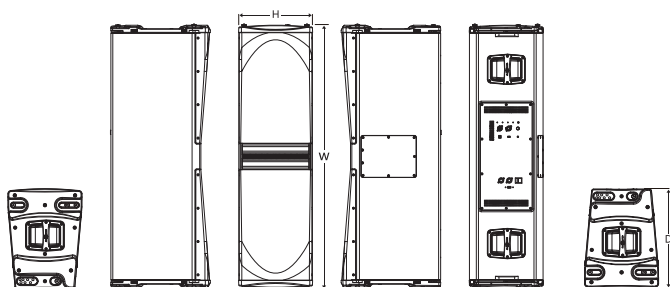

Dimension(W×H×D): 1220×344×464 mm

Key Features

- Perfect integration of Braincore™ technology achieves supreme performance of the speaker system.
- ARROWHEAD™ waveguide technology
- 3 presets
- High end DSP, with 96KHz signal sampling frequency, with FIR filter
- Class D amplifier
- Automatically enter sleep mode after 45 minutes without signal input
- Advanced temperature control system
- Customized driver
- Optimized, compact cabinet design
- Durable polyurea coating
- CNC machined birch plywood cabinet, coated with polyurea, is waterproof, wear and high temperature resistant.



Specification

Frequency Response(-6dB)	50Hz-20kHz
Maximum Calculated SPL/1M(Continuous/Peak)	136dB/142dB
LF	Customized 2x12" driver, 3"voice coil
MF	Customized 4x6" driver, 1.75"voice coil
HF	Customized Neodymium driver, 2x3"voice coil, 1.4"exit
Horizontal Coverage	90°
Vertical Coverage	Splay angle dependent
AMPLIFIER	
Amplifier Circuitry	Class D
Power(RMS standards)	2600W
Frequency Response (1W 8Ω 2ch)	20Hz-20kHz(±0.5dB)
Intermodulation Distortion	< 0.05%
Total Harmonic Distortion	< 0.05%
Protection	DC protection, short circuit protection, overheat protection, input overload protection, output overload protection, soft startup protection, overvoltage protection, undervoltage protection
Cooling System	Cooling with fans,air convection
DSP	
Processor	96kHz signal sampling frequency, FIR filtering
Presets	4 Units,8 Units,12 Units
Output/Input	
Signal Input	1× female XLR
Signal Output	1× male XLR
Power Input	Power connector
Power Output	Power connector
AC Power Operating Range	100V-130V~ or 220V-240V~(±10%,50/60Hz)
Power consumption (1/8 output power)	300W
Cabinet	
Angle Adjustment	0°, 1°, 2°, 4°, 6°, 8°, 10°
Cabinet Material	Russian birch plywood
Coating	Durable Polyurea Coating
Cabinet Color	Black is the default color. Contact Audiocenter for customization
Dimension(W×H×D)	1220×344×464mm
Net Weight	67.0Kg



Frequency Response Graphs

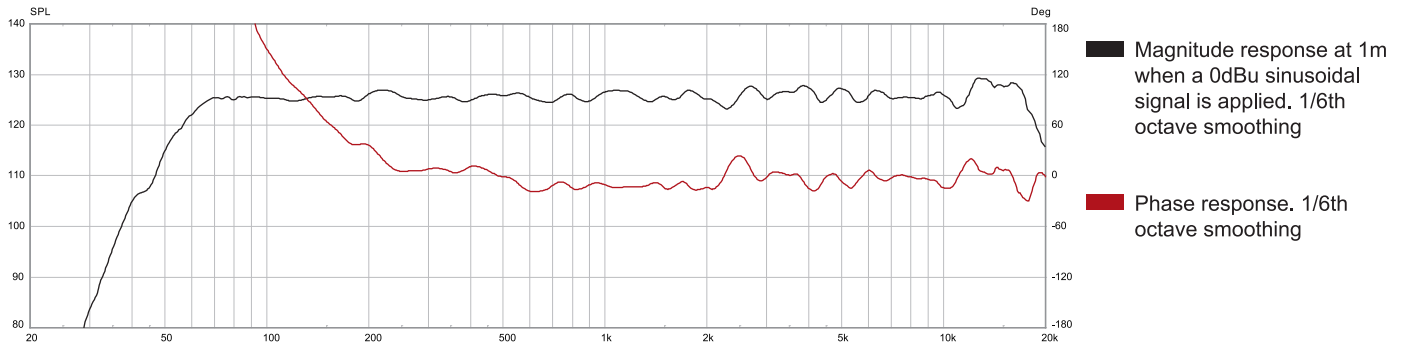

Normalized Isobar Plot

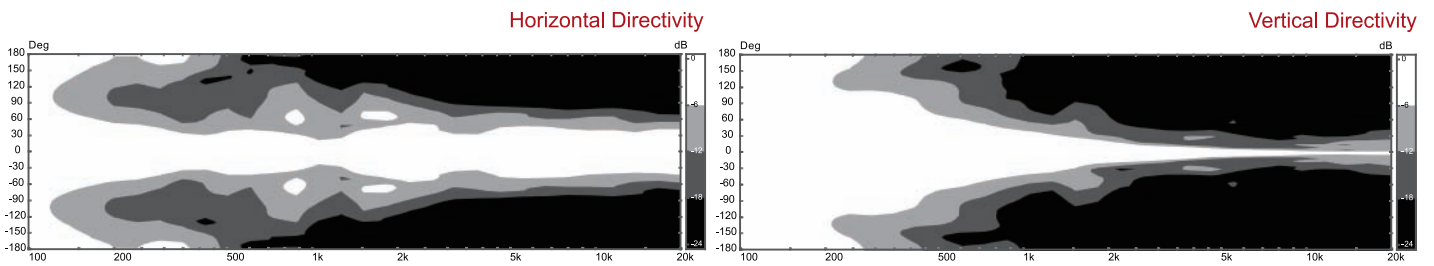

Internal Structure

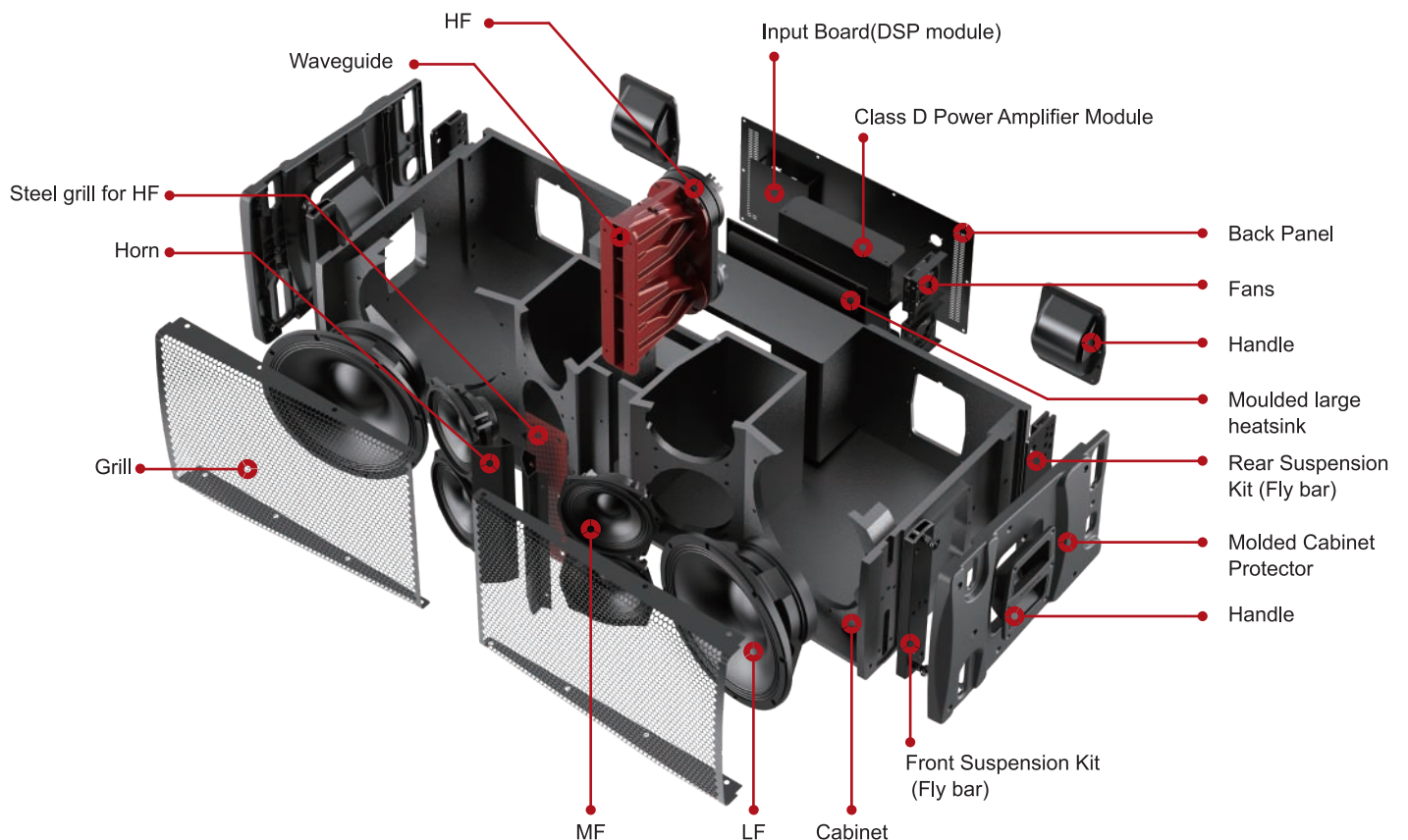

Accessories

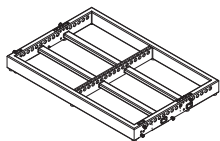

Frame for flying and ground stacking

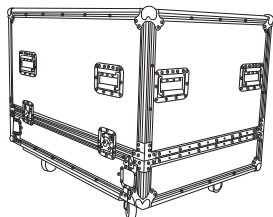

Flightcase
For 2 cabinets,
with 100mm wheels



Dolly(customized)

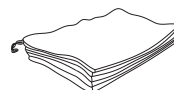

Rain bag
(customized)

Installations

