

Phonitor 2

Headphone Monitoring Amplifier



This User Manual is optimized for Acrobat Reader.

Interactive buttons may not appear in other applications.

User Manual

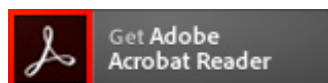

Welcome

and thank you for choosing the Phonitor 2.

The Phonitor 2 is the ultimate headphone monitoring amplifier and delivers up to 3.7 W output power.

The Phonitor 2 is also an excellent preamplifier that can drive power amplifiers or active speakers.

The SPL 120V Rail Technology makes the Phonitor 2 an outstanding device in terms of dynamic range, signal-to-noise ratio and headroom delivering an exceptional sound experience with invincible serenity, transparency and realness.

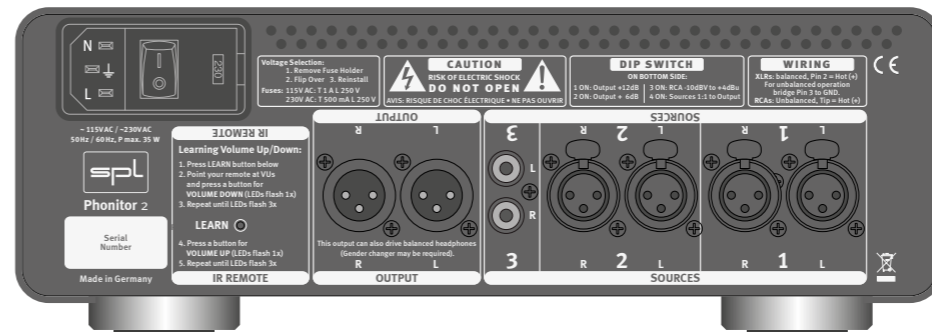

With the optional Expansion Rack you can mount the Phonitor 2 into a 19 inch rack and switch between four different audio outputs (see more information [here](#)).

Content

Getting started	4	Phase Ø	21
Front view	5	Stereo switch	22
Rear view	6	Laterality	22
Bottom view	7	VU meters	23
DIP switches	7	Attenuate the sensitivity of the VU meters	23
120V Rail Technology	8	IR Remote control	24
Comparisons	9	DIP switches	25
Phonitor Matrix	11	Level increase of the outputs	25
Basics of stereo listening	11	RCA input HiFi level / Studio level	25
Stereo listening with an “traditional“ headphone preamplifier	12	Slave Thru	26
How does the Phonitor Matrix work?	13	Phonitor Matrix activation for the XLR outputs	26
Angle	14	Specifications	27
Crossfeed	15	Inputs	27
Setting of Crossfeed and Angle	16	Outputs	28
Adjustment of the Phonitor Matrix	18	Internal operating voltages	30
Matrix On/Off	19	Power supply	30
Source selection	20	Dimensions (incl. feet)	30
Output selection	20	Weight	30
Solo	21	Important Notes	31
		Declaration of CE Conformity	31



Getting started

Read thoroughly and follow the instructions as well as the security advices of the Quickstart which is enclosed in the scope of delivery! You can also download the Quickstart [here](#).

- By pressing the -Button you get to the table of contents.
- By pressing the -Button you get to the front view of the unit.
- By pressing the -Button you get to the rear view of the unit.
- By pressing the -Button you get to the bottom view of the unit.
- By pressing the -Button you get to the previous content.

Front view

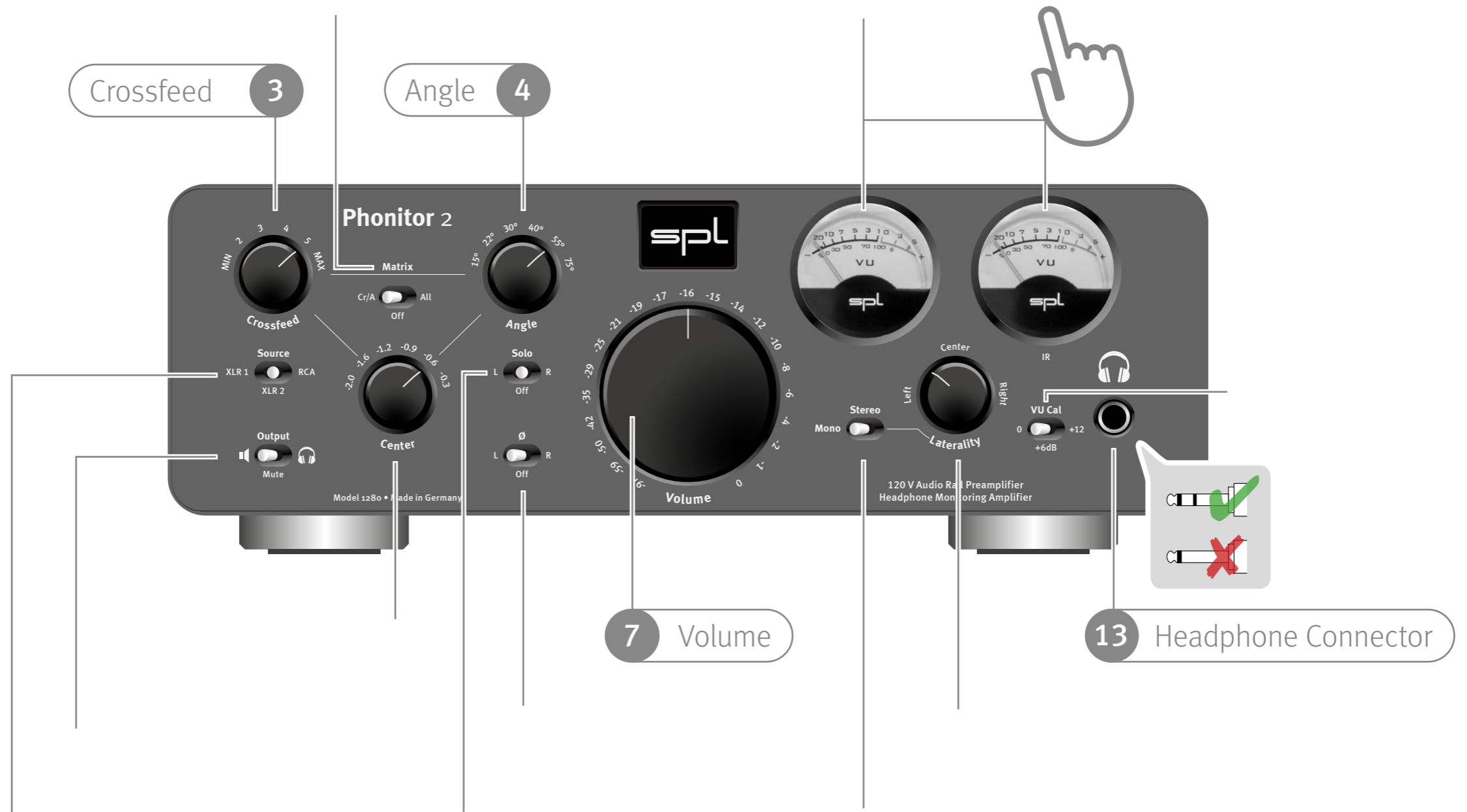

Rear view

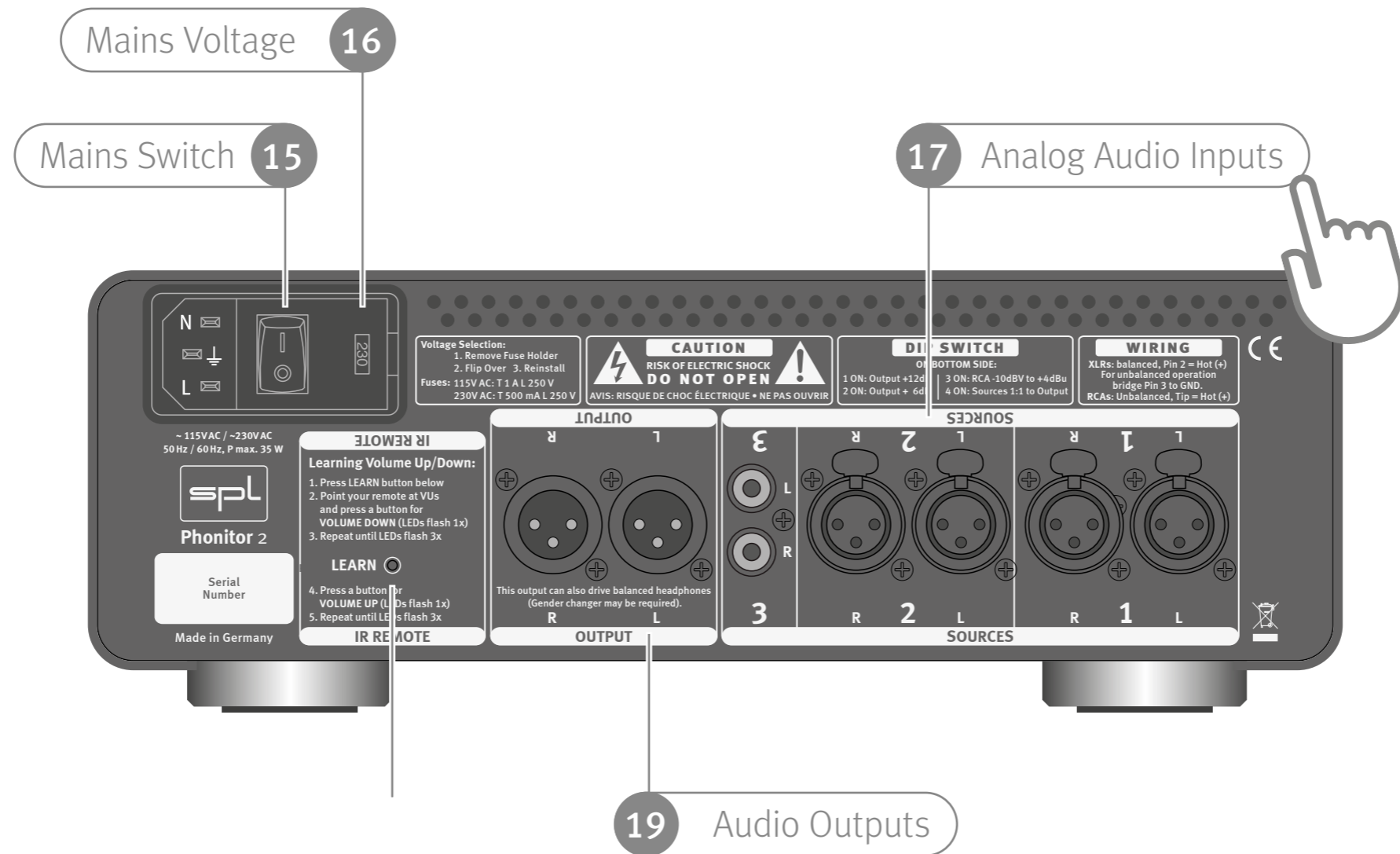

Bottom view

DIP switches

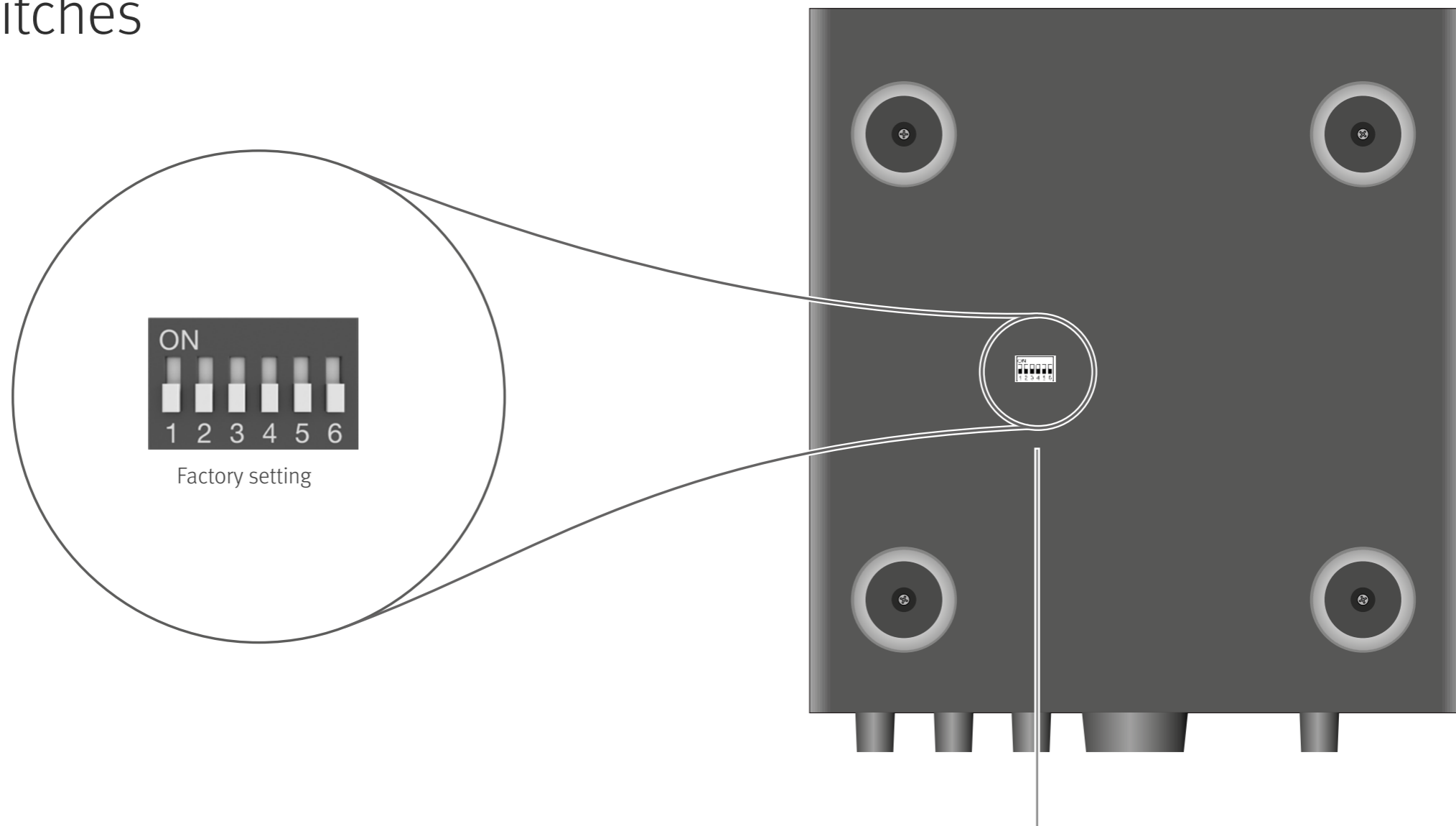

120V Rail Technology

In our 120V Rail Technology the audio signals are processed with an unequalled $\pm 60V$ DC, which corresponds to twice that of discrete operational amplifiers and four-times that of semiconductor operational amplifiers.

The 120V Rail Technology reaches outstanding technical and sonic performances. Technically especially in terms of dynamic range and headroom and sonically especially in reproducing the finest details and delivering a totally relaxed sounding audio experience. Music sounds absolutely natural.

Comparisons

These diagrams show how our 120V Rail Technology compares to other circuits.

The direct relation between operating level and maximum level is fundamental for the classification: the higher the operating level, the higher the maximum level a circuit can handle. And since virtually all essential acoustic and musical parameters depend on this relation, a higher operating voltage also has a positive impact on the dynamic range, distortion limit and signal-to-noise ratio.

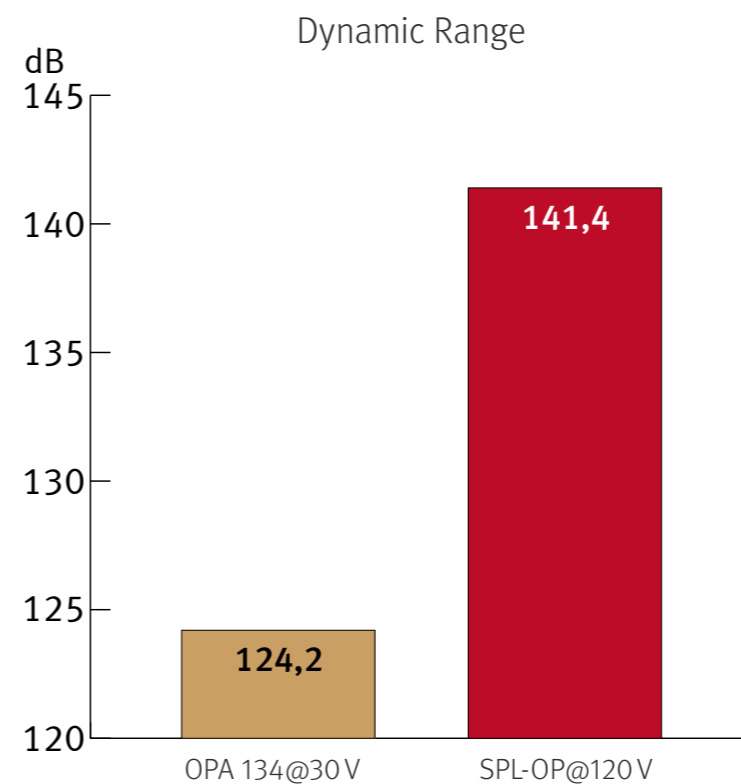
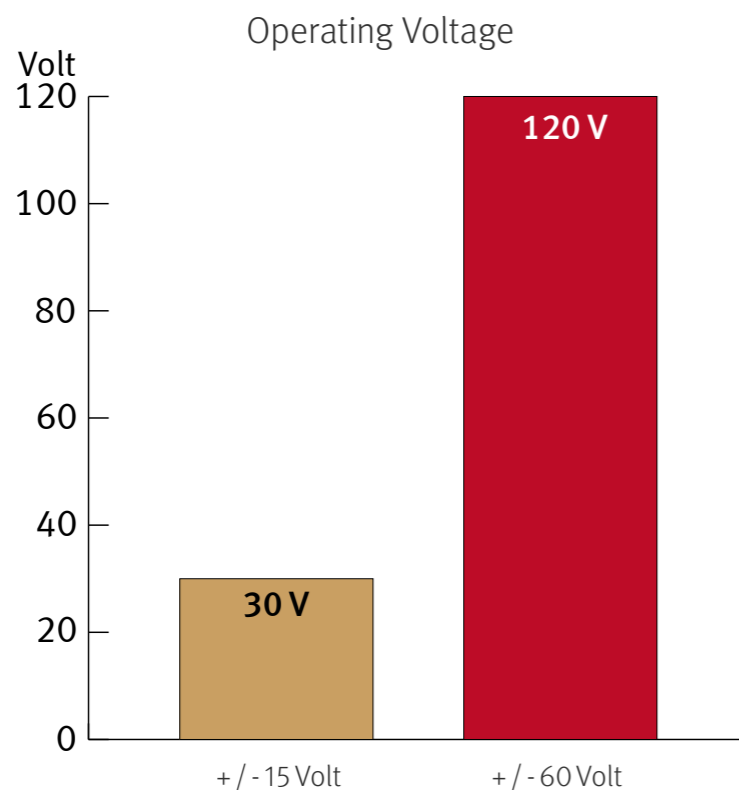

Do bear in mind that dB scales do not represent linear but rather exponential increases. A 3 dB increase corresponds to doubling the acoustic power, +6 dB correspond to twice the sound pressure level, and +10 dB correspond to twice the perceived loudness.

When it comes to volume, the 120V Rail Technology exhibits a performance, in regard to maximum level and dynamic range, that is twice that of common components and circuits given that its values are approximately 11 dB higher.

THD measurements show a difference of more than 8 dB compared to the TL071 at 30 V — in terms of sound pressure level, that corresponds to an improvement of more than 130%. The operating level most commonly used for audio equipment is +/- 15 volts.

Max. Audio Level

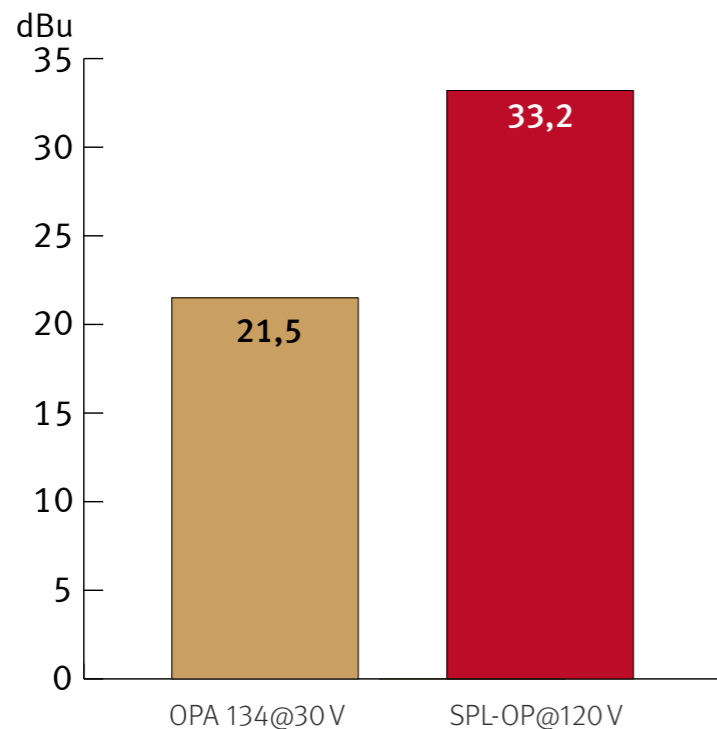

THD&N

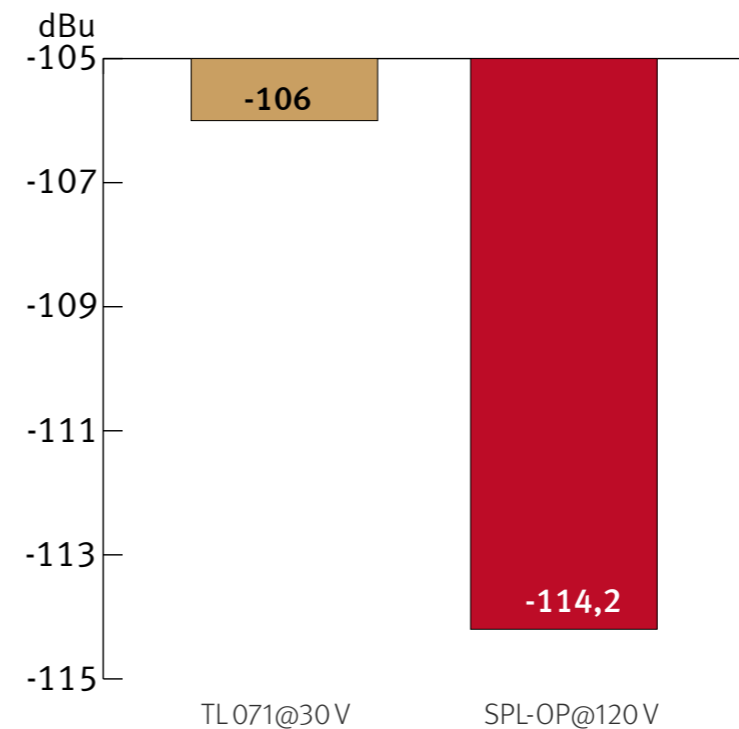

Phonitor Matrix

Basics of stereo listening

When listening to speakers sound coming from the right is not only perceived with the right ear (red line) but it is also perceived with the left ear (green line). The sensation is time delayed, lower in level and has a reduced frequency range (this applies to the left speaker accordingly).

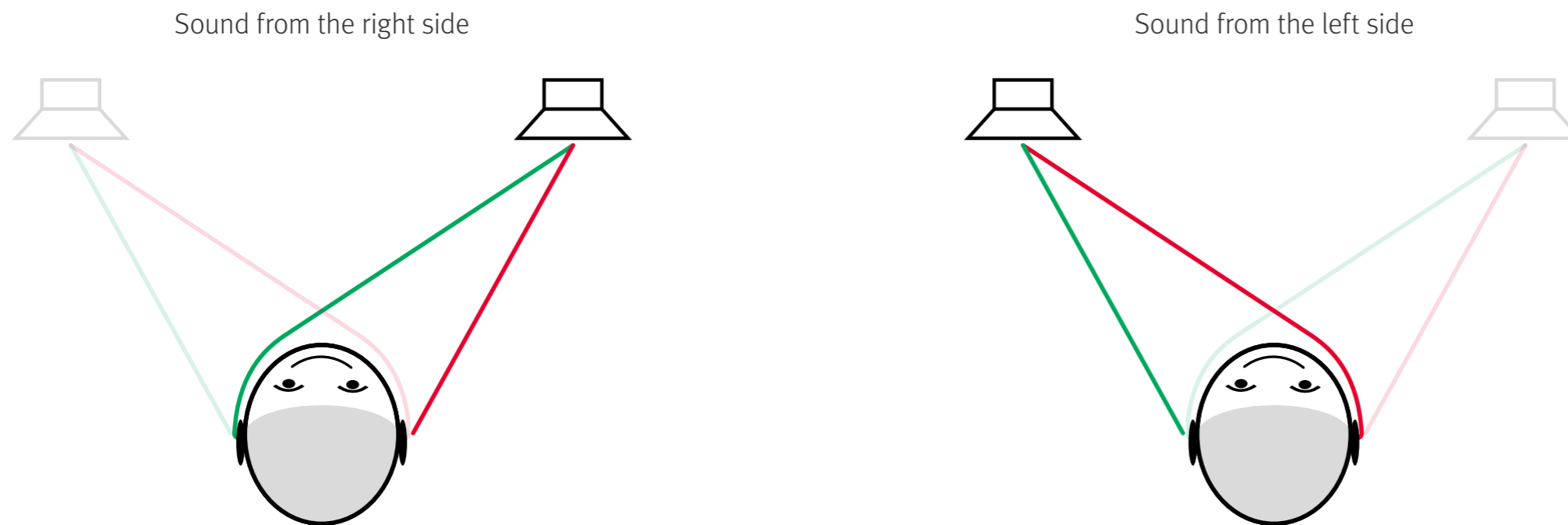

It arrives later because the signal travels a distance of approx. 340 meters per second and the distance from the right speaker to the left ear is longer than it is to the right ear. It is quieter and does not deliver the full frequency range, because the signal of the right speaker does not directly arrive at the left ear but is partially reflected and absorbed by the head.

Stereo listening with an “traditional“ headphone preamplifier

When listening to music with a traditional headphone amplifier, the right ear only perceives the right signal (red line) and the left ear only perceives the left signal (green line).

In contrast to listening to speakers the delayed and quieter signal of the respective opposite side is missing.

As a result to this super-stereo-effect reverb and delay effects as well as EQ and panorama adjustments are perceived more intense on headphones.

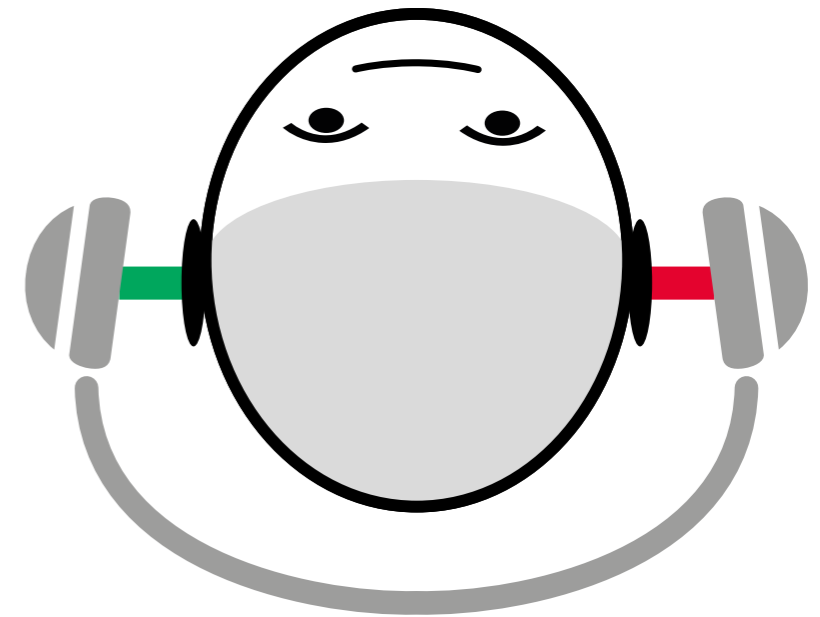

How does the Phonitor Matrix work?

The Phonitor Matrix calculates the interaural time difference (Speaker Angle) and interaural level difference (Cross-feed) with their specific frequency responses to deliver a speaker-like listening experience on headphones.

The super-stereo-effect is eliminated and all reverb and delay effects as well as EQ and panorama adjustments are perceived correctly on headphones.

The headphone mix therefore translates well to speakers.

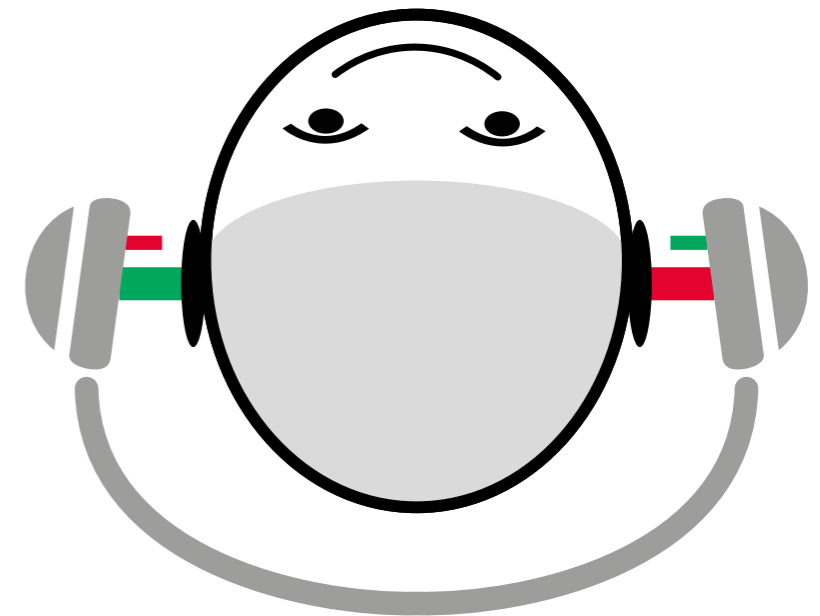

In Detail

An analog filter design creates interaural time and level differences for six different speaker placements. This analog filter design is controlled by the crossfeed and angle parameters.

Angle

With the ANGLE switch you adjust the interaural time difference which is related to the placement of the speakers.

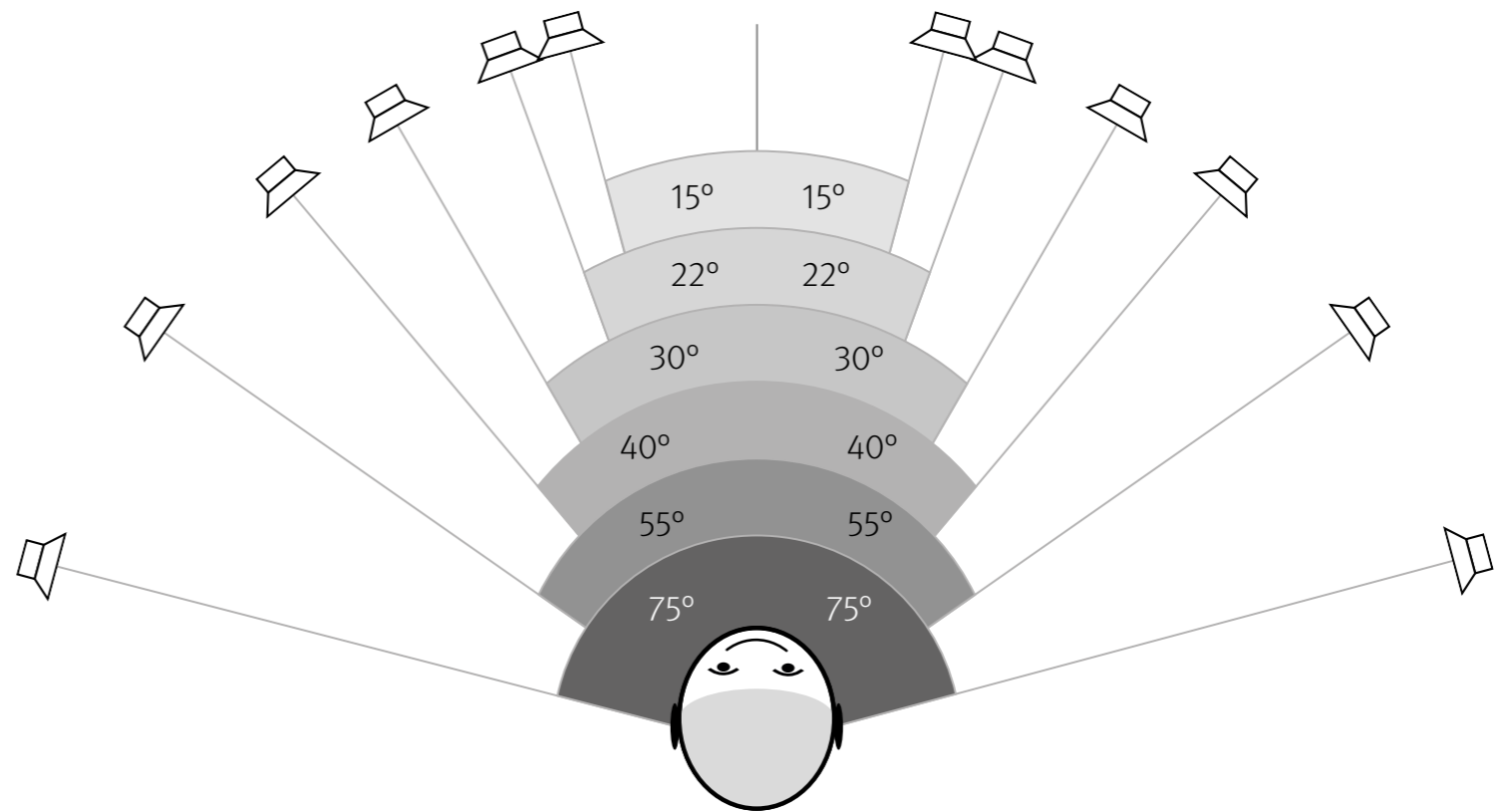

Crossfeed

Crossfeed defines the interaural level difference. The six crossfeed values approximate the influences of room size, reflection and absorption characteristics.

Frequency corrected level difference at max. Crossfeed and 30° Angle of the right channel (red = right signal, green = left signal)

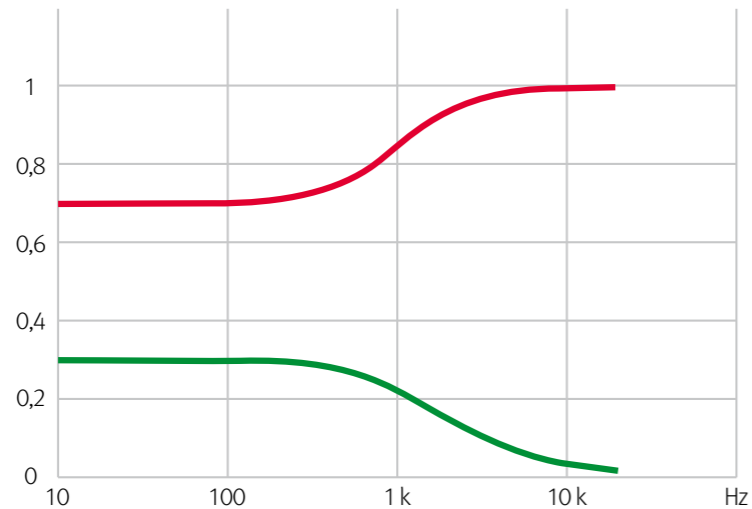

Frequency corrected time difference at max. Crossfeed and 30° Angle of the right channel (red = right signal, green = left signal)

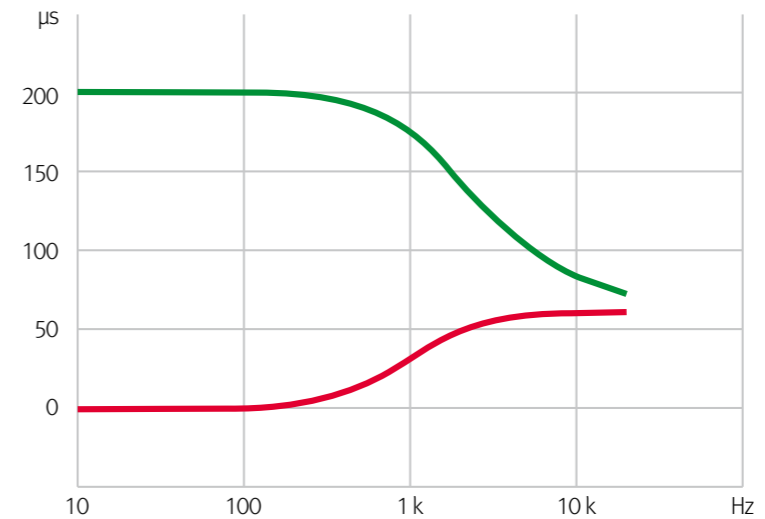

The interaural level difference and the interaural time difference are frequency-corrected because the sound is reflected and absorbed by the head in a non-linear fashion.

Setting of Crossfeed and Angle

Both parameters (Crossfeed and Angle) define the interaural level difference and the interaural time difference. To reproduce the exact placement of the loudspeakers, first choose the Angle parameter closest to your real speaker placement. Afterwards choose the recommended Crossfeed Parameter (see table on [page 17](#), e.g.: Angle: 30°, Crossfeed: 3).

A vast number of factors, e.g. type of loudspeakers, room acoustics or the individual perception, influence the stereo-listening. This is why the Phonitor 2 offers six different switch positions to finely adjust the Crossfeed and to best match to your speaker playback.

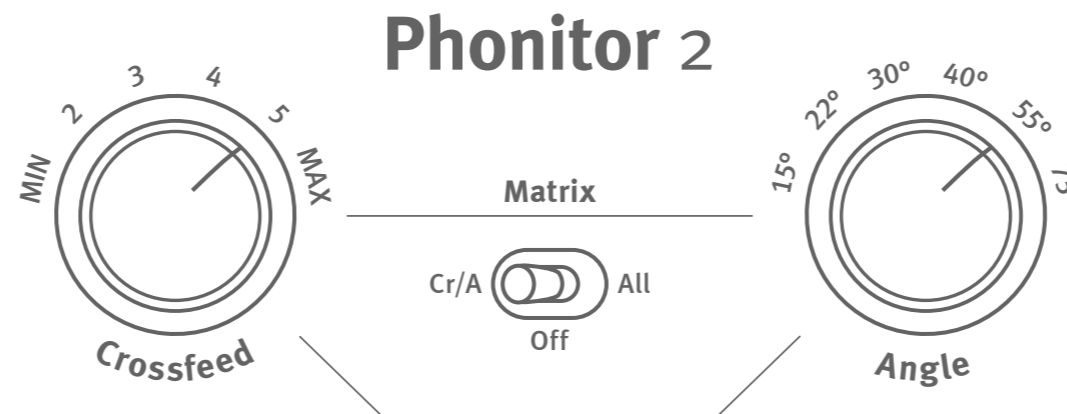

Table: Settings of Crossfeed and Angle

Angle parameter	Crossfeed parameter	Interaural level difference	Interaural time difference (μs)	Speaker angle
15°	MAX	0,03	90	10°
	5	0,06	130	15°
	4	0,08	165	20°
	3	0,12	210	25°
	2	0,16	250	30°
	MIN	0,20	320	35°
22°	MAX	0,24	133	15°
	5	0,35	165	20°
	4	0,40	210	20°
	3	0,47	220	25°
	2	0,50	230	25°
	MIN	0,60	250	30°
30°	MAX	0,40	205	20°
	5	0,49	235	25°
	4	0,56	260	30°
	3	0,64	280	30°
	2	0,70	300	30°
	MIN	0,76	335	40°
40°	MAX	0,26	290	30°
	5	0,34	355	40°
	4	0,40	400	45°
	3	0,49	455	45°
	2	0,50	480	55°
	MIN	0,60	535	70°
55°	MAX	0,34	350	40°
	5	0,44	405	45°
	4	0,50	450	50°
	3	0,58	490	55°
	2	0,52	525	65°
	MIN	0,70	555	70°
75°	MAX	0,31	375	40°
	5	0,40	450	50°
	4	0,44	505	60°
	3	0,54	560	70°
	2	0,60	600	80°
	MIN	0,64	635	90°

Adjustment of the Phonitor Matrix

By using the [Crossfeed switch \(3\)](#) and the [Angle switch \(4\)](#) you can adjust the headphone playback through the Phonitor 2 to your room with your loudspeaker setup.

- Play some audio material you know well with the Phonitor 2 and go to a place where you usually listen to music through speakers.
- Place the Matrix switch in position Cr/A.
- Toggle between headphones and loudspeakers by using the [Output switch \(9\)](#).
- Set the Angle switch according to your loudspeaker placement (see [page 14](#)).
- Then set the Crossfeed switch to the value that comes closest to your familiar loudspeaker-listening sound.

Listen to the instruments panned in the stereo field. These instruments shall have the same positions on headphones.

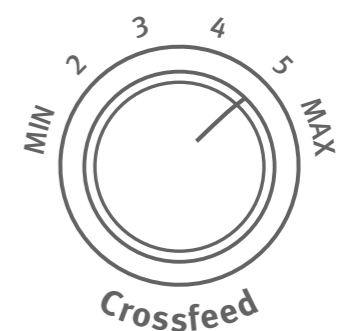
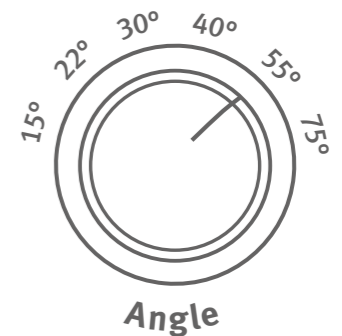
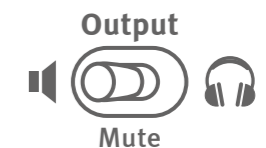

Center function

When activated (Matrix switch = All) you control the intensity of the center signal with the [Center switch \(5\)](#) .

If the stereo width is narrowed through changes in Crossfeed and Angle (so as to correspond to your actual loudspeaker setup), the phantom center may likely sound too intense while mixing under headphones. You normally would counteract by lowering the mid signals in the mix. However, listening to that mix on loudspeakers the phantom center appear to quiet.

Thanks to the possibility to lower the headphone center level of the Phonitor 2 between 0.3 to 2.0 dB you can adjust the center signal to the correct volume in relation to the L/R stereo image. Therefore the phantom center gains the correct volume in relation to the L/R stereo image on loudspeakers too.

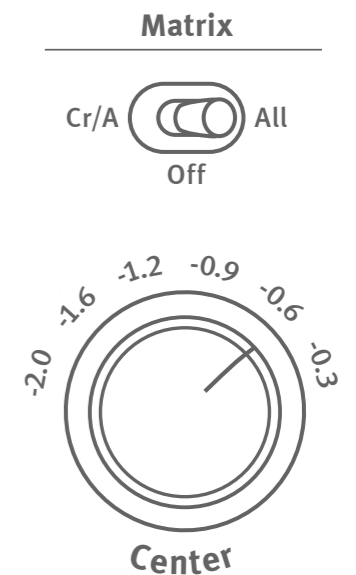

Matrix On/Off

With the [Matrix switch \(2\)](#) you can activate the Phonitor Matrix – with Center control (All) or without (Cr/A). In Off position the Phonitor Matrix is deactivated .

By default the Phonitor Matrix is available for headphone outputs only. The [Speaker Outputs \(19\)](#) at the rear of the unit are not fed by the Phonitor 2 matrix. You can activate the Phonitor Matrix for the speaker outputs at the rear by setting the DIP switch 5 on the bottom of the Phonitor 2 to ON (see ["DIP switches" on page 7](#)).

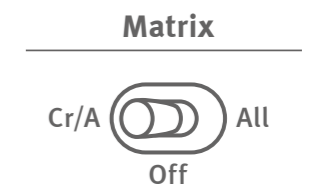

Source selection

The Phonitor 2 is not just a headphone monitor amplifier. It is also a preamplifier three audio sources, XLR 1, XLR 2 and RCA.

The chosen source feeds the headphone output on the front as well as the XLR audio outputs on the rear of the Phonitor 2.

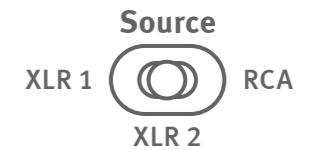

Output selection

With the [Output switch \(9\)](#) you send an input signal to a selected output – headphones or loudspeakers (XLR audio outputs on the rear).



In the Mute position no signal passes through to the outputs. The VU meter are illuminated in red.



Warning: Never connect a mono jack cable to the headphone output (front panel stereo jack). Make sure that the stereo jack is fully inserted, otherwise a short circuit might damage the headphone amplifier!

Solo

With the [Solo switch \(12\)](#) you can monitor the left or right channel of the stereo signal individually.

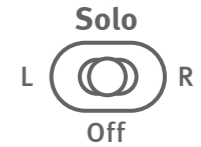

In Off position you hear the stereo signal. Set the Solo switch in position L to hear only the left channel and in position R to hear only the right channel.

With Solo activated you hear the selected channel only on the respective side – this is called “Solo-in-Place”. However, if you like to hear the selected channel on both sides set the stereo switch to mono. E.g. immediately you experience if the mid and high frequencies are similar.

Phase Ø

With the [Phase switch \(11\)](#) you invert the phase of the left or the right channel (180°).

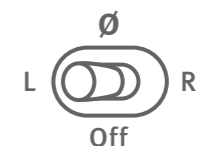

If the Phonitor 2 is set to mono at the same time you hear only the differences of both channels. Therefore you are able to precisely evaluate whether signals are placed in the middle. If the signals are not exactly placed in the middle, you still can hear them.

Stereo switch

By using the [Stereo switch \(10\)](#) you can switch the audio signal to Stereo, Stereo with Laterality control and Mono. In Mono mode, both stereo channels are summed. The mono signal maintains the same loudness, because both stereo channels are each reduced by 6 dB.

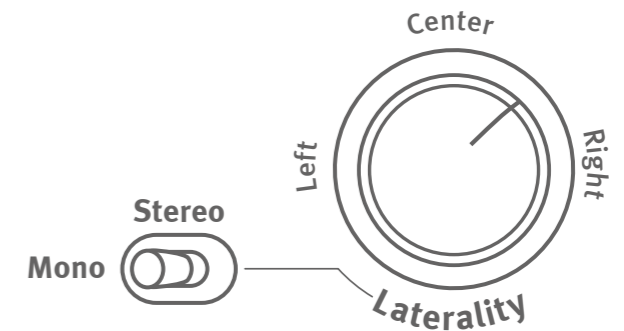

Laterality

Laterality refers to the deviation of sound perception to either side of the ears. With the [Laterality control \(6\)](#) you can compensate perceived volume differences between channels that may be due to a hearing impairment.

This control differs from conventional balance controls. If one channel is attenuated, the other one is increased at the same time. This means that, e.g. when hard left, the level of the left channel increases by 2.25 dB while the right channel is attenuated by 2.25 dB.

This control has a narrower range than conventional balance controls. Its resolution is very fine, which means it can be precisely adjusted.

Set the Stereo switch to Laterality to control the laterality (see above).

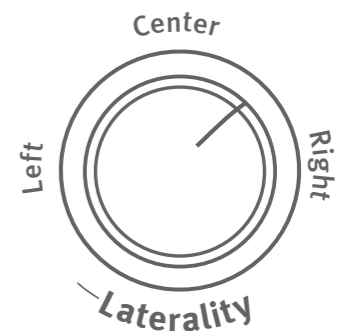

VU meters

The [VU meters \(1\)](#) display the input levels for the selected source. The meter indicates levels from -20 dB to +5 dB. 0 dB corresponds to +4 dBu.

The ballistics of the VU meters guarantee an optimal visual perception. The time calibration of the VU meters complies with the requirements of the BBC. The rise time up to 0 dB is about 300 ms.

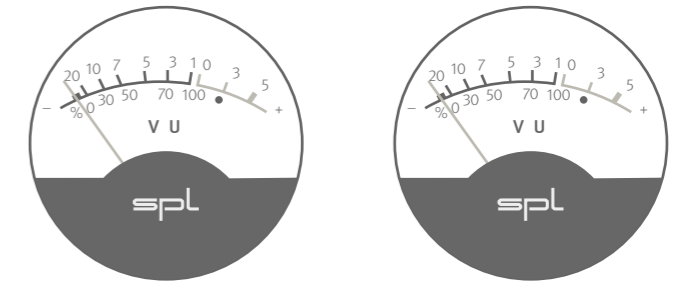

Attenuate the sensitivity of the VU meters

With the [VU Cal switch \(14\)](#) you can lower the sensitivity by 6 or 12 dB so that the meters go up to +17 dB input level if the switch is set to “+12”.

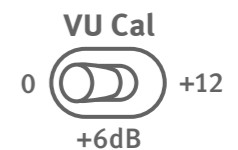

IR Remote control

The volume potentiometer can be remotely controlled using any infrared (IR) remote control.

The special feature is that the Phonitor 2 learns your remote and not the other way around. You do not need a learnable remote control. Take, for example, the remote control of the CD player. Out of the many buttons there are two you hardly use if at all. Assign Volume up / Volume down to these two buttons and let the Phonitor 2 learn them.

- While learning the IR remote control commands set the [Output switch \(9\)](#) to Mute. VU meters light up red.
- Press the [IR REMOTE LEARN button \(18\)](#) on the rear of the unit. The volume potentiometer turns all the way left (you hear the motor of the volume potentiometer running).
- Point your remote control towards the [VU meters \(1\)](#) and push the button you wish to use to **lower the volume**. The motor of the volume potentiometer stops once per push. Press the same button repeatedly until the motor of the volume potentiometer stops three times within a short interval – programming this button is then completed.
- Point your remote control towards the [VU meters \(1\)](#) and push the button you wish to use to **increase the volume**. The motor of the volume potentiometer stops once per push. Press the same button repeatedly until the motor of the volume potentiometer stops three times within a short interval – programming this button is then completed. (Learn mode ends automatically after the second button is learned.)

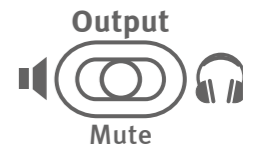

DIP switches

With the [DIP switches \(20\)](#) on the bottom of the unit the following settings can be chosen:

Level increase of the outputs

By using the DIP switches 1 and 2 you can increase the level of the outputs (XLR and headphone).

DIP switch 1: ON = The outputs (XLR and headphone) are boosted to +12 dB.

DIP switch 2: ON = The outputs (XLR and headphone) are boosted to +22 dB.

DIP switch 1 and 2: ON = If both DIP switches 1 and 2 are ON, a boost of +24 dB is applied.

RCA input HiFi level / Studio level

If you connect a HiFi audio device (e.g. a CD player) to the analog [RCA input \(18\)](#), you can amplify the signal from HiFi level to studio level with DIP switch 3.

The sources are then equal in level when you switch between XLR and RCA (provided that a studio signal is present at the XLR input).

DIP switch 3: ON = The RCA input is boosted from -10 dBV (HiFi level) to 0 dBu (studio level).

Slave Thru

By using DIP switches 4 the chosen input passes directly to the XLR output on the rear.

DIP switch 4: ON = The chosen input passes directly to the XLR output without being affected by any control, except Phase inversion). (Slave Thru).

Phonitor Matrix activation for the XLR outputs

With DIP switch 5 the Phonitor Matrix can be activated for the XLR outputs on the rear. This is useful if you want to connect a balanced headphone to the XLR outputs.

DIP switch 5: ON = The Phonitor Matrix is activated for the XLR outputs.

Specifications

Inputs

XLR inputs

- Neutrik XLR, balanced, Pin 2 = (+)
- Impedance: ca. 20 kohms
- CMR: -82 dBu (at 1 kHz)
- Max. Input level: +32.5 dBu

RCA inputs

- Unbalanced
- Impedance: ca. 10 kohms
- Max. Input level: +32.5 dBu

Outputs

Headphone output



Warning: Never connect a mono jack cable to the headphone output (front panel stereo jack). Make sure that the stereo jack is fully inserted, otherwise a short circuit might damage the headphone amplifier!

- 6.35 mm TRS connector
- Pin wiring: Tip = Left, ring = right, sleeve = GND
- Impedance: 0.18 ohm
- Attenuation factor: 180 @ 40 ohms
- Frequency range: 10 Hz to 300 kHz (-3 dB)
- Crosstalk at 1 kHz: -90 dB
- THD & N: 0.00091% (at 0 dBu, 1 kHz, 100 kohms load)
- Noise (A-weighted): -103 dB
- Dynamic range: 134 dB

Max. Output power (at +30 dBu @ 1 kHz)

- 2 x 1 W at 600 Ohm impedance
- 2 x 2 W at 300 Ohm impedance
- 2x 3.7 W at 120 Ohm impedance
- 2x 2.9 W at 47 Ohm impedance
- 2x 2.7 W at 32 Ohm impedance

Line outputs

- Neutrik XLR, balanced, Pin 2 = (+)
- Frequency range: 4 Hz to 300 kHz (-3 dB)
- Crosstalk at 1 kHz: -106 dB
- THD & N: 0.00085 % (at 0 dBu, 1 kHz, 100 kohms load)
- Noise (A-weighted): -104 dB
- Dynamic range: 134 dB

Internal operating voltages

- Analog: +/- 60 V

Power supply

- Mains voltage (switchable): 230 V AC / 50 Hz or 115 V AC / 60 Hz
- Fuses: 230 V: T 500 mA; 115 V: T 1 A
- Power consumption: max 40 VA

Dimensions (incl. feet)

- (WxHxD) 10.94 x 3.94 x 12.01 in (278 x 100 x 305 mm)

Weight

- 9.48 lbs (4.3 kg), unit only
- 11.90 lbs (5.4 kg), shipping

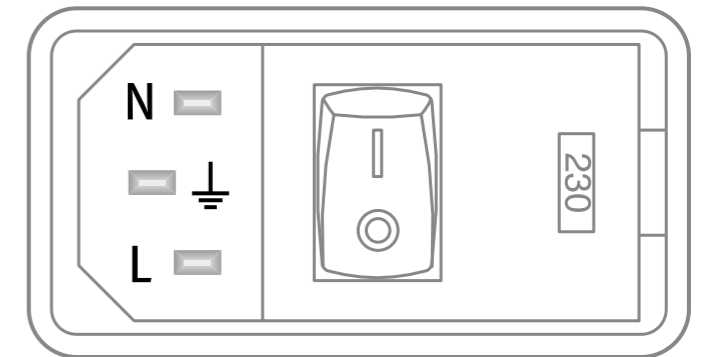

Important Notes

Version 3.1 – 05/2019

Developer: Bastian Neu

This manual includes a description of the product but no guarantee as for specific characteristics or successful results. Unless stated otherwise, everything herein corresponds to the technical status at the time of delivery of the product by SPL electronics GmbH. The design and circuitry are under continuous development and improvement. Technical specifications are subject to change.

© 2016 SPL electronics GmbH. This document is the property of SPL and may not be copied or reproduced in any manner, in part or fully, without prior authorization by SPL. Sound Performance Lab (SPL) continuously strives to improve its products and reserves the right to modify the product described in this manual at any time without prior notice. SPL and the SPL Logo are registered trademarks of SPL electronics GmbH. All company names and product names in this manual are the trademarks or registered trademarks of their respective companies.

Declaration of CE Conformity

 The construction of this unit is in compliance with the standards and regulations of the European Community.