



MV88plus Stereo USB Micro- phone

Shure MV88+ Stereo USB Microphone

The Shure digital USB microphone, MV88+ Stereo USB, user guide.
Version: 1.0 (2021-J)

Table of Contents

MV88plus Stereo USB Microphone Shure MV88+ Stereo USB Microphone	3	Limiter	11
General Description	3	Compressor	11
Features	3	High Pass Filter	12
Quick Setup	3	Left-Right Channel Swap	12
Windscreen	4	Equalizer	12
The MV88+ Microphone	4	Streaming Tips	12
Microphone Orientation	4	Control your Levels	12
MV88+ Outputs	5	Use Lock Mode to Lock In Your Sound	12
Aiming the Microphone	5	Monitor Your Sound	12
Audio Recording	6	Troubleshooting	12
Audio Interview (Tabletop)	6	Firmware Update	13
Handheld Recording	7	Keep equipment connected during updates	13
The Shure MOTIV Desktop App	7	System Requirements	13
Mic Setup	8	System Requirements and Compatibility: Mac	13
Preset Modes	9	System Requirements and Compatibility: Windows	14
Custom Presets	9	System Requirements and Compatibility: iOS	14
Polar Pattern Selection (Stereo and Mono Settings)	10	System Requirements and Compatibility: Android	14
Monitor Mix Blend	11	Specifications	14
Advanced Mic Settings	11	Certifications	16
		Information to the user	16

MV88plus Stereo USB Microphone

Shure MV88+ Stereo USB Microphone

General Description

The Shure MV88+ is a professional quality condenser microphone that plugs directly into a mobile device using a Lightning[®] or USB-C connector. Two microphone capsules in a Mid-Side configuration provide an adjustable stereo image, suitable for capturing a variety of sources, including music and speech. The ShurePlus MOTIV[™] app allows you to customize your sound with digital signal processing (DSP), preset mode selection, gain adjustment, compression, and stereo width control.

Features

Mid-Side Stereo

Supports the classic mid-side stereo recording technique. Uses coincident cardioid and bidirectional capsules to adjust the stereo width while providing excellent mono capability.

Plug-and-Play Operation

Compatible with iOS, Android, PC and Mac devices.

Note: See <https://www.shure.com/MOTIVcompatibility> for information on supportive Android devices.

Compact and Durable

Lightweight, all-metal construction and small enough to carry anywhere. Like all Shure products, ensures reliability in the field.

Flexible Recording Control with the ShurePlus MOTIV App

The MOTIV recording app controls microphone settings, such as gain, stereo width, and preset modes, and includes the following features:

- Landscape or portrait record options
- Basic audio editing
- Markers for keeping track of audio
- Dark theme for low-light recording situations
- Support for all MOTIV microphones
- Five band equalizer
- Live streaming capability
- Dropbox[™], AirPlay[®] and Bluetooth[®] support
- Factory and custom user presets
- Virtual mic options in demo mode
- Multiple bit depth and sample rate options

Quick Setup

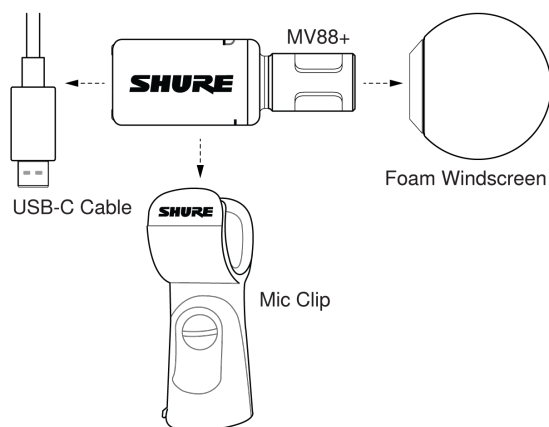

Mounting the Microphone

Windscreen

The windscreen offers maximum protection from plosives and creates a warmer, more intimate sound for speech applications, like podcasting and gaming.

The MV88+ Microphone

The MV88+ features two capsules: one capsule has a cardioid pattern and picks up sound directly in front of the microphone. The other is bidirectional and captures sound from the left and right sides.

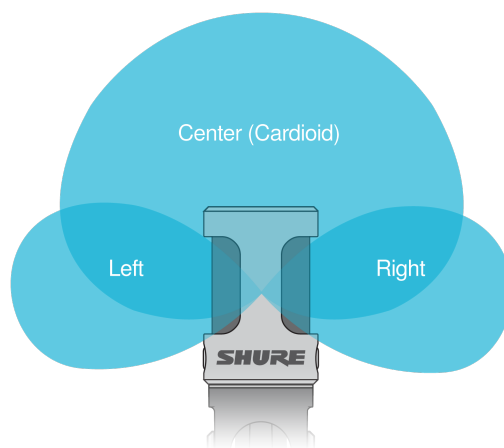

Microphone Cartridge

Microphone Orientation

Rotate the microphone barrel in the mic clip to ensure that your stereo recordings are accurate. Point the front of the microphone toward the sound source. For landscape (horizontal) recording, position the L and R indicators to the right and left. For portrait (vertical) recording, simply rotate the microphone barrel in the mic clip.

Note: The app has a Left-Right Channel Swap to flip the audio channels.

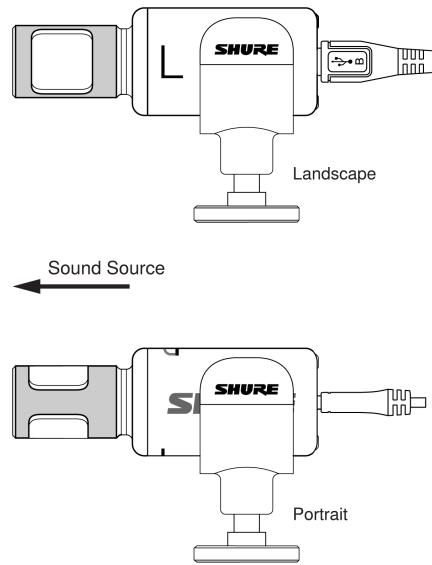

MV88+ Outputs

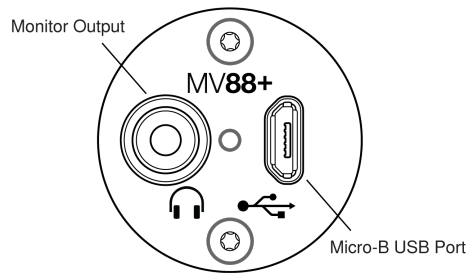

- 3.5mm monitor output for connecting to headphones and earphones
- Send audio to your recording device using the micro-B USB port

MV88+ LEDs

iOS	Android/Mac/PC
Green: Mic active, audio flowing	Green: Power is on
Amber: Error	
Flash Amber: Firmware is updating	
Red: Microphone is muted	
Flash Red: Audio is clipping	

Aiming the Microphone

The following suggestions are for typical use cases. Keep in mind that there are many effective ways to record a source. Experiment to find what works best for you. The MV88+ fits into a standard A25D mic clip. So, you can place it anywhere that you can put a mic stand.

Tip: For correct stereo orientation, ensure that the Shure name is clearly visible on the top of the microphone. If the name is not visible, adjust the microphone accordingly.

Audio Recording

Position your recording device so you can monitor the recording. Aim the front of the microphone toward the source, with left and right sides of the microphone barrel facing the appropriate directions.

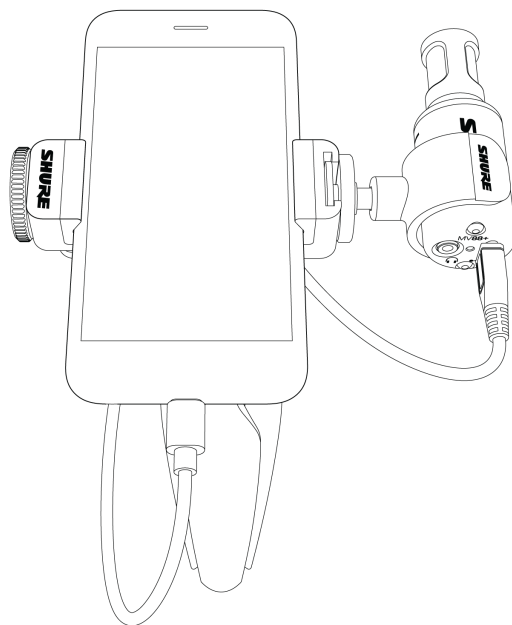

Audio Interview (Tabletop)

Attach the mic clip directly onto the Manfrotto mic stand. Select the MONO BIDIRECTIONAL polar pattern in the MOTIV app. Point one side of the microphone barrel toward the subject and the other toward the interviewer.

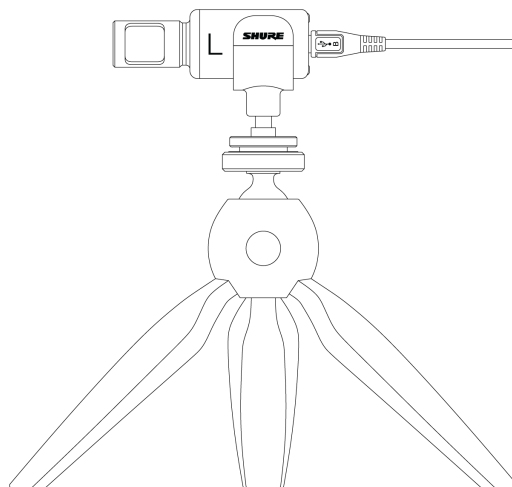

Handheld Recording

The legs collapse to create a portable hand-held stand.

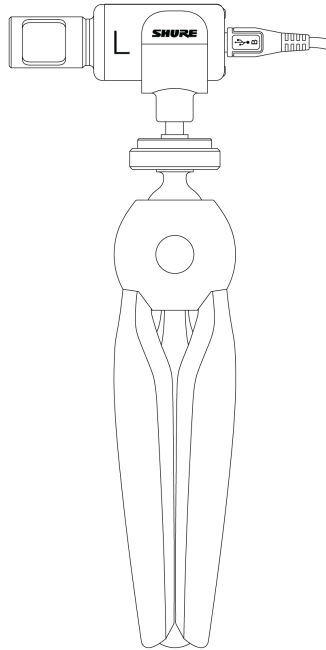

The Shure MOTIV Desktop App

Use the Shure MOTIV desktop app to quickly adjust microphone settings. The device stores the most recently used settings for quick setup.

Mic Setup

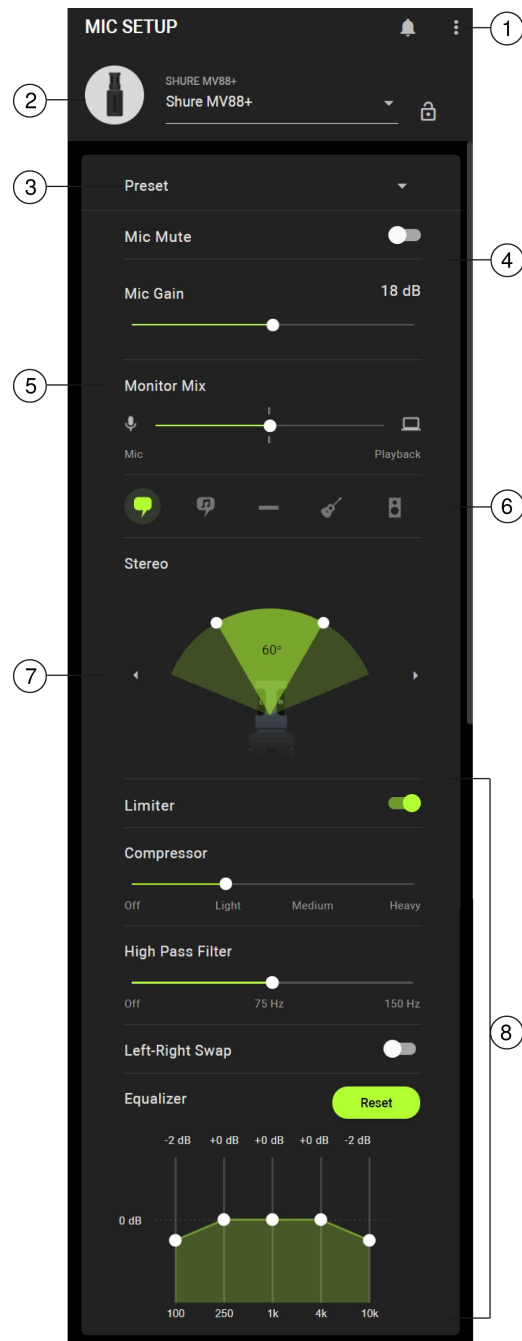

① Settings Click the three dots to access MOTIV software information, manage presets, application preferences and check for firmware updates.

② Mic Selection/Settings Lock Use the drop-down menu to access settings for your microphone. Click the lock to lock and unlock selected settings.

③ Custom Presets Use the drop-down to create your own custom presets.

④ Mic Mute / Mic Gain Use the toggle to mute and unmute your microphone. Use the slider to control microphone gain.

Note: Some programs can control microphone gain while in Manual mode. We recommend locking your mic settings once you have it set the way you'd like.

⑤ **Monitor Mix slider** Move the slider to adjust the levels of mic and playback sound sources. See "Monitor Mix Blend" for more information on monitoring.

⑥ **Preset Modes** Set stereo width, equalization, and compression for specific applications. See "Preset Modes" for more information.





⑦ **Polar Pattern Selection** Swipe to choose your pick-up pattern. Use the dots (handles) to adjust the width of the stereo image.

Tip: Consider the location of the microphone and the size of the sound source when adjusting the width. For example, speech benefits from a narrow width, which improves clarity and rejects ambient (room) sound. Use the dots to quickly set stereo width.

⑧ **Advanced Features** Fine tune your audio recording with limiter and compressor controls, high pass filter, left-right swap, and equalization settings. See "Advanced Mic Settings" for more information.

Preset Modes

Five selectable modes optimize settings for gain, stereo width, equalization, and compression. Set the microphone level and try the modes to find which sounds best. Preset modes can affect the strength of the input signal, so adjust the microphone level as needed after changing presets.

Mode	Application	Characteristics
 Speech	speech	Narrow stereo width to reject background noise, equalization that emphasizes clarity and fullness, and gentle compression.
 Singing	solo or group vocal performances	Medium stereo width with subtle equalization to add richness and clarity for a natural sound.
 Flat	any	An unprocessed signal (no equalization or compression settings used). Adds flexibility when processing the audio after recording.
 Acoustic	acoustic instruments and quiet music	Medium stereo width with transparent compression to smooth out volume spikes and bring out quiet passages. The equalizer setting emphasizes detail and an overall natural sound.
 Loud	live performance and louder sources	Wide stereo to increase separation between sources. Equalization further improves definition by reducing frequencies that can make the instrumentation sound crowded.

Custom Presets

Create and save custom presets to quickly access frequently used mic settings.

1. Start with the preset mode that best suits your application needs.
2. Adjust advanced settings, like compression, for clarity and consistency.
3. Tap Save to rename your preset, or use the default name.
4. Custom preset is added to your list.

To access saved presets:

1. Tap the caret (arrow) in the Preset row to view your list of saved presets.
2. Tap custom preset and Apply Preset to instantly apply gain, stereo, equalization, and compression preferences.

Tip: You can save a custom preset at any point by tapping Save.

Polar Pattern Selection (Stereo and Mono Settings)

The following demonstrates microphone capsule pick-up patterns. When operating in a mono mode, stereo width is not adjustable.

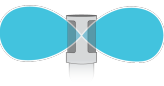
	Stereo	Front = On Sides = On
	Mono Cardioid	Front = On Sides = Off
	Mono Bidirectional	Front = Off Sides = On
	Raw Mid-Side	Front = On Sides = On See "Raw Mid-Side Output" for more information.

Raw Mid-Side Output

For increased post-processing flexibility, use the Raw Mid-Side setting. This records signal a 2-channel signal with a stereo image that can be adjusted even after the tracks have been recorded:

Left: Cardioid (front)

Right: Bidirectional (sides)

Use the Raw Mid-Side setting with audio recording applications that have a mid-side stereo matrix decoder. Or use the manual decoding instructions to adjust the stereo image of the recorded tracks.

Manual Decoding and Stereo Width Adjustment

If your digital audio workstation software (DAW) has no mid-side decoder, use these steps to adjust and manipulate the stereo image:

1. Extract the left and right audio signals from the 2-channel Raw Mid-Side file as individual mono tracks.
2. Create 3 blank audio tracks:
 - **First track:** Use the audio signal (front/cardioid) from the **left channel only** as a mono track, panned to the center.
 - **Second track:** Use the audio signal (side/bidirectional) from the **right channel only** as a mono track, panned all the way to the left.
 - **Third track:** Copy the side/bidirectional signal from the second track. Pan this track all the way to the right and **reverse the phase**.
3. Group the right and left side tracks, and set the volume at the same level for simultaneous adjustment. Increasing the volume of the grouped tracks increases the stereo width, while decreasing their volume narrows the width.

Advanced tip: Using compression with a fast attack setting on the grouped tracks keeps transients (the first part of a sound, such as when a drum stick strikes a cymbal) toward the center of the stereo image and allows them to expand within the stereo field as the sound decays.

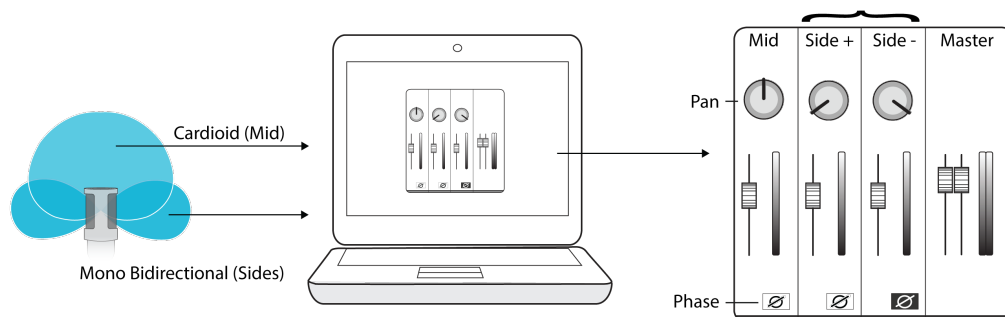

Manual Decoding of Raw Mid-Side Audio

Monitor Mix Blend



Use the monitor mix slider to adjust how much of each source you can hear. For best results, start monitoring at the midpoint and adjust.

- Move the slider towards the microphone icon (Mic) to hear more of the audio going into the mic. Like when you're singing over a recorded guitar track and want to clearly hear your voice.
- Move the slider towards the device icon (Playback) to hear more of the track playing back. When you're recording a harmony to your original vocal track and want to clearly hear the original performance.

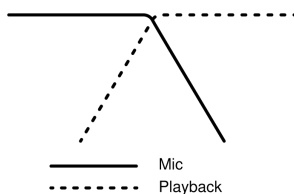

Advanced Mic Settings

After selecting the preset mode, fine-tune your sound with limiter, compressor, and equalizer settings. These settings are retained in the microphone when using other audio and video applications.

Limiter

Toggle the limiter on or off to prevent distortion from volume peaks in your recording.

Compressor

Choose no compression, or select light or heavy compression to control volume when your sound source is dynamic. Quiet signals are boosted and loud signals are lowered.

High Pass Filter

Choose no HPF for the most natural sound. Or select 75 Hz or 150 Hz to reduce wind noise, room noise, or proximity effect.

75 Hz Low frequency cutoff Provides a 6 dB-per-octave cutoff at 75 Hz. Helps eliminate floor rumble and low-frequency room noise from heating and air conditioning systems. This setting may also be used to compensate for proximity effect or to reduce low frequencies that make an instrument sound dull or muddy.

150 Hz Low frequency rolloff Provides a 6 dB-per-octave rolloff filter at 150 Hz. Use this to compensate for proximity effect or to reduce low frequencies that could make an instrument sound dull or muddy.

Left-Right Channel Swap

Use Left - Right Swap to flip the left and right audio channels to match the stereo image to the picture. For example, when using video to record yourself.

Tip: Use the L and R indicators on the microphone barrel to make sure that left and right is accurate.

Equalizer

Change the preset modes to hear the DSP changes, and use the equalizer to boost or cut bands of frequencies to improve sound clarity.

Note: EQ persists between preset mode changes.

Streaming Tips

Control your Levels

To ensure consistent volume levels, keep the microphone as close to your face as possible.

Use Lock Mode to Lock In Your Sound

When you've tested your audio and have found the settings that sound great, press and hold both Mute and Monitor Toggle for 2 seconds to lock and prevent accidental adjustment and ensure that your audio remains consistent.

Monitor Your Sound

To hear your audio, plug headphones into the headphone output on your MOTIV device.

Troubleshooting

Issue	Solution
Microphone is plugged in, but not detected.	Unplug and reconnect the cable so that the app recognizes the microphone. You'll know that the connection is made when you see the MOTIV desktop application display the correct microphone settings.
You hear no audio even though the desktop application is displaying the correct microphone.	Check the Monitor Mix blend. Move the Monitor Mix slider to the center to hear the audio going into the mic and the audio being played back at the same time.

Issue	Solution
Audio is distorted	Audio distortion usually comes from overloading the microphone which causes clipping. Lower your mic gain for the best sound recording.
Left/right stereo channels do not match video.	Depending on the orientation of the recording device, it may be necessary to engage the Left-Right swap in MOTIV settings. If the audio has already been recorded, you can switch the left and right channels in most audio editing software.
Headphone LED flashes. Audio sounds higher or lower pitch than normal.	Your microphone and computer have a sample rate mismatch. To adjust your computer sample rate settings, go to the Shure FAQ topic for information on correcting sample rate mismatch . Note: Windows update 10 v2004 (April 2020) solves this problem.
Miscellaneous issues	It may be useful to reset the app to restore functionality. Perform a hard reset by unplugging and re-plugging the microphone.
General troubleshooting	Quit and re-start the app. Reboot the computer. Check for firmware update. Tap the three dots in the top right corner and select About MOTIV > Check for Update

Note: Contact Shure Service and Repair if you continue to experience any issues.

Firmware Update

Take advantage of additional features and design enhancements by updating the firmware on your MOTIV Desktop Application when prompted. A notification will appear when a firmware update is available. You have the option to download the update immediately or at a later time.

Tip: For best results, before updating the application, make sure that the microphone is connected to your computer. Do not disconnect until the update is complete.

To access firmware update at a later time, tap the three dots > About > Check for Update. Tap the caret icon and if the available firmware package is newer than the current version, tap Send to device. Contact Shure Service and Repair if you experience any issues.

Keep equipment connected during updates

Keep the MOTIV device connected to your mobile device when updating to ensure that there are no update issues.

System Requirements

System Requirements and Compatibility: Mac

- MacOS 10.13 to 10.15
- 64 bit

- Minimum 2 GB of RAM
- Minimum 500 MB of hard disk space

System Requirements and Compatibility: Windows

- Windows 10
- 64 bit
- Minimum 2 GB of RAM
- Minimum 500 MB of hard disk space

System Requirements and Compatibility: iOS

- **iOS:** iOS 12 and higher
- **iPhone:** iPhone 6 and higher
- **iPod Touch:** 6th gen

Note: iPad Pro (USB-C) is not supported.

System Requirements and Compatibility: Android

Will work with any Android device that has:

- Android Oreo 8.0 and higher
- USB Host Power Requirement of ≥ 100 mA
- USB Audio Class 1.1 support and higher

Android is a trademark of Google Inc.

Note: See <https://www.shure.com/MOTIVcompatibility> for information on supportive Android devices.

Specifications

MFi Certified

Yes

DSP Modes (Presets)

Speech/Singing/Acoustic/Loud/Flat

Transducer Type

Cardioid (10 mm)/Bidirectional Condenser Cartridge (10 mm)

Polar Pattern

Adjustable Width Stereo/Mono Bidirectional/Mono Cardioid/Mid-Side

Stereo Principle

Mid-Side

Frequency Response

20 Hz to 20,000 Hz

Adjustable Gain Range

0 to +36 dB

Sensitivity

-37 dBFS/Pa at 1 kHz [1] [2]

Maximum SPL

120 dB SPL [2]

Limiter

Yes

Compressor

Yes

Equalizer

5-band

Power Requirements

Powered through USB or Lightning connector

Housing

All metal construction

Net Weight

Without Windscreen	79.0 g (2.78oz.)
With Windscreen	81.5 g (2.87oz.)

Dimensions

Without Windscreen	27 x 27 x 77 mmH x W x D
With Windscreen	44 x 44 x 93 mmH x W x D

[1] 1 Pa=94 dB SPL

[2]At Minimum Gain, Flat Mode

Bit Depth	Sampling Rate
24	48 kHz
24	44.1 kHz
16	48 kHz
16	44.1 kHz

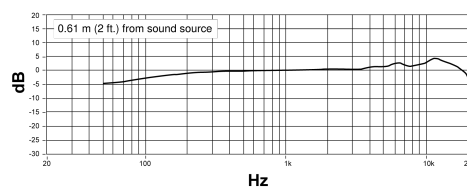

Frequency Response

Certifications

Information to the user

This device complies with part 15 of the FCC Rules. Operation is subject to the following two conditions:

1. This device may not cause harmful interference.
2. This device must accept any interference received, including interference that may cause undesired operation.

Note: This equipment has been tested and found to comply with the limits for a Class B digital device, pursuant to part 15 of the FCC Rules. These limits are designed to provide reasonable protection against harmful interference in a residential installation. This equipment generates uses and can radiate radio frequency energy and, if not installed and used in accordance with the instructions, may cause harmful interference to radio communications. However, there is no guarantee that interference will not occur in a particular installation. If this equipment does cause harmful interference to radio or television reception, which can be determined by turning the equipment off and on, the user is encouraged to try to correct the interference by one or more of the following measures:

- Reorient or relocate the receiving antenna.
- Increase the separation between the equipment and the receiver.
- Connect the equipment to an outlet on a circuit different from that to which the receiver is connected.
- Consult the dealer or an experienced radio/TV technician for help.

This Class B digital apparatus complies with Canadian ICES-003. Cet appareil numérique de la classe B est conforme à la norme NMB-003 du Canada.

Industry Canada ICES-003 Compliance Label: CAN ICES-3 (B)/NMB-3(B)

This microphone for use with any microphone stand with a 5/8" threaded adapter.

Note: Testing is based on the use of supplied and recommended cable types. The use of other than shielded (screened) cable types may degrade EMC performance.

This product meets the Essential Requirements of all relevant European directives and is eligible for CE marking.

The CE Declaration of Conformity can be obtained from: www.shure.com/europe/compliance

Authorized European representative:

Shure Europe GmbH
Global Compliance
Jakob-Dieffenbacher-Str. 12
75031 Eppingen, Germany
Phone: +49-7262-92 49 0
Email: info@shure.de
www.shure.com



Made for iPhone Xs Max, iPhone Xs, iPhone XR, iPhone X, iPhone 8 Plus, iPhone 8, iPhone 7 Plus, iPhone 7, iPhone SE, iPhone 6s Plus, iPhone 6s, iPhone 6 Plus, iPhone 6, iPhone 5s, iPhone 5c, iPhone 5, iPad Pro (10.5-inch), iPad Pro (12.9-inch) 2nd generation, iPad Pro (12.9-inch) 1st generation, iPad Pro (9.7-inch), iPad mini 4, iPad mini 3, iPad mini 2, iPad Air 2, iPad Air, iPad (6th generation), iPad (5th generation), iPad (4th generation), iPod touch.

iPad, iPhone, iPod, and iPod touch are trademarks of Apple Inc., registered in the U.S. and other countries. iPad Air, iPad mini, and Lightning are trademarks of Apple Inc. The trademark "iPhone" is used in Japan with a license from Aiphone K.K.

Android Compatibility

This equipment is compatible with Android devices that support USB Audio Class 2.0 and USB-C connectivity. Not all Android devices are compatible. Android is a trademark of Google Inc.

PIXI[®] and Manfrotto[®] are registered trademarks of Vitec Imaging Solutions. Mini tripod maximum weight: 1Kg/2.2 lbs.

