

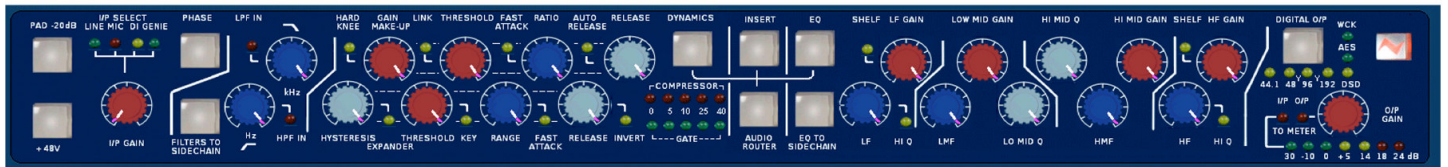

# Neve 8801 Channel Strip User Manual

527 - 358  
Issue 7.6



The 8801 is a combined Mic / Line / Instrument Preamp,  
with Dynamics processing, EQ and Insert point.

The Audio Router function provides a user configurable signal path,  
allowing any order of Dynamics, EQ, and Insert within the channel path.  
In addition, the EQ and/or Filters can be placed in the Dynamics sidechain.

---

**Health & Safety Notice**

---

**For your own safety and for the protection of others,  
please observe the following safety instructions:**

- Read these instructions.
- Heed all safety warnings.
- Do not use near water.
- Clean only with a dry cloth.
- Do not install near heat sources.
- Do not block ventilation openings.
- Protect the power cord.
- Only use accessories specified by the manufacturer.
- Unplug when unused for long periods of time.
- Refer all servicing to qualified personnel only.

**NB:**

This equipment can only be used with the power supply unit provided with it,  
**XP Model Number, AEH130PS36**

## Customer Service

---

In the unlikely event that this unit should malfunction or develop a fault, then please register the fault details on our website, by clicking the link below.

You will also need to enter the unit's serial number when you do this, so please have this to hand.

[http://www.ams-neve.info/crm/fault\\_report.html](http://www.ams-neve.info/crm/fault_report.html)

Once the fault details have been registered, one of our technical support team will be in touch via email.

This link should also be used for further operational or technical help, or any general enquiry about the unit.

### AMS NEVE

Billington Road  
Burnley  
Lancs  
BB11 5UB  
England

Phone +44 (0)1282 457011

Fax: +44 (0)1282 417282

Email: [info@ams-neve.com](mailto:info@ams-neve.com)

Web: [www.ams-neve.com](http://www.ams-neve.com)

Support: [www.ams-neve.info/crm/fault\\_report.html](http://www.ams-neve.info/crm/fault_report.html)

© 2007-2010 AMS Neve Ltd own the copyright of all information and drawings contained in this manual which are not to be copied or reproduced by any means or disclosed in part or whole to any third party without written permission.

As part of our policy of continual product improvement, we reserve the right to alter specifications without notice but with due regard to all current legislation.

**Disclaimer:** The information in this manual has been carefully checked and is believed to be accurate at the time of publication. However, no responsibility is taken by us for inaccuracies, errors or omissions nor any liability assumed for any loss or damage resulting either directly or indirectly from use of the information contained within it.

**Trademarks:** All trademarks are the property of their respective owners and are hereby acknowledged.

# Table of Contents

<b>Health &amp; Safety Notice.....</b>	<b>2</b>	Audio Routing Screen.....	14
Customer Service.....	3	Output Section.....	14
<b>Introduction.....</b>	<b>5</b>	Bargraph LED Meter.....	15
Package Contents.....	5	Overload.....	15
System Requirements.....	5	<b>Rear Panel.....</b>	<b>16</b>
Brief Description & Characteristics.....	6	Rear Panel Audio Connections.....	16
<b>Front Panel Controls.....</b>	<b>7</b>	Line Input.....	16
On/Off Switch.....	7	Mic Input.....	16
Input Section.....	7	DI Input.....	16
Line Input.....	7	Key input.....	16
Mic Input.....	7	Dynamics Sidechain Link.....	17
PAD.....	7	Insert.....	17
Phantom Power.....	7	Line Output.....	17
DI Input.....	7	Headphone.....	17
Digital (Genie) Input.....	8	Rear Panel Power section.....	18
Phase Button.....	8	Warning symbols.....	18
Filters Section.....	8	USB.....	18
High Pass Filter.....	8	Technical Earth Switch.....	18
Low Pass Filter.....	8	Fuse.....	18
Filters to Sidechain.....	8	Power DIN socket.....	18
Dynamics Section.....	8	<b>Optional Digital board.....</b>	<b>19</b>
Dynamics Button.....	8	Analogue to Digital Converter - AES/EBU (AES 3) & DSD.....	19
Dynamics Sidechain.....	9	Sampling Frequency Selection.....	19
Limiter/Compressor.....	9	Digital Sync.....	19
Knee.....	9	Double Rate AES Output.....	20
Link.....	9	DSD.....	20
Attack Time.....	10	Headroom.....	20
Auto Release.....	10	75 Ohm WCLK.....	20
Gain Reduction.....	10	<b>Older Versions of the 8801.....</b>	<b>21</b>
Expander/Gate.....	10	<b>Firmware Upgrades.....</b>	<b>22</b>
Key Input.....	10	Selecting a File for Transfer.....	22
Hysteresis.....	11	File Downloading.....	23
Expander.....	11	Corrupted or Old Firmware.....	23
Invert/Ducker.....	11	<b>Recall Software Installation.....</b>	<b>24</b>
Gain Reduction.....	11	Installation for PC.....	24
EQ Section.....	12	Installation for Mac.....	26
EQ Button.....	12	New Versions of Recall Software for Mac.....	26
EQ To Sidechain.....	12	<b>Other Information.....</b>	<b>27</b>
Low Frequency Band.....	12	Rack Mounting and Cooling.....	27
Low Mid Frequency Band.....	12	Dimensions.....	27
High Mid Frequency Band.....	12	Performance Specifications.....	27
High Frequency Band.....	12		
Insert.....	13		
Audio Router.....	13		
Determining the order of current processing....	13		

## Appendix: A3 Block Diagrams

8801

Optional ADC board installation

## Introduction

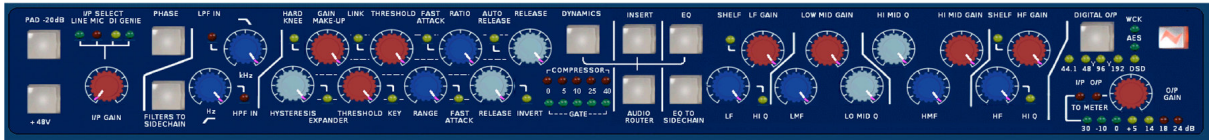

Thank you for choosing the Neve 8801 channel strip.

This unique channel strip is based on the channel strip featured in the world renowned 88R mixing desk.

It contains the highest quality Mic / Line / Instrument Preamp, Dynamics processing, EQ and Insert.

The Audio Router function provides a user configurable signal path allowing any order of Dynamics, EQ, and Insert within the channel path.

In addition, the EQ and or filters can be placed in the Dynamics sidechain.

The configuration of the unit can be stored and recalled via the Neve Recall software on a PC or Mac.

Up to sixteen 88 series units may be connected to a Recall system simultaneously in any combination.

### Package Contents

Please check that your 8801 package contains each of the following:

- 8801 unit
- External power supply
- Power lead
- User Manual CD

### System Requirements

The 8801 may be used as a standalone unit.

If you wish to use the units Recall facility, it should be connected directly to the computer or via a powered USB hub but **not** via a passive USB hub.

If you wish to use the Neve Recall software to store and reload user configurations you must have one of the following supported operating systems:

#### PC:

- Windows 2000, Service Pack 4 or later
- Windows XP, Service Pack 3 or later
- Vista, Service Pack 1 or later
- Windows 7

#### Mac:

- Mac OS 10.3.9 or later

**Brief Description & Characteristics**

---

- High quality transformer coupled microphone preamplifier identical to that used on the 88R console with 0dB to 70dB of gain.
- Switchable Phantom Power.
- 20dB Pad on Microphone and DI inputs.
- Line input with -24dB to +24dB of gain.
- High impedance DI input.
- Phase inversion switch.
- Overload indication at each gain stage.
- High Pass and Low Pass filters switchable between channel path and Dynamics sidechain.
- Dynamics processing based on 88R circuitry.
- Compression/Limiting with auto release.
- Gate/Expander/Ducker.
- Dynamics Sidechain linkable to other 8801 units.
- Key input.
- Compressor and Gate gain reduction meters.
- Balanced switchable Insert.
- 4 band EQ based on the 88R console, switchable between channel path and Dynamics sidechain.
- User definable channel path through Dynamics/Insert/EQ using Audio Router function.
- Line output with +10dB of gain control.
- Headphone output.
- Optional Digital Output Card (AES/EBU/DSD).
- User recall/store current state via Neve Recall software.
- USB link to PC or Mac.

## Front Panel Controls

### On/Off Switch



The Neve Logo Switch on the right hand side of the front panel switches the unit on and off.

The 8801 will always power-up with the same settings as they were when the power was removed (including the order of processing, Phase, Phantom Power, but **not** including any settings on the optional digital card).

Providing no rotary controls have been changed, this ensures that work can continue straight away from power-up without having to recall any of the settings.

If you wish the unit to power up in it's default factory state, hold the **PAD** button down while switching it on.

### Input Section

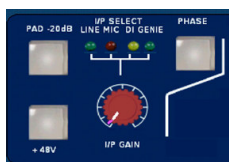

The input is selected by pressing the **I/P GAIN** knob.

This selection is shown on the adjacent Line / Mic / DI / Genie leds.

#### Line Input

The line input is accessible via the rear panel combo connector (1/4" Jack or XLR). It accommodates both balanced and unbalanced input signals.

The Gain is variable from -24dB to +24dB using the **I/P Gain** knob on the front panel.

#### Mic Input

The mic input uses the female XLR input of the front panel combo connector or the female XLR input on the rear panel.

Gain is variable from +20dB to +70dB using the **I/P Gain** knob.

#### PAD

The **Pad** button provides 20dB of gain reduction on the **Mic** and **DI** inputs.

It is not available on the **Line** input.

#### Phantom Power

The **+48V** button enables phantom power on the Mic input.

#### DI Input

The DI input uses the 1/4" jack input of the front panel combo connector or the 1/4" jack input on the rear panel.

The input uses a high impedance instrumentation amplifier (>750k), and accommodates both balanced and unbalanced inputs. The Gain is variable from -24dB to +24dB using the **I/P Gain** knob.

When **Pad** is switched on the input impedance changes to 100k.

### Digital (Genie) Input

The Digital (Genie) input is available via an optional internal daughter card.

The Genie input is only selectable when this optional card is fitted.

### Phase Button

All inputs can be phase reversed using the **Phase** button.

The Phase button will illuminate to indicate a phase inversion between input and output.

## Filters Section

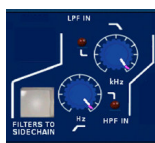

### High Pass Filter

The high pass filter has a 12dB per octave (20dB per decade) slope and a frequency range from 30Hz to 300Hz.

It is switched into circuit by pressing the **High Pass** frequency knob.

The associated led will light to indicate it is in circuit.

### Low Pass Filter

The low pass filter has a 12dB per octave (20dB per decade) slope and a frequency range from 1.5kHz to 18kHz.

It is switched into circuit by pressing the **Low Pass** frequency knob.

The associated led will light to indicate it is in circuit.

### Filters to Sidechain

The **Filters To Sidechain** button puts both filters in the sidechain.

When the filters are in the sidechain they are not available in the channel path and vice versa.

## Dynamics Section



Full Limiter/Compressor and Gate/Expander facilities are available.

The Limiter/Compressor uses the top row of controls and the Expander/Gate uses the bottom row of controls.

### Dynamics Button

The **Dynamics** button activates the Dynamics section.

When illuminated, both Compressor/Limiter and Expander/Gate functions are all in circuit.

When not illuminated both are bypassed.

- To disable the Compressor, set the **Threshold** to **+20dBu** and the **Ratio** to **1**.
- To disable the Gate, set the **Range** to **0dB**.



### **Dynamics Sidechain**

---

The dynamics sidechain is the control signal for the dynamics processing.

By default the sidechain receives the signal picked up at the input of the Dynamics gain stage.

The Filters and EQ can be moved to the sidechain path by pushing the **Filters to Sidechain** and **EQ To Sidechain** buttons respectively.

When in the sidechain the Filters and EQ do not act on the channel path.

When **Key Input** is enabled (by pressing the Gate **Threshold** knob) the sidechain receives the signal from the Key Input located on the rear panel on the D-Type connector.

### **Limiter/Compressor**

---

The Limiter/Compressor has controls for:

- Up to 30dB of gain make-up
- Pressing the **Gain Make Up** knob toggles Hard and Soft Knee
- Threshold has a range of -30dBu to +20dBu
- Pressing the **Threshold** knob selects **Link**
- Ratio of 1:1 to limiting
- Pressing the **Ratio** knob toggles between **Normal** and **Fast** Attack times
- Release times from 30ms to 3s
- Pressing the **Release** knob toggles between **Release** and **Auto Release**

#### Knee

The compressor has soft knee characteristics as default with hard knee available by pressing the **Gain Make Up** knob.

#### Link

**Link** can be selected by pressing on the **Threshold** knob.

When enabled, the compressor section of the unit can be controlled by the sidechain of other linked 8801 units.

For example, this allows a stereo input across two modules to be compressed by the same amount, maintaining the stereo image.

There is no Master/Slave relationship between these signals, the priority is such that the loudest signal is used as the trigger.

Multiple units can be linked together using the rear panel D-Type connector.

Attack Time

Pressing on the **Ratio** knob toggles between **Normal** and **Fast** Attack time.

Two jumpers inside the unit (shown in red below) can be placed so the unit has two variations of attack times.

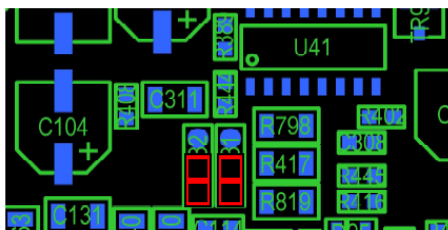

Default Position  
 Normal Attack time: **8ms**  
 Fast Attack time: **2ms**

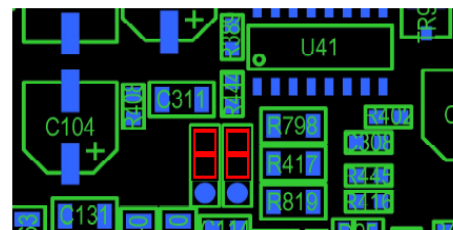

Alternative Position  
 Normal Attack time: **3ms**  
 Fast Attack time: **0.5ms**

Auto Release

Pressing on the **Release** knob switches on **Auto Release** - a triple time-constant, programme dependent release time.

Anti pumping and breathing circuitry allows the unit to operate on the source musically whilst retaining absolute control over the dynamic range.

Gain Reduction

The red meter indicates the gain reduction in dB applied by the compressor.

Expander/Gate

The Expander/Gate has controls for:

- Hysteresis variable from 0dB to 25dB, and pressing the **Hysteresis** knob selects **Expander** mode
- Threshold variable from -30dBu to +20dBu, and pressing **Threshold** knob selects **Key Input**
- Range variable from 0dB to 60dB, and pressing **Range** knob toggles between **Normal** (0.5ms) and **Fast** (0.05ms) Attack times.
- Release time: 10ms to 3s, and pressing **Release** knob selects **Invert** (Ducker)

Key Input

Key input is selectable by pressing on the **Threshold** knob (the key input is on the rear panel combo connector).

When enabled, the sidechain uses the **Key Input** signal rather than the signal picked up at the input of the Dynamics gain stage as the control signal for the Dynamics processing.

### Hysteresis

The **Hysteresis** knob sets the difference in threshold for signals that are rising or falling in level.

Signals that are rising in level turn on when the level reaches the threshold level plus the hysteresis value.

Signals that are falling in level turn off at the **Threshold** level. Raising the threshold for rising signals prevents noise turning the gate on, and also allowing a lower threshold for falling signals to prevent reverb signal tails being prematurely gated.

For example, if the threshold is set at -30 and the hysteresis is set at 10, the signal level would have to rise above -20dB before the channel turns on, and the channel would remain on until the signal level fell below -30dB.

### Expander

Pressing the **Hysteresis** knob switches the gate off and the 2:1 ratio expander on.

The **Expander** led will light to indicate Expander mode.

### Invert/Ducker

Pressing the **Release** knob inverts the behaviour of the Gate.

This function is sometimes called a "ducker".

The **Invert** led lights to indicate that the Gate is in Invert mode.

The function is normally used with an external key input.

When gating, a signal above the threshold level on the key input allows signal to pass; when ducking a signal above the threshold level on the key input causes the gain of the channel signal to be reduced by the amount set on the **Range** knob.

### Gain Reduction

The green meter indicates the gain reduction in dB when the gate is actioned.

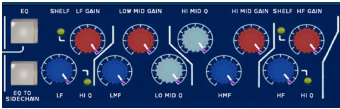

## EQ Section

### EQ Button

The **EQ** button activates the EQ section. When illuminated, the EQ is in circuit, when the led is off the EQ is bypassed.

### EQ To Sidechain

The **EQ To Sidechain** button places the EQ in the sidechain. Placing the EQ in the sidechain removes it from the channel path and vice versa.

### Low Frequency Band

The **LF Gain** knob sets the cut or boost for the low frequency band with a range of +/-20dB.

Pressing the **LF Gain** knob switches the Low Frequency band between **Peaking** and **Shelving** modes.

A led lights to indicate when **Shelving** is selected.

- The LF Hz knob sets the low frequency between 33Hz and 440Hz.
- When the LF band is set to **Peak**, pressing the **LF Hz** knob switches the band between Low (0.7) and High Q (2.0). A led lights to indicate the selection of High Q.
- When the LF band is set to **Shelving** mode, selecting **High Q** has no effect. The High Q led is therefore deactivated and remains unlit.

### Low Mid Frequency Band

- The **Lo Mid Gain** knob sets the cut or boost for the low medium frequency band with a range of +/-20dB.
- The **LMF Hz** knob sets the low medium frequency between 120Hz and 2kHz.
- The **Lo Mid Q** knob adjusts the continuously variable Q between 0.4 and 10.

### High Mid Frequency Band

- The **Hi Mid Gain** knob sets the cut or boost for the high medium frequency band with a range of +/-20dB.
- The **HMF Hz** knob sets the high medium frequency between 800Hz and 9kHz.
- The **Hi Mid Q** knob adjusts the continuously variable Q between 0.4 and 10.

### High Frequency Band

- The **HF Gain** knob sets the cut or boost for the high frequency band with a range of +/-20dB.
- Pressing the **HF Gain** knob switches the High Frequency band between Peaking and Shelving modes. A led lights to indicate when Shelving is selected.
- The **HF Hz** knob sets the high frequency between 1.5kHz and 18kHz. When the HF band is set to **Peak**, pressing the **HF Hz** knob switches the band between Low (0.7) and High Q (2.0). A led lights to indicate the selection of High Q.
- When the LF band is set to **Shelving** mode, selecting High Q has no effect.

The **High Q** led is therefore deactivated and stays unlit.

---

### Insert

The **Insert** button switches the insert into the channel path.

The Insert send and return can be found on the rear panel, the send being a male XLR and the return a female XLR connector.

The 8801 supports both balanced and unbalanced connections.

---

### Audio Router

The **Audio Router** button allows the order of Dynamics, EQ and Insert to be set and interrogated within in the channel path.

The default order is **DYNAMICS / EQ / INSERT**

#### Determining the order of current processing

► To view the current order of the signal path, press the **Audio Router** button once.

The **Dynamics, Insert** and **EQ** buttons will flash in the order they are currently set.

If the EQ is in the sidechain, then the **EQ To Sidechain** button will flash while the **EQ** button is illuminated.

Determining the order of processing is display only, and has no impact on the channel path.

To set a new channel path order:

- Enter programming mode by pressing and holding the **Audio Router** button until it begins to flash.
- Press **Dynamics, EQ** and **Insert** buttons in the order you wish them to be arranged in.
- When the third button has been pressed the **Audio Router** button stops flashing, the new order is stored, the channel's path is updated and the unit returns to normal operation.
  
- While in programming mode, pressing the **Audio Router** button will cancel the programming mode and return to normal operation.

Programming mode will time-out after 15 seconds of inactivity and the unit will return to normal operation without changing the order of the channel path.

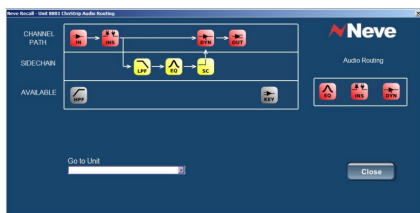

### Audio Routing Screen

When the unit is connected to a computer via USB and the **Recall** software is running, if you right-click on the software title-bar at the top of the screen, a small fly-out menu will give you an option called **Audio Routing** (Mac users: **CTRL** + mouse click).

This enables the various processing items (EQ, DYN, LPF etc.) to be switched in and out of the audio path by dragging and dropping with the mouse from the computer, rather than from updating the order from the front of the unit.

As soon as a new item is inserted in the **Channel Path** or the **Dynamics Sidechain**, the unit is updated accordingly.

Similarly, if the order of processing is changed on the 8801, these changes will be immediately reflected on this screen.

The **Channel Path** is shown on the first row, with the **Side Chain** directly beneath.

All the available (ie bypassed) processing items are shown beneath these two rows.

Items can be switched in three ways:

- ▶ To enable an item, drag it from the **Available** area to the **Channel Path** area.
- ▶ To insert the item into the side-chain, drag it into the **Side Chain** area.
- ▶ To disable an item, drag it into the **Available** area.

On the right of the screen, a panel shows the current order of the processing items, **EQ**, **Dynamics** (Compressor/Gate) and **Insert**.

- ▶ To reorder the **EQ**, **DYN**, **INS** units, drag the icons to their desired position within this panel.
- ▶ To view another **8801 Audio Routing Screen**, use the drop-down menu to select another unit.

### Output Section



The **Line** output is from a male XLR on the rear panel and accommodates both balanced and unbalanced connections.

The output signal is routed to a headphone amplifier and is accessible on the 1/4" jack socket also on the rear panel.

The signal level for both the XLR line output and the headphone output is controlled by the **O/P Gain** knob. It has a range of between  $-\infty$  to +10dB.

The gain of the headphone output can be increased by moving an internal jumper (**J37**, as shown in red, left)

This jumper is shown here in the High Gain position across the lowest two pins. To swap to the Low Gain setting, put the jumper on the highest two pins.

There is a 6dB difference between the High Gain / Low Gain positions.

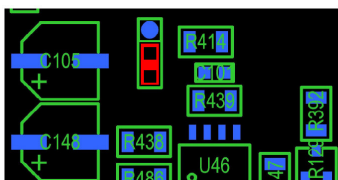

### Bargraph LED Meter

---

The VU meter can be set to display the input or output signal level.

- ▶ Pressing the **O/P Gain** knob toggles between input and output monitoring and the current state is indicated by the led to the left of the **O/P Gain** knob.

The default meter setting is **Input**.

### Overload

---

There are many gain stages in the 8801 channel strip, and it is possible for any one of these stages to overload.

Overloading is indicated by one of the following buttons illuminating red:

<b>PHASE</b>	Input stage or input signal overload
<b>DYNAMICS</b>	Dynamics overload
<b>INSERT</b>	Insert overload
<b>EQ</b>	EQ overload (detected at each band of EQ)
<b>DIGITAL OPTION</b>	ADC Option Board overload

If overloading occurs at multiple stages only the highest priority button will light.

The priority is governed by the signal path of the audio.

The input has the highest priority followed by Dynamics/Insert or EQ in the order set by the **Audio Router**.

**Rear Panel Audio Connections**

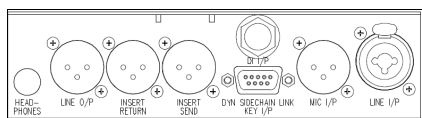

Line Input

The line input combo socket accepts input signals from either male XLR or male 1/4" Jack connectors.

Input signals can be balanced or unbalanced.

Mic Input

The Mic input is on a Female XLR.

This input is in parallel with the XLR input of the Combo connector of the front panel.

DI Input

The DI input is on a 1/4" jack input.

This input is in parallel with the Jack input of the Combo connector of the front panel.

Key input

The key input is located on pins 6, 7 and 8 of the 9 pins D-Type connector.

Input signals can be balanced or unbalanced.

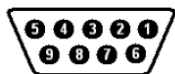

D-Type Pin Outs	
<b>1</b>	Dynamics Link Signal
<b>2</b>	Dynamics Link 0v
<b>3</b>	Dynamics Link Signal
<b>4</b>	Dynamics Link 0v
<b>5</b>	- Not connected -
<b>6</b>	Key Input Hi
<b>7</b>	Key Input Lo
<b>8</b>	Key Input 0v
<b>9</b>	- Not connected -
<b>Case Connected to Unit Chassis</b>	



### Dynamics Sidechain Link

The dynamics sidechain link is available on the 9 pins D-Type connector pins 1-2 and 3-4.

Pins 1 and 3 as well as pins 2 and 4 are in parallel.

Multiple 8801 units can be linked allowing all linked units to be compressed by the same amount.

Multiple units can be linked together by forming a daisy chain of the Dynamics Links.

The diagram below shows how to link 3 units:

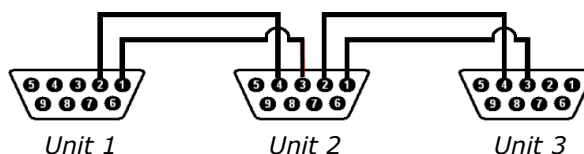

### Insert

The insert send is on a male XLR and the return is on a female XLR connector.

The insert can accept a balanced or unbalanced signal.

### Line Output

The line output is on a male XLR connector.

It can provide balanced or unbalanced output signals.

### Headphone

The headphone output is on a ¼" jack connector.

The level of the headphone output is set by the **Output** Level knob on the front panel.

As the 8801 Channel Strip is a mono channel unit, the headphone receives the same signal on the Left and Right headphone speakers.

## Rear Panel Power section

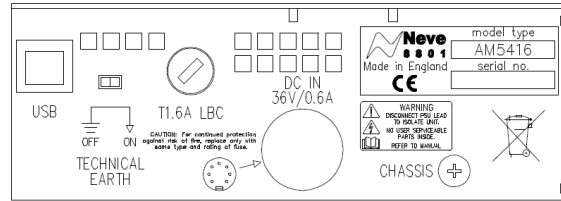

### Warning symbols



There are no user serviceable parts inside the unit.



Disconnect the mains lead to isolate this unit.



Please refer to the manual before operating this unit.

### USB

The Type B USB socket is used to connect the 8801 unit to a PC or Mac for Recall store and recall of the unit settings.

The unit should be connected directly to the computer or via a powered USB hub but **not** via a passive USB hub.

### Technical Earth Switch

The grounding of the unit can be set to two different points:

- 1) The Mains earth from the power supply, or
- 2) The studio technical earth via the **CHASSIS** screw on the back of the unit.

With the switch in the **OFF** position the chassis of the unit is connected to the Mains earth via the power supply.

With the switch in the **ON** position the chassis of the unit should be connected to the studio technical earth using the **CHASSIS** screw on the back of the unit.

For safety reasons the chassis is NOT disconnected from the main Earth but is connected through an RC filter.

### Fuse

The removable fuse holder houses a 1.6 AT fuse.

### Power DIN socket

The 8 pin DIN socket should only be used to connect the power supply provided with the 8801 unit.

### NB:

*For technical reasons the orientation of the socket is the opposite way up, and the "top" of the DIN connector will therefore be underneath. It is not possible to connect the plug the wrong way up.*

**!! WARNING !!**  
**Connections to the technical earth and changes to the grounding of the unit should only be carried out by qualified personnel**

## Optional Digital board

The 8801 has an expansion slot allowing access for digital connectivity.

The digital option available is an Analogue to Digital converter featuring AES/EBU and DSD outputs

*The 8801 ADC board must only be installed by an authorised Neve dealer. Please contact your local Neve dealer for more information.*

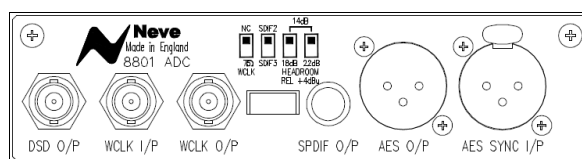

Please see the **Block Diagram** at the end of this document for a signal flow schematic.

### Analogue to Digital Converter - AES/EBU (AES 3) & DSD

The optional AES/EBU & DSD digital daughter board provides the following connections:

- DSD Output
- Wordclock Input and Output
- SPDIF Output
- AES Output
- AES Sync Input

When the Analogue to Digital converter card is fitted the Digital O/P section on the front panel is enabled.

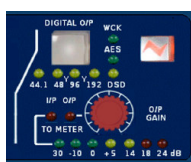

#### Sampling Frequency Selection

The sample rate can be selected by pressing the **Digital O/P** button. This will toggle through the sampling frequencies one at a time.

The current sampling frequency is indicated by the leds beneath the **Digital O/P** button.

#### Digital Sync

The ADC option board has 2 sync inputs, AES 3 on a female XLR and Word Clock on a BNC.

If neither sync input is present, the unit will synchronise to its internal clock.

If either of the sync inputs is present at the sampling frequency displayed on the front panel, the LED (**AES** or **WCLK** respectively) will illuminate green showing that the sync input is being used as a reference.

If the incoming sync sample rate differs from the sample rate displayed on the front panel, the **WCK** or **AES** leds will flash.

If both sync inputs are present and correct the word clock input will be used as the reference and the **AES** led will flash.

### Double Rate AES Output

It is also possible to select 96kHz (or 88.1kHz) sampling rate with a 48kHz (or 44.1kHz) sync input.

Similarly it is possible to select 192kHz (or 176.2 kHz) sampling rate with a 96kHz (or 88.1kHz) sync input.

This will cause the unit to output double rate AES on the AES Output connector.

The sync led will illuminate green indicating the sync reference is still being used for the digital output even though the ADC is sampling at twice the sync input sampling rate.

In this situation AES out carries the odd and even samples of the audio double rate signal on its left and right digital channels respectively.

### DSD

Selecting DSD will default to 44.1kHz reference.  
If no sync is available it will use its own internal clock.

The DSD output is switchable between SDIF 2 and SDIF 3 with a rear panel switch.

SDIF2 DSD data requires an external sync clock which is passed to the Digital to Analogue converter of the receiver.

Preferably use the 8801 Wordclock O/P clock which is available on the back of the 8801 ADC option.

SDIF3 DSD data have embedded clocks and don't require any external sync clock.

*NB: Please refer to your DSD recording device for compatibility information.*

### Headroom

The unit can be set to one of three headroom settings; +14dB, +18dB or +22dB, relative to +4dBu.

The headroom is the number of dBs above +4dBu before the ADC clips.

The **Digital O/P** button will illuminate red if the selected input level is exceeded for more than 1 sample.

The headroom can be changed by accessing the switches on the back of the ADC optional board.

### 75 Ohm WCLK

Selects a 75Ω input impedance for the **WCLK IN**.

## Older Versions of the 8801

This document contains information on the latest production issue of the 8801 unit.

Some earlier versions of the unit contained the following differences:

1 - The **Mic/DI** combo connector on the front of earlier units has now been augmented with separate **Mic** (XLR) and **DI** (Jack) connectors on the rear of the unit as well.

2 - The **Key Input** signal is now handled by a 9-pin connector, and this leaves the old Key Input combo connector on the older model, to be re-used as a **Mic Input XLR**.

3 - The jack socket (used for the **Dynamics Sidechain Linking**) and the combo connector (for receiving the **Key Input** signal), have now both been replaced with a single 9-pin connector that handles both of these services on later models.

The signals for the **Dynamics Sidechain Link** jack socket on earlier models were as follows:

<b>Tip</b>	Dynamic Link Signal	
<b>Ring</b>	0volts	Both <b>Ring</b> and <b>Sleeve</b> are linked internally on the 8801, so either a mono or stereo jack can be used.
<b>Sleeve</b>		

In all other ways, the earlier issue of the 8801 is identical in operation, function and audio integrity as the current production model.

## Firmware Upgrades

In order to get the most from your Neve unit, the latest firmware should be installed.

Upgrading your software is a simple process with on screen prompts to guide you.

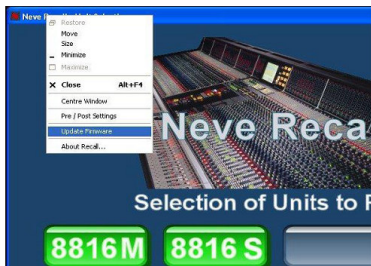

- ▶ Start the **Recall** software.
- ▶ On the main screen, right-click the window title bar (Mac users select **Recalls**)
- ▶ Click **Upgrade Firmware**.
- ▶ Select the file to transfer.

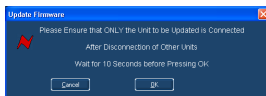

You will be prompted about removing other units.



*When updating units, only the unit that is being updated should be connected via USB. All other units should have their USB disconnected.*

*Even if you are updating two units of the same model, they should be connected individually and updated in two separate operations. If more than one unit is connected via USB when the Update is about to be performed, a screen will prompt you to disconnect the other units.*

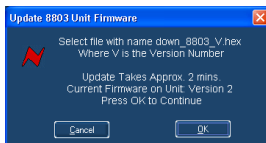

A prompt screen will confirm the software number & version you should select, and display the current version of firmware for the unit.

- ▶ Click **OK**.

### Selecting a File for Transfer

The **Open File** dialog will appear.

To locate the firmware file, browse to the location:

- PC users: C:\Program Files\Neve Recall\Firmware
- Mac users: Applications\Neve Recall\Firmware

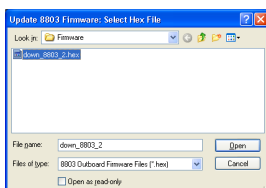

The file names follow the format **down\_88XY\_V.hex** where XY are the last two digits of the 88 unit name (e.g. '16' for 8816) and **V** is the software version number.

A typical filename could be **down\_8804\_3.hex**.

- ▶ Double click on the latest filename which matches your unit.

If an incorrect file is selected the user will be prompted to select another file.

## File Downloading

---

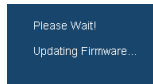

Once the file is selected, the transfer will begin and the Recall screen will display that the download is under way.

This process may take up to two minutes for each unit.

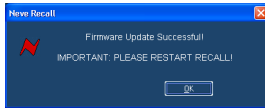

Upon completion, the message **Firmware Update Successful** will be displayed.

► Click **OK** to continue.

You can continue to update other units successfully without restarting Recall, but the Recall software must be restarted once this process is finished.

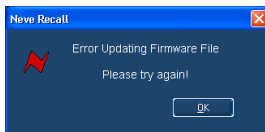

If the transfer fails (for example if the USB is removed by accident or power is lost to the unit), a warning message will prompt to the user to try again.

If Recall is started with a unit that has no firmware, the user will be prompted to upgrade the firmware, as the unit cannot be used in Recall unless the firmware installation is successful.

## Corrupted or Old Firmware

---

If the firmware is corrupted or the unit has an old version of firmware, a prompt will appear upon starting the Recall software to indicate that firmware must be updated before the user can proceed.

The process described above can then be followed to update the latest firmware.

## Recall Software Installation

### Installation for PC

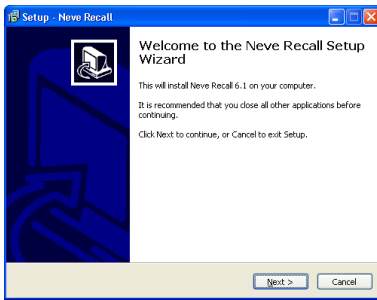

Insert the CD into the drive and the **Setup** program should automatically launch.

If the application fails to launch automatically on inserting the CD, then go to the CD Drive in Windows Explorer and double-click the **NeveRecall.msi** file or the **setup.exe** file to launch the Setup program manually.

► Click **Next**.

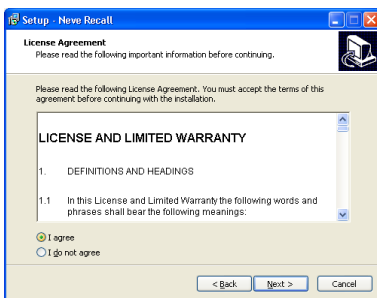

► Click **I Agree**, then click **Next**.

If you click **I Do Not Agree**, the install procedure will terminate.

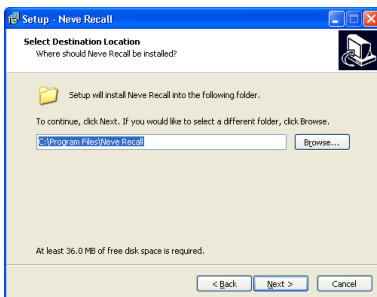

The installation programme will select a default location for files to be copied and created to.

► Click **Next** to keep the default location, or click **Browse** to select another location.

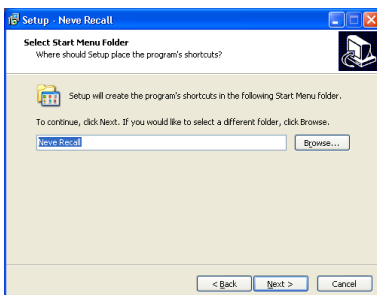

► Click **Next**.

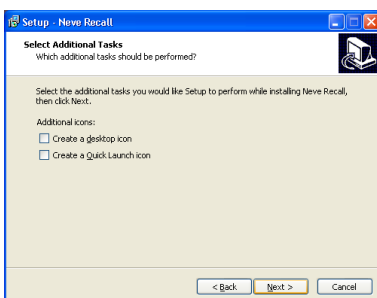

► Tick as desired then click **Next**.



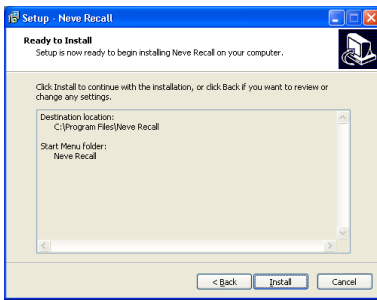

► Click **Install**.

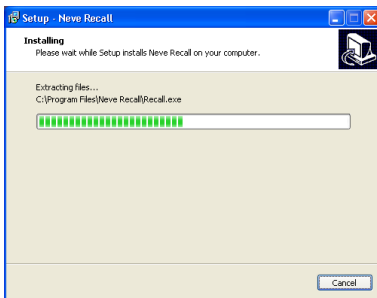

The install will start and the progress displayed.

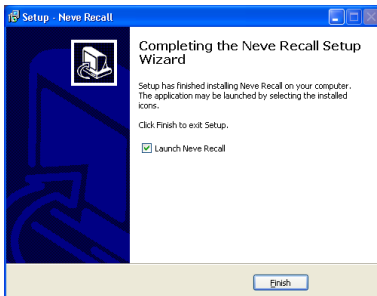

If you wish to launch Recall, tick the **Launch Neve Recall** box.

► Click **Finish**.

The software will now be ready to use, and will be accessible from **Start Menu / Programs / Neve Recall / Neve Recall**, or from the **Recall** icon on the Windows Desktop.

## Installation for Mac



Insert the CD containing the software into the Mac, and the install programme will launch automatically.

► Click **Continue**.



Select the location where you wish the software to be installed to.

► Click **Continue**.

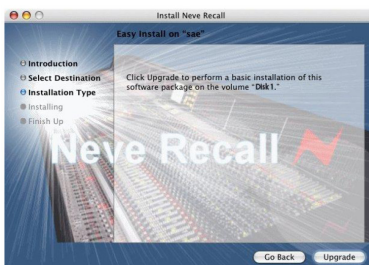

► Click **Upgrade**, and the software will start to install.

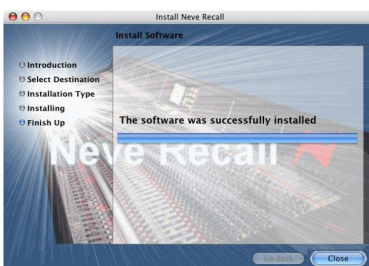

The progress bar will show the state of the installation.

► Once completed, click **Close**.

The software is now ready to use.

## New Versions of Recall Software for Mac

Where you wish to install a new version of the Recall software on a Mac, you will need to uninstall the previous version first and remove some files:

- From the **Applications** folder, move the **Neve Recall** folder to the **Trash**;
- From the **//System Library/Extensions** folder, move **Neve8816.kext** to the Trash (move this file, regardless of the actual outboard units you may have connected via USB)
- From the **//Library/Receipts** folder, move **Neve Recall.pkg** to the Trash.

You will now be able to install the new version.

## Other Information

### Rack Mounting and Cooling

The rack unit should be installed in a 19 inch cabinet with access to the front and rear.

No specific air conditioning is required for the rack provided that there is free flow of air through the rack from front to back and side to side, and that the ambient air is maintained below 25 degrees centigrade.

Units may be stacked, but at least 1U space should be allowed between each unit.

### Dimensions

<b>Width</b>	48.2 cm / 19 inches
<b>Height</b>	4.4 cm / 1¾ inches (1U)
<b>Depth</b>	24 cm / 9½ inches (without power socket plugged in)
<b>Weight</b>	3 Kg / 6.6lbs

### Performance Specifications

<b>Mic input impedance</b>	1.2kΩ
<b>Mic Mic input headroom</b>	+26 dBu (reference 0dBu)
<b>Mic input gain range</b>	0 dB to 70 dB (using pad)
<b>Line input impedance (balanced)</b>	> 20Ω
<b>Line input headroom</b>	+26 dBu (reference 0dBu)
<b>Line input gain range</b>	-24 dB to 24 dB
<b>DI input impedance (balanced)</b>	>750kΩ
<b>DI input headroom</b>	+20 dBu (reference 0 dBu)
<b>DI input gain range</b>	-44 dB to +24 dB (using pad)
<b>Line output impedance</b>	<50Ω
<b>Main output Maximum output</b>	>+26 dBu into 600Ω
<b>Frequency Response</b>	+/- 0.2 dB 10Hz to 20kHz +/- 0.5 dB 10Hz to 40kHz
<b>THD + N</b>	<0.005%
<i>Line Output to Main Output, 20 Hz to 20 kHz, using a measurement window of 10 Hz to 80 kHz</i>	
<b>Line Output to Main Output</b>	<-89 dBu
<b>All audio blocks in circuit</b>	<-80 dBu
<i>All noise measurements made between 20 Hz – 20 kHz using measurement window of 10 Hz – 22 kHz</i>	

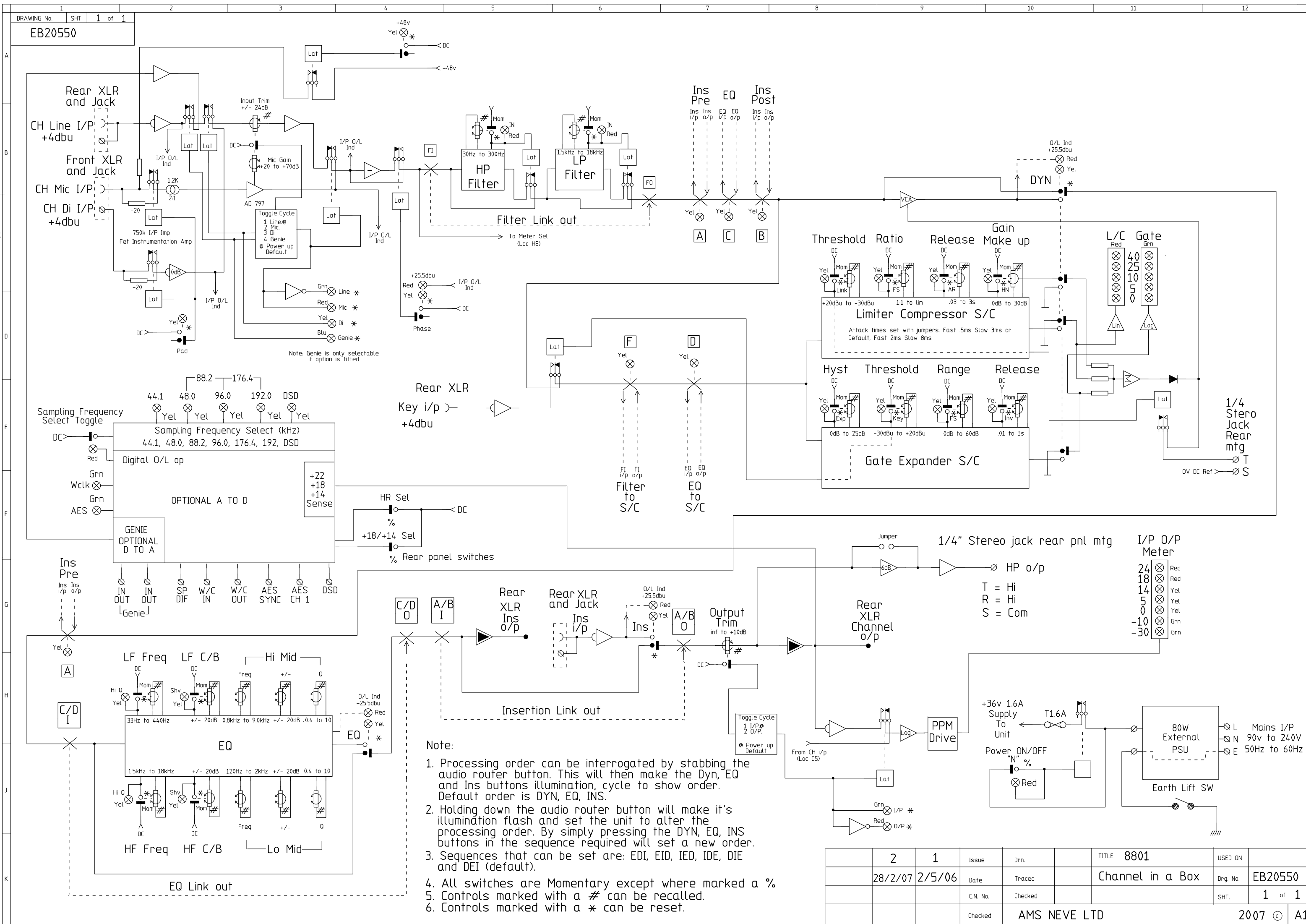

Note: Genie is only selectable if option is fitted

**Note:**

1. Processing order can be interrogated by stabbing the audio router button. This will then make the Dyn, EQ and Ins buttons illumination, cycle to show order. Default order is DYN, EQ, INS.
2. Holding down the audio router button will make it's illumination flash and set the unit to alter the processing order. By simply pressing the DYN, EQ, INS buttons in the sequence required will set a new order.
3. Sequences that can be set are: EDI, EID, IED, IDE, DIE and DEI (default).
4. All switches are Momentary except where marked a %
5. Controls marked with a # can be recalled.
6. Controls marked with a \* can be reset.

2	1	Issue	Drn.	TITLE	8801	USED ON
28/2/07	2/5/06	Date	Traced	Channel in a Box		Org. No. EB20550
		C.N. No.	Checked			SHT. 1 of 1
		Checked	AMS NEVE LTD			2007 © A1

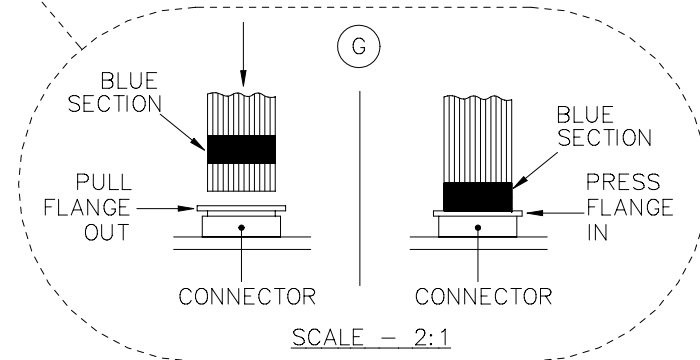
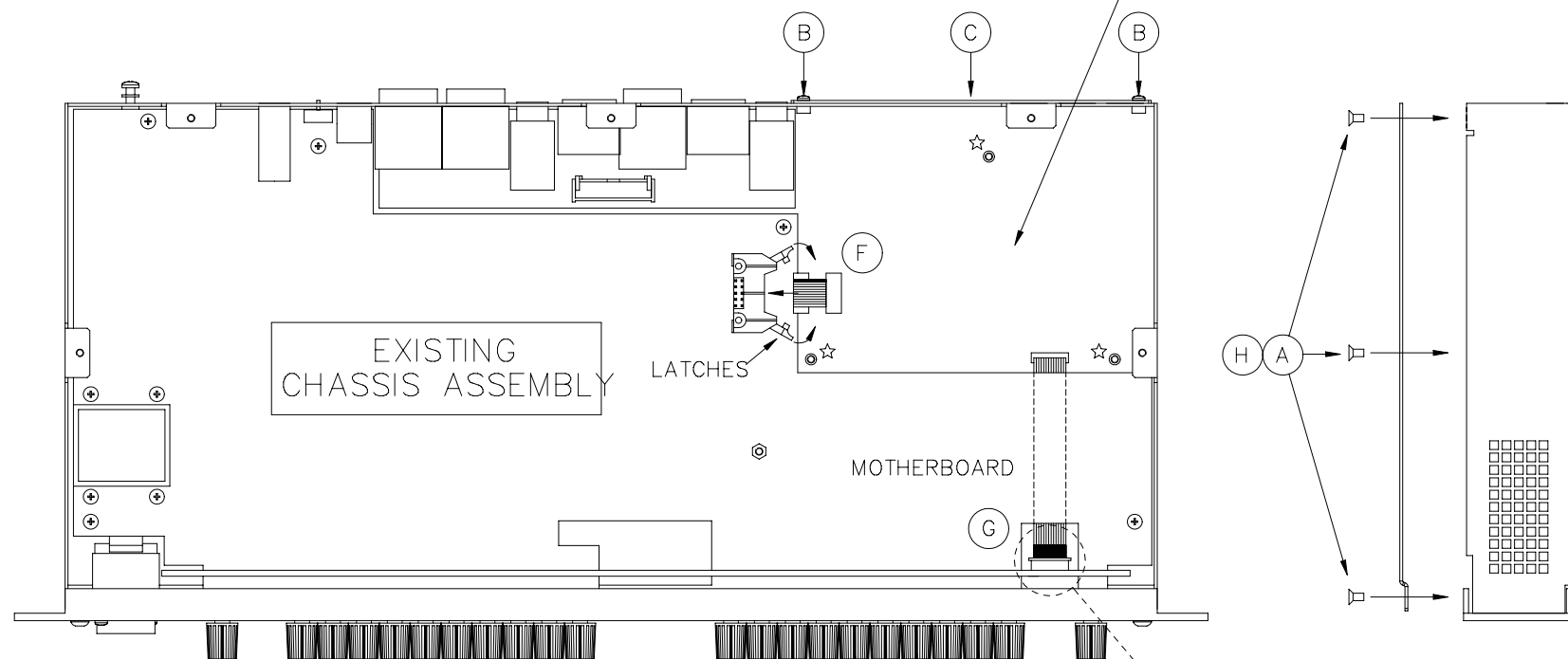
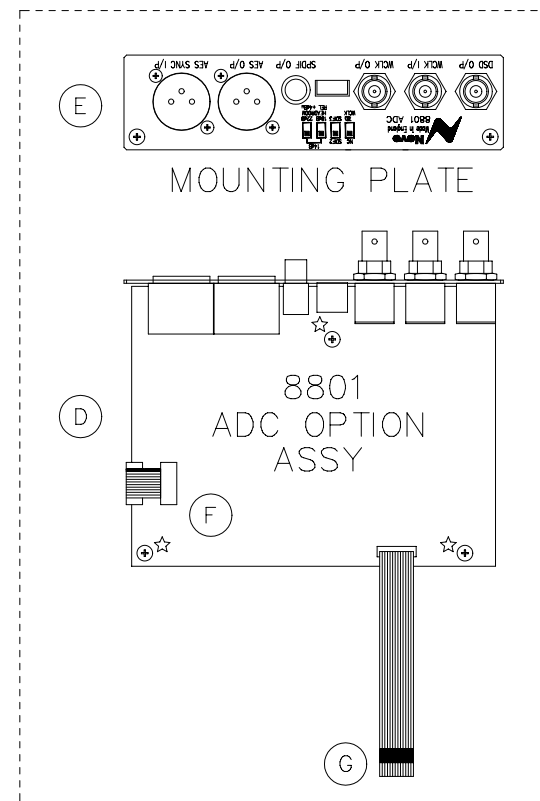

INSTALLATION PROCEDURE	TOOL REQUIRED
(A) REMOVE TOP COVER PLATE & SCREWS FROM THE UNIT & KEEP SAFE TO RE-USE AT ITEM (H)	
(B) REMOVE EXISTING 2off SCREWS & WASHERS - KEEP SAFE TO RE-USE AT ITEM (B)	
(C) DISCARD EXISTING BLANKING PLATE	
(D) FIT "8801 ADC OPTION ASSY" INTO TOP R/H CORNER OF CHASSIS & SECURE USING 3off SCREWS & WASHERS (SUPPLIED) AT POSITIONS MARKED "D"	
(E) SECURE MOUNTING PLATE ONTO THE CHASSIS USING EXISTING SCREWS & WASHERS FROM ITEM (B)	
(F) PUSH L/H CABLE END INTO THE CONNECTOR MAKING SURE THE 2off "LATCHES" LOCK SHUT	
(G) FEED SUPPLIED RIBBON CABLE UNDER MOTHERBOARD & LOCATE END INTO SLOT IN CONNECTOR MAKING SURE THE FLANGE IS PULLED OUT. FEED RIBBON CABLE INTO CONNECTOR UNTIL ONLY BLUE SECTION CAN BE SEEN, PRESS CONNECTOR FLANGE IN TO LOCK CABLE	
(H) RE-FIT TOP COVER PLATE USING EXISTING SCREWS FROM ITEM (A)	

SMW	D38000/SD	30.5.07	2
SMW	----	15.3.07	1
NAME	MOD. No.	DATE	ISS.

THIRD ANGLE PROJECTION  
  
 DRAWN TO B.S.308

AMS NEVE PLC. owns the copyright to this drawing. It must not be copied in whole or in part, used for manufacture or otherwise disclosed without prior written consent of the company.  
 © AMS NEVE PLC.

TITLE: 8801 ADC OPTION ASSEMBLY  
 INSTALLATION INSTRUCTIONS

DRAWN	APP'D	DATE	AMS NEVE PLC. BILLINGTON ROAD, BURNLEY, LANC. BB11 5UB. ENGLAND. TEL. (01282) 457011 FAX. (01282) 417282
SMW		15.3.06	

AMS NEVE

DRG No.	SHT
527-380	2