



User's Guide

DR 500 active series



Antes de utilizar el equipo, lea la sección "Precauciones de seguridad" de este manual. Conserve este manual para futuras consultas.

Before operating the device, please read the "Safety precautions" section of this manual. Retain this manual for future reference.

CONTENTS

SAFETY PRECAUTIONS	3
WARRANTY	4
DECLARATION OF CONFORMITY	5
INTRODUCTION	6
CONFIGURATIONS	7 a 10
LINE DRAWINGS	11
SPECIFICATIONS	11
AMPLIFIER	12 a 14
<u>Description</u>	
<u>ON / OFF</u>	
<u>Overload indicators</u>	
<u>Equalisation</u>	
<u>Overheating</u>	
<u>Low mains voltage</u>	
<u>Current consumption</u>	
<u>Troubleshooting</u>	
APPENDIX	15
<u>Line connections: unbalanced and balanced</u>	

DR-500 active series

Precauciones de Seguridad Safety Precautions



Cajas acústicas activas / Self-powered loudspeaker enclosures

El signo de exclamación dentro de un triángulo indica la existencia de importantes instrucciones de operación y mantenimiento en la documentación que acompaña al producto. Conserve y lea todas estas instrucciones. Siga las advertencias. ATENCIÓN: Es un producto clase A, por lo que en entornos domésticos puede causar radio-interferencias, en cuyo caso el usuario tendrá que tomar las medidas oportunas. De acuerdo con EN55103-2, usar el equipo sólo en entornos E1, E2, E3 ó E4.



No desconecte la tierra en el conector de alimentación pues es peligroso e ilegal. Equipo de Clase I. El producto debe ser conectado a un enchufe con toma de tierra. Sólo use este equipo con el cable de red de alimentación adecuado para su país.

El signo del rayo con la punta de flecha, alerta contra la presencia de voltajes peligrosos no aislados. Para reducir el riesgo de choque eléctrico, no retire la cubierta.



No instale el aparato cerca de ninguna fuente de calor como radiadores, estufas u otros aparatos que produzcan calor. Debe instalarse siempre sin bloquear la libre circulación de aire por las aletas del radiador.

Si los altavoces se utilizan al aire libre en un día soleado, colocar los altavoces en un área sombreada o a cubierto. Los amplificadores de los altavoces tienen circuitos de protección que silenciarán temporalmente el altavoz cuando las temperaturas que se alcanzan sean extremadamente altas. Esto puede suceder en los días calurosos cuando el altavoz esté expuesto a la luz solar directa.

No exponga este equipo a la lluvia o humedad. No use este aparato cerca del agua (piscinas y fuentes, por ejemplo). No exponga el equipo a salpicaduras ni coloque sobre él objetos que contengan líquidos, tales como vasos y botellas. Equipo IP-20.

Este símbolo indica que el presente producto no puede ser tratado como residuo doméstico normal, sino que debe entregarse en el correspondiente punto de recogida de equipos eléctricos y electrónicos.



Equipo diseñado para funcionar entre 15°C y 45°C con una humedad relativa máxima del 95%, con un rango de $\pm 10\%$ de la tensión nominal de alimentación indicada en la etiqueta trasera (según IEC 60065:2001). Si debe sustituir el fusible preste atención al tipo y rango.

El cableado exterior conectado al equipo requiere de su instalación por una persona instruida o el uso de cables flexibles ya preparados.

Si el aparato es conectado permanentemente, la instalación eléctrica del edificio debe incorporar un interruptor multipolar con separación de contacto de al menos 3mm en cada polo.

Para desconectar el dispositivo debe usar el enchufe. Desconecte este aparato durante tormentas eléctricas, terremotos o cuando no se vaya a emplear durante largos periodos.

No emplace altavoces en proximidad a equipos sensibles a campos magnéticos, tales como monitores de televisión o material magnético de almacenamiento de datos.

Para las cajas con vaso para trípode, la altura máxima de seguridad desde el suelo a la base de la caja montada sobre trípode modelo TRD-2, con pies a 55 cm del eje del trípode, es:

DR-508A ----->125 cm
DR-512A ----->115 cm
DR-515A ----->105 cm

El colgado del equipo sólo debe realizarse utilizando los herrajes de colgado recomendados y por personal cualificado. No cuelgue la caja de las asas.

No existen partes ajustables por el usuario en el interior de este equipo. Cualquier operación de mantenimiento o reparación debe ser realizada por personal cualificado. Es necesario el servicio técnico cuando el equipo se haya dañado de alguna forma, como que haya caído líquido o algún objeto en el interior del aparato, haya sido expuesto a lluvia o humedad, no funcione correctamente, haya recibido un golpe o su cable de red esté dañado.

Limpie con un paño seco. No use limpiadores con disolventes.

La reventa del producto sólo es posible incluyendo el manual de usuario. Cualquier cambio producido en el producto tiene que ser documentado por escrito y aprobado por el comprador en el momento de la reventa.

The exclamation point inside an equilateral triangle is intend to alert the users to the presence of important operating and maintenance (servicing) instructions in the literature accompanying the product. Heed all warnings. Follow all instructions. Keep these instructions.

WARNING: This is a class A product. In a domestic environment this product may cause radio interferences in which case the user may be required to take adequate measures.

Use this product only in E1, E2, E3 or E4 environments according to EN55103-2.

Do not remove mains connector ground, it is dangerous and illegal. Class I device. The product must be connected to mains socket outlet with protective earth connection. Only use this equipment with an appropriate mains cord for your country.

The lightning and arrowhead symbol warns about the presence of uninsulated dangerous voltage. To reduce the risk of electric shock, do not remove the cover.

Do not install near any heat sources such as radiators, heat registers, stoves or other apparatus that produce heat. The circulation of air through the heatsink must not be blocked.

If loudspeakers are used outdoors on a sunny day, place the loudspeakers in a shaded or covered area. The loudspeaker amplifiers have protection circuits that temporarily shut the loudspeaker off when extremely high temperatures are reached. This can happen on hot days when the loudspeaker is in direct sunlight.

Do not expose this device to rain or moisture. Do not use this apparatus near water (for example, swimming pools and fountains). Do not place any objects containing liquids, such as bottles or glasses, on the top of the unit. Do not splash liquids on the unit. IP-20 equipment.

This symbol on the product indicates that this product should not be treated as household waste. Instead it shall be handed over to the applicable collection point for the recycling of electrical and electronic equipment.

Working temperature ranges from 15°C to 45°C with a relative humidity of 95%, with $\pm 10\%$ of the rated main voltage value indicated on the rear label (according to IEC 60065:2001). If the fuse needs to be replaced, please pay attention to correct type and ratings.

The outer wiring connected to the device requires installation by an instructed person or the use of a flexible cable already prepared.

If the apparatus is connected permanently, the electrical system of the building must incorporate a multipolar switch with a separation of contact of at least 3mm in each pole.

To disconnect the device, you should use the mains plug. Unplug this apparatus during lightning storms, earthquakes or when unused for long periods of time.

Do not place loudspeakers in proximity to devices sensitive to magnetic fields such as television monitors or data storage magnetic material.

For enclosures with tripod socket, the maximum safety height from floor to bottom of enclosure when mounting on a TRD-2 tripod, with legs spread 55cm from the central pole, is:

DR-508A ----->125 cm
DR-512A ----->115 cm
DR-515A ----->105 cm

The appliance should be flown only from the rigging points and by qualified personnel. Do not suspend the box from the handles.

No user serviceable parts inside. Refer all servicing to qualified service personnel. Servicing is required when the apparatus has been damaged in any way, such as power-supply cord or plug is damaged, liquid has been spilled or objects have fallen into the apparatus, the apparatus has been exposed to rain or moisture, does not operate normally or has been dropped.

Clean only with a dry cloth. Do not use any solvent based cleaners.

Reselling of the product is only possible if the user manual is available. Any changes made to the product have to be documented in writing and passed on to the buyer in the event of resale.

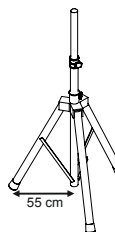

GARANTÍA

Todos nuestros productos están garantizados por un periodo de 24 meses desde la fecha de compra.

Las garantías sólo serán válidas si son por un defecto de fabricación y en ningún caso por un uso incorrecto del producto.

Las reparaciones en garantía pueden ser realizadas, exclusivamente, por el fabricante o el servicio de asistencia técnica autorizado.

Otros cargos como portes y seguros, son a cargo del comprador en todos los casos.

Para solicitar reparación en garantía es imprescindible que el producto no haya sido previamente manipulado e incluir una fotocopia de la factura de compra.

WARRANTY

All D.A.S. products are warranted against any manufacturing defect for a period of 2 years from date of purchase.

The warranty excludes damage from incorrect use of the product.

All warranty repairs must be exclusively undertaken by the factory or any of its authorised service centers.

To claim a warranty repair, do not open or intend to repair the product.

Return the damaged unit, at shippers risk and freight prepaid, to the nearest service center with a copy of the purchase invoice.



DECLARACIÓN DE CONFORMIDAD DECLARATION OF CONFORMITY

D.A.S. Audio, S.A.

C/ Islas Baleares, 24 - 46988 - Pol. Fuente del Jarro - Valencia. España (Spain).

Declara que la *serie activa de DR-500*:

Declares that *active DR-500 series*:

Cumple con los objetivos esenciales de las Directivas:

Abide by essential objectives relating Directives:

- Directiva de Baja Tensión (Low Voltage Directive) 2014/35/UE
- Directiva de Compatibilidad Electromagnética (EMC) 2014/30/UE
- Directiva RoHS 2011/65/UE
- Directiva RAEE (WEEE) 2012/19/UE

Y es conforme a las siguientes Normas Armonizadas Europeas:

In accordance with Harmonized European Norms:

- EN 60065:2014.- Audio, video and similar electronic apparatus. Safety requirements.
- EN 55032:2012.- Electromagnetic compatibility of multimedia equipment. Emission requirements.
- EN 55103-2:2009.- Electromagnetic compatibility. Product family standard for audio, video, audio-visual and entertainment lighting control apparatus for professional use. Part 2:Immunity.
- EN 50581:2012.- Technical documentation for the assessment of electrical and electronic products with respect to the restriction of hazardous substances.

INTRODUCTION

The *DR 500 active series* products are a series of powered, light-weight systems which sport an attractive design. Offering configurations using 8", 12" and 15" loudspeakers, they allow the user to choose the size that best suits any application requiring a complete sound reinforcement solution. Solo musicians, keyboard based groups, or applications such as recitals and conferences will benefit from the unique features of the *DR 500 active series*.

Características

DR-508A

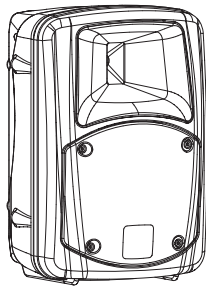

- Powered 2-way, full range system
- 8" bass loudspeaker
- Compression driver with titanium diaphragm
- Multiple mounting options
- Stand mountable

The DR-508A is a powered full-range system that uses a new 8" low frequency transducer. The M-34 compression driver handles high frequency reproduction.

The 1000 W peak power Class D amplifier provides extended bandwidth, improved dynamic range and exceptionally low distortion. This makes the DR-508A one of the smallest and most powerful portable cabinets on the market.

DR-512A

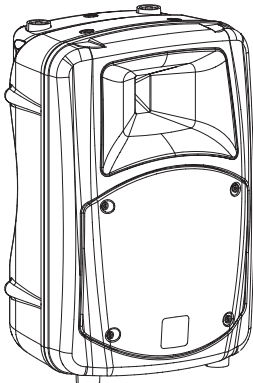

- Powered 2-way, full-range system
- 12" bass loudspeaker
- Compression driver with titanium diaphragm
- Multiple mounting options
- Stand mountable

The powered DR-512A combines design with function in a medium size enclosure. Its unique enclosure offers an oversized handle for easy carrying, will accept a standard 35 mm mounting stand and includes a floor monitor position for added flexibility. Built-in rigging points and an optional mounting bracket facilitate use in permanent installations.

The DR-512A incorporates the latest in amplifier technology. A Class D amplifier that offers an impressive 1000 W peak power. Protection circuitry is provided for both amps and the components.

DR-515A

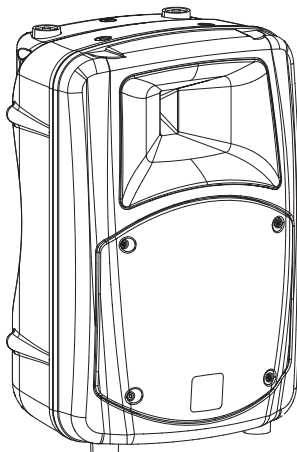

- Powered 2-way, full-range system
- 15" bass loudspeaker
- Compression driver with titanium diaphragm
- Monitor position

The DR-515A exemplifies the achievements of D.A.S. engineers in high pressure injection molding technology. The DR-515A mounts a proprietary 15" low frequency transducer and the high efficiency M-34 compression driver and CD horn assembly.

The DR-515A incorporates the latest in amplifier technology. A twin channel Class D amplifier powers the low frequency section for a total output of 1000 W peak power.

CONFIGURATIONS

DR-515A (or DR-512A)

DR-515A (or DR-512A)

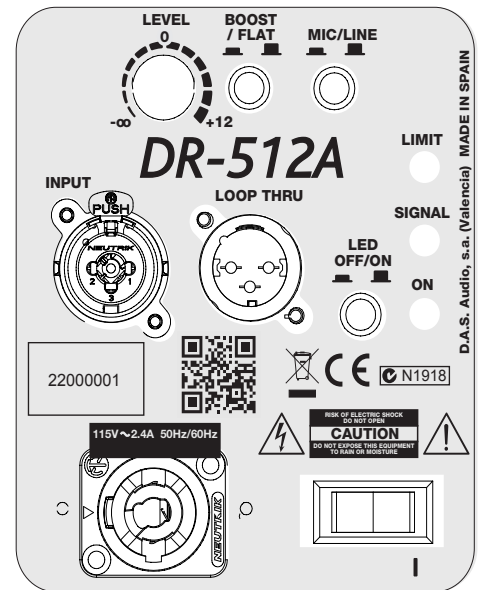
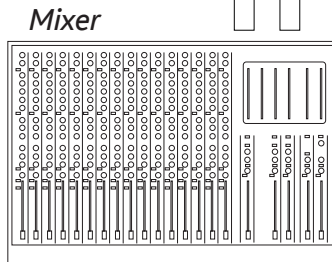
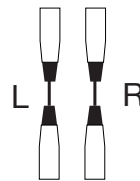
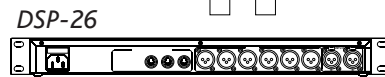
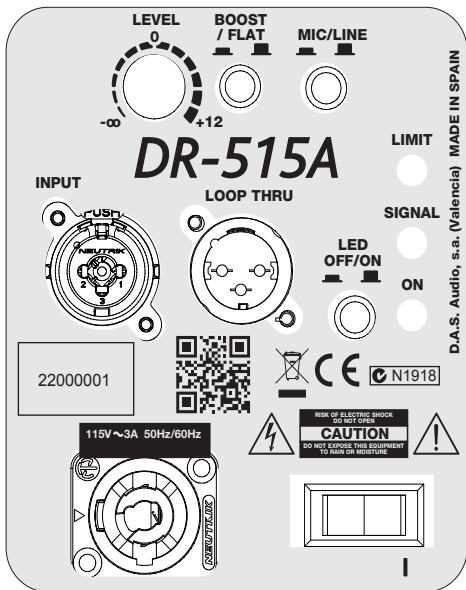
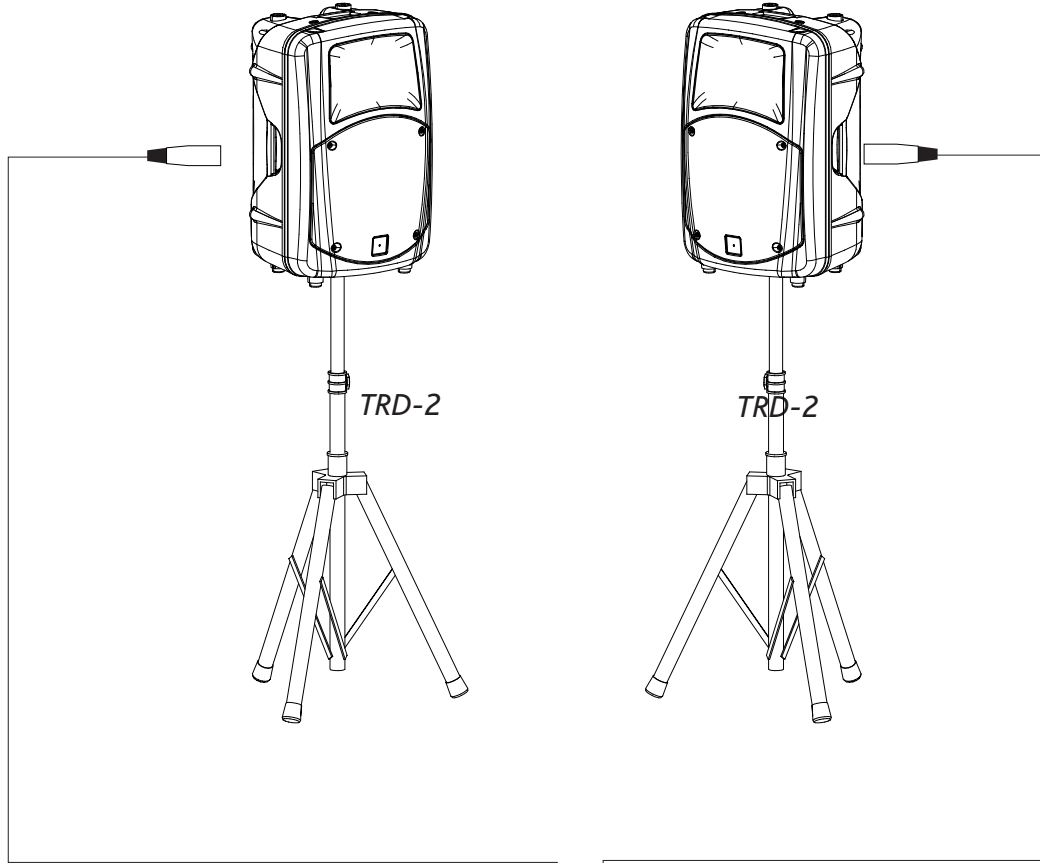

CONFIGURATIONS (cont'd)

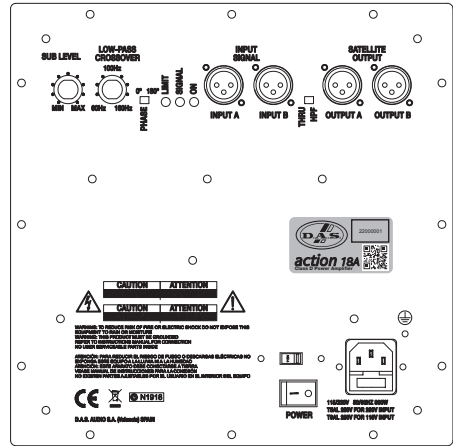
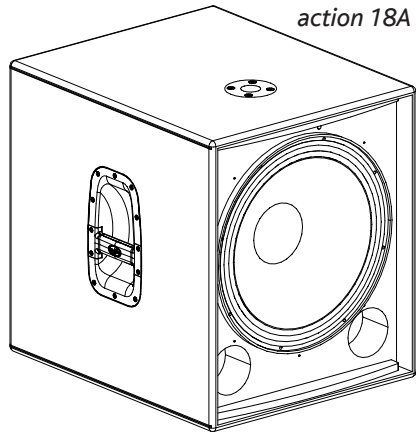

DR-512A (or DR-515A)

DR-512A (or DR-515A)

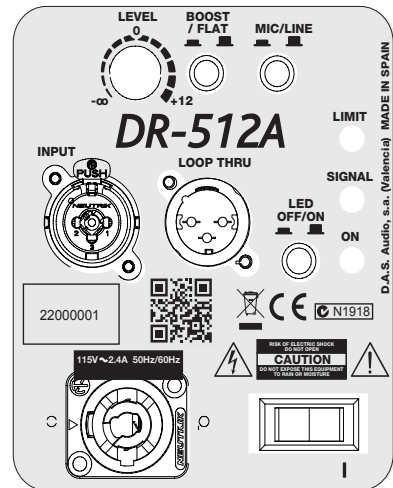
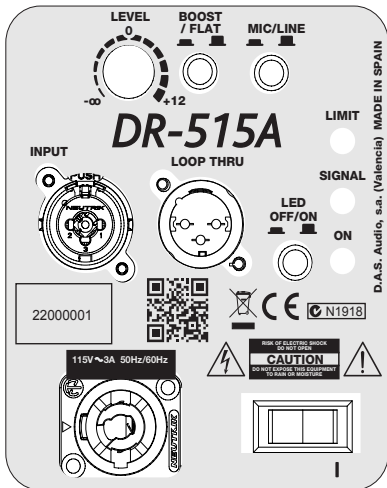
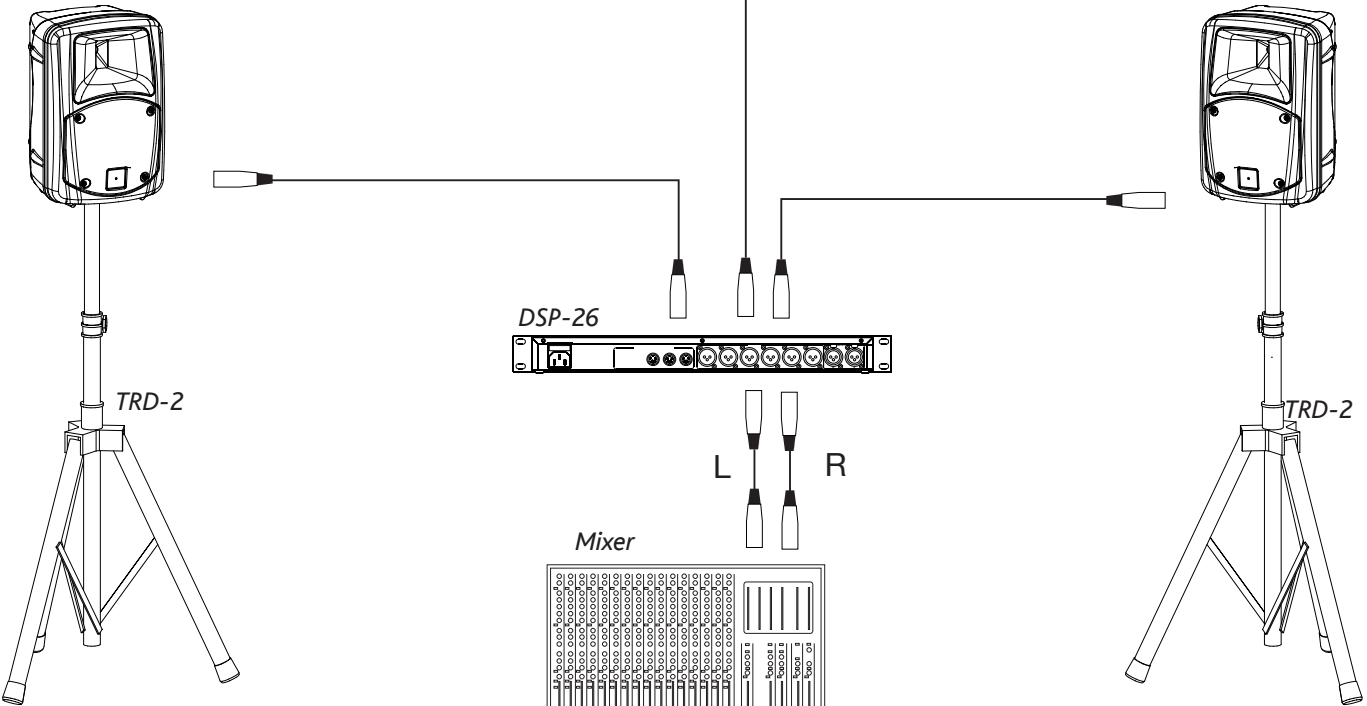

CONFIGURATIONS (cont'd)

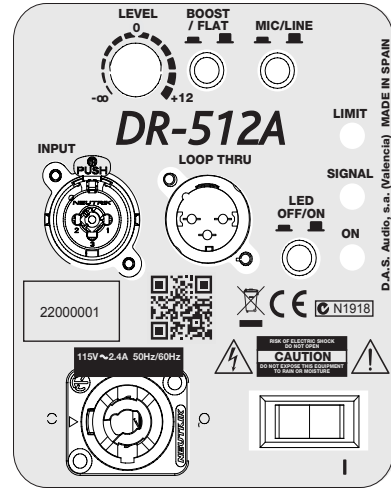
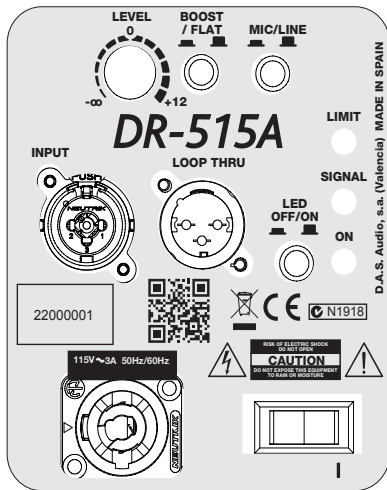

DR-512A (or DR-515A)

DR-512A (or DR-515A)

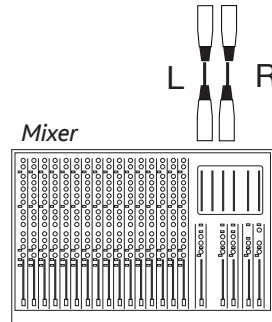
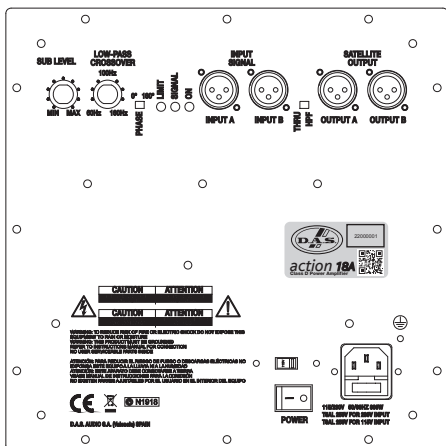
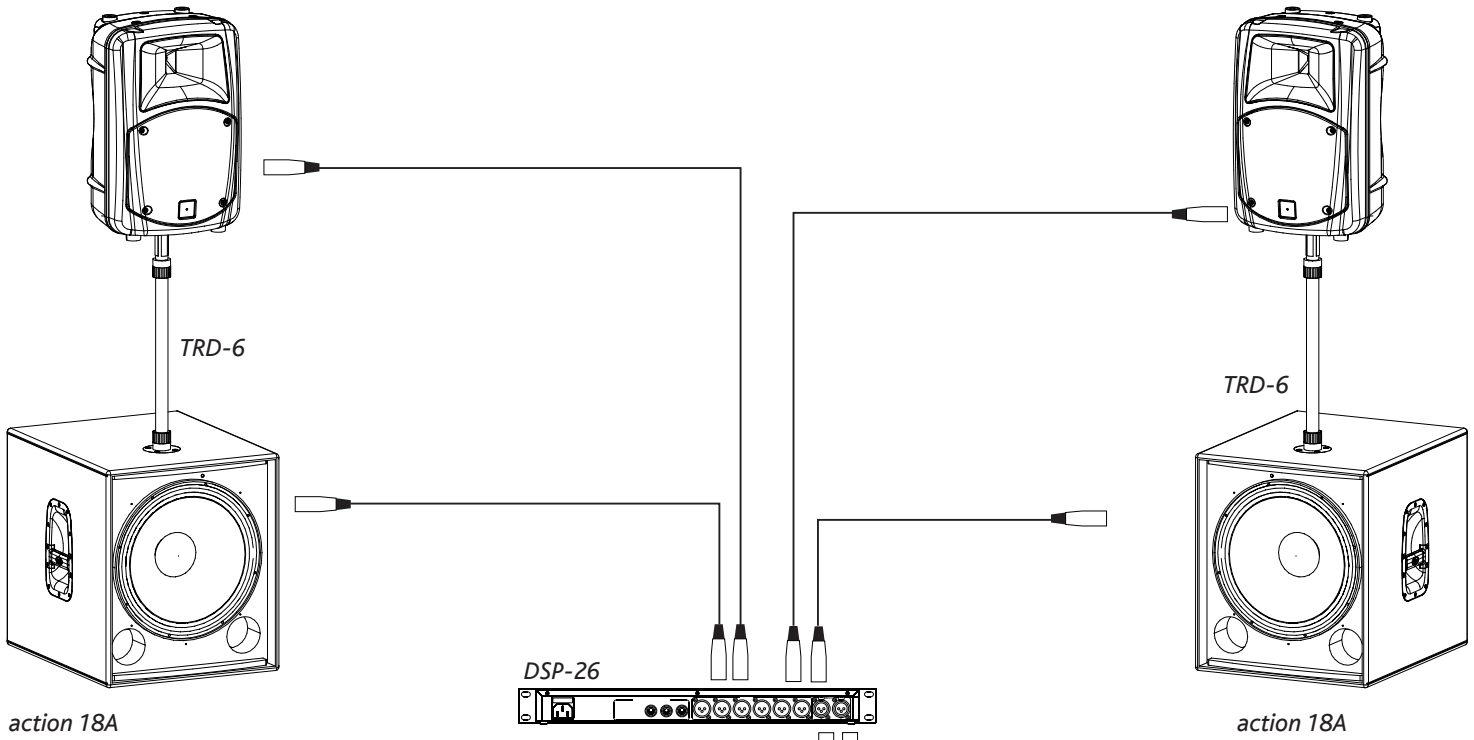

CONFIGURATIONS (cont'd)

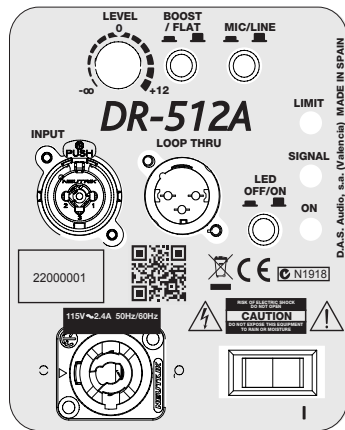
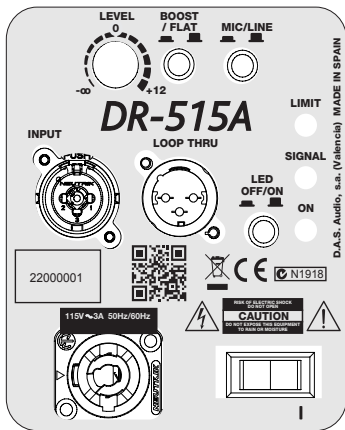

DR-515A (or DR-512A)

DR-515A (or DR-512A)

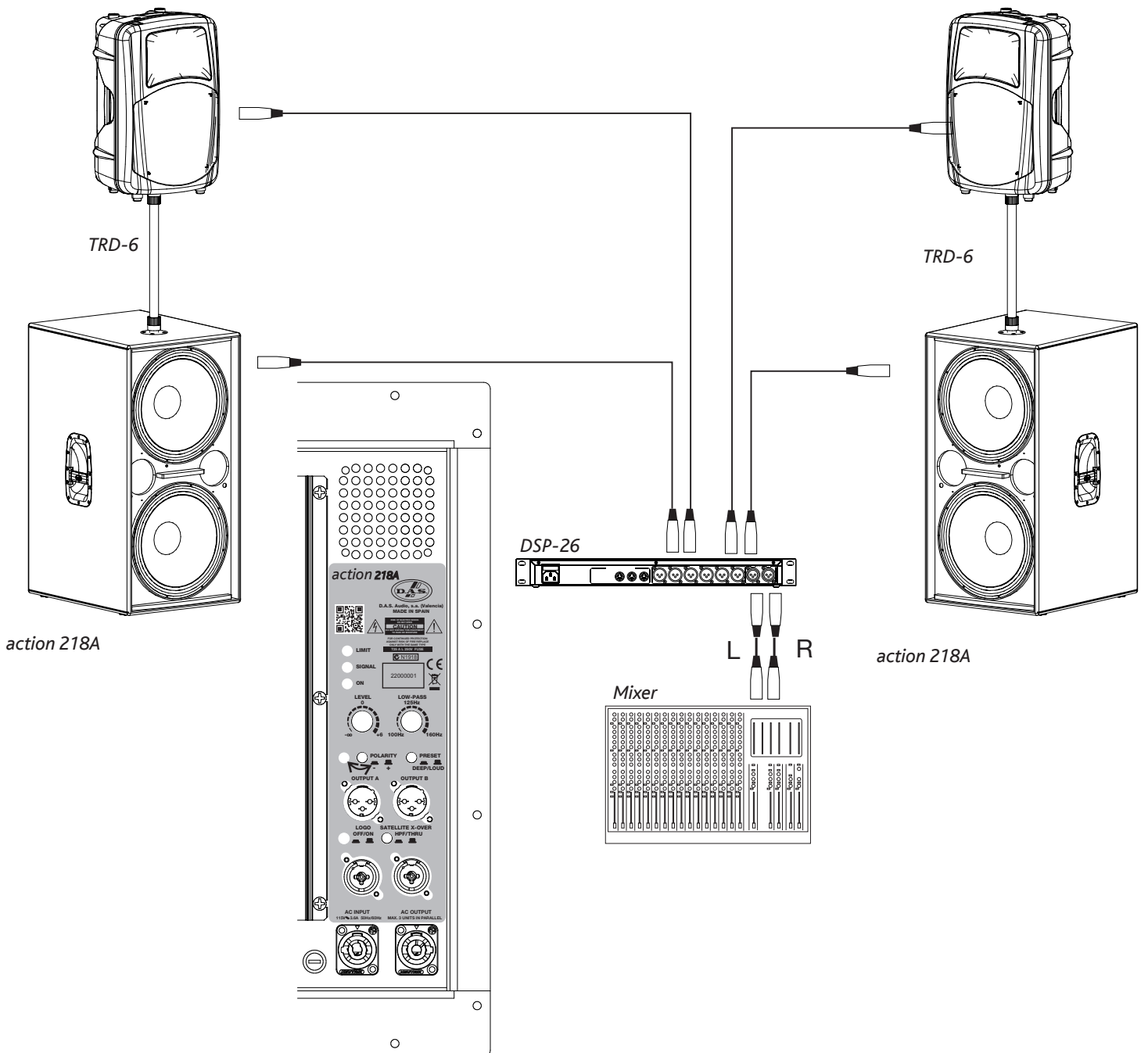

LINE DRAWINGS

ALL DIMENSIONS IN MILIMETERS

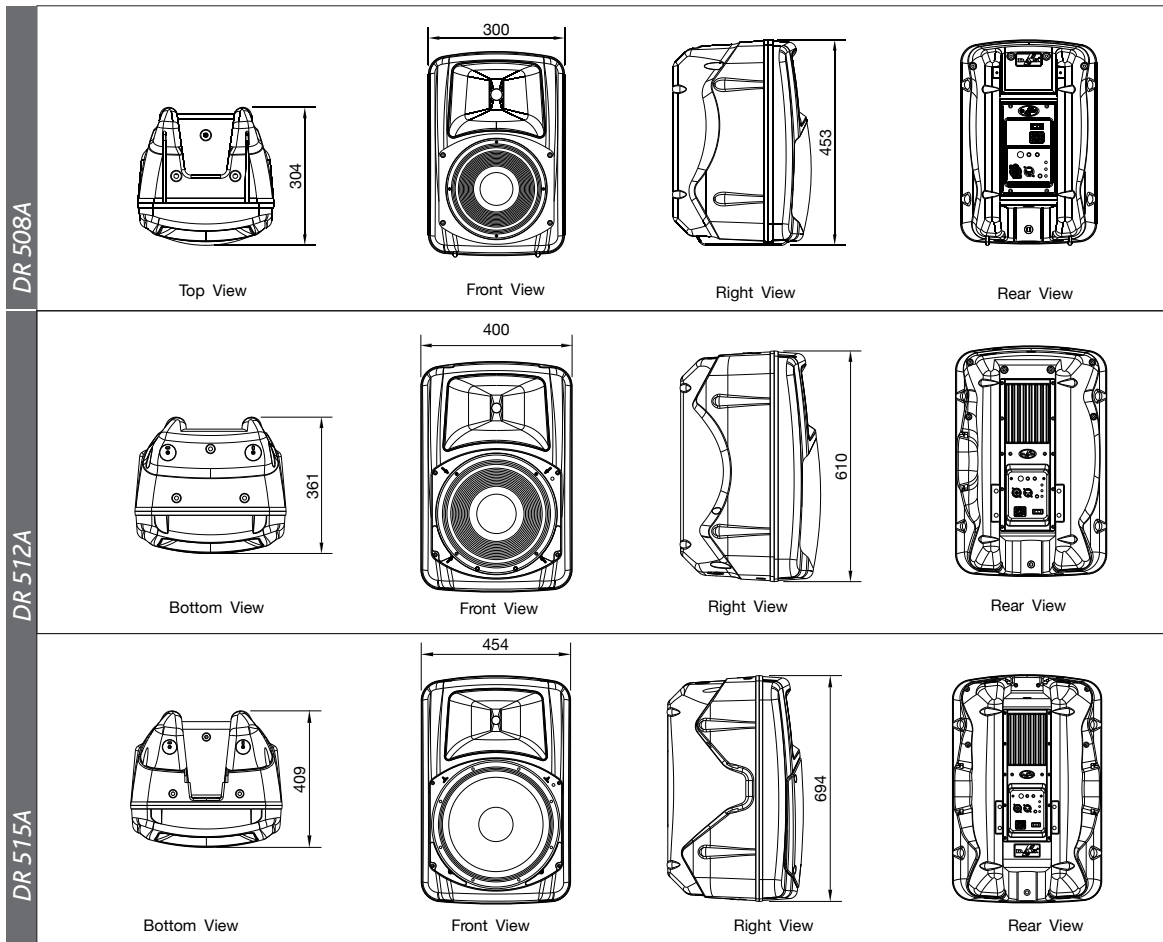

SPECIFICATIONS

Model	DR 508A	DR 512A	DR 515A
Power Amplifier	1000 W peak 500 W continuous (Class D Bi-amplified)	1000 W peak 500 W continuous (Class D Bi-amplified)	1000 W peak 500 W continuous (Class D Bi-amplified)
Input Type	Balanced Differential Line	Balanced Differential Line	Balanced Differential Line
Input Impedance	Line: 20 kohms	Line: 20 kohms	Line: 20 kohms
Sensitivity	Line: 1.95V (+8dBu)	Line: 1.95V (+8dBu)	Line: 1.95V (+8dBu)
Frequency Range (-10 dB)	60 Hz - 20 kHz	50 Hz - 20 kHz	45 Hz - 20 kHz
HF Horn Coverage Angles (-6 dB)	90° x 45°	90° x 45°	90° x 45°
Maximum Peak SPL at 1m	122 dB	131 dB	131 dB
Transducers/ Replacement Parts	LF: 8C / GM 8C HF: M-34 / GM M-34	LF: 12Mi / GM 12Mi HF: M-34 / GM M-34	LF: 15Mi / GM 15Mi HF: M-34 / GM M-34
Enclosure Material	Polypropylene	Polypropylene	Polypropylene
Color/Finish	Black	Black	Black
Connectors	INPUT: Female XLR LOOP THRU: Male XLR AC INPUT: Male IEC	INPUT: Female XLR LOOP THRU: Male XLR AC INPUT: Male IEC	INPUT: Female XLR LOOP THRU: Male XLR AC INPUT: Male IEC
AC Power Requirerments	115V, 2.4A, 50 Hz / 60 Hz 230V, 1.2A, 50 Hz / 60 Hz	115V, 2.4A, 50 Hz / 60 Hz 230V, 1.2A, 50 Hz / 60 Hz	115V, 3A, 50 Hz / 60 Hz 230V, 1.5A, 50 Hz / 60 Hz
Dimensions (H x W x D)	43 x 30 x 30 cm 18 x 12 x 12 in	62 x 40 x 37 cm 24 x 16 x 14.5 in	71 x 46 x 42 cm 28 x 18 x 16.5 in
Weight	11.4 kg (25.1 lb)	18.1 kg (39.9 lb)	20.1 kg (44.3 lb)
Accessories	ANL-1 AX-M FUN-DS-108 TRD-2 TRD-6	ANL-1 AX-115 FUN-DS-112 TRD-2 TRD-6	ANL-1 AX-115 FUN-DS-115 TRD-2 TRD-6

D.A.S. Audio S.A. continuously strives to enhance its products through investigation and development. All specifications are subject to change without prior warning.

AMPLIFIER

Description

1) INPUT :

1/4" Jack+XLR combined socket-type input signal connector
This is a balanced connector just like the LOOP THRU connector with the following pin assignments

- 1 or S =GND (ground).
- 2 or T =(+) Non inverted input.
- 3 or R =(-) Inverted input.

2) LOOP THRU :

XLR-type output signal connector for connecting several units together and sending them all the same signal.

3) LIMIT :

Red LED indicates amplifier saturation. Amplifier limiter indicator lights.

4) SIGNAL :

Green LED indicates signal presence.

5) ON :

Green LED indicates that the unit is ON.

6) LEVEL :

Potentiometer for adjusting the unit level.

7) BOOST / FLAT :

Button for switching between two types of frequency response.

8) MIC / LINE :

Button for switching between microphone and line sensitivities.

NEVER PRESS THIS BUTTON WITHOUT FIRST REDUCING THE LEVEL OF THE UNIT TO AVOID EXTREMELY HIGH SPL.

9) LOGO OFF / ON :

Press the button to illuminate the logo.

10) AC INPUT :

PowerCon NAC3FCA mains connector (inserted, rotated and locked for ON). **Only use this equipment with an appropriate mains cord.**

11) POWER :

Mains power ON/OFF switch.

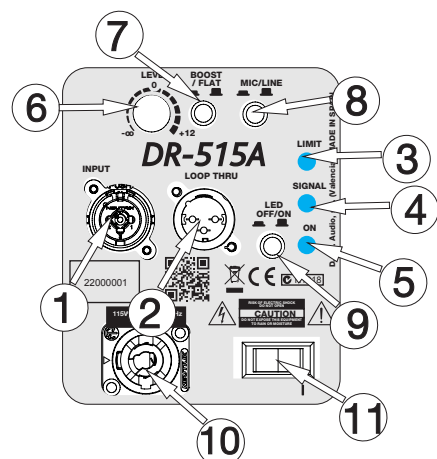
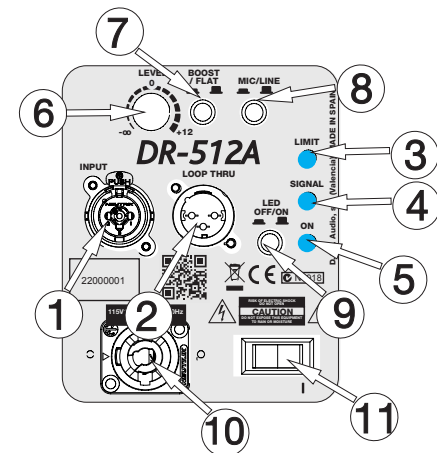
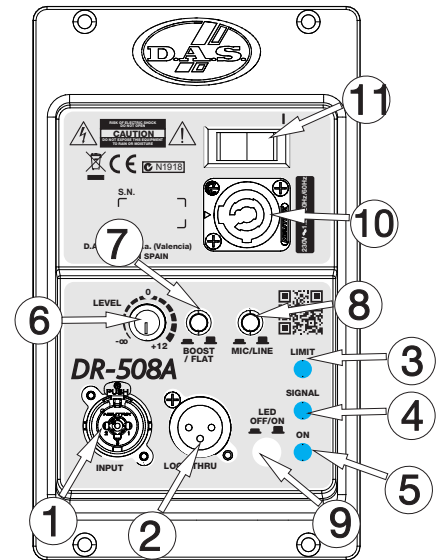

ON/OFF

A sound system should be switched on sequentially. Switch on the self-powered units last in your sound system (switch on the subwoofer before the mid-high system). Switch on the sound sources such as CD players or turntables, then the mixer, then the processors, and finally the self-powered unit. If you have several units, it is recommended that you switch them on sequentially one at a time.

Follow the inverse order when switching off, turning self-powered units off before any other element in the sound system.

Disconnect the device by removing the mains connector from the mains socket. The mains connector and mains socket must always be freely accessible and never covered or blocked in any way.

Use a power cable equipped with a Neutrik PowerCon NC3FCA connector.

IMPORTANT: Do not disconnect the unit while in use.

Ensure that the device is disconnected from the mains by observing that the ON LED is turned off. Please note that the ON LED can stay on for several seconds after the mains power has been disconnected.

Overload indicator

This device has an indicator (LIMIT LED) that lights when the signal is excessive.

The indicator should not be lit continuously. This distorts the signal (quickly fatiguing your ears) and may damage the speakers. Therefore, it is recommended that you never work with this LED on; at most it should blink only occasionally.

Equalisation

The unit does not need extreme settings of equalisation to produce quality sound. Avoid high levels of gain on the equalisers. Gain values above +3 dB on a console's EQ are not recommended.

Overheating

This equipment does not normally overheat during normal conditions of use. When overheating occurs, the unit protects itself. You should then find out why and if necessary contact an authorised dealer for technical assistance.

Normally it is enough just to let the unit cool down after you have corrected the problem so that the system functions properly again.

Low mains voltage

If mains voltage falls below the shutdown voltage for the unit, it will stop playing. When acceptable levels are regained, the unit will switch back on automatically.

Therefore the current consumed by a 115V version is double the 230V version to achieve the same acoustic power level.

<i>Pink Noise Mains 230 Vrms</i>	1/3 Potencia
<i>DR-508A</i>	1.2A
<i>DR-512A</i>	1.2A
<i>DR-515A</i>	1.5A

Troubleshooting

PROBLEM	CAUSE	SOLUTION
No sound from the unit. The SIGNAL LED does not light up.	<p>1 – The signal source is sending no signal.</p> <p>2 – Defective cable.</p> <p>3 - The amplifier has overheated.</p>	<p>1 – Check that the mixer or sound source is sending signal to the UNIT.</p> <p>2 – Check that the cable from the sound source to the UNIT is connected correctly. Replace the cable if defective.</p> <p>3 - Allow the unit to cool down for some minutes and it will function again. Check the main output level of the mixer or channel gains since the unit will have been functioning with excessive levels.</p>
Full power cannot be obtained. The LIMIT LED never lights up.	The signal source does not have a hot enough output.	If using a mixer, use the balanced output if available. Use a professional mixer with a hotter output.
Sound is distorted. The LIMIT LED is not on, or only lights up occasionally	The mixer or signal source is distorting.	Turn mixer channel gains down. Check that none of your signal sources are distorting.
Sound is distorted and very loud and LIMIT LED lights up.	The system is overloaded and has reached maximum power.	Turn down the mixer's output.
Hum or buzz when a mixer is connected to the unit.	<p>1.– The console probably has un-balanced outputs. You may be using an incorrect un-balanced to balanced cable.</p> <p>2.– The mixer and the powered speaker are not plugged into the same mains outlet.</p> <p>3.– The audio signal cable is too long or too close to an AC cable</p>	<p>1.– Read the appendix of this manual to make a correct un-balanced to balanced cable.</p> <p>2.– Connect the mixer and the unit to the same mains outlet.</p> <p>3.– Use a cable that is as short as possible and/or move the audio signal cable away from mains cables.</p>
Hum or buzz when using lighting controls in the same building.	<p>1.– The audio signal cable is too long or too close to the lighting cable.</p> <p>2.– On a sound system with three-phase AC, the lighting equipment and the UNIT are connected to the same phase.</p>	<p>1.– Move the audio signal cable away from lighting cables. Try to find out at what point the noise is leaking into the system.</p> <p>2.– Connect the sound system to a different phase than the lights. You may need the help of an electrician.</p>
The ON LED does not light up when the mains connector is connected and the unit is switched to ON.	<p>1.– Bad or loose AC connection to the UNIT or the mains outlet.</p> <p>2 – Faulty AC cable.</p>	<p>1.– Check your connections.</p> <p>2.– Check the cables, connectors and AC power with a suitable mains tester.</p>

APPENDIX: Line connections: unbalanced and balanced

There are two basic ways to transport an audio signal with microphone or line level:

Unbalanced line: Utilising a two conductor cable, it transports the signal as the voltage between them. Electromagnetic interference can get added to the signal as undesired noise. Connectors that carry unbalanced signals have two pins, such as RCA (Phono) and 1/4" (6.35mm, often referred to as jack) mono. 3 pin connector such as XLR (Cannon) may also carry unbalanced signals if one of the pins is unused.

Balanced line: Utilising a three conductor cable, one of them acts as a shield against electromagnetic noise and is the ground conductor. The other two have the same voltage with respect to the ground conductor but with opposite signs. The noise that cannot be rejected by the shield affects both signal conductors in the same way. At the device's input the two signals get summed with opposite sign, so that noise is cancelled out while the programme signal doubles in level. Most professional audio devices use balanced inputs and outputs. Connectors that can carry balanced signal have three pins, such as XLR (Cannon) and 1/4" (6.35mm) stereo.

The graphs that follow show the recommended connection with different types of connectors to balanced processor or amplifier inputs. The connectors on the left-hand side come from a signal source, and the ones on the right hand side go to the inputs of the processor or amplifier. Note that on the unbalanced connectors on the left-hand side, two terminals are joined inside the connector. If hum occurs with unbalanced to balanced connections, try disconnecting the sleeve (ground) on the input connector. Note that the illustrations show what should be connected to what, but that pin locations on an actual XLR connector are different. Also, pin 2 hot is assumed on XLR connectors.

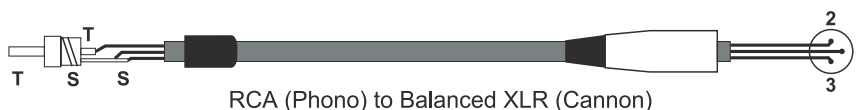
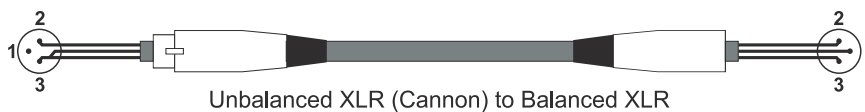

www.dasaudio.com



D.A.S. AUDIO, S.A.
C/. Islas Baleares, 24
46988 Fuente del Jarro
Valencia, SPAIN
Tel. 96 134 0525
Tel. Intl. +34 96 134 0860
Fax 96 134 0607
Fax Intl. +34 96 134 0607

D.A.S. AUDIO OF AMERICA, INC.
Sunset Palmetto Park
6816 NW 77th Court.
Miami, FL. 33166 - U.S.A.
TOLL FREE: 1-888DAS4USA
Tel. +1 305 436 0521
Fax +1 305 436 0528

D.A.S. AUDIO ASIA PTE. LTD.
25 Kaki Bukit Crescent #01-00/02-00
Kaki Bukit Techpark 1
Singapore 416256
Tel. +65 6742 0151
Fax +65 6742 0157