

REDNET A8R

ANALOGUE I/O

REDNET A16R

ANALOGUE I/O

User Guide

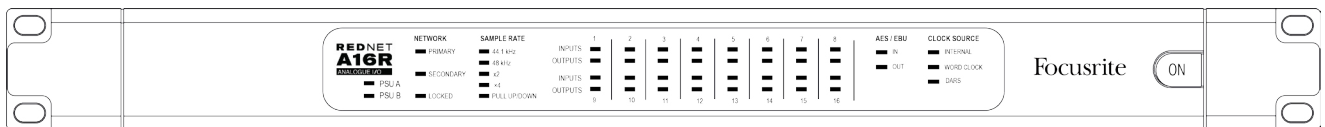
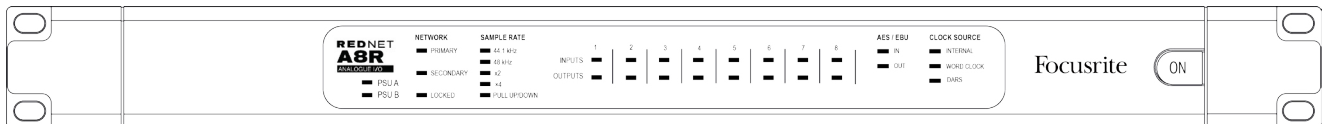

Focusrite®

CONTENTS

About this User Guide	3
Box Contents	3
INTRODUCTION	4
INSTALLATION GUIDE	5
RedNet A8R/A16R Connections and Features	5
Front Panels	5
Rear Panels	7
Power Connection	9
IEC Power Cord Retaining Clip	9
Physical Characteristics	10
Power Requirements	10
REDNET A8R/A16R OPERATION	11
First Use and Firmware Updates	11
Digital Clocking	11
Pull Up and Pull Down Operation	11
Sample Rate Converters	11
OTHER REDNET SYSTEM COMPONENTS	12
USING REDNET CONTROL	12
Signal Metering	12
ID (Identification)	13
Tools Menu	13
APPENDIX	14
Connector Pinouts	14
Ethernet Connector	14
DB-25 (AES59) Connector	14
XLR Connectors	14
PERFORMANCE AND SPECIFICATIONS	15
Focusrite RedNet Warranty and Service	18
Registering Your Product	18
Customer Support and Unit Servicing	18
Troubleshooting	18

About this User Guide

This user guide applies to both the RedNet A8R and RedNet A16R analogue interfaces. It provides information about installing and using each unit and how either can be connected into your system.

All information relating to the RedNet A8R is also applicable to the RedNet A16R. Where channel quantities or information differs between the two units, the detail for the A16R unit will be appended in square brackets, eg., “8 [16] channels”.

A RedNet System User Guide is also available from the RedNet product pages of the Focusrite website. The guide provides a detailed explanation of the RedNet system concept, that will help you achieve a thorough understanding of its capabilities. We recommend that all users, including those already experienced in digital audio networking, take the time to read through the System User Guide so that they are fully aware of all the possibilities that RedNet and its software have to offer.

Box Contents

- RedNet A8R [A16R] unit
- 2 x IEC AC mains cables
- 2 x IEC mains cable retaining clips (*See instructions on page 9*)
- Safety information cut sheet
- RedNet Getting Started Guide
- Product registration card, which provides links to:
 - RedNet Control
 - RedNet PCIe drivers (included with RedNet Control download)
 - Audinate Dante Controller (installed with RedNet Control)
 - Dante Virtual Soundcard (DVS) Token and download instructions

Dante™ and Audinate™ are registered trademarks of Audinate Pty Ltd.

INTRODUCTION

Thank you for purchasing the Focusrite RedNet A8R/A16R.

RedNet A8R

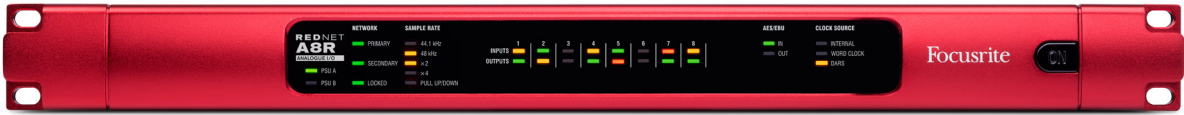

RedNet A16R



RedNet A8R/A16R is a 1U 19in rack-mount interface featuring 8 [16] channels of A-D/D-A plus one AES/EBU channel-pair for the Dante audio-over-IP network. Specifically tailored for the road, live-sound and broadcast environments, each unit features network and power redundancy, rugged construction with latching connectors, remote control and remote monitoring.

Dual Ethernet connectors (primary and secondary) on the rear-panel allow maximum network reliability with seamless switchover to a standby network in the unlikely event of a network failure. These ports may also be used to daisy-chain additional units when operating in Switched mode.

Redundant power supplies (PSU A and B) with separate input sockets on the rear panel allow one supply to be connected to an uninterruptible source. Each PSU's status can be monitored remotely over the network or from the front panel.

RedNet A8R/A16R has a Sample Rate Converter (SRC) on the AES/EBU input pair allowing instant operation with any AES/EBU source irrespective of the sample rate or clocking of the Dante network.

Audio interface is provided by two [four] standard 8-way (AES59) DB-25 connections. In addition, channels 9-10 [17-18*] act as the AES/EBU channels.

*[*When operating at quad sample rates, channels 17-18 are no longer available, meaning that the user can select either: 1-16 analogue -or- 1-14 analogue and 15-16 AES/EBU.]*

Word Clock I/O on BNC connectors allows synchronisation of the Dante network to house clock, or syncing external equipment to the Dante network. DARS reference can also be accepted via the XLR input connector.

The RedNet A8R/A16R front panel contains a set of LEDs to confirm PSU status, network status, sample rate, clock sources and signal presence on AES/EBU and signal metering on Analogue I/O.

INSTALLATION GUIDE

RedNet A8R/A16R Connections and Features

Front Panels

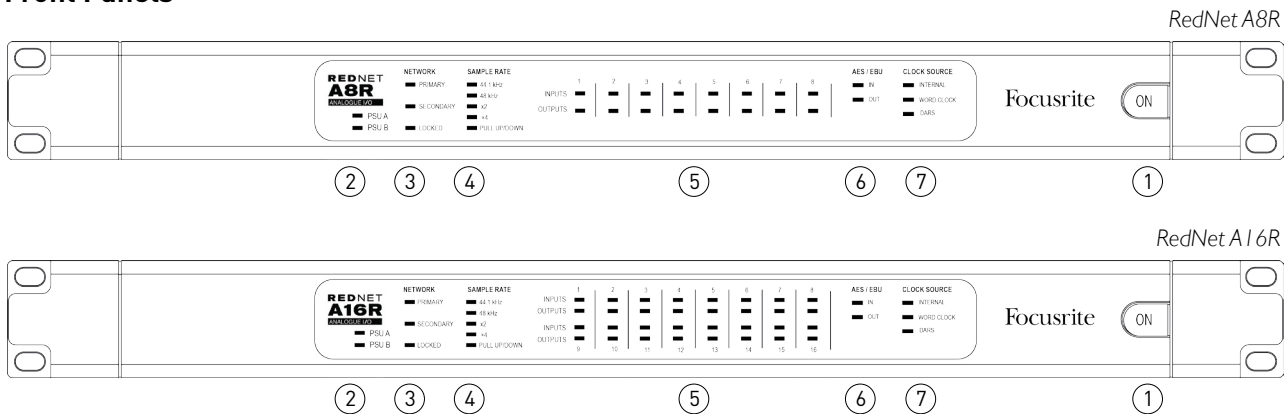

1. AC Power Switch

2. Power Indicators:

- **PSU A** – Illuminates when an AC input is applied and all DC outputs are present.
- **PSU B** – Illuminates when an AC input is applied and all DC outputs are present.

When both supplies are functioning and have AC inputs PSU A will be the default supply.

3. RedNet Network Status Indicators:

- **PRIMARY** – Illuminates when the device is connected to an active Ethernet network. Also illuminates to indicate network activity when operating in Switched mode on either port.
- **SECONDARY** – Illuminates when the device is connected to an active Ethernet network. Not used when operating in Switched mode.
- **LOCKED** – Illuminates when a valid sync signal is received from the network, or when the RedNet A8R/A16R unit is the Network Master. Flashes if external clock is selected but not connected.

4. RedNet Sample Rate Indicators

Five orange indicators: **44.1 kHz**, **48 kHz**, **x2** (multiple of 44.1 or 48), **x4** (multiple of 44.1 or 48) and sample rate **PULL UP/DOWN**. These Indicators illuminate individually or in combination to indicate the sample rate being used. For example, for a 96kHz Pull Up/Down setting, the 48kHz, x2 and Pull Up/Down indicators will illuminate.

5. Signal Level Indicators:

- **INPUTS** – Tri-colour LEDs indicate audio signal levels at the inputs to the network:
 - Green: Signal present (illuminates at -42 dBFS)
 - Orange: -6 dBFS
 - Red: 0 dBFS

Continued...

Front Panels ... Continued

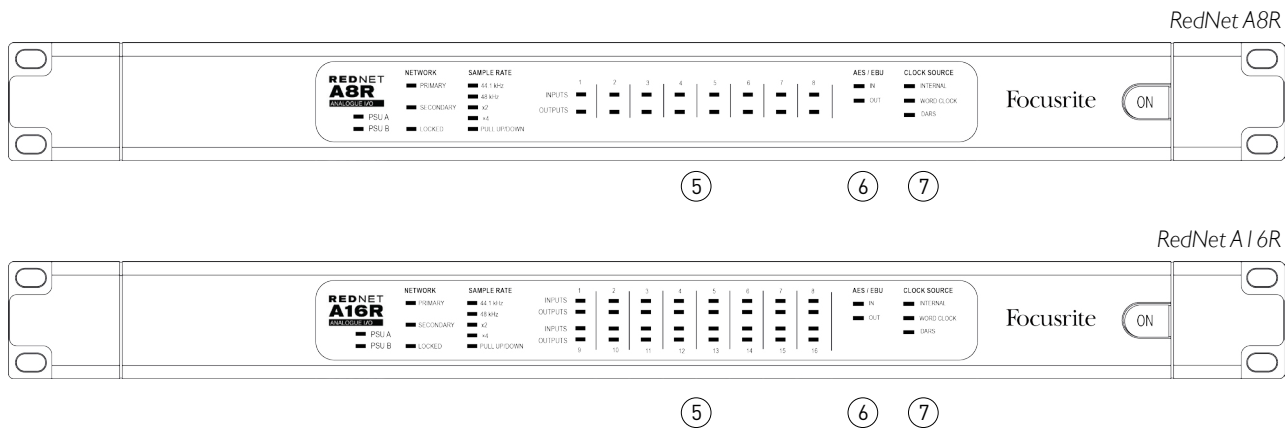

5. Signal Level Indicators:

- **OUTPUTS** – Tri-colour LEDs indicate audio signal levels at the outputs from the network:
 Green: Signal present (illuminates at -42 dBFS)
 Orange: -6 dBFS
 Red: 0 dBFS

[When a RedNet A16R unit is operating at quad sample rates, the indication for LEDs 15 and 16 will depend on the signal mode selected.]

Mode	LED 15	LED 16
Analogue	Analogue ch 15	Analogue ch 16
AES/EBU	AES/EBU Left	AES/EBU Right

6. AES/EBU Signal Presence Indicators

Green LEDs indicate if an AES/EBU signal is present **IN** to the network, and **OUT** from the network; each illuminates at -126 dBFS.

[When a RedNet A16R unit is operating at quad sample rates, the IN and OUT LEDs don't illuminate if Analogue mode has been selected.]

Mode	'IN' LED	'OUT' LED
Analogue	Off	Off
AES/EBU	Analogue ch 15/16	Analogue ch 15/16

7. RedNet Clock Source Indicators

Three orange indicators: **Internal**, **Word Clock** (BNC input) and **DARS** (XLR input). Whichever is lit identifies the clock reference being used. When an incoming clock source is invalid, the 'Locked' indicator will flash to indicate that the unit has reverted to using its internal clock.

Rear Panels

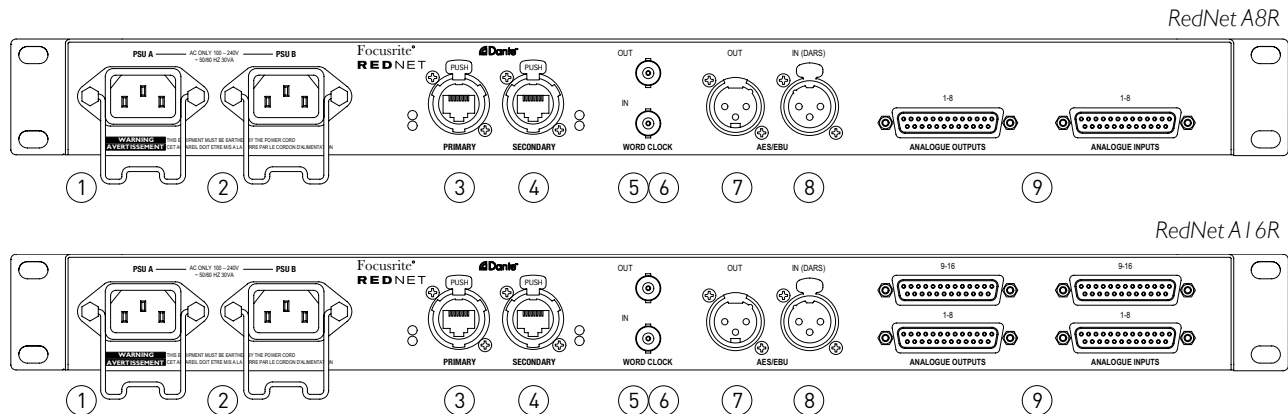

1. IEC Mains Inlet A

Standard IEC receptacle for connection of AC mains. RedNet A8R/A16Rs feature 'Universal' PSUs, enabling them to operate on any supply voltage of between 100 V and 240 V.

Note that initial use requires fitment of the plug retaining clips – see page 9.

2. IEC Mains Inlet B

Input connector for backup mains power source. Power supply B remains on standby but will seamlessly take over if PSU A develops a fault or loses its mains input supply.

If an uninterruptable supply (UPS) is available, it is recommended that this is applied to input B.

3. Primary Network Port

Latching etherCON connector for the Dante network. Use standard Cat 5e or Cat 6 network cable to connect to a local Ethernet switch to connect the RedNet A8R/A16R to a Dante network. Adjacent to each network socket are LEDs which illuminate to indicate a valid network connection plus network activity. *See page 14 for connector details.*

4. Secondary Network Port

Secondary Dante network connection where two independent Ethernet links are being used (Redundant mode), or an additional port on an integral network switch on the primary network (Switched mode).

5. Word Clock Out

Provides an output of the chosen system clock reference (can be switched between base rate or network rate).

6. Word Clock In

Allows synchronisation of the Dante network to house word clock.

Refer to the Appendix on page 14 for connector pinouts.

Rear Panels ... Continued

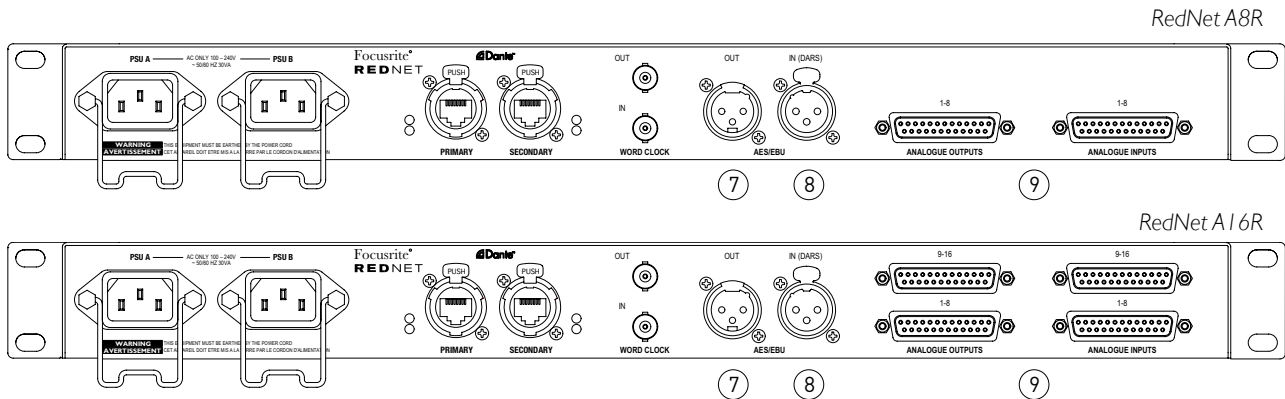

7. AES/EBU Out

Permanent AES/EBU output of audio channel pair 9-10 [17-18*].

*[*When a RedNet A16R unit is operating at quad sample rates, AES/EBU Out becomes duplicate of network channels 15-16. The output is available when operating in either AES/EBU or Analogue mode.]*

8. AES/EBU In

AES/EBU source for channels 9-10 [17-18*]. May also be used as a clock source when fed with either AES/EBU or DARS (Digital Audio Reference Signal – AES/EBU distributed clock as per AES11).

*[*When a RedNet A16R unit is operating at quad sample rates, AES/EBU In replaces Analogue channels 15-16 when operating in AES/EBU mode.]*

9. DB-25 Connectors

Analogue inputs and outputs; eight channels per connector. Wired to the AES59 8-way standard (also known as the Tascam standard).

Refer to the Appendix on page 14 for connector pinouts.

Power Connection

IEC Power Cord Retaining Clip

RedNet A8R/A16R is supplied with IEC power cord retaining clips. These prevent accidental disconnection of a power cord during use. When the unit is first installed, the retaining clips will need to be attached to the power input sockets on the rear panel.

Insert each clip by squeezing together the legs as shown in the first image below, aligning the pins with the through-holes on the IEC fixing posts one at a time, and then releasing.

Ensure that the orientation of each clip is as shown in the other images below or the effectiveness will be compromised.

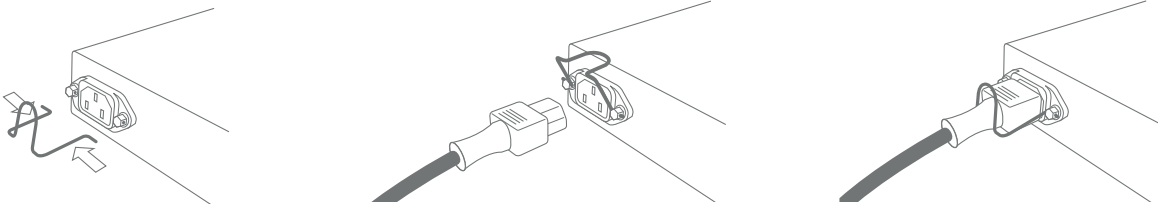

Physical Characteristics

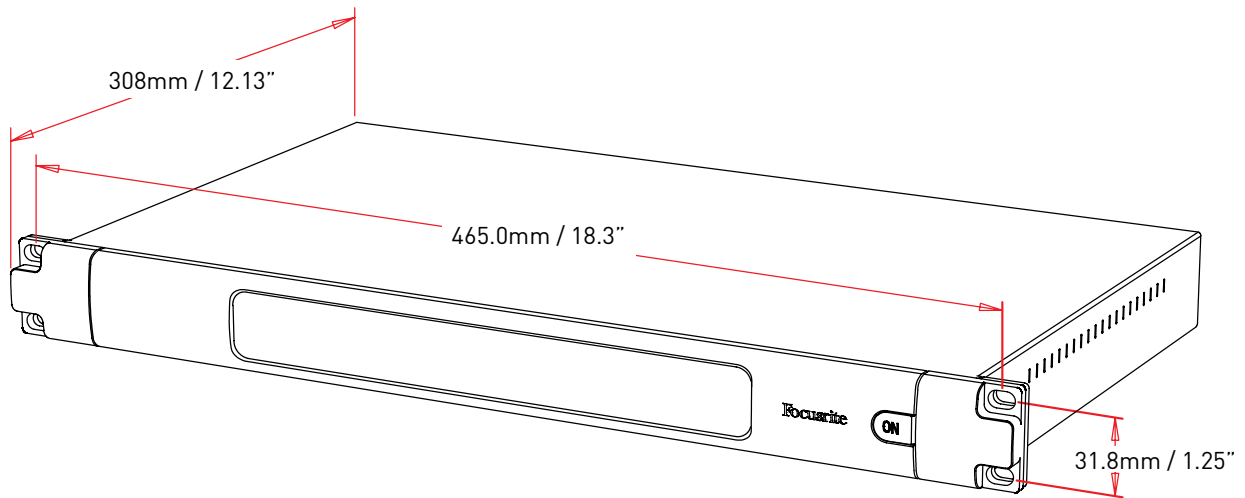

RedNet A8R/A16R dimensions are illustrated in the diagram above.

RedNet A8R/A16R requires 1U of vertical rack space and at least 350 mm of rack depth, to allow for cables. RedNet A8R/A16R weighs 4.52 [4.78] kg and for installations in a fixed environment (eg., a studio), the front-panel mounting screws will provide adequate support. If the units are to be used in a mobile situation (eg., flight-cased for touring, etc.), it is recommended that side support rails or shelves should be used within the rack.

Cooling is by fan assistance from side to side. The fan used is low-speed and low-noise to allow for an ambient operating temperature of 50 degrees Celcius.

[RedNet A16R has two fans, at higher ambient operating temperatures the fans will increase in speed to allow for an ambient operating temperature of 50 degrees Celcius.]

Ventilation is via slots in the enclosure at both sides. Do not mount RedNet A8R/A16R immediately above any other equipment which generates significant heat, for example, a power amplifier. Also, ensure that when mounted in a rack, the side vents are not obstructed.

Power Requirements

RedNet A8R/A16R is mains-powered. It incorporates 'Universal' power supplies which can operate on any AC mains voltage from 100 V to 240 V. The AC connections are made via a standard 3-pin IEC connectors on the rear panel.

When PSU A & PSU B are both connected, PSU A becomes the default supply and therefore draws more current than B. If a backup mains supply is provided from an uninterruptable source, it is recommended that this is connected to input B.

Mating IEC cables are supplied with the unit; these should be terminated with mains plugs of the correct type for your country.

The AC power consumption of the RedNet A8R/A16R is 24 [41] W.

Please note that there are no fuses in RedNet A8R/A16R, or other user-replaceable components of any type. Please refer all servicing issues to the Customer Support Team (see "Customer Support and Unit Servicing" on page 18).

REDNET A8R/A16R OPERATION

First Use and Firmware Updates

Your RedNet A8R/A16R may require a firmware update* when it is first installed and switched on. Firmware updates are initiated and handled automatically by the RedNet Control application.

**It is important that the firmware update procedure is not interrupted – either by switching off power to the RedNet A8R/A16R unit or the computer on which RedNet Control is running, or by disconnecting either from the network.*

From time to time Focusrite will release RedNet firmware updates within new versions of RedNet Control. We recommend keeping all RedNet units up to date with the latest firmware version supplied with each new version of RedNet Control.

Digital Clocking

Each RedNet A8R/A16R will automatically lock to a valid Network Master via its Dante connection. Alternatively, if a Network Master is not present, then the unit can be chosen as the Network Master by the user.

Pull Up and Pull Down Operation

RedNet A8R/A16R is able to operate at a specified pull up or pull down percentage as selected in the Dante Controller application.

Sample Rate Converters

SRC will need to be switched on if the AES/EBU source is not using the current system clock as a reference signal.

Note that engaging the sample rate converter will increase the overall latency of the device.

OTHER REDNET SYSTEM COMPONENTS





The RedNet hardware range includes various types of I/O interface and the PCIe/ PCIeR digital audio interface cards which are installed in the system's host computer or in a chassis. All the I/O units can be considered as "Break-Out" (and/or "Break-In") boxes to/from the network, and all are built in mains-powered, 19" rackmount housings, unless otherwise stated. There are also three software items, RedNet Control (see below), Dante Controller and Dante Virtual Soundcard.

USING REDNET CONTROL

RedNet Control will reflect the status of the RedNet units present in the system, presenting an image representing each hardware unit.



The illustration above shows a RedNet A8R with signals present on all input and output channels. The unit has a single PSU input, single network input and a locked network connection.

-  PSUs A & B – Each illuminates if PSU has power input and all DC outputs are present
-  Networks – Each illuminates if a valid connection is present.
-  Locked – Unit is successfully locked to the network (changes to the red cross if not locked).
-  Network Master – Illuminated, indicating that unit is network master.
-  External Clock – Green: Illuminates when external clock is selected and locked.
Amber: Illuminates when external clock is selected but not locked.
Red: Illuminates when external clock is selected but not connected.

Signal Metering

Each input and output channel has a three-segment meter. The different states illuminate at the below values:

- Green: -42 dBFS
- Amber: -6 dBFS
- Red: 0 dBFS

-SRC- : Indicates sample rate converters are switched on for the AES/EBU channel pair.

ID (Identification)

Clicking on the ID icon  will identify the physical device being controlled by flashing its front panel LEDs.

Tools Menu

Clicking on the Tools icon  will gain access to the following system settings:

Line Level Setup – Sets the analogue line output level at 0 dBFS:

- +18dBu
- +24dBu *Factory default setting*

[Inputs 15 & 16 from XLR] – Tick option (*RedNet AI 6R units only*). When selected, analogue channels 15 and 16 are replaced by the AES/EBU channel pair.

Note: Option is only functional when unit is operating at quad sampling rate.

Preferred Master – On/Off state.

RedNet Clock Source – Only one of the following can be selected at any time:

- Internal (RedNet is network master but running from internal clock)
- Work Clock Input - (BNC Input)
- XLR Input (DARS)

Note: When selecting any clock source, RedNet A8R/AI 6R will become a preferred master.

Word Clock Input Termination – Tick option On/Off. (Terminates word clock input BNC with 75Ω.)

Word Clock Output – One can be selected at any time.

- Network
- Network (Base Rate)

AES/EBU Input SRC – On/Off state. Applicable to channels 9 & 10 [17 & 18]. Enables Sample Rate Converters

APPENDIX

Connector Pinouts

Ethernet Connector

Connector type: RJ-45 receptacle
 Applies to: Ethernet (Dante)

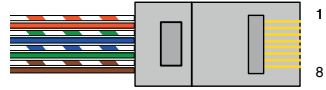

Pin	Cat 6 Core
1	White + Orange
2	Orange
3	White + Green
4	Blue
5	White + Blue
6	Green
7	White + Brown
8	Brown

DB-25 (AES59) Connector

Connector type: DB-25 receptacle
 Applies to: Analogue I/O

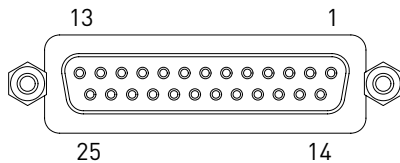

Screw binding-posts use the standard UNC 4/40 thread

Pin	Signal
1	Channel 8 +
14	Channel 8 -
2	Ground
15	Channel 7 +
3	Channel 7 -
16	Ground
4	Channel 6 +
17	Channel 6 -
5	Ground
18	Channel 5 +
6	Channel 5 -
19	Ground
7	Channel 4 +
20	Channel 4 -
8	Ground
21	Channel 3 +
9	Channel 3 -
22	Ground
10	Channel 2 +
23	Channel 2 -
11	Ground
24	Channel 1 +
12	Channel 1 -
25	Ground
13	n/c

XLR Connectors

Connector type: XLR-3 receptacle
 Applies to: AES/EBU-DARS Input

Connector type: XLR-3 plug
 Applies to: AES/EBU Output

Pin	Signal
1	Screen
2	Hot (+ve)
3	Cold (-ve)

PERFORMANCE AND SPECIFICATIONS

Line Inputs	
All measurements taken at +24dBu reference level, $R_s = 50\Omega$	
0 dBFS Reference Level	+18 or +24dBu (switchable)
Frequency Response	20Hz – 20kHz ± 0.1 dB
THD + N	<-100dB (0.001%) unweighted, 20Hz – 20kHz; -1dBFS input
EIN	-96dBu 'A'-Weighted (typical)
Signal-to-Noise Ratio	120dB 'A'-Weighted (typical)
Converter Dynamic Range	120dB 'A'-Weighted (typical), 10Hz – 20kHz

Line Outputs	
All measurements taken at +24dBu reference level, $R_L = 100k\Omega$	
0 dBFS Reference Level	+18 or +24dBu (switchable)
Frequency Response	20Hz – 20kHz ± 0.1 dB
THD + N	<-100dB (0.001%) unweighted, 20Hz – 20kHz; +23dBu input
Noise in Presence of Signal	-94dBu 'A'-Weighted (typical)
Dynamic Range	118 dB 'A'-Weighted (typical)
Convertor Dynamic Range	120dB 'A'-Weighted (typical), 10Hz – 20kHz

Crosstalk	
Input to Output or Input	<-100dB unweighted, 20Hz – 20kHz; +23dBu input
Output to Input or Output	<-100dB unweighted, 20Hz – 20kHz; -1dBFS input

Input Sample Rate Converters	
Sample Rate Range	32kHz to 216kHz
Gain Error	-0.3dB
Dynamic Range	> 138dB
THD+N	<-130dB (0.00003%)
Latency	11 to 45 samples (network and sample rate dependent)

Digital Performance	
Supported Sample Rates	44.1 / 48 / 88.2 / 96 / 176.4 / 192 kHz (-4% / -0.1% / +0.1% / +4.167%) at 24 bit
Clock Sources	Internal or from Dante Network Master.
External Word Clock Range	Nominal sample rate $\pm 7.5\%$

Rear Panel Connectivity	
Analogue Audio	
Channel Count	8 [16] channels input and output
Input and Output	2 [4] x DB-25 female connectors (AES59 / Tascam Analogue)
AES/EBU	
Channel Count	2 channels input and output
Alternate Input (optional DARS)	1 x XLR-3 female [Switchable with analogue input channels 15 and 16 at quad rates]
Alternate Output	1 x XLR-3 male [Duplicate of analogue output channels 15 and 16 at quad rates]
Word Clock	
Input	1 x BNC 75 Ω port (switchable termination)
Output	1 x BNC 75 Ω port
PSU & Network	
PSU	2 x IEC Inputs with retaining clips
Network	2 x etherCON NE8FBH, also compatible with standard RJ45 connectors (Accommodates rugged etherCON NE8MC*. Does not intermate with Cat 6 cable connector NE8MC6-MO and NKE65* cable)

Front Panel Indicators	
Primary PSU (A)	Green LED. Illuminates when an AC input is applied and all DC outputs are present.
Primary PSU (B)	Green LED. Illuminates when an AC input is applied and all DC outputs are present.
Primary Network	Green LED. Indicates that a network connection is present on primary port when in redundant mode. When in Switched mode, a valid network connection at either Primary or Secondary network port will cause this LED to illuminate.
Secondary Network	Green LED. Indicates that a network connection is present on secondary port when in redundant mode. Not used in switched mode.
Network Locked	Green LED. When unit is network slave, shows valid network lock. When unit is network master, shows lock to internal clock.
Sample Rate	Orange LED for each: 44.1 kHz, 48 kHz, x2, x4.
Pull Up/Down	Orange LED. Indicates that the unit is set to operate on a Dante pull up/down domain.
Channel Signal Level	8 [16] Input and 8 [16] Output tri-state signal level LEDs: Green LED (> -42dB), Orange LED (> -6dB) and Red (> 0dB)
AES/EBU	2 I/O signal indicator LEDs (one input, one output). Green LED illuminates >-127dBFS
Clock Source	Orange LED for each: Internal, Word Clock and DARS

Network Modes	
Redundant	Allows unit to connect to two independent networks.
Switched	Connects both ports to integrated network switch allowing daisy-chaining of devices.

Dimensions	
Height	44.5mm / 1.75" (1RU)
Width	482.09mm/ 18.98"
Depth	352.12mm/ 12.80"

Weight	
Weight	4.52 [4.78] kg

Power	
PSUs	2 x Internal, 100-240V, 50/60Hz, consumption 24 [41] W

Focusrite RedNet Warranty and Service

All Focusrite products are built to the highest standards and should provide reliable performance for many years, subject to reasonable care, use, transportation and storage.

Very many of the products returned under warranty are found not to exhibit any fault at all. To avoid unnecessary inconvenience to you in terms of returning the product please contact Focusrite support.

In the event of a Manufacturing Defect becoming evident in a product within 12 months from the date of the original purchase Focusrite will ensure that the product is repaired or replaced free of charge.

A Manufacturing Defect is defined as a defect in the performance of the product as described and published by Focusrite. A Manufacturing Defect does not include damage caused by post-purchase transportation, storage or careless handling, nor damage caused by misuse.

Whilst this warranty is provided by Focusrite the warranty obligations are fulfilled by the distributor responsible for the country in which you purchased the product.

The distributor will then advise you of the appropriate procedure for resolving the warranty issue. In every case it will be necessary to provide a copy of the original invoice or store receipt to the distributor. In the event that you are unable to provide proof of purchase directly then you should contact the reseller from whom you purchased the product and attempt to obtain proof of purchase from them.

Please do note that if you purchase a Focusrite product outside your country of residence or business you will not be entitled to ask your local Focusrite distributor to honour this limited warranty, although you may request an out-of-warranty chargeable repair.

This limited warranty is offered solely to products purchased from an Authorised Focusrite Reseller (defined as a reseller which has purchased the product directly from Focusrite Audio Engineering Limited in the UK, or one of its Authorised Distributors outside the UK). This Warranty is in addition to your statutory rights in the country of purchase.

Registering Your Product

Customer Support and Unit Servicing

Troubleshooting