

S-1

Owner's Manual

Table of contents

S-1 Owner's Manual.....	3	Saving a pattern	47
Panel descriptions	4	Copying, initializing and reloading a pattern	48
Top panel	4	Other useful functions	49
Rear panel	7	Playing arpeggios	49
Playing with the keyboard pads	8	Using the manual function	52
Selecting and playing a pattern.....	9	Looping specific steps (step loop)	53
Selecting a pattern	9	Transposing (key transpose)	54
Setting the tempo	11	Controlling the parameters by tilting this unit (D-MOTION)	55
Creating sounds	12	Configuring D-MOTION.....	55
OSCILLATOR section	12	Adding a rising or falling sound to your performance (Riser)	57
FILTER section	15	Using the metronome	58
AMP section	18	Setting the probability for the entire pattern (master probability)	59
ENV section	19	Using global delay/reverb	60
LFO section	22	Connecting to a computer or mobile device.....	61
Controller section	24	Restoring the factory settings (factory reset)	62
EFX section	26	Backing up and restoring data	63
Creating original waveforms for the oscillator (OSC DRAW)	29	Using the functions.....	64
Chopping a waveform and emphasizing its harmonics (OSC CHOP)	31	Using the menus	67
Editing the notes, performance data and motions ...	32	Knob assignments	70
Inputting with the step pads	34	Main Specifications	71
Editing with the keyboard pads (chord)	36	Signal flow	72
Editing a step	38	MIDI implementation chart	73
Inputting your performance in real time	40		
Editing a step while checking what you played	41		
Deleting a group of notes	43		
Inputting/deleting a motion	44		
Useful sequencer functions.....	45		

S-1 Owner's Manual



© 2023 Roland Corporation

Panel descriptions

Top panel(P.4)

Rear panel(P.7)

Top panel

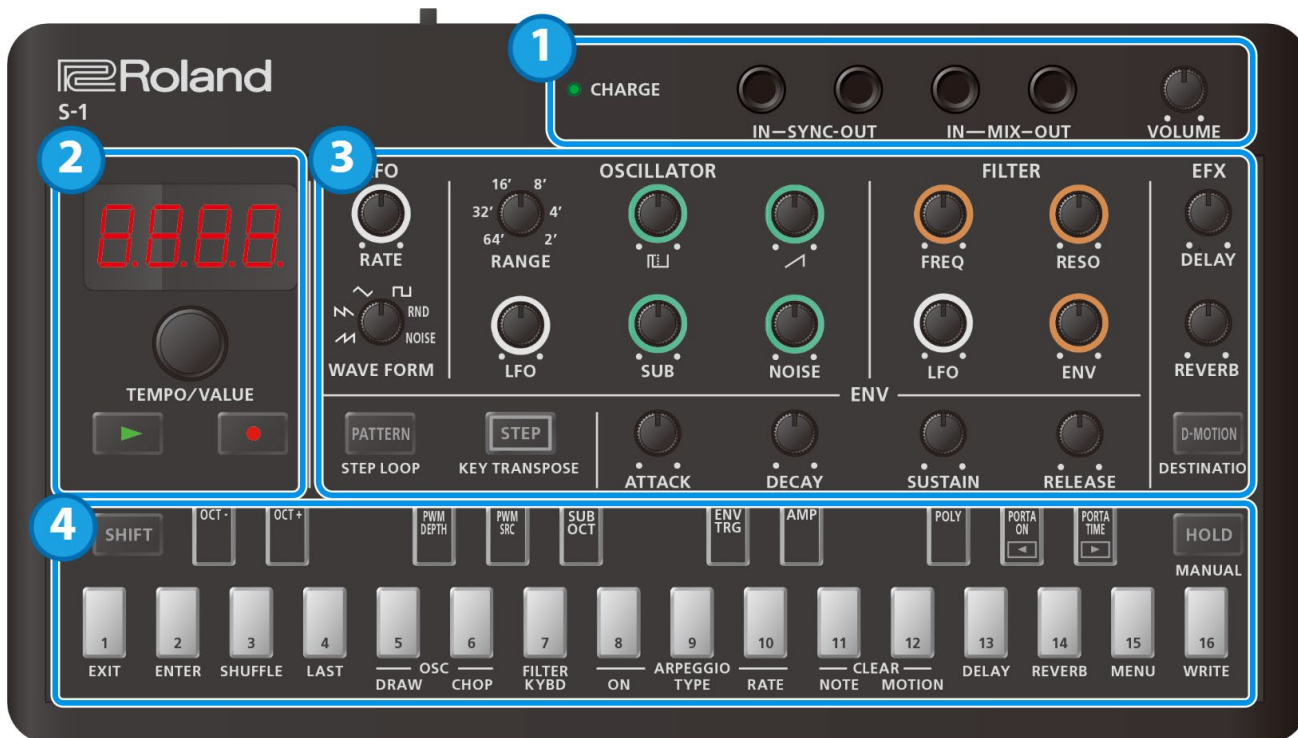

1. Connectors and jacks

Controller	Explanation
CHARGE indicator	<p>When charging via USB port:</p> <p>Orange (lit):Charging.</p> <p>Green (lit): Charging is completed.</p> <p>Green and orange (blinking):A charging error occurred. Please contact your dealer or Roland support. https://roland.cm/roland_support</p> <hr/> <p>When not charging via USB port:</p> <p>Red (lit):The remaining battery power is low. Charge the battery.</p> <p>* The unit powers down within 30 minutes.</p>
SYNC IN jack	Use this jack to input synchronization signals from an external device.
SYNC OUT jack	Use this jack to output synchronization signals to an external device.
MIX IN jack	This is the audio input jack. The sound from connected devices is mixed with the sound of the S-1 and output from the MIX OUT jack.
MIX OUT jack	This is the audio output jack. Connect a pair of headphones here.
[VOLUME] knob	Adjusts the volume of audio coming from the MIX OUT jack.

* To prevent malfunction and equipment failure, always turn down the volume, and turn off all the units before making any connections.

* This product is equipped with a lithium-ion battery.

Even if you do not use this product for an extended period of time, you should charge it once every three months to prevent the internal lithium-ion battery from degrading.

Ambient temperature range during charging

5–35°C





However, in order to take full advantage of the lithium-ion battery's performance, we recommend that you charge it in a temperature range of 10–30°C.

- * Use cables with monaural mini phone type plugs to connect to/from the SYNC IN/OUT jacks. Do not use cables with stereo mini phone type plugs, as these cables do not work.
- * Do not connect an audio device to the SYNC OUT jack. Doing so may cause a malfunction.
- * If an external device is connected to the SYNC IN jack, the unit synchronizes with the clocks inputted to the SYNC IN jack, regardless of the MIDI Clock Sync setting.
- * Use cables with stereo mini phone type plugs to connect to/from the MIX IN/OUT jacks. Do not use cables with monaural mini phone type plugs, as these cables do not work.

2.

Controller	Explanation
Display	This is a four-digit, seven-segment LED display. If a pattern has been edited, a dot lights up on the right side of the display.
[TEMPO/VALUE] knob	Changes the values shown in the display. Use this knob with the [SHIFT] button to fine-tune the tempo or to make larger adjustments to the parameter values.
[▶] (PLAY) button	Plays the pattern. Press the button again to stop playback.
[●] (REC) button	Switches the unit to recording standby. Recording starts when pattern playback begins. When you press a keyboard pad or turn a knob, the corresponding note or parameter change is recorded to the step sequencer.

3.

Section	Controller	Explanation
LFO	[RATE] knob	Determines the LFO's modulation speed.
	[WAVE FORM] knob	Selects the LFO waveform.  (sawtooth wave),  (inverted sawtooth wave),  (triangle wave),  (square wave), RND (random), NOISE (noise)
OSCILLATOR	[RANGE] knob	Sets the octave of the oscillator.
	[LFO] knob	Adjusts the intensity at which LFO modulates the oscillator.
	[■] (Square wave) knob	Adjusts the level of the square wave.
	[▲] (Sawtooth wave) knob	Adjusts the level of the sawtooth wave.
FILTER	[SUB] knob	Adjusts the level of the sub oscillator.
	[NOISE] knob	Adjusts the level of the noise.
	[FREQ] knob	Sets the cutoff frequency of the low-pass filter.
	[RESO] knob	Emphasizes the frequencies around the filter's cutoff frequency.
	[LFO] knob	When the cutoff frequency is set to be controlled by the LFO, this adjusts the intensity.
ENV	[ENV] knob	When the cutoff frequency is set to be controlled by the ENV, this adjusts the intensity.
	[ATTACK] knob	Adjusts the attack time.
	[DECAY] knob	Adjusts the decay time.
	[SUSTAIN] knob	Adjusts the sustain level.
EFX	[RELEASE] knob	Adjusts the release time.
	[DELAY] knob	Adjusts the delay volume.
	[REVERB] knob	Adjusts the volume of the reverb.

Section	Controller	Explanation
	[D-MOTION] (DESTINATION) button	Turns the D-MOTION function on/off, which controls the tones according to the angle at which this unit is tilted. For details, refer to “ Controlling the parameters by tilting this unit (D-MOTION)(P.55) ”. * When using the D-MOTION function, firmly grip both sides of this unit and be careful that the connected cables are not excessively bent. Use this with the [SHIFT] button to bring up the DESTINATION screen, where you can configure D-MOTION.
	[PATTERN] (STEP LOOP) button	Turn this on (the button lights up) to switch to pattern select mode. Use this with the [SHIFT] button for using the STEP LOOP function.
	[STEP] (KEY TRANSPOSE) button	When this button is lit, the white keyboard pads function as step pads [1]–[16]. Use this with the [SHIFT] button to configure KEY TRANSPOSE.

MEMO

By turning the knobs while holding down the [SHIFT] button, you can access tone parameters that are different from the normal parameters. There is also a way to check the setting value without modifying them.
For details, refer to “[Knob assignments\(P.70\)](#)”.

4.

Controller	Explanation
[SHIFT] button	Hold down the [SHIFT] button while pressing the various buttons to set the parameters and execute different functions.
[HOLD] (MANUAL) button	Turns the keyboard pad hold function on/off. Press the [SHIFT] + [HOLD] buttons for manual operations. When doing so, the current knobs positions are applied to the tone of the selected pattern. Only the parameters accessible from the top panel knobs are applied to the pattern. * This has no effect on the parameters that are set in combination with the [SHIFT] button (Knob assignments(P.70)).
Keyboard pads	Use these to play notes as with a regular keyboard, or use the pads to specify a scale and record to the sequencer. When the [STEP] button is lit, the white keys operate as step pads [1]–[16]. You can also use the pads along with the [SHIFT] button to set the parameters and execute different functions. Refer to “ Using the functions(P.64) ” and “ Using the menus(P.67) ” for an overview.

Rear panel

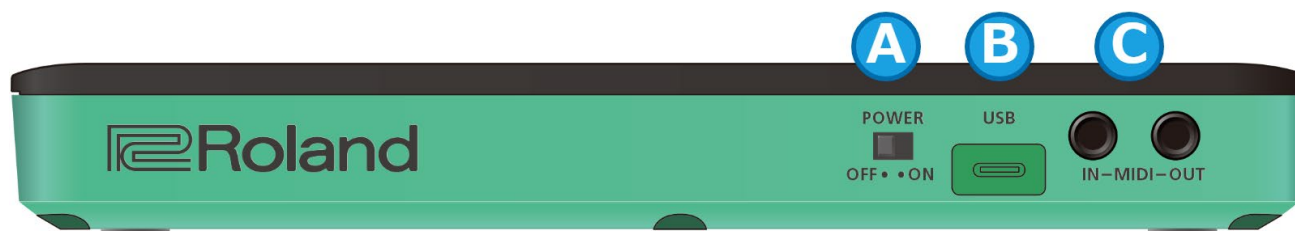

A. [POWER] switch

Turns the power on/off.

B. USB port (USB Type-C®)

Use a commercially available USB 2.0 cable (Type-A to C, or Type-C to C) to connect this port to your computer.

This is used to transfer USB MIDI and USB audio data.

- * Do not use a USB cable that is designed only for charging a device. Charge-only cables cannot transmit data.

If you're powering this unit via the USB port, this charges the battery. To check the battery status, refer to "CHARGE indicator(P.4)".

NOTE

- * When charging this unit, connect to the USB port on your computer or use a commercially-available USB power adaptor (at least 5 V, 500 mA).

Do not use a fast-charging USB power adaptor (which outputs at voltages higher than 5 V) to charge this unit, as this may cause the unit to malfunction.

- * Charge the device using the included USB cable.

C. MIDI IN/MIDI OUT jacks

Use TRS/TRS (BCC-1-3535 or BCC-2-3535, sold separately) or TRS/MIDI connecting cables (BMIDI-5-35, BMIDI-1-35 or BMIDI-2-35, sold separately) to connect this unit to an external MIDI device.

You can make this unit play in sync with a MIDI device by connecting the devices with a commercially available MIDI cable.

- * Do not connect audio devices to these jacks. Doing so may cause a malfunction.

Playing with the keyboard pads

You can use the keyboard pads to play notes on this unit right after turning it on.

The tempo is shown on the display.

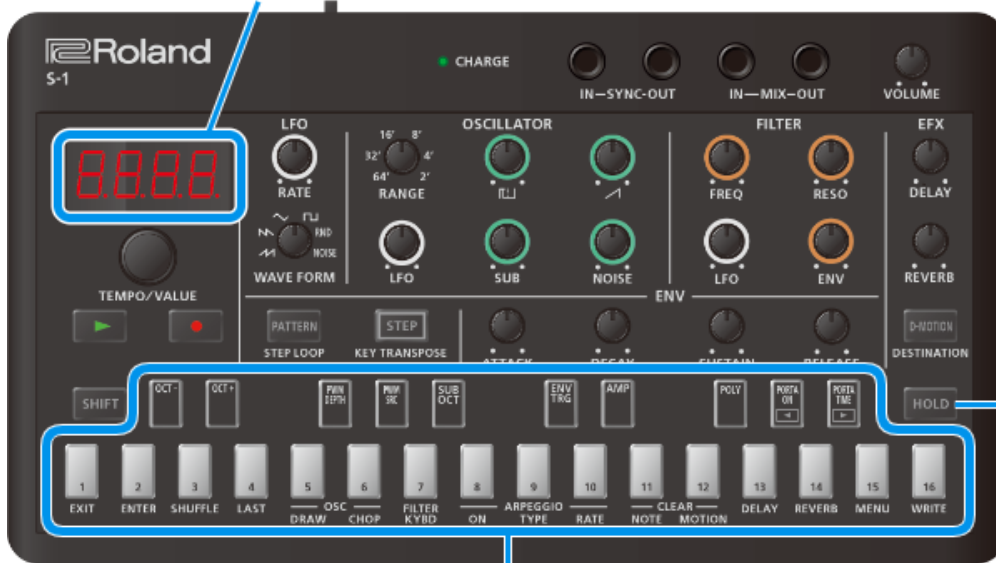

[HOLD] button

When this is lit, the keyboard pads act as if they are still pressed down, even after you take your finger off them.

Play using the keyboard pads.

Switching the octave



1. Hold down the [SHIFT] button and press the [OCT-] [OCT+] pads.

Setting range: -4 to +4 octaves

MEMO

By holding down the [SHIFT] button and pressing the [OCT-] pad and the [OCT+] pad, you can reset the octave setting (to zero). (Ver. 1.02)

Selecting and playing a pattern

Selecting a pattern(P.9)

Setting the tempo(P.11)

Selecting a pattern

What's a pattern?

On the S-1, the performance data (sequence) in the sequencer as well as the tones (sounds) used in performance are handled together as a single set of data.

This is called a "pattern".

The patterns are arranged in banks (1–4) and numbers (1–16), for a total of 64 patterns.

This unit contains the following data by factory default.

Bank number	Explanation
1-01–1-16	Preset patterns (can be overwritten)
2-01 – 4-16	Empty patterns

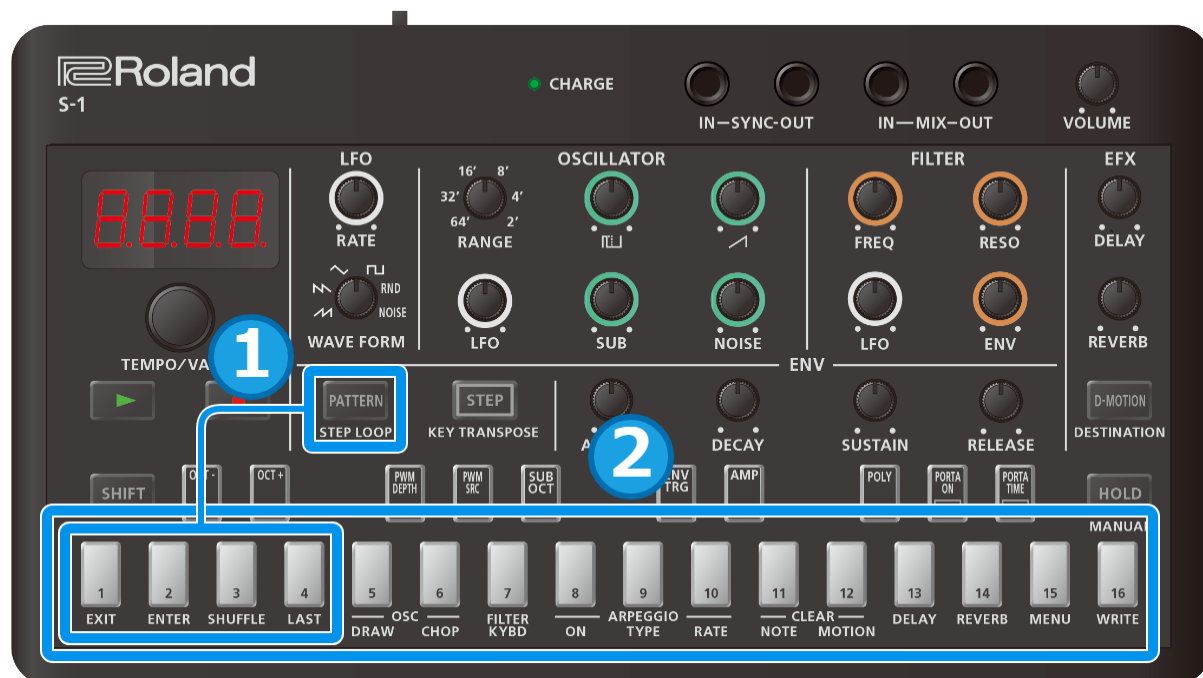

1. Hold down the [PATTERN] button and press the [1]–[4] pads to select a bank.

The pad of the selected bank lights up while you press the [PATTERN] button, and the pads for the other banks blink. If you're holding down the [PATTERN] button but then remove your finger from the button without selecting a bank, you can then proceed to step 2 (selecting the number) without changing the bank.

2. Take your finger off the [PATTERN] button and use the [1]–[16] pads to select the number.

When you change the pattern while another pattern is still playing, this specifies which pattern is to be reserved (played next).

Once the current pattern finishes playing, the next pattern you reserved automatically begins playing.

When the [PATTERN] button is lit

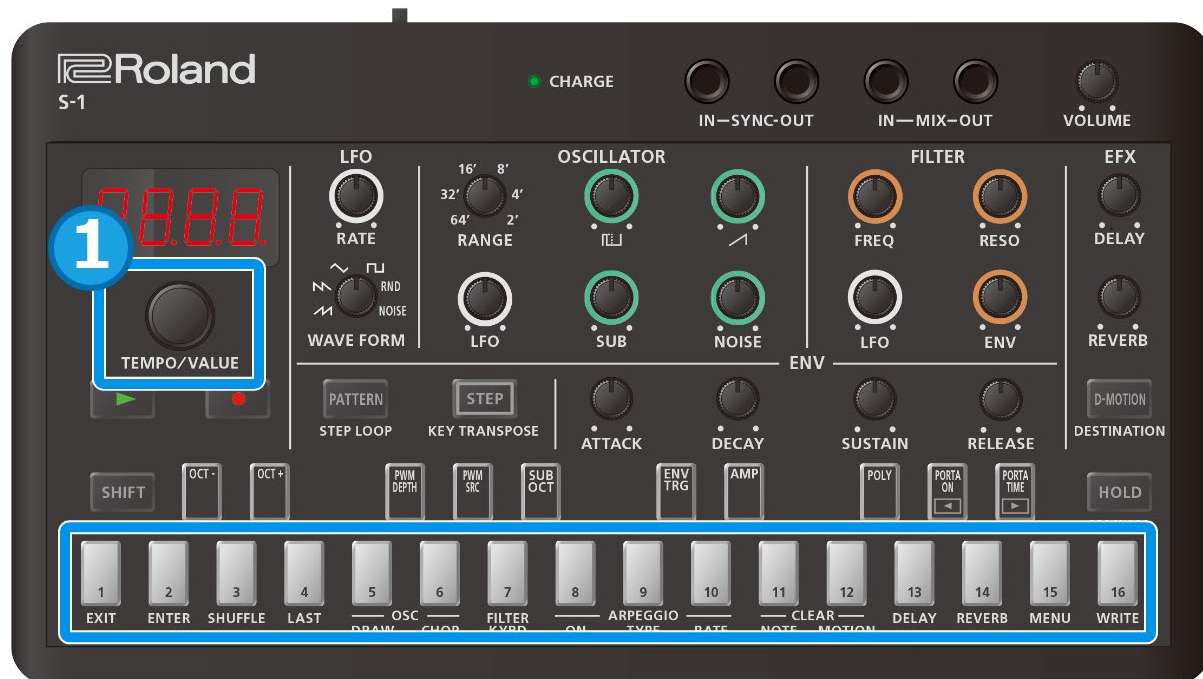

1. Turn the [TEMPO/VALUE] knob to select a pattern.

You can also use the [1]–[16] pads to select the number.

Setting the tempo

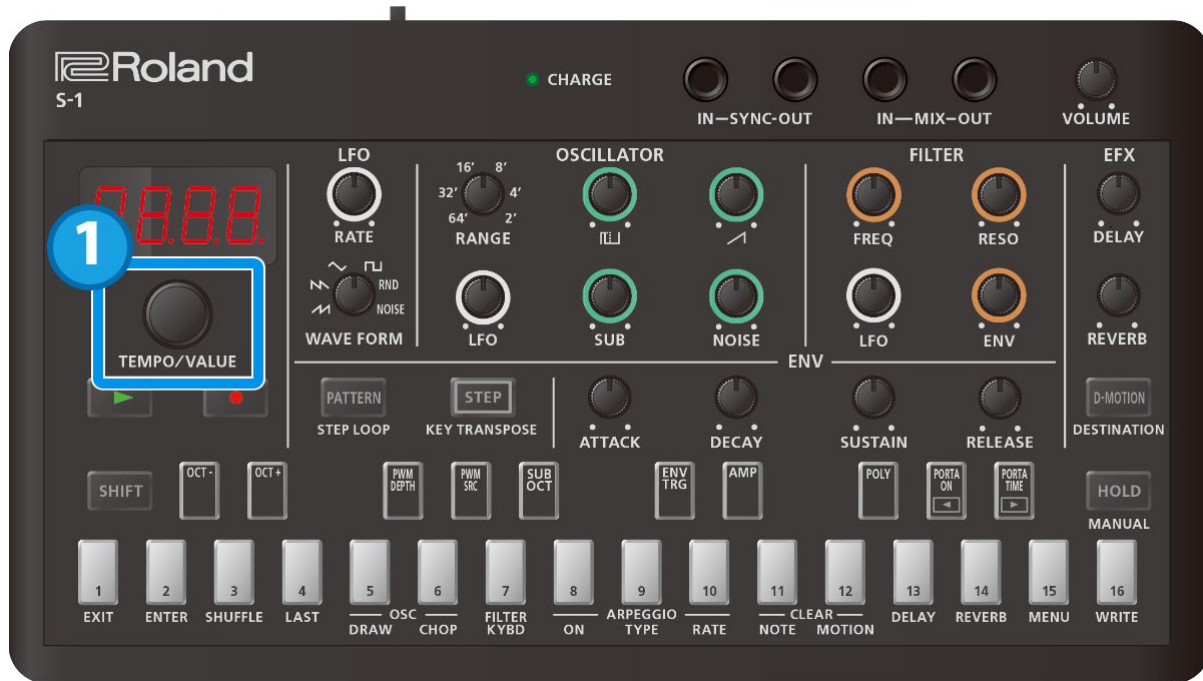

1. Turn the [TEMPO/VALUE] knob to set the tempo.

MEMO

Hold down the [SHIFT] button and turn the [TEMPO/VALUE] knob to fine-tune the value. The value can be adjusted (fine-tuned) in steps of 0.1.

Creating sounds

The S-1 features a number of functions you can use to create sounds. The tones you create are saved to each pattern.

The performance data and tones from the factory settings (presets) are saved in patterns 1-01 through 1-16.

MEMO

When you want to create a sound from scratch, we recommend that you either select an empty pattern from 2-01 onward, or initialize a pattern.

- [Selecting a pattern](#)(P.9)
- [Initializing a pattern](#)(P.48)

[OSCILLATOR section](#)(P.12)

[FILTER section](#)(P.15)

[AMP section](#)(P.18)

[ENV section](#)(P.19)

[LFO section](#)(P.22)

[Controller section](#)(P.24)

[EFX section](#)(P.26)

[Creating original waveforms for the oscillator \(OSC DRAW\)](#)(P.29)

[Chopping a waveform and emphasizing its harmonics \(OSC CHOP\)](#)(P.31)

OSCILLATOR section

The OSCILLATOR section features an oscillator (hereafter “OSC”) with variable pitch (frequency). The OSC generates the basic waveform used as the sound source for the synthesizer.

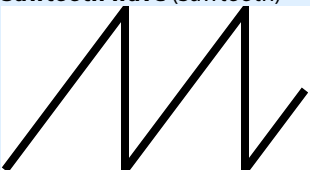
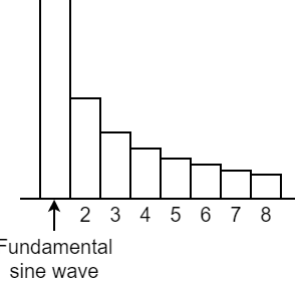
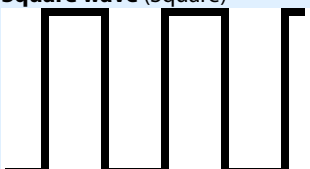
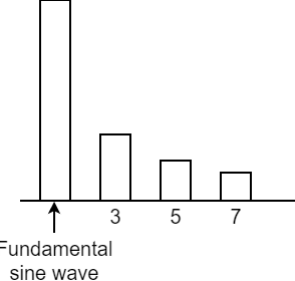
Waveform	Waveform characteristics	Harmonic structure
<p>Sawtooth wave (Sawtooth)</p> 	<p>Sawtooth waves are composed of a fundamental sine wave and the sine waves of the integer harmonics, all at a fixed ratio. The way that these waves are structured is shown at the graph at right. The wave includes the nth harmonic at a volume of 1/n, with the fundamental wave considered as “1”.</p>	
<p>Square wave (Square)</p> 	<p>Square waves are composed of a fundamental sine wave and the sine waves of the odd-numbered harmonics, all at a fixed ratio. For the nth harmonic, the sine waves are included at a ratio of 1/n, the same as for the sawtooth wave. However, the even-numbered harmonics are left out entirely.</p>	

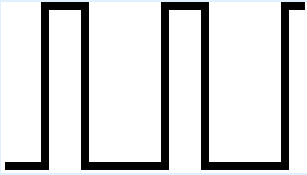
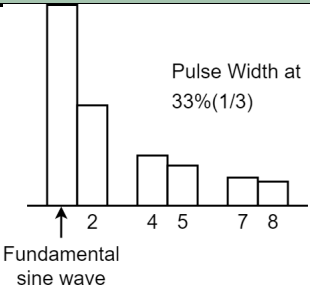
Waveform	Waveform characteristics	Harmonic structure
<p>Asymmetrical square wave</p> 	<p>For asymmetrical square waves, the harmonic composition changes greatly depending on the ratio of the upper and lower widths.</p> <p>These waveforms characteristically drop the nth harmonic series is dropped when the upper width is 1/n that of the entirety.</p> <p>The graph at right shows that with a width of 1/3 (33%), the third, sixth and ninth harmonics are dropped.</p>	

[RANGE] knob

This knob switches between frequency ranges for the oscillator.

By switching the settings from 64' all the way down to 2', you can change the tonal range in octaves.

When this is set to 8', the pitch of the lowest C (keyboard pad [2]) is equivalent to middle C (MIDI note number: 60) on a piano (with Transpose set to "0").

MEMO

You can turn the [RANGE] knob while holding down the [SHIFT] button to alter the pitch within a ±1 octave range (this works as a FINE TUNE knob).

Setting the pulse width control source (PWM SRC)

What's "pulse width"?

A square wave whose upper and lower widths are not the same is called an "asymmetrical square wave". "Pulse width" refers to how wide the upper width is compared to the entire wave, expressed as a percentage.

The harmonic structure changes greatly depending on this value, as does the sound.

This pulse width is used at a fixed preset value, but you can apply time-based changes to the pulse width with the LFO or envelope generator signal.

This is called "pulse width modulation" (PWM).

Use the PWM source switch to select whether to set the pulse width to a fixed preset value ("PRn"), or to apply time-based changes using the LFO ("LFO") or envelope generator ("Enu") signals.

1. Hold down the [SHIFT] button and press the [PWM SRC] pad.
2. Turn the [TEMPO/VALUE] knob to edit the value.

Value	Explanation
Enu	Changes by the signal of the envelope generator over time. Use the PWM DEPTH parameter to adjust the depth of the effect.
PRn	Specifies a fixed value, set in PWM DEPTH.
LFO	Changes by the signal of the LFO over time.

Setting the pulse width value or modulation (PWM DEPTH)

Here's how to set the pulse width value and modulation depth.

1. Hold down the [SHIFT] button and press the [PWM DEPTH] pad.
2. Turn the [TEMPO/VALUE] knob to edit the value.

Value	Explanation
0-255	Sets the pulse width value when PWM SOURCE is "PRn". When using the "LFO" or "Enu" setting, this adjusts the modulation depth.

Creating original waveforms for the oscillator (OSC DRAW)

→ [Creating original waveforms for the oscillator \(OSC DRAW\)](#)(P.29)

Chopping a waveform and emphasizing its harmonics (OSC CHOP)

→ [Chopping a waveform and emphasizing its harmonics \(OSC CHOP\)](#)(P.31)



[LFO] knob

This knob adjusts the modulation intensity, when you use the modulator signal from the LFO section to control the fundamental frequency (pitch) of the OSC.

The method of change depends on the setting of the [WAVE FORM] knob in the LFO section.

Mixing the output from the oscillator (source mixer)

Four waveforms are always output from the OSC, and you can mix their levels in the ratio you like. The source mixer output is sent to the FILTER section.

Controller	Explanation
 (square wave) knob	Adjusts the level of the square wave or the original waveform you create using OSC DRAW.
 (sawtooth wave) knob	Adjusts the level of the sawtooth wave.
[SUB] knob	Adjusts the level of the sub oscillator.
[NOISE] knob	Adjusts the level of the noise.

Selecting the output waveform for the sub-oscillator (SUB OCT)

This shows how to select the sub-oscillator output waveform.

1. **Hold down the [SHIFT] button and press the [SUB OCT] pad.**
2. **Turn the [TEMPO/VALUE] knob to edit the value.**

Value	Explanation
-20A	-2 octave asymmetrical waveform
-20C	-2 octave symmetrical waveform
-10C	-1 octave symmetrical waveform

Selecting a noise output waveform (Noise Mode)

Here's how to select the noise output waveform.

1. **Hold down the [SHIFT] button and press pad [15] (MENU).**
2. **Use the [TEMPO/VALUE] knob to select "n5nd" (Noise Mode), and press pad [2] (ENTER).**
3. **Turn the [TEMPO/VALUE] knob to edit the value.**

Value	Explanation
P 1nE	Pink noise
Wh iE	White noise

FILTER section

The FILTER section is used for reducing or emphasizing harmonic components in the original sound that's mixed in the OSC section, and to alter the tone.

This lets you pass the lower frequencies through while cutting the higher frequencies (LPF: Low-Pass Filter).

[FREQ] knob

This knob sets the cutoff point (cutoff frequency) for the filter.

Turning the knob counterclockwise cuts the higher frequencies and makes the waveform closer to that of a sine wave. At the minimum setting, there is no sound.

[RESO] (Resonance) knob

Emphasizes the frequencies around the cutoff point that you set using the [FREQ] knob.

Turning the knob clockwise emphasizes specific harmonic components, adding character to the sound.

In particular, when you move the cutoff point while the resonance is raised, you can get a sound that's unique to synthesizers.

Also, if you raise the resonance to maximum, the filter oscillates at the cutoff point.

[LFO] knob

This adjusts the intensity (depth) when controlling the filter's cutoff point with the modulator signal from the LFO section.

The method of change for the cutoff point depends on the setting of the [WAVE FORM] knob in the LFO section.

[ENV] (envelope depth) knob

This adjusts the intensity (depth) when controlling the filter's cutoff point with the envelope generator's signal.

Turn the knob clockwise to change the filter cutoff point according to the ADSR pattern (the combination of settings for the four knobs in the ENV section), which you set beforehand for each note you play.

Use this to make changes in the sound over a short time within single notes.

Changing the cutoff point according to the pitch (FILTER KYBD: filter keyboard follow)

This parameter adjusts the intensity (depth) when controlling the filter's cutoff point with the pitch signals generated by the keyboard.

By making the cutoff point follow the pitch of the notes played, you can keep the same harmonic components.

For instance, when you play a high note while the cutoff point is set to a lower frequency range, the cutoff point doesn't change even when the fundamental frequency changes, thus creating large changes in the sound.

If you don't want this to happen, increase the filter keyboard follow value.

1. **Hold down the [SHIFT] button and press pad [7] (FILTER KYBD).**
2. **Turn the [TEMPO/VALUE] knob to edit the value.**

Value	Explanation
0–255	Changes the filter cutoff point according to the notes played on the keyboard. Larger values make the harmonic components change less in response to the notes you play. A value of "255" makes the cutoff point perfectly follow the pitch.

Cutoff point (cutoff frequency)

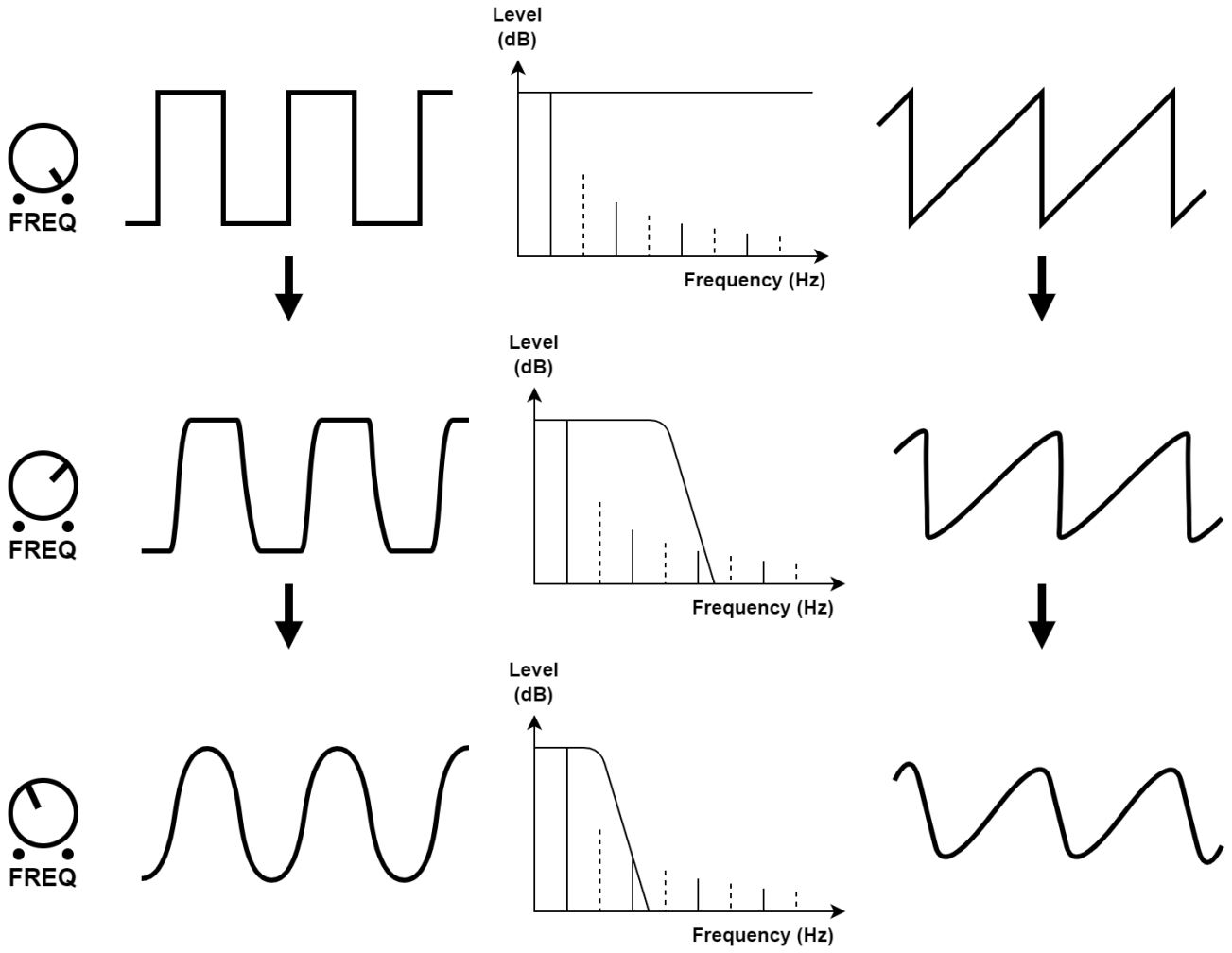

Resonance

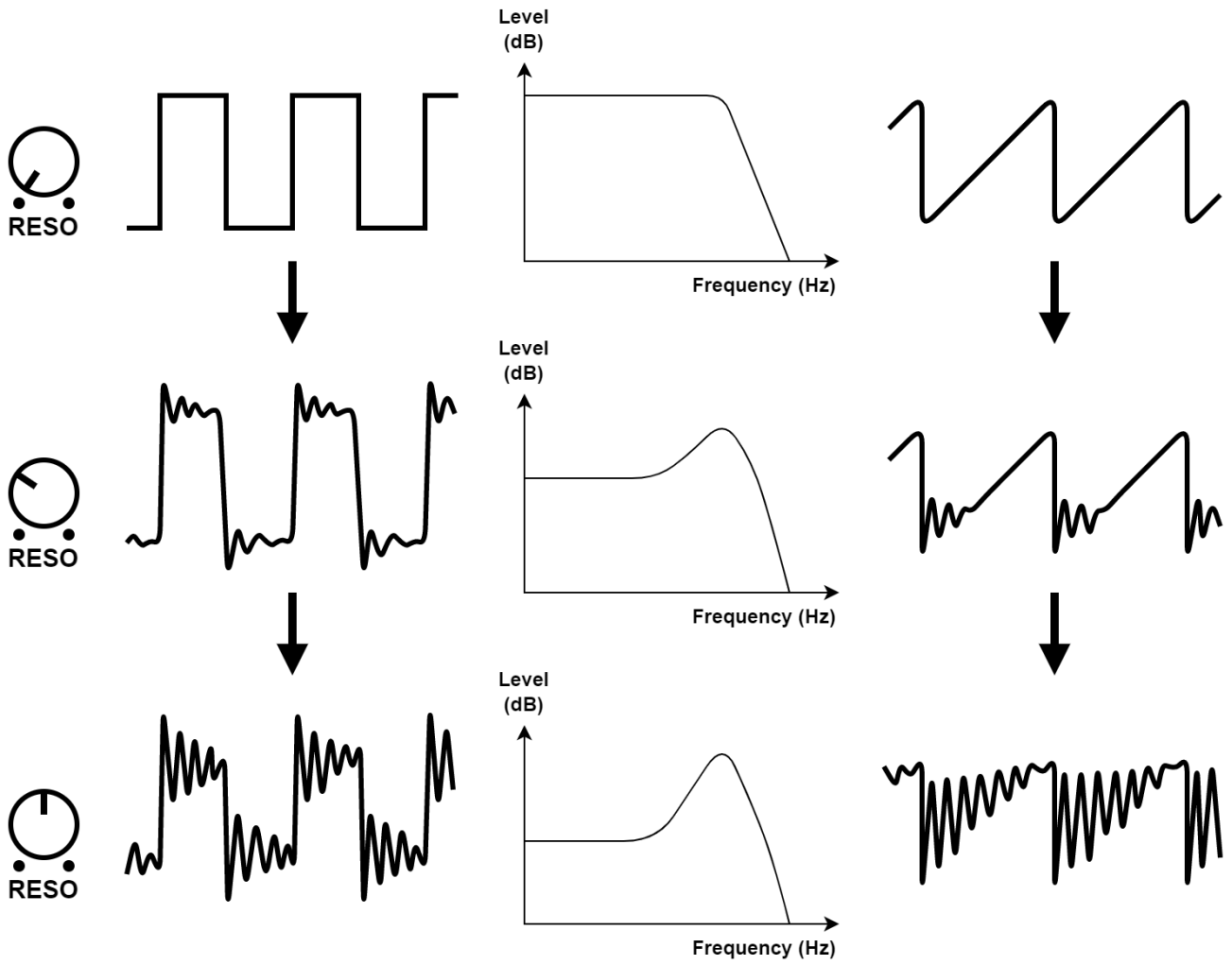

AMP section

This section controls the volume of the sound, letting you change the attack and decay of the sound by controlling the output signal from the standard envelope generator.

Switching between AMP control sources

Use these steps to select whether to control the AMP by using the envelope generator signal ("ENV") or by using the gate signal ("GATE").

1. Hold down the [SHIFT] button and press the [AMP] pad.
2. Turn the [TEMPO/VALUE] knob to edit the value.

Value	Explanation
GATE	Controls the AMP by using the gate signal.
ENV	Controls the AMP by using envelope generator signal.

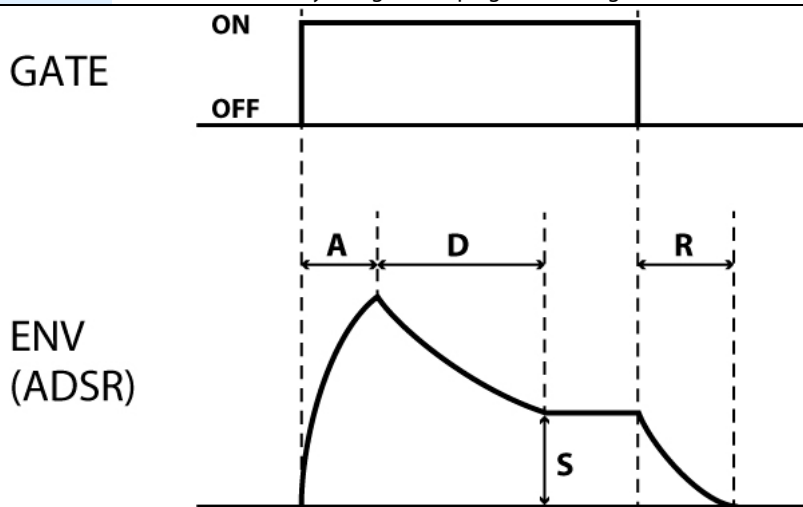

ENV section

This section creates control signals to make time-based changes to the sound.

These signals are generated when you play the keyboard pads. The signals control the FILTER and AMP sections to change the sound and volume of each note you play over time.

[ATTACK] knob (A)

This knob sets the time (attack time) it takes for the control signal to reach its peak level after you press a keyboard pad.

[DECAY] knob (D)

This knob sets the time (decay time) it takes for the control signal to reach the sustain level after reaching its peak level.

The decay time is closely related to the sustain level. When you adjust the [DECAY] knob while the sustain is set to the highest level, the envelope shape doesn't change.

[SUSTAIN] knob (S)

This knob sets the sustain level, which is the level that the sound stays at after the envelope reaches its peak.

The level is held as long as you hold down the keyboard pad.

[RELEASE] knob (R)

This knob sets the time (release time) it takes for the control signal to drop to zero (where the envelope reaches its end) after you release the keyboard pad.

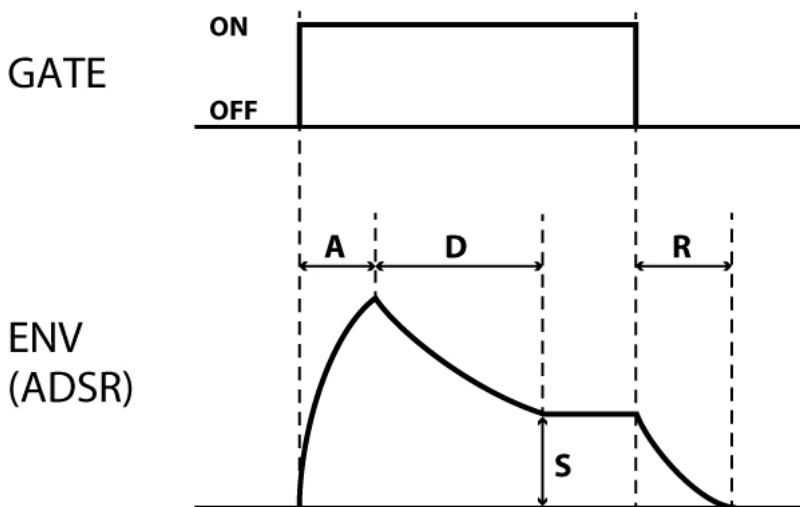

ADSR settings and envelope waveforms

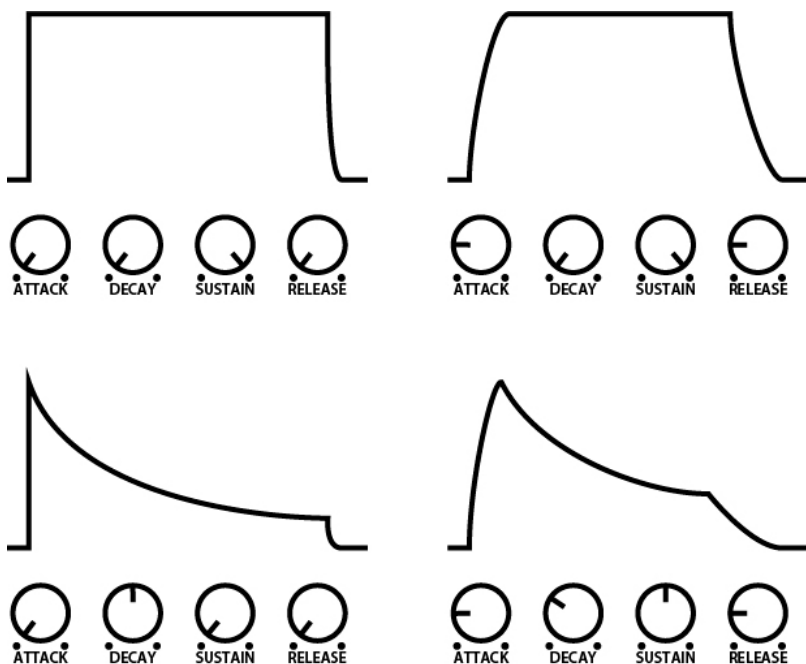

When the [ATTACK] knob, [DECAY] knob, [SUSTAIN] knob and [RELEASE] knob are all set to “0”, an extremely short pulse wave is generated, producing a click noise.

Selecting the signal used to control the envelope (ENV TRG: envelope trigger)

Follow these steps to select which signal is used for controlling the envelope generator.

1. **Hold down the [SHIFT] button and press the [ENV TRG] pad.**
2. **Turn the [TEMPO/VALUE] knob to edit the value.**

Value	Explanation
LFO	<p>LFO</p> <p>The envelope generator operates repeatedly, following the LFO rate (cycle) of the modulator.</p> <p>With this setting, the envelope repeats its attack phase while you’re holding down a keyboard pad, and the envelope stops when you release the pad.</p> <p>Each time you play a keyboard pad again (after completely taking your finger off a pad and then playing the next pad), the envelope always returns to the beginning (attack phase), regardless of what’s going on with the LFO.</p>
LFO	<p>The diagram shows three signals over time. The KEY signal is a square wave that goes high and then low. The LFO signal is a square wave that oscillates between high and low. The ENV Output signal shows a series of envelope pulses that occur only when the KEY signal is high, and each pulse starts at the beginning of the attack phase, regardless of the LFO's state.</p>

Value Explanation

GATE

When in POLY mode, if you've selected a mode besides "POLY", the envelope goes to its attack phase each time you play a keyboard pad (completely taking your finger off a pad and then playing the next pad). If you want to make tonal or time-based changes to each note, you must play in a non-legato style.

GATE

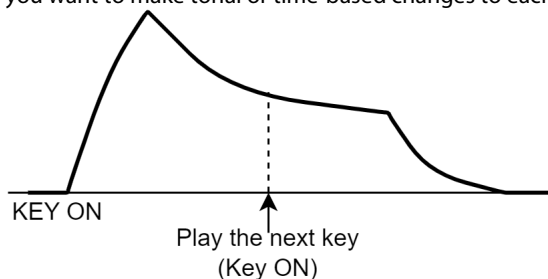

If "POLY" is selected while the unit is in POLY mode, time-based changes are applied to the volume or tonal quality of each note you play, regardless of whether you play in a legato or non-legato style.

GATE+TRIG

If you play a keyboard pad while holding down a different keyboard pad, the envelope is retriggered for the new note you played. In other words, this lets you make tonal or time-based changes to each note you play, regardless of whether you play in a legato or non-legato style.

GATE

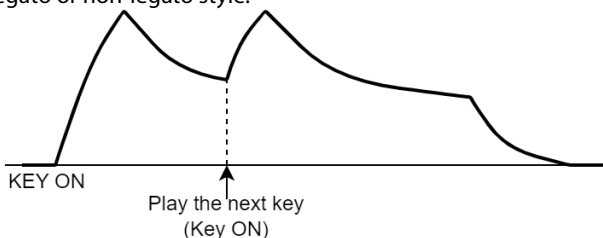

NOTE

When "Hold", "Un i", or "Chd" are selected in POLY mode

If this unit is in POLY mode and you select "Hold", "Un i", "Chd" for inputting single notes, the unit behaves as shown below when you input more than one note.

When ENV TRG is LFO or GATE	You can use the Note Priority setting ("nPr i" in the menu) to select between giving priority to either the last note (LRS) or the lowest note (LDB) that you play.
When ENV TRG is GATE+TRIG	The unit gives priority to the last note you played, meaning that whichever keyboard pad you played last is always given priority.



LFO section

The modulator consists of the LFO (low-frequency oscillator), RANDOM and NOISE, and produces signals for controlling the OSC and FILTER sections.

Aside from this, the LFO can also output a sine wave, so that you can control OSC or FILTER when receiving MIDI modulation or pitch bend messages.

[WAVE FORM] knob

Use this switch to select the modulator output signal.

The waveforms from  (sawtooth wave) to  (square wave) are LFO output waveforms. These waveforms control the OSC or FILTER to create vibrato, trills, growling sounds and other effects.

With the RND (RANDOM) setting, the unit outputs a control signal that changes randomly, which is used to produce random notes (OSC) or random filter (FILTER) effects.

With the NOISE setting, the noise generator signal is used without change as a control signal, producing finely vibrating modulation (noise modulation).

[RATE] knob

This knob sets the LFO and RANDOM speed (frequency).

If “LFO Sync” is “OFF”, the LFO operates at a speed according to the value that’s set (0–255).

If “LFO Sync” is “ON”, the LFO operates at the selected note length, according to the tempo.

Note lengths

Display	Explanation
<i>8_ 1</i>	Octuple whole note
<i>6_ 1</i>	Sextuple whole note
<i>8_ 1t</i>	Octuple whole-note triplet
<i>4_ 1</i>	Quadruple whole note
<i>3_ 1</i>	Triple whole note
<i>4_ 1t</i>	Quadruple whole-note triplet
<i>2_ 1</i>	Double whole note
<i>1d</i>	Dotted whole note
<i>2_ 1t</i>	Double whole-note triplet
<i>1_ 1</i>	Whole note
<i>2d</i>	Dotted half note
<i>1t</i>	Whole-note triplet
<i>1_ 2</i>	Half note
<i>4d</i>	Dotted quarter note
<i>2t</i>	Half-note triplet
<i>1_ 4</i>	Quarter note
<i>8d</i>	Dotted eighth note
<i>4t</i>	Quarter-note triplet
<i>1_ 8</i>	Eighth note
<i>16d</i>	Dotted sixteenth note
<i>8t</i>	Eighth-note triplet
<i>1_ 16</i>	Sixteenth note
<i>32d</i>	Dotted thirty-second note
<i>16t</i>	Sixteenth-note triplet
<i>1_ 32</i>	Thirty-second note
<i>64d</i>	Dotted sixty-fourth note
<i>32t</i>	Thirty-second-note triplet
<i>1_ 64</i>	Sixty-fourth note
<i>128d</i>	Dotted 128th note
<i>64t</i>	Sixty-fourth-note triplet
<i>128</i>	128th note

When you change the RATE while you’re playing, the LFO may not be in time with your performance. If this happens, stop the sequencer and then start it again.

LFO Mode (MENU – LFO.1)

This selects how quickly the LFO changes when LFO Sync is “OFF”.

This is disabled when LFO Sync is “ON”.

Value	Explanation
<i>nor</i>	Normal mode. This produces the regular LFO cycle.
<i>FAST</i>	Fast mode. This emphasizes the sense of modulation by increasing the LFO cycle to an extreme degree.

LFO Sync (MENU – LFO.5)

Sets whether to sync the LFO cycle to the tempo.

LFO Key Trigger (MENU – LFO.4)

Sets whether to reset the LFO when a note sounds.

Controller section

Setting the sound triggering mode (POLY)

This shows how to set the way that the sound source is triggered when one or more notes are played (input) using the keyboard pads or the sequencer.

1. Hold down the [SHIFT] button and press the [POLY] pad.
2. Turn the [TEMPO/VALUE] knob to edit the value.

Value	Explanation
<i>Mono</i> (Mono)	Monophonic mode. Plays single tones.
<i>Unison</i> (Unison)	Unison mode. Stacks multiple tones to play a layered note.
<i>Poly</i> (Poly)	Polyphonic mode. Lets you play more than one tone at the same time (up to four voices).
<i>Chd</i> (Chord)	Chord mode. Plays voices 2–4 at the same time for each note that you play, according to the parameter settings below.

Press pad [2] (ENTER) while “Chd” is shown in the display to configure the following parameters.

Value	Explanation
<i>u25H</i> (Voice 2 SW)	Turns the sound of voice 2 on/off.
<i>u2L5</i> (Voice 2 Key Shift)	Transposes the key of voice 2 (range: -12–0–12).
<i>u35H</i> (Voice 3 SW)	Turns the sound of voice 3 on/off.
<i>u3L5</i> (Voice 3 Key Shift)	Transposes the key of voice 3 (range: -12–0–12).
<i>u45H</i> (Voice 4 SW)	Turns the sound of voice 4 on/off.
<i>u4L5</i> (Voice 4 Key Shift)	Transposes the key of voice 4 (range: -12–0–12).

Setting how portamento works (PORTAMENTO)

Portamento is an effect that makes one pitch glide smoothly into another.

1. Hold down the [SHIFT] button and press the [PORTA ON] pad.
2. Turn the [TEMPO/VALUE] knob to edit the value.

Value	Explanation
<i>OFF</i>	Portamento is not applied, regardless of the portamento time setting.
<i>On</i>	Portamento is always applied.
<i>Auto</i>	Portamento operates only when you play in a legato style (or in other words, when you play the next keyboard pad before you completely take your finger off the previous keyboard pad). You can control whether portamento is applied (ON) or not (OFF) by the way that you play.

Setting the portamento time (PORTAMENTO TIME)

Follow these steps to change how much time it takes (portamento time) to glide smoothly between pitches.

1. Hold down the [SHIFT] button and press the [PORTA TIME] pad.
2. Turn the [TEMPO/VALUE] knob to edit the value (0–255).

Changing the tonal range when you play (TRANSPOSE)

This parameter lets you move the tonal range of the keyboard pads or of the sequencer within a range of ± 60 half steps (± 5 octaves).

This also changes the FILTER KYBD (filter keyboard follow) value in the FILTER section.

1. **Hold down the [SHIFT] button and press the [STEP] button.**
2. **Turn the [TEMPO/VALUE] knob to edit the value (-60-60).**

At this time, you can also hold down the [SHIFT] button and press a keyboard pad to make this setting within a range of -12 to +12. (Ver. 1.02)

This is useful when you want to quickly transpose the pitch while a pattern is playing.

Setting the modulation depth (LFO Modulation Depth)

When the OSC or FILTER receive D-MOTION signals or MIDI modulation, they are controlled by the LFO sine wave output (producing vibrato or growl effects).

This parameter sets the intensity.

1. **Hold down the [SHIFT] button and press pad [15] (MENU).**
2. **Use the [TEMPO/VALUE] knob to select “*Mod.d*”, and press pad [2] (ENTER).**
3. **Turn the [TEMPO/VALUE] knob to edit the value (0-255).**

Setting the variable range of the pitch bend (Oscillator Bend Sens)

This sets the variable range when you control the oscillation frequency (pitch) of the OSC using D-MOTION or MIDI pitch bend signals (over a maximum of ± 2 octaves).

1. **Hold down the [SHIFT] button and press pad [15] (MENU).**
2. **Use the [TEMPO/VALUE] knob to select “*bnd.o*”, and press pad [2] (ENTER).**
3. **Turn the [TEMPO/VALUE] knob to edit the value (0-240).**

120: ± 1 oct, 240: ± 2 oct

Setting the variable range when using pitch bend to control the cutoff frequency (Filter Bend Sens)

This sets the variable range when you control the filter's cutoff point using D-MOTION or MIDI pitch bend signals.

1. **Hold down the [SHIFT] button and press pad [15] (MENU).**
2. **Use the [TEMPO/VALUE] knob to select “*bnd.F*”, and press pad [2] (ENTER).**
3. **Turn the [TEMPO/VALUE] knob to edit the value (0-255).**

EFX section

You can use effects to add spatial depth or a more expansive feel to the sound.

The S-1 features three kinds of built-in effects, including delay, reverb and chorus.

[DELAY] knob

This adds an echoing effect by delaying the sound and repeating the delay.

1. Use the [DELAY] knob to adjust the volume of the delay sound (d0-d255).

MEMO

You can set the delay time by turning the [DELAY] knob while holding down the [SHIFT] button.

Configuring the delay (DELAY)

1. Hold down the [SHIFT] button and press [13] (DELAY) pad.
2. Use the [TEMPO/VALUE] knob to select a parameter, and then press pad [2] (ENTER).
3. Turn the [TEMPO/VALUE] knob to edit the value.

Parameter	Value	Explanation
d54n (Delay Sync)	OFF, ON	Synchronizes the delay time to the tempo.
t, nE (Time)	When Delay Sync is OFF:1-740 (ms) When Delay Sync is ON:(note value) *1	Sets the delay time.
LEu (Level)	0-255	Adjusts the volume of the delay sound. MEMO You can use the "Delay Level Mode(P.68)" setting to select whether to control the input or the output of the delay.
FdbE (Feedback)	0-255	Adjusts the amount of feedback (repetition).
LaLE (Low Cut)	FLRE, 20, 25, 31.5, 40, 50, 63, 80, 100, 125, 160, 200, 250, 315, 400, 500, 630, 800 (Hz)	Cuts the frequencies below the frequency that you set. No frequencies are cut when this is set to "FLRE".
H, LE (High Cut)	630, 800, 1k, 1.25k, 1.6k, 2k, 2.5k, 3.15k, 4k, 5k, 6.3k, 8k, 10k, 12.5k (Hz), FLRE	Cuts the frequencies above the frequency that you set. No frequencies are cut when this is set to "FLRE".

*1: Note lengths

Display	Explanation
1_4	Quarter note
8d	Dotted eighth note
4E	Quarter-note triplet
1_8	Eighth note
16d	Dotted sixteenth note
8E	Eighth-note triplet
1_16	Sixteenth note
32d	Dotted thirty-second note
16E	Sixteenth-note triplet
1_32	Thirty-second note
64d	Dotted sixty-fourth note
32E	Thirty-second-note triplet
1_64	Sixty-fourth note
128d	Dotted 128th note
64E	Sixty-fourth-note triplet
128	128th note

[REVERB] knob

This effect produces reverberation, like being in a hall or room.

1. Turn the [REVERB] knob to adjust the volume of the reverb (r0-r255).

MEMO

Adjust the reverb length (time) by turning the [REVERB] knob while holding down the [SHIFT] button.

Configuring the reverb (REVERB)

1. Hold down the [SHIFT] button and press pad [14] (REVERB).
2. Use the [TEMPO/VALUE] knob to select a parameter, and then press pad [2] (ENTER).
3. Turn the [TEMPO/VALUE] knob to edit the value.

Parameter	Value	Explanation
TYPE (Type)	Amb, room, hall 1, hall 2, Plate . Spring, Mod	This selects the reverb type. <ul style="list-style-type: none"> ● Amb (Ambience): Simulates an ambience mic (off-mic, placed at a distance from the sound source) used in recording and other applications. ● room (Room): Simulates the reverberation in a small room. ● hall 1 (Hall1): Simulates the reverberation in a concert hall. Provides clear and spacious reverberations. ● hall 2 (Hall2): Simulates the reverberation in a concert hall. Provides mild reverberations. ● Plate (Plate): Simulates plate reverb (a reverb unit that uses the vibration of a metallic plate). ● Spring (Spring): This simulates the sound of a guitar amp's built-in spring reverb. ● Mod (Modulate): A reverb with an added wavering effect for the hall reverberations.
TIME (Time)	0–255	Adjusts the length (time) of reverberation.
LEV (Level)	0–255	Adjusts the volume of the reverb sound.
PrDL (Pre Delay)	0–100 (ms)	Adjusts the time until the reverb sound starts to output.
LoCt (Low Cut)	FLAT, 20, 25, 31.5, 40, 50, 63, 80, 100, 125, 160, 200, 250, 315, 400, 500, 630, 800 (Hz)	Cuts the frequencies below the frequency that you set. No frequencies are cut when this is set to "FLAT".
HiCt (High Cut)	630, 800, 1k, 1.25k, 1.6k, 2k, 2.5k, 3.15k, 4k, 5k, 6.3k, 8k, 10k, 12.5k (Hz), FLAT	Cuts the frequencies above the frequency that you set. No frequencies are cut when this is set to "FLAT".
denS (Density)	0–10	Adjusts the density of the reverb sound.

MEMO

You can use the "Global Delay/Reverb SW(P.68)" setting to select whether to control the delay and reverb from the pattern parameters or from the system parameters.

Chorus

This effect adds a tiny amount of pitch modulation, creating a more spacious and thicker sound.

1. Hold down the [SHIFT] button and press pad [15] (MENU).
2. Use the [TEMPO/VALUE] knob to select "Ch", and press pad [2] (ENTER).
3. Use the [TEMPO/VALUE] knob to select the chorus type.

Value	Explanation
OFF	The chorus effect is not applied.



Value	Explanation
1	A standard chorus effect.
2	A chorus with faster modulation.
3	An effect with quick modulation that's like a rotary speaker (fast).
4	A chorus effect with more relaxed modulation.

Creating original waveforms for the oscillator (OSC DRAW)

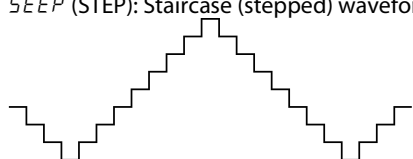
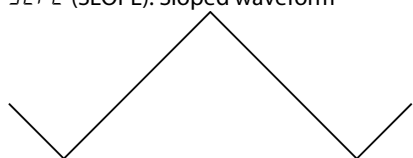

You can use a square wave oscillator to generate original waveforms.

* Pulse width modulation (PWM) is not applied.

1. Hold down the [SHIFT] button and press pad [5] (OSC DRAW).
2. Use the [TEMPO/VALUE] knob to select a parameter, and then press pad [2] (ENTER).
3. Turn the [TEMPO/VALUE] knob to edit the value.

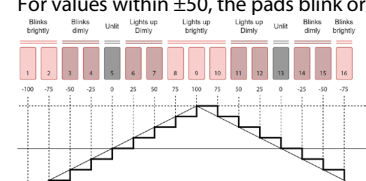
Parameter	Value	Explanation
5H (Switch)	OFF, STEP, SLOPE	Set this to STEP or SLOPE to use your original waveform. You can adjust the volume with the square wave level knob. The illustration below is an example when using the default waveform. OFF: Square wave STEP (STEP): Staircase (stepped) waveform  SLOPE (SLOPE): Sloped waveform 
		You can also edit the values by turning the OSCILLATOR [ (sawtooth wave level)] knob while holding down the [SHIFT] button.

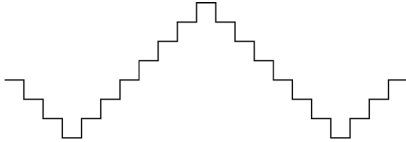
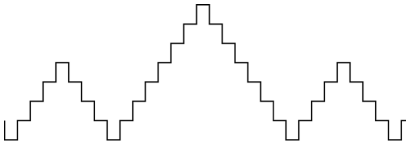
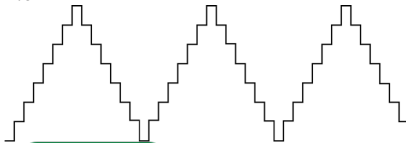

FORN (Form)	<p>---</p> <p>You can create original waveforms by dividing a single waveform cycle into 16 steps and individually editing the volume for each step.</p> <p style="color: green;">How to create original waveforms (when FORN is shown on the display)</p> <ol style="list-style-type: none"> 1. Hold down a pad from [1] to [16] corresponding to the step you want to edit, and adjust the step's level with the [TEMPO/VALUE] knob. The wave height value (from -100 to 100) is shown in the display while you press the [1]–[16] pads. The pads blink when their value is negative, go dark when their value is zero, and light up when their value is positive. For values within ±50, the pads blink or light up dimly. <div style="text-align: center;">  </div> <ol style="list-style-type: none"> 2. To exit, hold down the [SHIFT] button and press pad [1] (EXIT). The display returns to the parameter selection screen.
-----------------------	--

Parameter	Value	Explanation
PULSE (Multiply)	1.0-32.0	<p>You can synchronize the waveform you created with the <i>Form</i> parameter to a single wavelength while increasing the playback speed (pitch) to generate sound.</p> <p>With a 1.0 value, the waveform you created is as long as a single wavelength.</p> <p>The larger the value, the more that the waveform gradually begins repeating from both sides within a single wavelength, while the playback speed (pitch) of the waveform you created increases.</p> <p>Each time the setting value is increased from 2.0, 4.0, 8.0, 16.0, and 32.0 increases the pitch by one octave.</p> <p>With higher note frequencies, increasing the Multiply value too much may cause noise.</p> <p>If this happens, reduce the Multiply value or play the note at a lower octave.</p>
	1.0	
	1.5	
	2.0	
		<p>MEMO</p> <p>You can also edit the value by turning the OSCILLATOR [ (square wave level)] knob while holding down the [SHIFT] button.</p>

Chopping a waveform and emphasizing its harmonics (OSC CHOP)

You can chop the waveforms that are generated by the oscillator, and emphasize their harmonics (overtones).

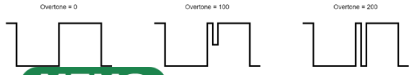
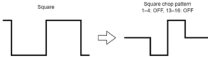
1. **Hold down the [SHIFT] button and press pad [6] (OSC CHOP).**
2. **Use the [TEMPO/VALUE] knob to select a parameter, and then press pad [2] (ENTER).**
3. **Turn the [TEMPO/VALUE] knob to edit the value.**

Parameter	Value	Explanation
<p>o u t n (Overtone)</p>	<p>0–200</p>	<p>Larger values make the chop pattern effect more intense and emphasize the harmonics. A value of 100 completely chops (mutes) the waveform. When the value is greater than 100, the waveform appears on the reverse phase side, and the harmonic components (overtones) are more prominent compared to the fundamental frequency component.</p> <div style="display: flex; align-items: center; margin-bottom: 10px;">  </div> <p style="text-align: center; background-color: #008000; color: white; padding: 2px 10px; border-radius: 10px;">MEMO</p> <p>You can also edit the value by turning the OSCILLATOR [LFO] knob while holding down the [SHIFT] button.</p>
<p>5 9 r P (Square Chop Pattern)</p> <hr/> <p>5 A B P (Saw Chop Pattern)</p> <hr/> <p>5 U b P (Sub Oscillator Chop Pattern)</p>	<p>---</p>	<p>This divides the waveform of a single cycle into 16 steps and sets the pattern (chop pattern) used to cut up the waveform. You can set a different chop pattern for each of the four waveforms (square wave, sawtooth wave, sub-oscillator and noise).</p> <p style="margin-left: 20px;">* In the case of sub-oscillator, a chop pattern is applied to the fundamental frequency of the oscillator. For example, if SUB OCT is set to “-1oc” (-1 octave), the same chop pattern appears twice in one wavelength.</p>
<p>n o i P (Noise Chop Pattern)</p>		<p>How to cut out the waves (when the respective chop pattern is shown on the display)</p> <ol style="list-style-type: none"> 1. Press pads [1]–[16] corresponding to the steps you want to edit, which makes the pads go dark. The waveform is cut out for the selected steps. When you press the pad again, the waveform returns to the previous state. <div style="display: flex; align-items: center; margin-bottom: 10px;">  </div> <div style="display: flex; align-items: center; margin-bottom: 10px;">  </div> <p>For the four waveforms, you can also combine and mix the steps (parts of the waveforms) for which the chop pattern is set to ON.</p> <p>When Overtone is set to “0”, the chop pattern has no effect. The step pads [1]–[16] blink in this case to alert you of this fact.</p> <ol style="list-style-type: none"> 2. To exit, hold down the [SHIFT] button and press pad [1] (EXIT). The display returns to the parameter selection screen.
<p>C o m b (Comb)</p>	<p>1.0–32.0</p>	<p>Sets the number of repetitions for the waveform chop pattern. With a value of 1.0, the waveform’s length is as long as the length of the chop pattern. The larger the value, the more that the pattern that was cut out repeatedly appears, which produces a metallic effect. With higher note frequencies, increasing the Comb value too much may cause noise. Also, if the note frequency exceeds 1 kHz, the OSC CHOP effect is not applied. If this happens, reduce the Comb value or play the note at a lower octave.</p> <div style="display: flex; align-items: center; margin-bottom: 10px;">  </div> <p style="text-align: center; background-color: #008000; color: white; padding: 2px 10px; border-radius: 10px;">MEMO</p> <p>You can also edit the value by turning the OSCILLATOR [SUB] knob while holding down the [SHIFT] button.</p>

Editing the notes, performance data and motions

What is a sequencer?

A system for using a sound generator to play notes (pitches and note lengths) at a certain timing based on a specified set of performance data (a "sequence") is called a "sequencer".

With the S-1 sequencer, you can handle the following performance data in units of playing time called "steps".

- **Note pitch (note number)**
- **How hard a note is played (velocity)**
- **Note length (gate time)**
- **The probability for notes to play back (probability)**
- **Playing notes in repeated succession (sub steps)**
- **Changes to tone parameters (motions)**

The S-1 offers different ways of inputting this data into the sequencer to match your needs.

Methods of input using the sequencer

Type	[▶] (PLAY) button (lit: ○ unlit: -)	[●] (REC) button (lit: ○ unlit: -)	[STEP] button (lit: ○ unlit: -)	Display indication	[1]–[16] pads	Delete all notes Pad [11] (CLEAR NOTE)	Input motion	Delete all motions Pad [12] (CLEAR MOTION)
A. Inputting with the step pads(P.34)	○/–	–	○	Tempo	Step pads <ul style="list-style-type: none"> ● Inputs/deletes a note (C5) into or from the step corresponding to the pad you pressed ● Hold down the pad to display the note number of the inputted note ● Press [D-MOTION] button while holding down a pad to switch between notes and sub steps, in order 	All notes in a pattern	Steps specified with the step pads	All motions in a pattern
B. Editing with the keyboard pads (chord)(P.36)	–	○	–	5L. (number)	Keyboard pads (white) <ul style="list-style-type: none"> ● Input/delete multiple notes into the step indicated ● Hold down a pad → show the inputted velocity (Ver. 1.02) ● Press the [D-MOTION] button while holding down a pad → switch between velocity and gate (Ver. 1.02) 	All notes in the selected step	Selected step	All motions in the selected step
C. Editing a step(P.38)	–	○	○	5L. (number)	Step pads <ul style="list-style-type: none"> ● Go to the step corresponding to the pad you pressed ● Hold down the pad to display the note 	All notes in the selected step	Selected step	All motions in the selected step

Type	[▶] (PLAY) button (lit: ○ unlit: -)	[●] (REC) button (lit: ○ unlit: -)	[STEP] button (lit: ○ unlit: -)	Display indication	[1]–[16] pads	Delete all notes Pad [11] (CLEAR NOTE)	Input motion	Delete all motions Pad [12] (CLEAR MOTION)
					number of the inputted note ● Press [D-MOTION] button while holding down a pad to switch between notes and sub steps, in order			
D. Inputting your performance in real time(P.40)	○	○	–	REC	Keyboard pads (white) ● Input multiple notes into the step that's playing	All notes in a pattern	Step currently playing	All motions in a pattern
E. Editing a step while checking what you played(P.41)	○	○	○	St. (number)	Step pads ● Go to the step corresponding to the pad you pressed ● Hold down the pad to display the note number of the inputted note ● Press [D-MOTION] button while holding down a pad to switch between notes and sub steps, in order	All notes in the selected step	Selected step	All motions in the selected step

Setting the playback range (last step)

1. Hold down the [SHIFT] button and press pad [4] (LAST).
2. Use the [TEMPO/VALUE] knob to set the number of steps in the pattern.

Setting range: 1–64

Switching between pages (steps) shown on the panel

1. While the [STEP] button is lit, use the [PORTA ON] (<) [PORTA TIME] (>) pads to switch between pages.

The step currently shown is indicated when switching.

1.15: steps 1–16, 1.32: steps 17–32, 3.48: steps 33–48, 4.64: steps 49–64

Example: when the last step is 24

[PORTA ON] (<) 1.15: steps 1–16

[PORTA TIME] (>) 1.24: steps 17–24

What's a motion?

The function that records and plays back knob operations and MIDI message-related changes such as control change and pitch bend messages received, step by step along with a pattern as it plays is called a "motion".

You can use motions to make the [FREQ] knob gradually increase the brightness of the tone, make the [DECAY] knob change the sound from staccato to legato and so on. These motions can be used when you create a pattern.

On the S-1, you can record and play back the changes you make to a maximum of eight parameters and to the pitch bend for each pattern.

MEMO

- MIDI control change and pitch bend messages can only be recorded using type D (real-time recording).

- When the parameter changes that are recorded to a motion play back, the changes in value may differ slightly from what you actually input, due to computational error.

Inputting with the step pads

1. Press the [●] (REC) button to make it go dark, and press the [STEP] button to make it light up.

The button toggles between lit and unlit each time you press it.
The white keyboard pads now function as step pads [1]–[16].

2. Press the step pad corresponding to the timing (step) at which you wish to input.

A note (C5) is input to the step you selected, and the step pad lights up.
Pressing the same step pad again deletes the note, and makes the step pad go dark.
You can use the [PORTA ON] (<) and [PORTA TIME] (>) pads to switch between pages.
Steps 1–16 ↔ steps 17–32 ↔ steps 33–48 ↔ steps 49–64

MEMO

When an external keyboard is connected, you can also input notes by pressing the step pads on this unit and then playing the desired note on your external keyboard.

Editing the notes and performance data

1. Hold down the step pad of the step that contains the performance data you want to change and press the [D-MOTION] button to select the performance data to edit.

When you long-press a step pad, the performance data inputted to that step is shown in the display.
When you press the [D-MOTION] button while holding down a step pad, the display switches in the following order.
Keep holding down the step pad to edit its value.

Item	Display	Explanation
Note number	<i>n. C5</i>	Sets the note number. Setting range: <i>C-1 – G9</i> (C-1 – G9) For instance, C#5 is shown as <i>C#5</i> . * If a chord has been input, the lowest note number in the chord is shown. When you edit this value, the other notes change accordingly.
Velocity	<i>v. 100</i>	Sets the velocity. Setting range: 1–127 * If a chord has been input, the highest velocity value used in the chord is shown. After you edit this value, the other notes are set to the same value.
Gate	<i>G. 80</i>	Sets the gate time (note length). When this is set to 100 and the same note number has been input for the next step, a tie is played. Setting range: 1–100 * If a chord has been input, the longest gate time used in the chord is shown. After you edit this value, the other notes are set to the same value.
Probability	<i>P. 100</i>	Sets the probability for notes to play back. Use the master probability setting when you want to change the probability en masse, for all steps that are set at 99 or lower. Setting range: 1–100 * The effect is applied to all notes in the step.
Sub step	<i>□</i>	Divides up the step to play. <i>□</i> : Sound is played. <i>_</i> : Sound is not played. For example, when <i>□□_</i> is indicated, the step is divided into three parts, with the first and second parts being played and the third part not played. * This affects all notes within the step. * This has no effect on steps for which notes have not been specified, or on steps that are in the middle of a tie.

2. **While holding down the step pad, use the [TEMPO/VALUE] knob to edit the setting.**

Inputting a tie

1. **To input a tie that extends to the next step, press the [HOLD] button while holding down the step pad of the step whose length you wish to change.**

When you long-press a step pad that contains a tie, the note number inputted to that step is shown in the display. You can't input a tie if a note already exists in the next step.

Deleting all notes at once within a pattern

1. **Hold down the [SHIFT] button and press pad [11] (CLEAR NOTE).**

"CLR.N" blinks in the display, and the unit waits for you to execute or cancel.

2. **To execute, press pad [2] (ENTER).**

If you decide to cancel, press pad [1] (EXIT).

Inputting a motion into a specified step

1. **Press the step pad corresponding to the step for which you want to input a motion.**
2. **Hold down the step pad and turn a knob to register the motion.**

"FULL" is indicated if the number of parameters exceeds the maximum number that can be registered in a motion. If this happens, follow the steps in "Deleting all motions in a pattern at once" to delete any unnecessary motions.

Deleting all motions in a pattern at once

1. **Hold down the [SHIFT] button and press pad [12] (CLEAR MOTION).**

"CLR.M" blinks in the display, and the unit waits for you to execute or cancel.

When the unit is waiting for you to execute or cancel, you can delete only the parameter for a specific knob from a motion by turning that knob. (This is executed when you turn the knob.)

2. **To execute, press pad [2] (ENTER).**

If you decide to cancel, press pad [1] (EXIT).

Editing with the keyboard pads (chord)

1. **Press the [STEP] button to make it go dark, and press the [●] (REC) button to make it light up.**

The button toggles between lit and unlit each time you press it.
The step number appears on the display.

2. **Use the [TEMPO/VALUE] knob to select the step to edit.**

3. **Press the note on the keyboard pad corresponding to the note you want to play, to make it light up.**

The buttons toggle between lit and unlit each time you press them, and you can input and delete notes.
You can play up to four notes at the same time.

Editing the performance data (Ver. 1.02)

1. **Hold down the keyboard pad of the note that contains the performance data you want to change, and press the [D-MOTION] button to select the performance data to edit.**

When you long-press a keyboard pad, the performance data inputted to that note is shown in the display.
Each time you press the [D-MOTION] button while holding down a keyboard pad, the display switches in the following order.
Keep holding down the keyboard pad to edit its value.

Item	Display	Explanation
Velocity	v. 100	Sets the velocity. Setting range: 1–127
Gate	G. 80	Sets the gate time (note length). When this is set to 100 and the same note number has been input for the next step, a tie is played. Setting range: 1–100

2. **While holding down the keyboard pad, use the [TEMPO/VALUE] knob to edit the setting.**

Inputting a tie (Ver. 1.02)

1. **To input a tie that extends to the next step, press the [HOLD] button while holding down the keyboard pad of the note whose length you wish to change.**

After the tie is inputted, the unit automatically advances to the next step and the step number is shown in the display.
You can't input a tie if the same note already exists in the next step.

Deleting all notes at once within a specified step

1. **Hold down the [SHIFT] button and press pad [11] (CLEAR NOTE).**

"CLRn" blinks in the display, and the unit waits for you to execute or cancel.

2. **To execute, press pad [2] (ENTER).**

If you decide to cancel, press pad [1] (EXIT).

Inputting a motion into a specified step

1. **Use the [TEMPO/VALUE] knob to select the step to edit.**

2. **Turn the knob to register a motion.**

"FULL" is indicated if the number of parameters exceeds the maximum number that can be registered in a motion.
If this happens, follow the steps in "Deleting all motions from a specified step at once" to delete any unnecessary motions.

Deleting all motions from a specified step at once

1. **Use the [TEMPO/VALUE] knob to select the step to edit.**

2. **Hold down the [SHIFT] button and press pad [12] (CLEAR MOTION).**

"CLRm" blinks in the display, and the unit waits for you to execute or cancel.

When the unit is waiting for you to execute or cancel, you can delete only the parameter for a specific knob from a motion by turning that knob. (This is executed when you turn the knob.)

3. To execute, press pad [2] (ENTER).

If you decide to cancel, press pad [1] (EXIT).

Editing a step

1. Press the [STEP] and [●] (REC) buttons to make them light up.

The buttons toggle between lit and unlit each time you press them.
The step number appears on the display.

2. Press a step pad to select the step to edit.

You can use the [PORTA ON] (<) and [PORTA TIME] (>) pads to switch between pages.
Steps 1–16 ↔ steps 17–32 ↔ steps 33–48 ↔ steps 49–64
You can also use the [TEMPO/VALUE] knob to select the steps.

Editing the note numbers and performance data

1. Hold down the step pad of the step that contains the performance data you want to change and press the [D-MOTION] button to select the performance data you edited.

When you long-press a step pad, the performance data inputted to that step is shown in the display.
When you press the [D-MOTION] button while holding down a step pad, the display switches in the following order.
Keep holding down the step pad to edit its value.

Item	Display	Explanation
Note number	<i>n.</i> C5	Sets the note number. Setting range: C–G9 (C-1 –G9) For instance, C#5 is shown as C [♯] 5. * If a chord has been input, the lowest note number in the chord is shown. When you edit this value, the other notes change accordingly.
Velocity	<i>v.</i> 100	Sets the velocity. Setting range: 1–127 * If a chord has been input, the highest velocity value used in the chord is shown. After you edit this value, the other notes are set to the same value.
Gate	<i>G.</i> 80	Sets the gate time (note length). When this is set to 100 and the same note number has been input for the next step, a tie is played. Setting range: 1–100 * If a chord has been input, the longest gate time used in the chord is shown. After you edit this value, the other notes are set to the same value.
Probability	<i>P.</i> 100	Sets the probability for notes to play back. Use the master probability setting when you want to change the probability en masse, for all steps that are set at 99 or lower. Setting range: 1–100 * The effect is applied to all notes in the step.
Sub step	<i>□</i>	Divides up the step to play. □: Sound is played. _: Sound is not played. For example, when □□_ is indicated, the step is divided into three parts, with the first and second parts being played and the third part not played. * This affects all notes within the step. * This has no effect on steps for which notes have not been specified, or on steps that are in the middle of a tie.

2. While holding down the step pad, use the [TEMPO/VALUE] knob to edit the setting.

Inputting a tie

1. To input a tie that extends to the next step, press the [HOLD] button while holding down the step pad of the step whose length you wish to change.

When you long-press a step pad that contains a tie, the note number inputted to that step is shown in the display. You can't input a tie if a note already exists in the next step.

Deleting all notes at once within a specified step

1. **Hold down the [SHIFT] button and press pad [11] (CLEAR NOTE).**

"*CLR*" blinks in the display, and the unit waits for you to execute or cancel.

2. **To execute, press pad [2] (ENTER).**

If you decide to cancel, press pad [1] (EXIT).

Inputting a motion into a specified step

1. **Use the [TEMPO/VALUE] knob to select the step to edit.**

2. **Turn the knob to register a motion.**

"*FULL*" is indicated if the number of parameters exceeds the maximum number that can be registered in a motion.

If this happens, follow the steps in "Deleting all motions from a specified step at once" to delete any unnecessary motions.

Deleting all motions from a specified step at once

1. **Use the [TEMPO/VALUE] knob to select the step to edit.**

2. **Hold down the [SHIFT] button and press pad [12] (CLEAR MOTION).**

"*CLR*" blinks in the display, and the unit waits for you to execute or cancel.

When the unit is waiting for you to execute or cancel, you can delete only the parameter for a specific knob from a motion by turning that knob. (This is executed when you turn the knob.)

3. **To execute, press pad [2] (ENTER).**

If you decide to cancel, press pad [1] (EXIT).

Inputting your performance in real time

1. **Press the [●] (REC) button to make it light up.**

The display now shows the steps (record standby mode).

2. **Press the [▶] (PLAY) button to make it light up.**

The display indicates “rEc”, and recording begins. Once the last step that’s specified in [last step](#)(P.33) is reached, the unit returns to the first step.

3. **Use the keyboard pads to record to the step that’s now playing.**

You can also record your performance from an external MIDI device.

MEMO

Use the [Count In](#)(P.69) and [Metronome](#)(P.69) features to more easily record in time with the rhythm.

Deleting all notes at once within a pattern

1. **Hold down the [SHIFT] button and press pad [11] (CLEAR NOTE).**

“CLrN” blinks in the display, and the unit waits for you to execute or cancel.

2. **To execute, press pad [2] (ENTER).**

If you decide to cancel, press pad [1] (EXIT).

Inputting a motion into the step that you’re playing

1. **Turn the knob while you play to register a motion.**

“FULL” is indicated if the number of parameters exceeds the maximum number that can be registered in a motion. If this happens, follow the steps in “Deleting all motions in a pattern at once” to delete any unnecessary motions.

Deleting all motions in a pattern at once

1. **Hold down the [SHIFT] button and press pad [12] (CLEAR MOTION).**

“CLrM” blinks in the display, and the unit waits for you to execute or cancel.

When the unit is waiting for you to execute or cancel, you can delete only the parameter for a specific knob from a motion by turning that knob. (This is executed when you turn the knob.)

2. **To execute, press pad [2] (ENTER).**

If you decide to cancel, press pad [1] (EXIT).

Editing a step while checking what you played

1. Press the [STEP] and [●] (REC) buttons to make them light up.

The buttons toggle between lit and unlit each time you press them.
The step number appears on the display.

2. Press the [▶] (PLAY) button to make it light up.

This plays back the pattern.

3. Use the [TEMPO/VALUE] knob to select the step to edit.

Editing the note numbers and performance data

1. Hold down the step pad of the step that contains the performance data you want to change and press the [D-MOTION] button to select the performance data you edited.

When you long-press a step pad, the performance data inputted to that step is shown in the display.
When you press the [D-MOTION] button while holding down a step pad, the display switches in the following order.
Keep holding down the step pad to edit its value.

Item	Display	Explanation
Note number	n. □□	Sets the note number. Setting range: □ - □□ (C-1 -G9) For instance, C#5 is shown as □□5.
		* If a chord has been input, the lowest note number in the chord is shown. When you edit this value, the other notes change accordingly.
Velocity	v. □□□	Sets the velocity. Setting range: 1-127
		* If a chord has been input, the highest velocity value used in the chord is shown. After you edit this value, the other notes are set to the same value.
Gate	G. □□	Sets the gate time (note length). When this is set to 100 and the same note number has been input for the next step, a tie is played. Setting range: 1-100
		* If a chord has been input, the longest gate time used in the chord is shown. After you edit this value, the other notes are set to the same value.
Probability	P. □□□	Sets the probability for notes to play back. Use the master probability setting when you want to change the probability en masse, for all steps that are set at 99 or lower. Setting range: 1-100
		* This affects all notes within the step.
Sub step	□	Divides up the step to play. □: Sound is played. -: Sound is not played. For example, when □□- is indicated, the step is divided into three parts, with the first and second parts being played and the third part not played.
		* This affects all notes within the step. * This has no effect on steps for which notes have not been specified, or on steps that are in the middle of a tie.

2. While holding down the step pad, use the [TEMPO/VALUE] knob to edit the setting.

Inputting a tie

1. To input a tie that extends to the next step, press the [HOLD] button while holding down the step pad of the step whose length you wish to change.

When you long-press a step pad that contains a tie, the note number inputted to that step is shown in the display. You can't input a tie if a note already exists in the next step.

Deleting all notes at once within a specified step

1. **Hold down the [SHIFT] button and press pad [11] (CLEAR NOTE).**

"CLR" blinks in the display, and the unit waits for you to execute or cancel.

2. **To execute, press pad [2] (ENTER).**

If you decide to cancel, press pad [1] (EXIT).

Inputting a motion into a specified step

1. **Use the [TEMPO/VALUE] knob to select the step to edit.**

2. **Turn the knob to register a motion.**

"FULL" is indicated if the number of parameters exceeds the maximum number that can be registered in a motion.

If this happens, follow the steps in "Deleting all motions from a specified step at once" to delete any unnecessary motions.

Deleting all motions from a specified step at once

1. **Use the [TEMPO/VALUE] knob to select the step to edit.**

2. **Hold down the [SHIFT] button and press pad [12] (CLEAR MOTION).**

"CLR" blinks in the display, and the unit waits for you to execute or cancel.

When the unit is waiting for you to execute or cancel, you can delete only the parameter for a specific knob from a motion by turning that knob. (This is executed when you turn the knob.)

3. **To execute, press pad [2] (ENTER).**

If you decide to cancel, press pad [1] (EXIT).

Deleting a group of notes

Here's how to delete a group of notes.

1. Hold down the [SHIFT] button and press pad [11] (CLEAR NOTE).

"*CLRN*" blinks, and the unit waits for you to execute or cancel.

There are two kinds of steps that are targeted for deletion, as explained in "Delete all notes" of "[Methods of input using the sequencer](#)(P.32)".

Note input type	Explanation
Types A/D	All notes in the pattern are deleted.
Types B/C/E (5L. number)	All notes in the selected step are deleted.

2. Press pad [2] (ENTER).

"*donE*" appears, and the data is deleted.

Inputting/deleting a motion

What's a motion?

When you play a pattern, you can record and play back the knob operations and MIDI message-related changes such as control change and pitch bend messages received, as "motions".

For instance, you can use motions to make the **FREQ** knob gradually increase the brightness of the tone, make the **DECAY** knob change the sound from staccato to legato and so on. These motions can be used when you create a pattern.

On the S-1, you can record and play back the changes you make to a maximum of eight parameters and to the pitch bend for each pattern.

- * MIDI control change and pitch bend messages can only be recorded using type D (real-time recording).
- * When the parameter changes that are recorded to a motion play back, the changes in value may differ slightly from what you actually input, due to computational error.

You can see and listen to how motions work by playing the following preset patterns.

- **1-04: Reverb Level**
- **1-06: Env Attack**
- **1-08: Osc Draw Multiply**
- **1-10: Reverb Level, Osc Chop Comb**
- **1-11: Filter Frequency, Env Decay**
- **1-12: LFO Rate, Env Attack, Env Release**
- **1-13: Filter Frequency, Filter Resonance**

Inputting a motion

There are three ways to input a motion, as explained in "Input motion" of "[Methods of input using the sequencer\(P.32\)](#)".

Input type	Explanation
Type A	Hold down a step pad and turn the knobs.
Types B/C/E (5k. number)	Turn the knobs when you're on the selected step.
Type D	Turn the knobs along with the step that's playing.

"FULL" is indicated if you try to record more parameters than the maximum number that can be registered in a motion.

Deleting a motion

"CLR" blinks, and the unit waits for you to execute or cancel.

There are two kinds of steps that are targeted for deletion, as explained in "Delete all motions" of "[Methods of input using the sequencer\(P.32\)](#)".

Input type	Explanation
Types A/D	All motions in the pattern are deleted.
Types B/C/E (5k. number)	All motions in the selected step are deleted.

When you press pad [2] (ENTER), "done" appears, and the data is deleted.

- * If "CLR" is blinking while the unit is waiting and you turn a knob, the parameter for only that knob is deleted.

Once the data is deleted, "CLR" is shown. If the unit can't find the parameter to delete within the pattern, "none" is indicated.

Useful sequencer functions

Copying step (COPY)

1. Press the [●] (REC) button to make it light.

The step number is shown in the display.

2. Use the [TEMPO/VALUE] knob to select the copy source step.
3. Hold down the [STEP] button and press pad [15] (MENU).
4. Use the [TEMPO/VALUE] knob to select "COPY".
5. Press pad [2] (ENTER).

"done" appears, and the data for the selected step is ready to be pasted.

MEMO

There is no effect on the pattern at this time.

Pasting a copied step (PASTE)

Follow the steps in "Copying steps (COPY)" beforehand to copy the data to be pasted.

1. Press the [●] (REC) button so the button is lit.

The step number is shown.

2. Use the [TEMPO/VALUE] knob to select the paste destination step.
3. Hold down the [STEP] button and press pad [15] (MENU).
4. Use the [TEMPO/VALUE] knob to select "PASTE".
5. Press pad [2] (ENTER).

"done" appears, and the data of the copy source step overwrites the selected step.

Inserting an empty step (Insr)

1. Press the [●] (REC) button so the button is lit.

The step number is shown.

2. Use the [TEMPO/VALUE] knob to select the insert destination step.
3. Hold down the [STEP] button and press pad [15] (MENU).
4. Use the [TEMPO/VALUE] knob to select "Insr".
5. Press pad [2] (ENTER).

"done" is shown, and the empty step is inserted into the selected step, which shifts all steps afterwards by one step forward.

Copying all steps to double the length (DUPL)

1. Press the [●] (REC) button so the button is lit.

The step number is shown.

2. Hold down the [STEP] button and press pad [15] (MENU).
3. Use the [TEMPO/VALUE] knob to select "DUPL".
4. Press pad [2] (ENTER).

"done" appears, and the steps from step 1 through the last step are copied after the last step, doubling the length.

Changing the step length (P.SCL)

1. Hold down the [STEP] button and press pad [15] (MENU).
2. Use the [TEMPO/VALUE] knob to select "P.SCL".
3. Press pad [2] (ENTER).

Specify the step length (1_8: eighth notes– 1_32: thirty-second notes, 4L: quarter-note triplets– 16L: sixteenth-note triplets).

MEMO

You can also edit the value by holding down the [PATTERN] button and turning the [TEMPO/VALUE] knob.

Saving a pattern

1. Hold down the [SHIFT] button and press pad [16] (WRITE).
2. Use the [TEMPO/VALUE] knob to select what to save.

Data to save	Explanation
Ptn	Saves the currently selected pattern.
ALL	Saves all patterns.

3. Press pad [2] (ENTER).

"done" appears, and the pattern is saved.

NOTE

Once the power is turned off, any unsaved patterns are reset to their last saved state.

Copying, initializing and reloading a pattern

Copying the patterns

Copies the current pattern to a specified pattern.

1. Hold down the [SHIFT] button and press pad [15] (MENU).
2. Use the [TEMPO/VALUE] knob to select "COPY", and press pad [2] (ENTER).
3. Use the [TEMPO/VALUE] knob to select the copy destination number.
4. To execute, press pad [2] (ENTER).

To cancel, press pad [1] (EXIT).

Initializing a pattern

This shows how to initialize the currently selected pattern (sequence and tone).

1. Hold down the [SHIFT] button and press pad [15] (MENU).
2. Use the [TEMPO/VALUE] knob to select "init", and press pad [2] (ENTER).

MEMO

The pattern you initialized returns to its previous state once you turn off the power.

To save the pattern, follow the steps in "Saving a pattern(P.47)".

Reloading a pattern

This shows how to restore the currently selected pattern to its last saved state.

Reload all of the pattern (Reload All)

1. Hold down the [SHIFT] button and press pad [15] (MENU).
2. Use the [TEMPO/VALUE] knob to select "rLod", and press pad [2] (ENTER).

Reload the tone (Reload Sound)

1. Hold down the [SHIFT] button and press pad [15] (MENU).
2. Use the [TEMPO/VALUE] knob to select "rL.Sd", and press pad [2] (ENTER).

MEMO

Press the [SHIFT] button, pad [1] (EXIT) and the [POLY] pad at the same time to reload the sound.

Reloading the sequence (Reload Sequence)

1. Hold down the [SHIFT] button and press pad [15] (MENU).
2. Use the [TEMPO/VALUE] knob to select "rL.Sq", and press pad [2] (ENTER).

Other useful functions

- Playing arpeggios(P.49)
- Using the manual function(P.52)
- Looping specific steps (step loop)(P.53)
- Transposing (key transpose)(P.54)
- Controlling the parameters by tilting this unit (D-MOTION)(P.55)
- Adding a rising or falling sound to your performance (Riser)(P.57)
- Using the metronome(P.58)
- Setting the probability for the entire pattern (master probability)(P.59)
- Using global delay/reverb(P.60)

Playing arpeggios

On the S-1, you can automatically arpeggiate the chords you play on the keyboard pad. This is the arpeggiator function.

The arpeggiator on the S-1 works when you press multiple keyboard pads at the same time. When you press a single note using a non-legato technique (by pressing the next keyboard pad only after you've released the previous pad), the arpeggio plays normally. In this way, you can make the arpeggios play depending on how you press the pads.

Turning the arpeggiator on

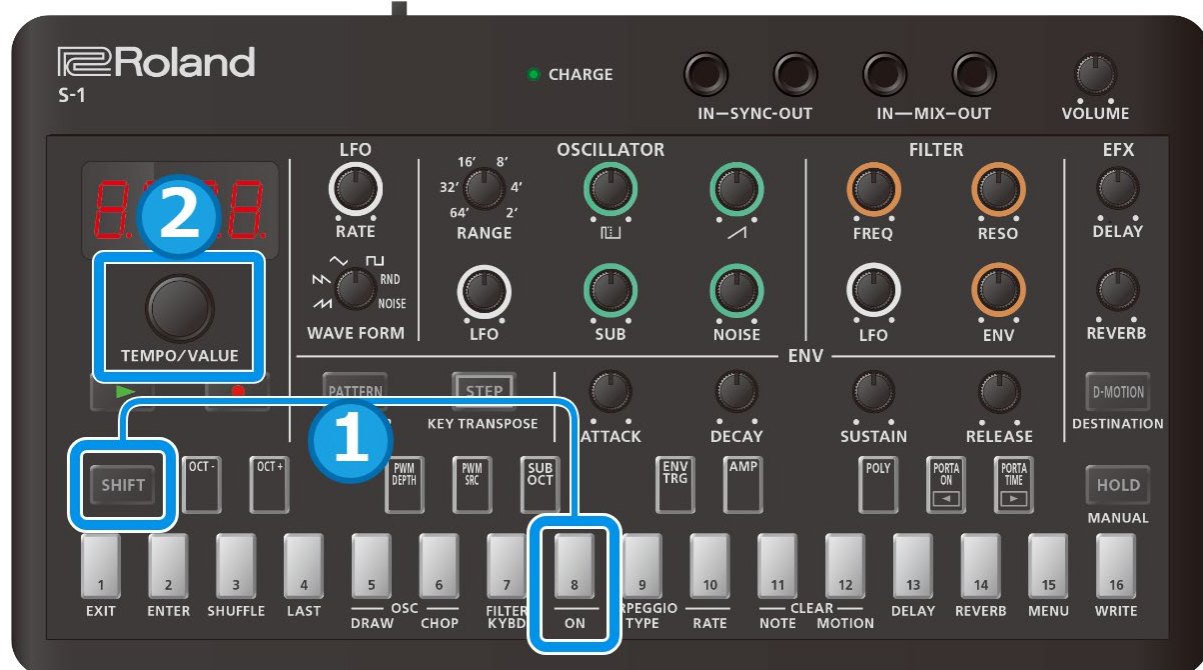

1. Hold down the [SHIFT] button and press pad [8] (ARPEGGIO ON).
2. Use the [TEMPO/VALUE] knob to select "0n".

MEMO

To turn the arpeggiator off, select "0FF" in step 2.

Press pad [8] (ARPEGGIO ON) repeatedly while holding down the [SHIFT] button to toggle the arpeggio on/off. (Ver. 1.02)

Selecting the type of phrase played by the arpeggiator

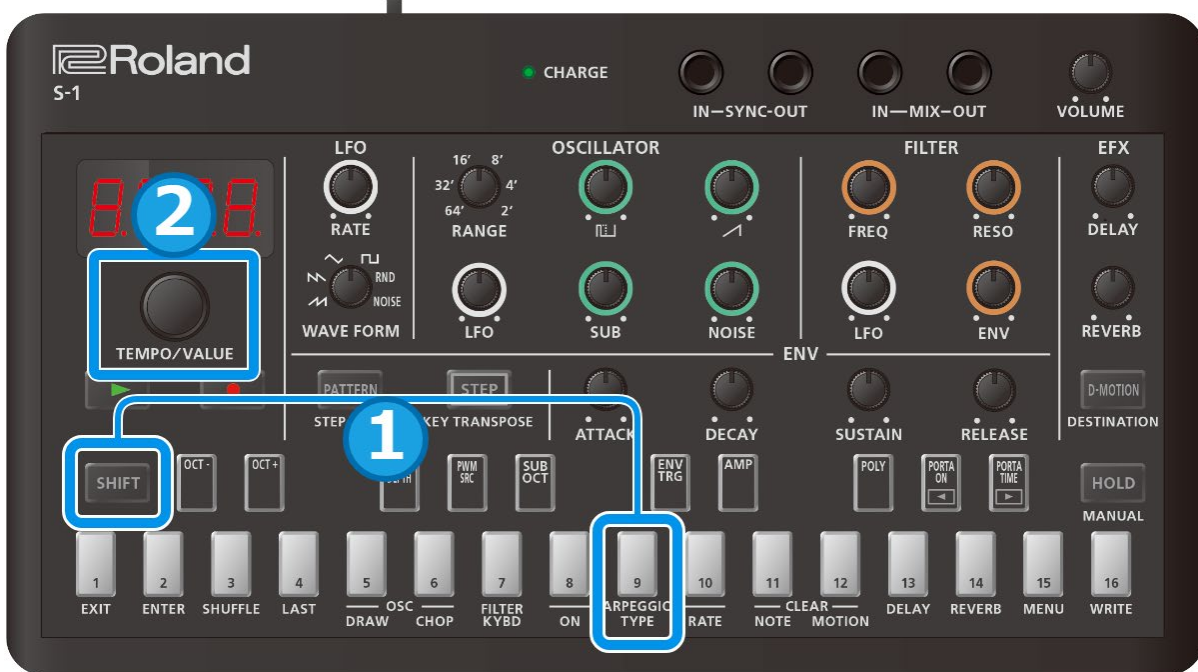

1. Hold down the [SHIFT] button and press pad [9] (ARPEGGIO TYPE).
2. Use the [TEMPO/VALUE] knob to select the arpeggio type.

TYPE	Explanation
<i>UP</i>	Up
<i>dn</i>	Down
<i>UPdn</i>	Up&Down
<i>UP2</i>	Up 2oct
<i>dn2</i>	Down 2oct
<i>UPdn2</i>	Up&Down 2oct
<i>rnd</i>	Random
<i>rnd2</i>	Random 2oct

Selecting the note lengths played by the arpeggiator

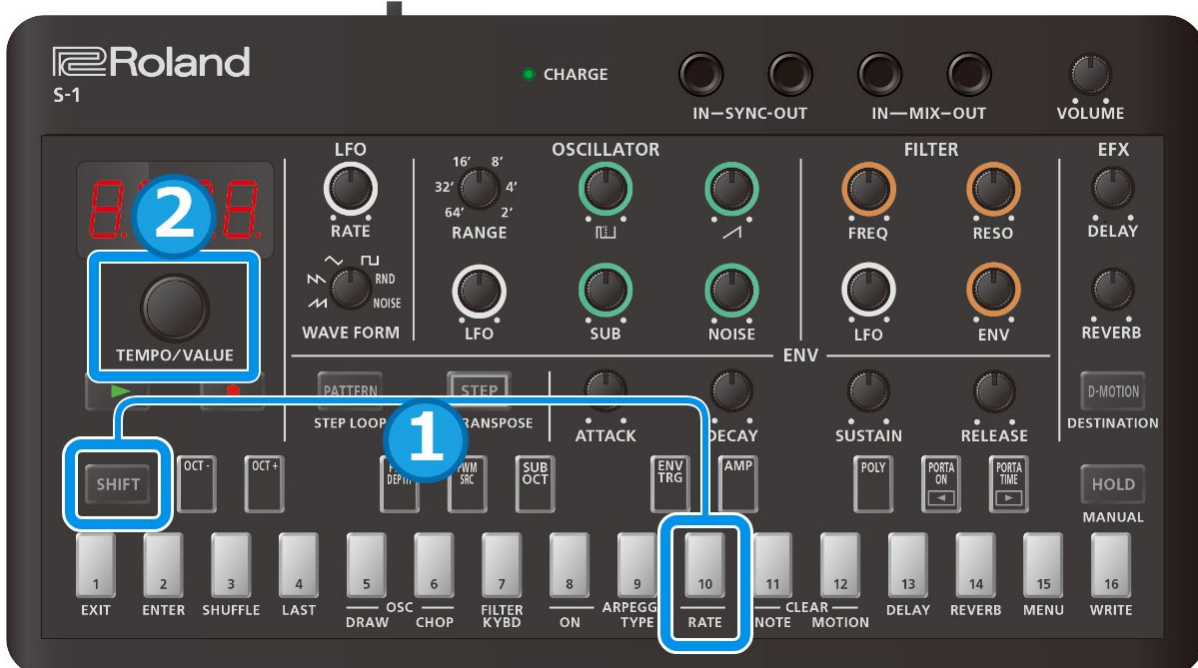

1. Hold down the [SHIFT] button and press pad [10] (ARPEGGIO RATE).
2. Use the [TEMPO/VALUE] knob to select the arpeggio note length.

RATE	Explanation
1_4	Quarter note
1_8	Eighth note
1_16	Sixteenth note
1_32	Thirty-second note
8t	Eighth-note triplet
16t	Sixteenth-note triplet
32t	Thirty-second-note triplet

MEMO

If the timing you use when playing each note of the chord is considerably off, the arpeggio might not start playing right away. Play the notes of the chord at the same time.

However, when you want the arpeggio notes to play smoothly from the top, such as when using the “Up” or “Down” setting, it may help to play the notes of the chords from the lowest note or the highest note first.

The arpeggio keeps repeating only for as long as you hold down the keyboard pads (this works differently when the hold function is on).

The envelope (which triggers when the arpeggio plays) changes, depending on the POLY mode settings in the controller section and the ENV TRG (envelope trigger)(P.20) settings in the ENV section.

Below are some examples of how ENV TRG works, when the POLY mode is set to “Mono”.

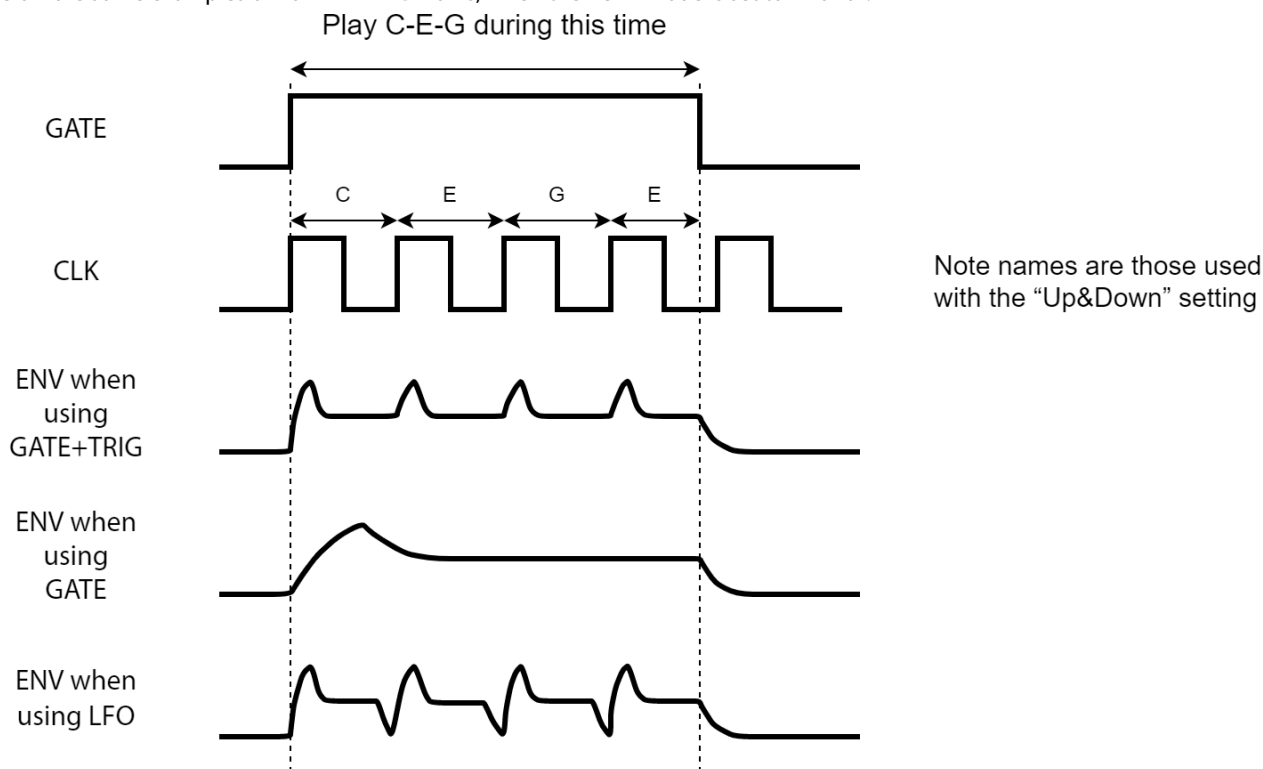

When you use the arpeggio when ENV TRG is set to “GATE” and the [SUSTAIN] knob reaches the setting of the decaying sound (0), the sound stops as the envelope ends.

Using the arpeggiator together with the hold function

When you press the [HOLD] button to make it light up while an arpeggio is playing, the arpeggio keeps playing even after you take your finger off the keyboard pad.

If you press another keyboard pad in this state to specify a different chord, the arpeggiator plays using the new chord.

Using the arpeggiator together with portamento

When Portamento Mode is “ON”: the arpeggiator plays back with portamento applied to the notes.

When Portamento Mode is “AUTO”: the arpeggio plays with portamento applied, but only when ENV TRG is set to “GATE”.

When Portamento Mode is “OFF”: the arpeggiator plays back without applying portamento to the notes.

Using the manual function

What's the manual function?

The manual function applies the position of all of the knobs to the tone.

This is useful in situations like when you want to create a tone from scratch.

MEMO

When you want to create a sound from scratch, we recommend that you either select an empty pattern from 2-01 onward, or follow the steps in "[Initializing a pattern](#)(P.48)".

Press the [SHIFT] + [HOLD] buttons to enter manual mode. When doing so, the current knob positions are applied to the tone of the selected pattern.

Only the parameters accessible from the top panel knobs are applied to the pattern.

- * The knob settings are not applied to the parameters that are set in combination with the [SHIFT] button ([Knob assignments](#)(P.70)).

Looping specific steps (step loop)

You can make a selected step or steps play back in a loop during pattern playback.

You can make more than one step play back in a loop at the same time.

1. Press the [▶] (PLAY) button to start playback (the button lights up).

2. Hold down the [SHIFT] button and press the [PATTERN] button.

The [PATTERN] button blinks, and the unit enters step loop mode.

3. Keep pressing the step pads [1]–[16] that you want to play repeatedly.

The steps you selected play repeatedly.

4. To exit, press the [PATTERN] button.

Transposing (key transpose)

You can transpose the pitches played by the keyboard pads and the sequencer.

1. Hold down the [SHIFT] button and press the [STEP] (KEY TRANSPOSE) button.
2. Turn the [TEMPO/VALUE] knob to edit the value.

Parameter	Value
Key transpose	-60+60

At this time, you can also hold down the [SHIFT] button and press a keyboard pad to make this setting within a range of -12 to +12. (Ver. 1.02)

This is useful when you want to quickly transpose the pitch while a pattern is playing.

You can also control this from within the menu.

1. Hold down the [SHIFT] button and press pad [15] (MENU).
2. Use the [TEMPO/VALUE] knob to select “*Trn*” (Key transpose), and press pad [2] (ENTER).
3. Turn the [TEMPO/VALUE] knob to edit the value.

Parameter	Value
<i>Trn</i> (Key transpose)	-60+60

Controlling the parameters by tilting this unit (D-MOTION)

The S-1 features D-MOTION, which lets you control the tones according to the angle at which this unit is tilted.

You can add various effects by tilting this unit while you play.

You can see and listen to how D-MOTION works by playing the preset patterns 1-01 through 1-16.

When using this function, firmly grip both sides of this unit and be careful not to bend the connected cables too much.

Using D-MOTION

1. Press the [▶] (PLAY) button to start pattern playback (the button lights up).
2. Firmly grip both sides of this unit and press the [D-MOTION] button with your right thumb or other finger.
3. While holding down the [D-MOTION] button, tilt the unit back and forth (pitch) or left-right (roll).

The tone changes as you tilt the unit.

When doing this, make sure not to drop the unit, and make sure that the connected cables aren't bent too much.

4. To return the tone to its original state, release your finger from the [D-MOTION] button.

Configuring D-MOTION

1. Hold down the [SHIFT] button and press the [D-MOTION] button.

The settings screen is shown in the display.

2. Use the [TEMPO/VALUE] knob to select a parameter, and then press pad [2] (ENTER).
3. Turn the [TEMPO/VALUE] knob to edit the value.

Configure the parameters that you want to change when you tilt this unit from left to right (roll), or when you tilt the unit forward and backward (pitch).

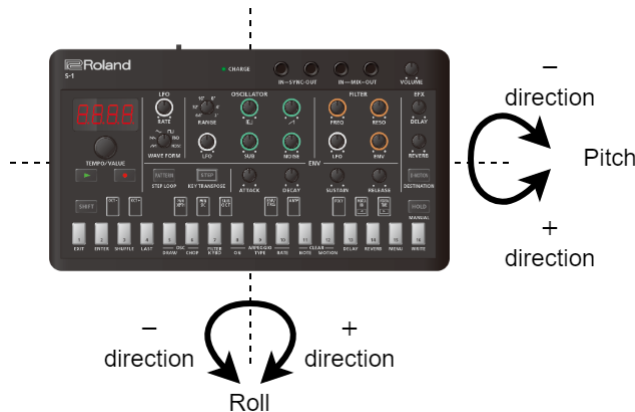

roll (Roll)	<p>OFF: No parameters are changed.</p> <p>Mod (Modulation): A cyclical change is applied to the pitch or filter according to how the unit is tilted, just like when MIDI modulation data is received. (The effect is the same for both positive and negative directions.) Adjust the effect speed with the LFO [RATE] knob(P.5), and the depth with LFO Modulation Depth(P.25).</p> <p>FREQ (Frequency): Raises or lowers the cutoff point centered on the current value of the [FREQ] knob, according to the tilt of this unit.</p> <p>RESO (Resonance): Emphasizes or dampens the frequencies around the cutoff point according to the tilt of this unit, centered on the current value of the [RESO] knob.</p> <p>PBnd (Pitch Bend): Tilting this unit applies pitch bend changes to the pitch or to the filter according to how this unit is tilted, just like when MIDI pitch bend data is received. Use Oscillator Bend Sens(P.25) or Filter Bend Sens(P.25) to adjust the effect depth.</p>
Ptch (Pitch)	<p>PAN (Pan): Changes the left-right stereo position of the sound according to how this unit is tilted, just like when MIDI pan data is received.</p> <p>EXP (Expression): Changes the volume according to how this unit is tilted (only in the negative direction), just like when MIDI expression data is received.</p> <p>DLV (Delay Level): Changes the delay volume according to how this unit is tilted, centered on the current value of the DELAY knob.</p> <p>RLV (Reverb Level): Changes the reverb volume according to how this unit is tilted, centered on the current value of the REVERB knob.</p>

Adding a rising or falling sound to your performance (Riser)

What's a "Riser"?

A Riser is a rising sound that's added to a song as the song builds in excitement and reaches its climax. In contrast, a "Downer" is a falling sound.

Use the [NOISE] knob to control both the riser and downer effects.

- When the [NOISE] knob is set to minimum (r. 0) or maximum (d. 100), the riser sound is muted.
- You can add excitement to the sequencer's performance by making the riser go up from minimum → midpoint (r. 100) as the song moves towards its climax, and then go down from midpoint → maximum (d. 100) once the song has reached its climax.
- Although the riser produces an intermittent sound over the range from the minimum to midpoint [NOISE] knob settings, it works differently depending on the Riser Mode. The riser works the same from the midpoint to maximum setting (a continuous falling sound).
- You can change the knob position without outputting the riser sound if you hold down the [SHIFT] button while turning the [NOISE] knob, after you turn the [NOISE] knob from minimum to maximum (the muted state).

This lets you output the riser sound at the position you like.

- After you turn the [NOISE] knob to a setting besides minimum or maximum while holding down the [SHIFT] button and then release the [SHIFT] button, the riser sound is output immediately according to the knob position. (Ver.1.02)

This lets you prepare for the downer state while continuing the previous riser state, so that you can switch to the downer state just by taking your finger off the [SHIFT] button.

Configuring the Riser

1. Hold down the [SHIFT] button and press pad [15] (MENU).
2. Use the [TEMPO/VALUE] knob to select a parameter, and then press pad [2] (ENTER).
3. Turn the [TEMPO/VALUE] knob to edit the value.

Riser parameters (in the menu)

Parameter	Value	Explanation
r. 5.11d (Riser Mode)	OFF	Use the [NOISE] knob to adjust the noise level. When the Riser Mode is set to anything besides OFF, you can use the [NOISE] knob to control the riser.
	SYN	The riser sound is output intermittently upbeat of the quarter notes, in time with the tempo.
	QU 10	The intervals between riser sound output get faster as you turn the [NOISE] knob clockwise.
	QU Pn	The riser sound pans faster from left to right as you turn the [NOISE] knob clockwise.
r. 5.5 (Riser Resonance)	0- 100	Adjusts the shrillness of the riser sound.
r. 5.5h (Riser Shape)	0- 100	Adjusts the envelope shape of the riser sound. 0: sawtooth wave 100: square wave
r. 5.1u (Riser Level)	0- 100	Adjusts the volume of the riser sound.

MEMO

- You can switch between Riser Mode settings each time you press pad [1] (EXIT) and pad [2] (ENTER) at the same time while holding down the [SHIFT] button.
- When the riser function is enabled (when Riser Mode is set to any value besides "OFF"), the output state of the riser sound according to the position of the [NOISE] knob is not saved to the pattern.
- The riser sound is muted when you switch to a pattern for which the riser function is disabled.
When you switch to a pattern for which the riser function is enabled, the position of the [NOISE] knob just before you do this is applied to the riser sound. (Note that the riser sound's mute state is inherited from the previous pattern.)
- To keep the riser going even after switching patterns, Riser Mode must be set to a value besides "OFF" in both patterns.
By doing this, you can connect the actions you make with the [NOISE] knob, which means turning the [NOISE] knob clockwise from the minimum setting as the pattern moves towards its end during playback (the riser effect), and turning the [NOISE] knob clockwise from its midpoint all the way to maximum when the unit switches to the next pattern (the downer effect).

Using the metronome

Configuring the metronome

Here's how to change how the metronome plays and its volume.

1. Hold down the [SHIFT] button and press pad [15] (MENU).
2. Use the [TEMPO/VALUE] knob to select the parameters below, and then press pad [2] (ENTER).

Parameter	Value	Explanation
MTR O (Metronome)	OFF	Always off
	REC (Rec)	Turns on only when recording
	REC&PLAY (Rec&Play)	Turns on during recording and playback
MTR L (Metronome Level)	0-100	Sets the volume of the metronome.

Setting the length (the number of beats) of the count-in

Here's how to set the length (the number of beats) of the count-in for recording.

1. Hold down the [SHIFT] button and press pad [15] (MENU).
2. Use the [TEMPO/VALUE] knob to select "Cnt. l", and press pad [2] (ENTER).

Parameter	Value	Explanation
Cnt. l (Count In)	OFF, 2-4	Sets the length (the number of beats) of the count-in for recording.

The metronome or count-in click plays in quarter-note intervals.

The metronome timing is reset at the beginning of the pattern. (Ver. 1.02)

Setting the probability for the entire pattern (master probability)

This shows how to set the probability for the notes in the entire pattern to play (the master probability).

The master probability value is added or subtracted from the probabilities that each step plays. Because of this, you can use the master probability to lower the chance that the step sounds even more, for steps on which you've already individually lowered the probability.

You can control the improvisatory nature of the sound by adding or subtracting notes from the pattern that's playing.

- * To do this, you must set the probability for each step.
- * Master probability works on steps for which the probability is set to 99 or lower. (Steps always sound if their probability is 100.)

1. Hold down the [SHIFT] button and press pad [15] (MENU).
2. Use the [TEMPO/VALUE] knob to select "*Prb*", and press pad [2] (ENTER).
3. Turn the [TEMPO/VALUE] knob to edit the value.

Parameter	Value	Explanation
<i>Prb</i> (Master Probability)	-100–100 (in units of 10)	Sets the overall probability for notes to sound in a pattern.

MEMO

You can also set this by holding down the [STEP] button and turning the [TEMPO/VALUE] knob.

Using global delay/reverb

What's global delay/reverb?

On this unit, you can select whether to control delay and reverb by using the pattern parameters or by using the system parameters.

"Global delay/reverb" refers to using the system parameters to control the delay and reverb.

The global delay/reverb parameters are saved in the system parameters.

1. **Hold down the [SHIFT] button and press pad [15] (MENU).**
2. **Use the [TEMPO/VALUE] knob to select "*GL.d.r*" (Global Delay/Reverb SW), and press pad [2] (ENTER).**
3. **Select either "*OFF*" or "*On*".**

Parameter	Value	Explanation
<i>GL.d.r</i> (Global Delay/Reverb SW)	<i>OFF</i>	The settings are saved per pattern, and the tail of the delay/reverb is muted while switching patterns.
	<i>On</i>	As the system settings are given priority, the tail of the delay/reverb continues to sound even while you switch between patterns.

Both the delay and reverb parameters can be configured in the function page.

For details on the parameters, refer to "[Creating sounds\(P.12\)](#)" - "[EFX section\(P.26\)](#)".

Connecting to a computer or mobile device

You can transmit and receive audio and MIDI data by connecting a USB cable from your computer or mobile device (smartphone or tablet) to this unit.

You don't need to install a device driver on your computer or mobile device to do this, since this unit supports USB Audio Device Class 2.0 specs.

- * Note that data can't be directly transmitted/received between this unit and your computer or mobile device if you're connecting through a USB hub.
- * Do not use a USB cable that is designed only for charging. Cables used for charging only cannot transmit data.
- * We cannot guarantee the correct functionality of all apps.
- * Android devices are not guaranteed to work with this unit.

Turning AIRA LINK mode off

1. **Hold down the [SHIFT] button and press pad [15] (MENU).**
2. **Use the [TEMPO/VALUE] knob to select "AIR LINK", and press pad [2] (ENTER).**

The AIRA LINK mode setting value is shown.

3. **Use the [TEMPO/VALUE] knob to select "OFF", and press pad [1] (EXIT).**

The display returns to the parameter selection screen in the menu.

4. **Press pad [1] (EXIT) again.**
5. **After making the setting, turn the power off and then on again.**

Connecting to your computer

Use a USB Type-C to USB Type-A cable (included) or a cable that uses USB Type-C on both sides (included) to connect this unit to your computer.

Connecting to a mobile device

For iOS devices with Lightning connectors

Power up the unit in battery-only mode.

1. **While holding down pad [1] (EXIT), turn on the power.**
This powers up the unit in battery-only mode.
2. **Use an Apple-manufactured USB adaptor (such as the Lightning-USB Camera Adapter, the Lightning to USB 3 Camera Adapter and so on) as a converter for the iOS device's connector.**
3. **Use a USB cable (USB Type-C to USB Type-A cable, included) to connect this unit to the USB adaptor.**

- * Commercially available USB Type-C to Lightning conversion cables cannot be used.

For iOS devices with a USB Type-C port

Connect your iOS device to this unit using a USB cable with USB Type-C connectors on both ends (commercially available).

When doing so, you can power this unit from your iOS device.

Restoring the factory settings (factory reset)

Here's how to return the S-1 to its factory-set state.

1. **While holding down the [HOLD] button, turn on the power.**

"*F R E E*" is indicated, and the [D-MOTION] button blinks.

To cancel the factory reset, turn off the power.

2. **Press the [D-MOTION] button.**

This executes the factory reset.

3. **Once "*d r n E*" is displayed and all buttons are blinking, turn the power of the S-1 off and then on again.**

Backing up and restoring data

Backup

1. **Connect your computer to the S-1's USB port via USB cable.**
2. **While holding down the [▶] (PLAY) button, turn on the power.**

The drive on this unit takes 1–2 minutes to get ready. The keyboard pads light up to show the progress.

3. **Open the "S-1" drive on your computer.**

The backup files are located in the "BACKUP" folder on the "S-1" drive.

4. **Copy the backup files to the computer.**

Copy all of the files in the "BACKUP" folder.

5. **Once copying is finished, eject the USB drive from your computer.**

Windows

Right-click on the "S-1" icon and click "Eject".

MacOS

Drag the "S-1" icon to the Trash icon in the Dock.

6. **Turn the S-1 off.**

Restoring

1. **Execute steps 1–3 in "Backup", and then open the "S-1" drive on your computer.**

The drive on this unit takes 1–2 minutes to get ready.

The keyboard pads light up to show the progress.

2. **Copy the backup files to the "RESTORE" folder on the "S-1" drive.**
3. **Once copying is finished, eject the USB drive from your computer.**
4. **Press the [HOLD] button.**

This restores the data.

5. **Once you see the message "dONE", turn off the S-1.**

Using the functions

1. Hold down the [SHIFT] button and press a keyboard pad.

This lets you configure and execute a variety of function parameters.

List of functions

Controller	Explanation
[OCT-] pad	Switches between octaves for the keyboard pads.
[OCT+] pad	By holding down the [SHIFT] button and pressing the [OCT-] pad and the [OCT+] pad, you can reset the octave to zero. (Ver. 1.02)
[PWM DEPTH] pad	<p>When PWM SRC is $\overline{P}Rn$ (Manual): Adjusts the pulse width value (0–255).</p> <p>When PWM SRC is LFO or Env (Envelope): Adjusts how much the LFO or envelope varies the pulse width (0–255).</p> <p>What's "pulse width"? Pulse width refers to the value that indicates the percentage of the upper part of the square wave width compared to the whole square wave. If the waveform's upper and lower width is not equal, this is called an asymmetrical square wave.</p>
[PWM SRC] pad	<p>Env (Envelope): Alters the pulse width envelope.</p> <p>$\overline{P}Rn$ (Manual): Sets the PWM DEPTH value of the pulse width.</p> <p>LFO: Uses the LFO to cyclically alter the pulse width.</p>
[SUB OCT] pad	<p>Sets the sub-oscillator octave type.</p> <p>- $2o\overline{P}$: Two octaves lower (narrower pulse width, asymmetrical)</p> <p>- $2oc$: Two octaves lower</p> <p>- $1oc$: One octave lower</p>
[ENV TRG] pad	<p>Sets what causes the envelope to trigger.</p> <p>LFO: When you keep playing the keyboard, the envelope is repeatedly triggered with each LFO cycle.</p> <p>$GR\overline{E}$ (Gate): The envelope is triggered each time you play a new note on the keyboard. The envelope is not retriggered when you play legato.</p> <p>$Gr\overline{G}$ (Gate+Trig): The envelope is triggered each time you press a key.</p>
[AMP] pad	<p>Controls the envelope to make time-based changes to the sound.</p> <p>$GR\overline{E}$ (Gate): Sound is played at a set volume only while a key is played.</p> <p>Env (Env): The sound follows the envelope settings you make with the [ATTACK], [DECAY], [SUSTAIN] and [RELEASE] knobs.</p>
[POLY] pad	<p>Selects the sound mode.</p> <p>$\overline{M}ono$ (Mono): Monophonic Plays in single-note mode.</p> <p>$Unison$ (Unison): Unison Stacks multiple tones to play a layered note.</p> <p>$Poly$ (Poly): Polyphonic Lets you play more than one tone at the same time (up to four voices).</p> <p>Chd (Chord): Chord Plays voices 2–4 at the same time for each note that you play, according to the parameter settings below.</p> <p>Press pad [2] (ENTER) while "Chd" is shown in the display to configure the following parameters.</p> <p>$u25H$ (Voice 2 SW): Turns the sound of voice 2 on/off.</p> <p>$u2K5$ (Voice 2 Key Shift): Transposes the key of voice 2 (range: -12–0–12).</p> <p>$u35H$ (Voice 3 SW): Turns the sound of voice 3 on/off.</p> <p>$u3K5$ (Voice 3 Key Shift): Transposes the key of voice 3 (range: -12–0–12).</p> <p>$u45H$ (Voice 4 SW): Turns the sound of voice 4 on/off.</p> <p>$u4K5$ (Voice 4 Key Shift): Transposes the key of voice 4 (range: -12–0–12).</p>
[PORTA ON] pad	<p>Sets how portamento works.</p> <p>\overline{OFF}: Portamento is not applied.</p> <p>\overline{ON}: Portamento is always applied.</p> <p>$Auto$ (Auto): Portamento is only applied when you play in a legato style. Note that portamento is not applied when the arpeggiator is playing.</p>
[PORTA TIME] pad	Adjusts the time over which the portamento effect changes the pitch (0–255).
Pad [1] (EXIT)	Exits the menu.
Pad [2] (ENTER)	Confirms the editing of a value or the selection of an item.
Pad [3] (SHUFFLE)	Configures the shuffle settings (-90–0–90).

Controller	Explanation
Pad [4] (LAST)	Sets the length (the last step) of the selected pattern (1–64).
Pad [5] (OSC DRAW)	<p>You can use a square wave oscillator to generate and play original waveforms. For details, refer to “Creating original waveforms for the oscillator (OSC DRAW)(P.29)”.</p> <p>* Pulse width modulation (PWM) is not applied.</p> <p><i>S</i>H (Switch) <i>F</i>o<i>r</i>Π (Form) <i>Π</i>U<i>L</i>L (Multiply)</p>
Pad [6] (OSC CHOP)	<p>Use this to chop the waveforms that are generated by the oscillator to create radical harmonics (overtones). For details, refer to “Chopping a waveform and emphasizing its harmonics (OSC CHOP)(P.31)”.</p> <p><i>o</i>u<i>t</i>n (Overtone) <i>S</i>q<i>r</i>P (Square Chop Pattern) <i>S</i>A<i>w</i>P (Saw Chop Pattern) <i>S</i>U<i>b</i>P (Sub Oscillator Chop Pattern) <i>n</i>o<i>i</i>P (Noise Chop Pattern) <i>C</i>o<i>m</i>b (Comb)</p>
Pad [7] (FILTER KYBD)	Changes the filter cutoff point according to the pitch (0–255).
Pad [8] (ARPEGGIO ON)	Turns the arpeggiator on/off.
Pad [9] (ARPEGGIO TYPE)	<p>Selects the type of phrase played by the arpeggiator.</p> <p><i>U</i>P (Up) <i>d</i>o<i>w</i>n (Down) <i>U</i>P<i>d</i>o<i>w</i>n (Up&Down) <i>U</i>P2 (Up 2oct) <i>d</i>o2 (Down 2oct) <i>U</i>d2 (Up&Down 2oct) <i>r</i>and (Random) <i>r</i>and2 (Random 2oct)</p>
Pad [10] (ARPEGGIO RATE)	<p>Selects the note lengths played by the arpeggiator.</p> <p><i>1</i>_4 (Quarter note) <i>1</i>_8 (Eighth note) <i>1</i>_16 (Sixteenth note) <i>1</i>_32 (Thirty-second note) 8t (Eighth-note triplet) 16t (Sixteenth-note triplet) 32t (Thirty-second-note triplet)</p>
Pad [11] (CLEAR NOTE)	<p>Erases all notes in the selected pattern.</p> <p>When a step is selected, this deletes only the notes for that step. Once “<i>C</i>L<i>r</i>n” blinks in the display, press pad [2] (ENTER) to execute. “<i>d</i>o<i>n</i>E” is shown once the operation is finished.</p>
Pad [12] (CLEAR MOTION)	<p>Erases all motions in the selected pattern.</p> <p>When a step is selected, this deletes only the motions for that step. Once “<i>C</i>L<i>r</i>Π” blinks in the display, press pad [2] (ENTER) to execute. “<i>d</i>o<i>n</i>E” is shown once the operation is finished.</p> <p>If you turn a knob before executing this operation, and a knob parameter is recorded in the motion, “<i>C</i>L<i>r</i>” is shown, and only that parameter is erased.</p> <p>If a knob parameter is not recorded, “<i>n</i>o<i>n</i>E” is indicated.</p> <p>What’s a motion?</p> <p>Motions are used to record your operations (such as when turning the knobs) into the sequencer and play them back. On the S-1, you can record eight types of knob motions (or MIDI control change messages corresponding to the parameters) and MIDI pitch bend data for each pattern.</p>
Pad [13] (DELAY)	<p>Configures the delay.</p> <p><i>d</i>S<i>y</i>n (Delay Sync): Synchronizes the delay time to the tempo (OFF, ON). <i>t</i>ime (Time): Sets the delay time.</p> <ul style="list-style-type: none"> When Delay Sync is OFF: Specifies the time (1–740 ms). When Delay Sync is ON: Specifies a note length (128, 64t, 128d, ...4t, 8d, 1_4). <p><i>L</i>Ev (Level): Adjusts the volume of the delay sound (0–255). <i>F</i>d<i>b</i>b (Feedback): Adjusts the amount of feedback (repetition), from 0 to 255. <i>L</i>ack (Low Cut): Cuts the frequencies below the frequency that you set (FLAT, 20–800 Hz). No frequencies are cut when this is set to “<i>F</i>L<i>A</i>T”.</p>

Controller	Explanation
	<p><i>H i.Ct</i> (High Cut): Cuts the frequencies above the frequency that you set (630–12.5 kHz, FLAT). No frequencies are cut when this is set to "<i>FLAT</i>".</p>
Pad [14] (REVERB)	<p>Controls the reverb.</p> <p><i>TYPE</i>: This selects the reverb type.</p> <ul style="list-style-type: none"> ● <i>AMB</i> (Ambience): Simulates an ambience mic (off-mic, placed at a distance from the sound source) used in recording and other applications. ● <i>ROOM</i> (Room): Simulates the reverberation in a small room. ● <i>HALL 1</i> (Hall1): Simulates the reverberation in a concert hall. Provides clear and spacious reverberations. ● <i>HALL 2</i> (Hall2): Simulates the reverberation in a concert hall. Provides mild reverberations. ● <i>PLATE</i> (Plate): Simulates plate reverb (a reverb unit that uses the vibration of a metallic plate). ● <i>SPRING</i> (Spring): This simulates the sound of a guitar amp's built-in spring reverb. ● <i>MOD</i> (Modulate): A reverb with an added wavering effect for the hall reverberations. <p><i>TIME</i>: Adjusts the length (time) of reverberation (0–255).</p> <p><i>LEV</i> (Level): Adjusts the volume of the reverb sound (0–255).</p> <p><i>Pr.dL</i> (Pre Delay): Adjusts the time until the reverb sound starts to output (0–100 ms).</p> <p><i>Lo.Ct</i> (Low Cut): Cuts the frequencies below the frequency that you set (FLAT, 20–800 Hz). No frequencies are cut when this is set to "<i>FLAT</i>".</p> <p><i>H i.Ct</i> (High Cut): Cuts the frequencies above the frequency that you set (630–12.5 kHz, FLAT). No frequencies are cut when this is set to "<i>FLAT</i>".</p> <p><i>denS</i> (Density): Adjusts the density of the reverb sound (0–10).</p>
Pad [15] (MENU)	Displays the menu.
Pad [16] (WRITE)	Saves the pattern.

MEMO

You can switch between the values in order by repeatedly pressing the following pads while holding down the [SHIFT] button. (Ver. 1.02)

- [8] (ARPEGGIO ON)
- [PWM SRC]
- [SUB OCT]
- [ENV TRG]
- [AMP]
- [POLY]
- [PORTA ON]

Using the menus

1. Hold down the [SHIFT] button and press step pad [15] (MENU).
2. Use the [TEMPO/VALUE] knob to select the item, and then press pad [2] (ENTER).

Menu list

Item	Value	Explanation
vvl (Volume) (*1)	0-127	Sets the pattern's volume.
Modd (LFO Modulation Depth) (*1)	0-255	Sets the depth of the effect (vibrato or growl) applied to the OSC or FILTER from the LFO section when modulation is used.
band (Oscillator Bend Sens) (*1)	0-240	Sets how much the OSC changes the pitch when you operate the pitch bend. (120: ±1oct, 240: ±2oct)
bandF (Filter Bend Sens) (*1)	0-255	Sets how much the cutoff point changes the filter when you operate the pitch bend.
n5nd (Noise Mode) (*1)	Selects the type of noise.	
	<i>pink</i>	Pink noise
	<i>white</i>	White noise
r5nd (Riser Mode) (*1)	A riser is a rising sound that's added to a song as the song builds in excitement and reaches its climax. In contrast, a "downer" is a falling sound. Use the [NOISE] knob to control both the riser and downer effects. When the [NOISE] knob is set to minimum ("r-0") or maximum ("d.0"), the riser sound is muted. You can add excitement to the sequencer's performance by making the riser go up from minimum → midpoint (r. 100) as the song moves towards its climax, and then go down from midpoint → maximum (d. 0) once the song has reached its climax. Although the riser produces an intermittent sound over the range from the minimum to midpoint [NOISE] knob settings, it works differently depending on the Riser Mode. The riser works the same from the midpoint to maximum setting (a continuous falling sound). You can change the knob position without outputting the riser sound if you hold down the [SHIFT] button while turning the [NOISE] knob, after you turn the [NOISE] knob from minimum to maximum (the muted state). This lets you output the riser sound at the position you like.	
	<i>off</i>	With this setting, the [NOISE] knob is used to adjust the noise level. When the Riser Mode is set to anything besides OFF, you can use the [NOISE] knob to control the riser.
	<i>sync</i>	The riser sound is output intermittently upbeat of the quarter notes, in time with the tempo.
	<i>qu. cw</i>	The intervals between riser sound output get faster as you turn the [NOISE] knob clockwise.
	<i>qu. pan</i>	The riser sound pans faster from left to right as you turn the [NOISE] knob clockwise.
r5r5 (Riser Resonance) (*1)	0-100	Adjusts the shrillness of the riser sound.
r5sh (Riser Shape)	0-100	Adjusts the envelope shape of the riser sound. 0: sawtooth wave 100: square wave
r5lv (Riser Level) (*1)	0-100	Adjusts the volume of the riser sound.
LFOd (LFO Mode) (*1)	Selects how fast the LFO changes.	
	<i>norm</i>	Normal mode
	<i>fast</i>	Fast mode
LFOs (LFO Sync) (*1)	<i>off, on</i>	Sets whether to sync the LFO rate to the tempo. When this is set to "On", the LFO Mode is disabled.

Item	Value	Explanation
LFOE (LFO Key Trigger) (*1)	OFF, On	Sets whether the LFO is reset when a note-on message is received or played.
Cho (Chorus) (*1)	OFF, 1-4	Selects the chorus type. 1: A standard chorus effect. 2: A chorus with faster modulation. 3: Adds an effect similar to a rotary speaker (fast). 4: A chorus effect with more relaxed modulation.
TrAn (Transpose) (*1)	-60-60	Transposes the sounds made by the sound generator.
PSCl (Pattern Scale) (*1)	1_8 1_16 1_32 8t 16t 32t	Sets the length of a single step in the pattern. 1_8: Eighth note 1_16: Sixteenth note 1_32: Thirty-second note 8t: Eighth-note triplet 16t: Sixteenth-note triplet 32t: Thirty-second-note triplet * You can also switch between settings by holding down the [PATTERN] button and turning the [TEMPO/VALUE] knob.
MPrb (Master Probability)	-100-100 (in units of 10)	Changes the probability that notes are played by adding/subtracting the master probability to/from the probability that each step plays (which is set for each step in the pattern). * You can also set this by holding down the [STEP] button and turning the [TEMPO/VALUE] knob.
nPri (Note Priority)	LAST, LOW	When the POLY function is set to "Mono", "Uni", "Chd" for single note input, and ENV TRG is set to a value "LFO" or "GATE", this sets whether the last notes are given priority (Last) or the lowest notes (Low).
GLdr (Global Delay/Reverb SW)	OFF, On	Selects whether to control delay and reverb by using the pattern parameters or by using the system parameters. When this is "OFF", the delay or reverb is muted when you switch patterns, as the delay/reverb settings may vary with each pattern. When this is "On", the system settings are used, and the delay or reverb sound carries over even when you switch between patterns.
dLNd (Delay Level Mode)	PRE, POST	Sets which level to adjust when the [DELAY] knob is used, the input level (Pre) or the output level (Post). With the "PRE" setting, the delay sound fades out smoothly when you turn down the [DELAY] knob; and with the "POST" setting, the delay sound is instantly muted when you turn down the [DELAY] knob.
SClE (Sync Clock)	1, 2, 3, 4, 6, 8, 12, 24	Sets the number of sync clocks per beat.
CH (MIDI Channel)	1-16	Specifies the MIDI transmit/receive channel.
SYnE (MIDI Clock Sync)	AUTO Int MIDI USB	Sets which synchronization signal is used by this unit. AUTO (Auto): Inputted clocks are accepted. Int (Int): The unit operates according to its internal clock. MIDI: Only MIDI input is accepted. USB (USB): Only USB MIDI input is accepted. * Note that when an external device is connected to the SYNC IN jack, the unit always synchronizes to the clocks that are inputted to the SYNC IN jack.
Thru (MIDI Thru)	OFF, On	Sets whether to output the messages that are input from the MIDI IN jack to the MIDI OUT jack (ON) or not (OFF).
THPC (Tx Program Change)	OFF, On	Sets whether program change messages are transmitted or not when the pattern changes.
rHPC (Rx Program Change)	OFF, On	Sets whether the pattern changes when a program change message is received.
PECh (Program Change Channel)	1-16	Sets the MIDI channel for transmitting/receiving the program change messages used to change patterns.

Item	Value	Explanation
uELo (Key Velocity)	1-127	Sets the keyboard velocity.
tUNE (Tune)	433.0-448.0	Sets the master tuning. Default value: 440.0 Hz
USbd (USB Direct Out)	OFF, 1-127	Configures the volume of the signal output to USB. OFF: Uses the VOLUME knob's setting. 1-127: Sets the volume apart from the VOLUME knob's setting.
ALnk (AIRA Link) (*2)	OFF, On	Set this to "On" when connecting a device via USB that is compatible with AIRA LINK, such as the MX-1. Otherwise, leave this at the "OFF" setting. The setting takes effect after the unit is powered off and on again.
Cnt. I (Count In)	OFF, 2-4	Sets the length (the number of beats) of the count-in for recording.
Metro (Metronome)	OFF, rEC (Rec), rCPL (Rec&Play)	Sets whether and when the metronome plays. OFF: Always off rEC (Rec): Turns on only when recording rCPL (Rec&Play): Turns on during recording and playback
MetL (Metronome Level)	0-100	Sets the metronome level.
dMt (D-Motion Latch)	OFF, On	Sets whether to use latch operations for the [D-MOTION] button or not. Default value: OFF OFF: D-MOTION turns "ON" while you press the button (momentary operation). On: D-MOTION toggles between ON/OFF each time you press the button (latch operation).
COPY (Pattern Copy)		Copies the current pattern to a specified pattern. The copy destination number is shown in the display. Use the [TEMPO/VALUE] knob to select the copy destination number. <ul style="list-style-type: none"> ● Press pad [2] (ENTER) to copy. ● If you want to cancel, press pad [1] (EXIT).
int (Pattern Initialize)		Initializes the currently selected pattern (performance data and tones).
rLod (Reload All)		Reloads the pattern. rLod (Reload All): The selected pattern is restored to its last saved state.
rL5d (Reload Sound)		rL5d (Reload Sound): The tone of the selected pattern is restored to its last saved state.
rL59 (Reload Sequence)		* You can also hold down the [SHIFT] button and press the [1] + [POLY] pads to do this. rL59 (Reload Sequence): The performance data of the selected pattern is restored to its last saved state.





*1: The settings are made for the currently selected pattern (and can be saved for each pattern).

*2: When using with another port besides the USB HOST 3 port on the MX-1, the unit starts up in battery-only mode. To use battery-only mode, turn on the power while holding down pad [1] (EXIT).

Knob assignments

Characters shown in quotes indicate the first character that's displayed.

"(#number)" indicates the MIDI controller number.

Section	Knob	Normal operations	Operate while holding down the [SHIFT] button
LFO	[RATE] knob	LFO RATE ("r" [when LFO SYNC: OFF], #3)	LFO MODE (#79)
	[WAVE FORM] knob	LFO WAVE FORM (#12)	LFO SYNC ("5", #106) (Ver.1.02)
OSCILLATOR	[RANGE] knob	OSC RANGE ("r", #14)	FINE TUNE (#76)
	[LFO] knob	OSC LFO ("L", #13)	OSC CHOP OVERTONE ("o", #103)
	 knob	OSC  LEVEL ("5", #19)	OSC PULSE WIDTH ("H", #15) (when OSC DRAW SW is OFF) or OSC DRAW MULTIPLY ("M", #102) (when OSC DRAW SW is STEP or SLOPE)
		 knob	OSC  LEVEL ("5", #20)
	[SUB] knob	OSC SUB LEVEL ("o", #21)	OSC CHOP COMB ("L", #104)
	[NOISE] knob	OSC NOISE LEVEL ("r", #23) (when RISER MODE is OFF) or RISER ON+RISER CONTROL ("r" / "d") (when RISER MODE is "ON")	NOISE MODE #78 (when RISER MODE is "OFF") or Hold RISER CONTROL (Ver. 1.02) ("r" / "d") (when RISER MODE is "ON")
FILTER	[FREQ] knob	FILTER FREQUENCY ("F", #74)	
	[RESO] knob	FILTER RESONANCE ("r", #71)	
	[LFO] knob	FILTER LFO ("L", #25)	
	[ENV] knob	FILTER ENVELOPE ("E", #24)	FILTER KEYBOARD FOLLOW ("L", #26)
ENV	[ATTACK] knob	ENV ATTACK ("A", #73)	
	[DECAY] knob	ENV DECAY ("d", #75)	
	[SUSTAIN] knob	ENV SUSTAIN ("5", #30)	
	[RELEASE] knob	ENV RELEASE ("r", #72)	
EFX	[DELAY] knob	DELAY LEVEL ("d", #92)	DELAY TIME ("L", #90)
	[REVERB] knob	REVERB LEVEL ("r", #91)	REVERB TIME ("L" (when DELAY SYNC is "OFF"), #89)
Value displayed only		Operate while holding down the [STEP] button or operate while holding down the [PATTERN] button (Ver. 1.02)	Operate while holding down the [PATTERN] and [STEP] buttons

Controller	Explanation
[SHIFT] button + pad [1] (EXIT) + pad [2] (ENTER)	Riser mode
[PATTERN] button + [TEMPO/VALUE] knob	Pattern scale
[STEP] button + [TEMPO/VALUE] knob	Master probability
[SHIFT] button + pad [1] (EXIT) + [POLY] pad	Reload sound ("r.L.5d")
[SHIFT] button + [OCT-] pad + [OCT+] pad	Octave Reset (Ver.1.02)
[SHIFT] button + [●] (REC) button	Metronome mode(Ver.1.02)

Main Specifications

Maximum Polyphony	4 voices
User Patterns	64
Step Sequencer	64 steps
Effects	DELAY, REVERB, CHORUS
Display	7 segments, 4 characters (LED)
Connectors	SYNC (IN, OUT) jacks: Miniature phone type MIX (IN, OUT) /PHONES jacks: Stereo miniature phone type MIDI (IN, OUT) jacks: Stereo miniature phone type USB port: USB Type-C® (Audio, MIDI)
Power Supply	Lithium-ion battery Obtained via USB port (USB bus power)
Current Draw	500 mA
Expected battery life under continuous use	Approx. 4.5 hours * These figures will vary depending on the actual conditions of use.
Expected battery charging time	Approx. 3 hours * To charge the unit, use the USB port of a computer or a commercially available USB power supply adaptor (5 V, 500 mA or higher).
Dimensions	188 (W) x 106 (D) x 36.2 (H) mm 7-7/16 (W) x 4-3/16 (D) x 1-7/16 (H) inches
Weight (including batteries)	305 g 11 oz
Accessories	Leaflet "Read Me First" USB Type-C to USB A cable

* This document explains the specifications of the product at the time that the document was issued. For the latest information, refer to the Roland website.

Signal flow

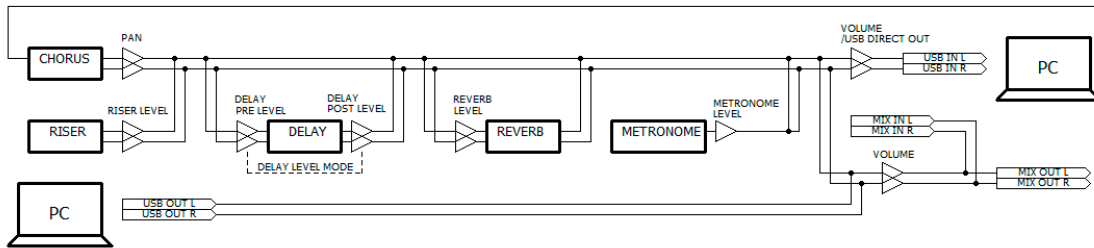
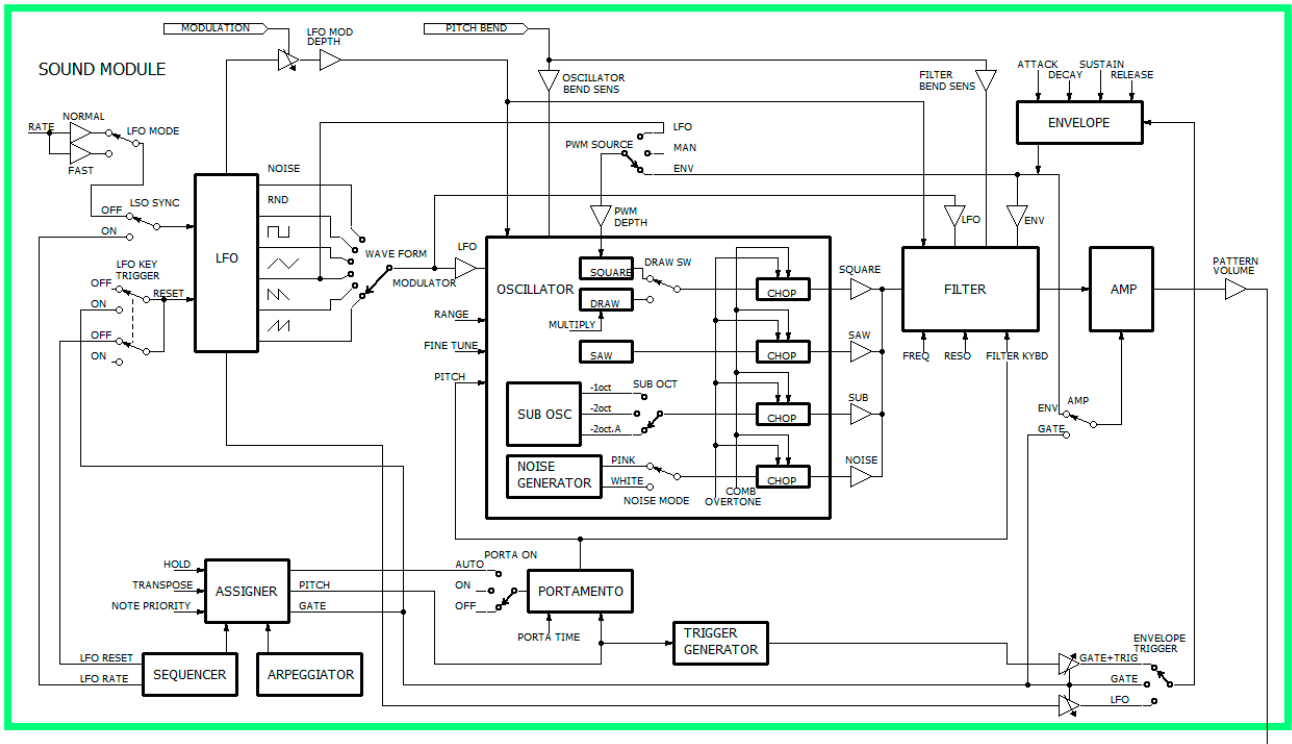

MIDI implementation chart

AIRA Compact

Model: S-1







Date: Apr. 18, 2023

Version 1.02

Function		Transmitted	Recognized	Remarks
Basic Channel	Default	3 (Synth), 16 (Program Change)	3 (Synth), 16 (Program Change)	Memorized
	Changed	1–16	1–16	
Mode	Default	Mode 3	Mode 3	
	Messages Altered	x x	x x	
Note Number	: True Voice	0–127	0–127	
Velocity	Note On	o	o	
	Note Off	x	x	
After Touch	Key's	x	x	
	Channel's	x	x	
Pitch Bend		x	o	
Control Change	1	x	o	For details, refer to "Control change list".
	3	o	o	
	5	o	o	
	10	x	o	
	11	x	o	
	12–31	o	o	
	64, 65	x	o	
	71–76	o	o	
	77	x	o	
	78–83	o	o	
	85–87	o	o	
89–93	o	o		
102–107	o	o		
Program Change	: True Number	o 0–63	o 0–63	
		x	x	
System Exclusive		x	x	
System Common	: Song Position	x	x	
	: Song Select	x	x	
	: Tune Request	x	x	
System Real Time	: Clock	o	o	
	: Start	o	o	
	: Continue	x	x	
	: Stop	o	o	
Aux Message	: All Sound Off	o	o	Transmitted: MIDI OFFLINE
	: Reset All Controllers	x	o	
	: All Notes Off	x	o	
	: Omni Mode Off	x	x	
	: Omni Mode On	x	x	
	: Mono Mode On	x	x	
	: Poly Mode On	x	x	
	: Active Sensing	o	o	
	: System Reset	x	x	

Control change list

Control Change	Explanation
1	Modulation Wheel
3	LFO RATE (LFO [RATE] knob)
5	PORTAMENTO TIME ([SHIFT] button + [PORTA TIME] pad)

Control Change	Explanation
10	Pan
11	Expression Pedal
12	LFO WAVE FORM (LFO [WAVE FORM] knob)
13	OSC LFO (OSCILLATOR [LFO] knob)
14	OSC RANGE (OSCILLATOR [RANGE] knob)
15	OSC PULSE WIDTH ([SHIFT] button + [PWM DEPTH] pad) ([SHIFT] + OSCILLATOR  knob)
16	OSC PWM SOURCE ([SHIFT] button + [PWM SRC] pad)
17	LFO MODULATION DEPTH ([SHIFT] button + pad [15] (MENU): LFO Modulation Depth)
18	OSC BEND SENS ([SHIFT] button + pad [15] (MENU): Oscillator Bend Sens)
19	OSC  LEVEL (OSCILLATOR  knob)
20	OSC  LEVEL (OSCILLATOR  knob)
21	OSC SUB OSC LEVEL (OSCILLATOR [SUB] knob)
22	OSC SUB OCT TYPE ([SHIFT] button + [SUB OCT] pad)
23	OSC NOISE LEVEL (OSCILLATOR [NOISE] knob)
24	FILTER ENVELOPE (FILTER [ENV] knob)
25	FILTER LFO (FILTER [LFO] knob)
26	FILTER KEYBOARD FOLLOW ([SHIFT] button + pad [7] (FILTER KYBD) pad) ([SHIFT] button + FILTER [ENV] knob)
27	FILTER BEND SENS ([SHIFT] button + pad [15] (MENU): Filter Bend Sens)
28	AMP ENVELOPE MODE SW ([SHIFT] button + [AMP] pad)
29	ENV TRIGGER MODE ([SHIFT] button + [ENV TRG] pad)
30	ENV SUSTAIN (ENV [SUSTAIN] knob)
31	PORTAMENTO MODE ([SHIFT] button + [PORTA ON] pad)
64	Damper Pedal
65	PORTAMENTO
71	FILTER RESONANCE (FILTER [RESO] knob)
72	ENV RELEASE (ENV [RELEASE] knob)
73	ENV ATTACK (ENV [ATTACK] knob)
74	FILTER FREQUENCY (FILTER [FREQ] knob)
75	ENV DECAY (ENV [DECAY] knob)
76	FINE TUNE ([SHIFT] + OSCILLATOR [RANGE] knob)
77	TRANSPOSE SW ([SHIFT] button + [STEP] (KEY TRANSPOSE) button)
78	NOISE MODE ([SHIFT] button + pad [15] (MENU): Noise Mode) ([SHIFT] + OSCILLATOR [NOISE] knob)
79	LFO MODE ([SHIFT] button + pad [15] (MENU): LFO Mode) ([SHIFT] + LFO [RATE] knob)
80	POLY MODE ([SHIFT] button + [POLY] pad: Poly Mode)
81	CHORD VOICE 2 SW ([SHIFT] button + [POLY] pad: Voice 2 SW)
82	CHORD VOICE 3 SW ([SHIFT] button + [POLY] pad: Voice 3 SW)
83	CHORD VOICE 4 SW ([SHIFT] button + [POLY] pad: Voice 4 SW)
85	CHORD VOICE 2 KEY SHIFT ([SHIFT] button + [POLY] pad: Voice 2 Key Shift)
86	CHORD VOICE 3 KEY SHIFT ([SHIFT] button + [POLY] pad: Voice 3 Key Shift)
87	CHORD VOICE 4 KEY SHIFT ([SHIFT] button + [POLY] pad: Voice 4 Key Shift)
89	REVERB TIME ([SHIFT] + [REVERB] knob)
90	DELAY TIME ([SHIFT] + [DELAY] knob)
91	REVERB LEVEL ([REVERB] knob)
92	DELAY LEVEL ([DELAY] knob)
93	CHORUS ([SHIFT] button + pad [15] (MENU): Chorus)
102	OSC DRAW MULTIPLY ([SHIFT] button + pad [5] (OSC DRAW): MULTIPLY) ([SHIFT] + OSCILLATOR  knob)
103	OSC CHOP OVERTONE ([SHIFT] button + pad [6] (OSC CHOP): OVERTONE) ([SHIFT] + OSCILLATOR [LFO] knob)
104	OSC CHOP COMB ([SHIFT] button + pad [6] (OSC CHOP): COMB) ([SHIFT] + OSCILLATOR [SUB] knob)
105	LFO KEY TRIGGER ([SHIFT] button + pad [15] (MENU): LFO Key Trigger)
106	LFO SYNC ([SHIFT] button + [MENU] pad: LFO Sync) ([SHIFT] + LFO [WAVE FORM] knob) (Ver.1.02)
107	OSC DRAW SW ([SHIFT] button + pad [5] (OSC DRAW): SW) ([SHIFT] + OSCILLATOR  knob)

S-1

Owner's Manual

02

©2023 Roland Corporation